

UniGroup Too and UniGroup

GSA Price List – February 2026



This price list is based upon Haworth's December 2025 commercial pricing.

GENERAL SERVICES ADMINISTRATION FEDERAL SUPPLY SERVICE

Authorized Federal Supply Scheduled Price List (Catalog) Office Furniture, Wood Casegoods and Tables

(FSC Group 71, Part I, FSC Classes 7105, 7110, 7125 and 7195)

Contract No: GS-O3F-057DA | Contract Period: February 28, 2026 – February 7, 2031 | Business: Large

Contractor: Haworth, Inc. | One Haworth Center | Holland, MI 49423-9576 | 1.616.393.3000



Electronic Update Page – UniGroup Too Price List

- The table below lists all of the updates and addendums added to this price list since the original version was created.
- All **Update** pages will replace the existing pages within the document.
- All **New** pages will be placed at the back of the document.

Link	Date	Pages	Description
Click Here	April 2026	116	Update – 90° Corner for Expanded Top Finish Cap Removed



This Haworth North American price book contains US list prices.
Canadian customers can convert the US list price into their Canadian equivalent by going to www.Haworth.com/Canada to find the current Canadian multipliers. These multiplier factors allow you to convert the US list price into a Canadian list price.

HAWORTH, INC.

GENERAL SERVICES ADMINISTRATION

FEDERAL ACQUISITION SERVICES

Authorized Federal Supply Schedule Furniture (FSC Group 71, FSC Classes 7105, 7110, 7125 and 7195)

Contract Number:	GS-03F-057DA
Contract Start Date:	February 28, 2026
Contract End Date:	February 7, 2031
Contractor:	HAWORTH, INC. One Haworth Center Holland, MI 49423-9576 1-616-393-3000 http://www.haworth.com/government
Business Size:	Large

Information for Ordering Activities I-FSS-600

Online access to Haworth's Authorized Federal Supply Schedule contract ordering information, terms and conditions, and up-to-date product and discount listing can be found at GSA Advantage, eLibrary link [here](#).



This Page Intentionally Left Blank

UniGroup Too Price List

Includes pricing, catalog numbers, finish codes/availability, specification requirements, line art, dimensions, and specification tips for UniGroup Too.

UniGroup Too Panels and Accessories

UniGroup Panels and Accessories

Retrofit Kits

Clerestory Kits

Electrical Components

Electrical and Cable Management Accessories

Adaptable Worksurfaces

Worksurface Supports

Worksurface Accessories

Adaptable Upper Storage

Wall Mount Components

Lighting

Table of Contents

Price List

Statement of Line 8

UniGroup Too Panels

- Basic Monolithic Panel — No Power 18
- Basic Monolithic Panel — Powered 21
- Fabric Monolithic Panel — No Power 24
- Fabric Monolithic Panel — Powered 27
- Monolithic Panel with Full-Height Inserts — No Power 30
- Monolithic Panel with Full-Height Inserts — Powered 33
- Monolithic Panel with Segmented Inserts — No Power 36
- Monolithic Panel with Segmented Inserts — Powered 39
- Monolithic Panel Core without Insert(s) — No Power 42
- Monolithic Panel Core without Insert(s) — Powered 44
- Glazed Monolithic Panel — No Power 46
- Glazed Monolithic Panel — Powered 48
- Base Insert 50
- Upper Inserts 51
- Fabric Add-On Panel 52
- Glazed Add-On Panel 53

Panel Accessories

- Sliding Door 54
- Filler Post — Sliding Door 54

Swing Door

- Single Door 55

Panel Accessories

- 90° Full-Height Finish Post — Square Painted Top Cap 56
- 90° Variable-Height Finish Post — Square Painted Top Cap 56
- 90° Power Connector Cover — Square Profile 56
- 120° Full-Height Finish Post — Square Painted Top Cap 57
- 120° Variable-Height Finish Post — Square Painted Top Cap 57
- 120° Power Connector Cover 57
- 180° Full-Height Finish Post — Square Painted Top Cap 58
- 180° Variable-Height Finish Post — Square Painted Top Cap 58
- 180° Power Connector Cover 59
- 180° Vertical Cover only, (no top cap or base raceway cover) 59
- 90° Square Painted Top Cap for 2-Way, 3-Way, 4-Way 60
- 120° Square Painted Top Cap for 2-Way or 3-Way 60
- UniGroup Too Top Cap Aligner 61
- UniGroup Too Top Cap End Plug 61
- Base Raceway End Cap 61
- Full Height Side Trim Rail — for use with Add-On Panels 62
- Side Trim Rail 62
- Hinges 63
- Wall Track 63
- Wall Mount Kit 63
- T-Mount Kits 64
- All-Purpose Hook 64
- Seismic Anchoring Bracket 64
- Friction Pad 64

UniGroup Panels

- Monolithic Panel with Steel Top Cap — No Power 65
- Monolithic Panel with Steel Top Cap — Powered 68
- Basic Monolithic Panel with Steel Top Cap — No Power 71
- Basic Monolithic Panel with Steel Top Cap — Powered 74
- Open Frame Panel with Steel Top Cap — No Power 77
- Open Frame Panel with Steel Top Cap — Powered 79
- Glazed Monolithic Panel with Steel Top Cap — No Power 81
- Glazed Monolithic Panel with Steel Top Cap — Powered 83
- Fabric Add-On Panel 85
- Glazed Add-On Panel 87

Swing Door with Steel Top Cap

- Single Door 89

Panel Accessories

- 90° Finish Post — for Steel Top Cap — Painted Surface 90
- 90° Power Connector Cover 90
- 180° Power Connector Cover — Radius Profile 90
- 180° Finish Post — for Steel Top Cap — Painted Surface 91
- Steel Top Cap for 3-Way and 4-Way 91
- Full-Height Side Trim Rails — for use with Add-On Panels 92
- Side Trim Rail 92
- Hinges 93
- Wall Track 93
- Wall Mount Kit 93
- T-Mount Kit — Center and End Conditions 94
- All-Purpose Hook 94
- Seismic Anchoring Bracket 94
- Friction Pad 94

Panel Accessories – Retrofit Kits

- Square Painted Top Caps 95
- Trim Strip for UniGroup Fabric and Glazed Add-On Panels 95
- 90° Full-Height Finish Post — Square Painted Top Cap 96
- 90° Variable-Height Finish Post — Square Painted Top Cap 96
- 120° Full-Height Finish Post — Square Painted Top Cap 97
- 120° Variable-Height Finish Post — Square Painted Top Cap 97
- 180° Full-Height Finish Post — Square Painted Top Cap 98
- 180° Variable-Height Finish Post — Square Painted Top Cap 98
- Square Painted Top Caps 99
- 90° Full-Height Finish Post — Square Painted Top Cap 99
- 90° Variable-Height Finish Post — Square Painted Top Cap 99
- 180° Full-Height Finish Post — Square Painted Top Cap 100
- 180° Variable-Height Finish Post — Square Painted Top Cap 100

Clerestory Kits

- Straight Track Kit 102
- 2-Way Connector Kit 102
- 3-Way Connector Kit 102
- 4-Way Connector Kit 102
- End Kit 102

Electrical Components

- Base Feed Module – Hardwire Connection 103
- Single Circuit Base Feed Module – Receptacle Connection with Power Cord 103
- Base Feed Module — Concealed Hardwire Connection 104
- Raised Floor Base Feed Module 105
- Internal Power Base AI Feed 105
- Wall Feed Field Wired 1 Port 106
- Infeed Harness 106
- Top Feed Module — UniGroup Too Only 107
- Top Feed Module — UniGroup Only 108
- Flexible Power Connector — Panel-to-Panel 109
- Flexible Power Connector — Straight Span 110
- Connector Assembly – 12” Pass-Through 110
- Duplex Receptacle – 15 Amp 111
- Raceway Retrofit Kit 111
- Duplex Receptacle – 20 Amp 112
- Raceway Cover – 20 Amp 112
- Ported Raceway Covers 113
- Base Raceway End Cap 114

Electrical and Cable Management Accessories

- Cable Management Pole — One Channel 115
- Cable Management Pole — Two Channels 115
- Power Breaker Marker 115
- Expanded Top Cap Raceway – UniGroup Only 116
- Expanded Top Finish Cap – UniGroup Only 116

Table of Contents

Electrical Components — Hardwire

Base Feed Kit	118
Dual Power Access Raceway Kit — 4"-High Base Raceway	118
Blank Cover Plate	118
Raceway Covers	118

Electrical Components — Hardwire / International

Top Feed Module – Hardwire / International – UniGroup Too Only	119
Top Feed Module – Hardwire / International – UniGroup Only	119

Electrical Components — International

International Power Components	120
Plastic Liner	120

Adaptable Worksurfaces — Rectangular

General Specifications	121
Rectangular	122
Rectangular Transition	124
Swell/Inverse Swell	125
Wedge/Sharp Wedge	126
Rectangular Radius End	129

Adaptable Worksurfaces — Corner

General Specifications	130
Bent	131
Merger Corner – 90°	132
Straight Front Corner – 90°	133
Wrap-Around Corner – 90° — Wrap-Around/Wrap-Around Transitional	134
Wrap-Around Extended Corner – 90° — Wrap-Around Extended/Wrap-Around Extended Transitional	135
Notched Corner – 90° — Notched/Notched Transitional	139
Notched Extended Corner – 90°	140
Angled Corner – 90° — Angled/Angled Transitional	142

Adaptable Worksurfaces — Convergent

General Specifications	143
Rectangular	144
D-Shape Convergent	145
D-Shape Ender Convergent	146
D-Shape Convergent Wrap-Around	147

Adaptable Worksurfaces

Conference End/Key Conference End	149
120° Link	150
Rectangular Key	151
Countertop	152
Adjustable Split Top — Rectangular	153
Adjustable Split Top — Corner — 90°	153

Worksurface Supports

Standard Cantilever Bracket	154
Standard Mini Cantilever Bracket	154
Standard Cantilever Link Cantilever Bracket	154
Side Bracket	155
Convergent Mount Bracket	155
Pedestal-to-Panel Bracket	156
Worksurface Support Panels	157
Anti Dislodgement Bracket	157
Straight Leg Basic	158
Double Support Leg	159
Single Support Leg	159
Support Post	159
Make-A-Corner	160

Adaptable Upper Storage

Straight Mini Shelf, Standard Mount	161
Corner Mini Shelf, Standard Mount	161
Overhead Storage Unit — Standard Mount	162
Overhead Storage Unit — Up Mount	167
Open Shelf Standard Mount	172
Shelf Divider	172
Overhead Storage Unit / Shelf Gang Clip	172

Wall Mount Components

Overhead Storage Unit — Wall Mount	173
Wall Track	178
Back for Wall Mounted Overhead Storage Unit	178
Worksurface and Gallery Panel Wall Mount Bracket	178
Tackboard, Wall Mount	179
Markerboard, Wall Mount	179
Adaptable Shelf Divider	180
Slat, Wall Mount	181

Tack Strips/Tackboards

Tack Strip	182
Tack Board	182

Markerboards/Wall Accessory Slat Pad

Markerboard — Non-Magnetic Surface	183
Wall Accessory Slat Pad	183
Markerboard Accessories	184

Belong Work Tools Mounting Rails

Tool Rail—Worksurface Mount C-Clamp or Thru-Mount	185
Tool Rail — Single Post — C-Clamp or Thru-mount	186

Lighting — Task

Reed Premiere™ Stand-Alone LED Task Light	187
Reed Premier™ Starter LED Task Light	187
Reed Premiere™ Add-On LED Task Light — For Use with Reed Premier Starter LED Task Lights	188
Reed Premier™ Add-On Occupancy Sensor	188
Adjustable LED Task Light – Stand-Alone	189
Adaptable LED Task Light – Starter Kit	189
Adaptable LED Task Light – Add-On Kit	190

Resources

Fabrics and Finishes

Finish/Color Legend	192
Fabrics/Color Legend	193

COM Yardage Requirements

UniGroup Too	194
UniGroup	196

Index

Lifetime Product Warranty

Inside Back Cover

Statement of Line

UniGroup Too Panels

Pages 18-54

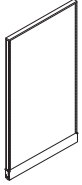

Basic Monolithic Panel — No Power



Basic Monolithic Panel — Powered



Fabric Monolithic Panel — No Power



Fabric Monolithic Panel — Powered

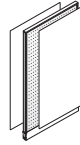

Monolithic Panel with Full-Height Inserts — No Power

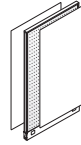

Monolithic Panel with Full-Height Inserts — Powered

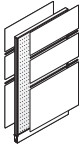

Monolithic Panel with Segmented Inserts — No Power

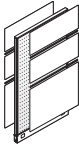

Monolithic Panel with Segmented Inserts — Powered



Monolithic Panel Core without Insert(s) — No Power



Monolithic Panel Core without Insert(s) — Powered

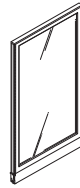

Glazed Monolithic Panel — No Power

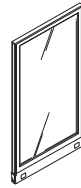

Glazed Monolithic Panel — Powered

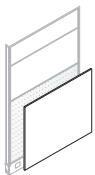

Base Insert — Fabric

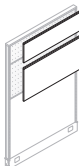

Upper Insert — Fabric or Markerboard



Fabric Add-On Panel

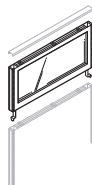

Glazed Add-On Panel



Sliding Door



Filler Post - Sliding Door

UniGroup Too Swing Door

Page 55



Single Door

Statement of Line

UniGroup Too Panel Accessories

Pages 56-64

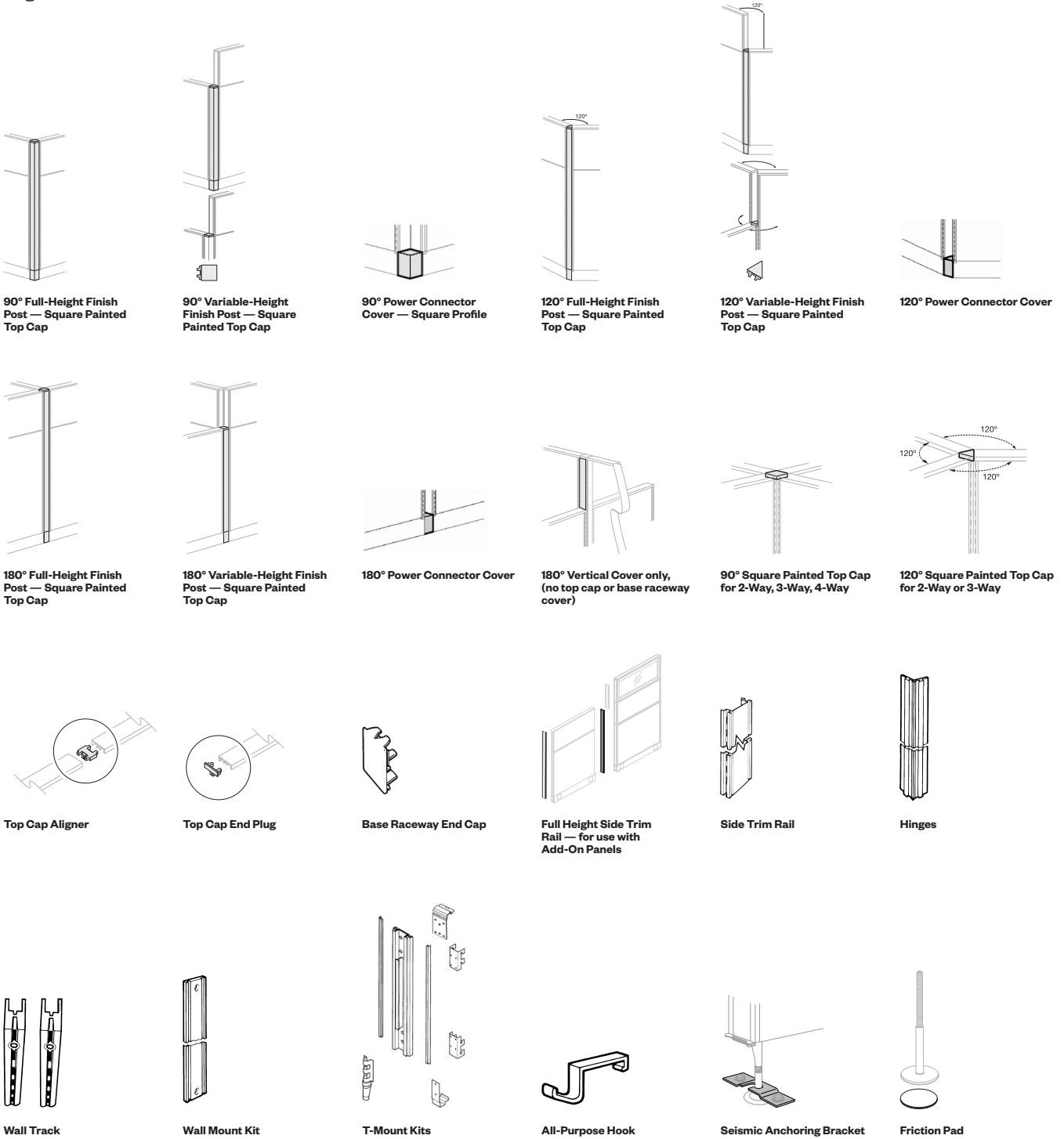

Statement of Line

UniGroup Panels

Pages 65-87

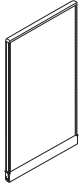

Monolithic Panel with Steel Top Cap — No Power



Monolithic Panel with Steel Top Cap — Powered

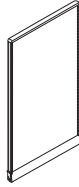

Basic Monolithic Panel with Steel Top Cap — No Power



Basic Monolithic Panel with Steel Top Cap — Powered



Open Frame Panel with Steel Top Cap — No Power



Open Frame Panel with Steel Top Cap — Powered



Glazed Monolithic Panel with Steel Top Cap — No Power



Glazed Monolithic Panel with Steel Top Cap — Powered

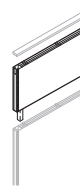

Fabric Add-On Panel

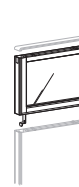

Glazed Add-On Panel

UniGroup Swing Doors with Steel Top Cap

Page 89



Single Door

UniGroup Panel Accessories

Pages 90-94

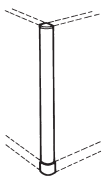

90° Finish Post — for Steel Top Cap — Painted Surface



90° Power Connector Cover



180° Power Connector Cover — Radius Profile

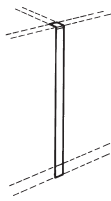

180° Finish Post — for Steel Top Cap — Painted Surface



Steel Top Cap for 3-Way and 4-Way



Full-Height Side Trim Rails — for use with Add-On Panels



Side Trim Rail

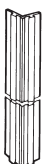

Hinges

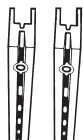

Wall Track



Wall Mount Kit

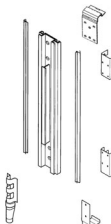

T-Mount Kit — Center and End Conditions



All-Purpose Hook

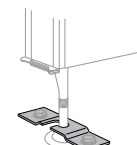

Seismic Anchoring Bracket



Friction Pad

Statement of Line

Panel Accessories — Retrofit Kits

Pages 95-100

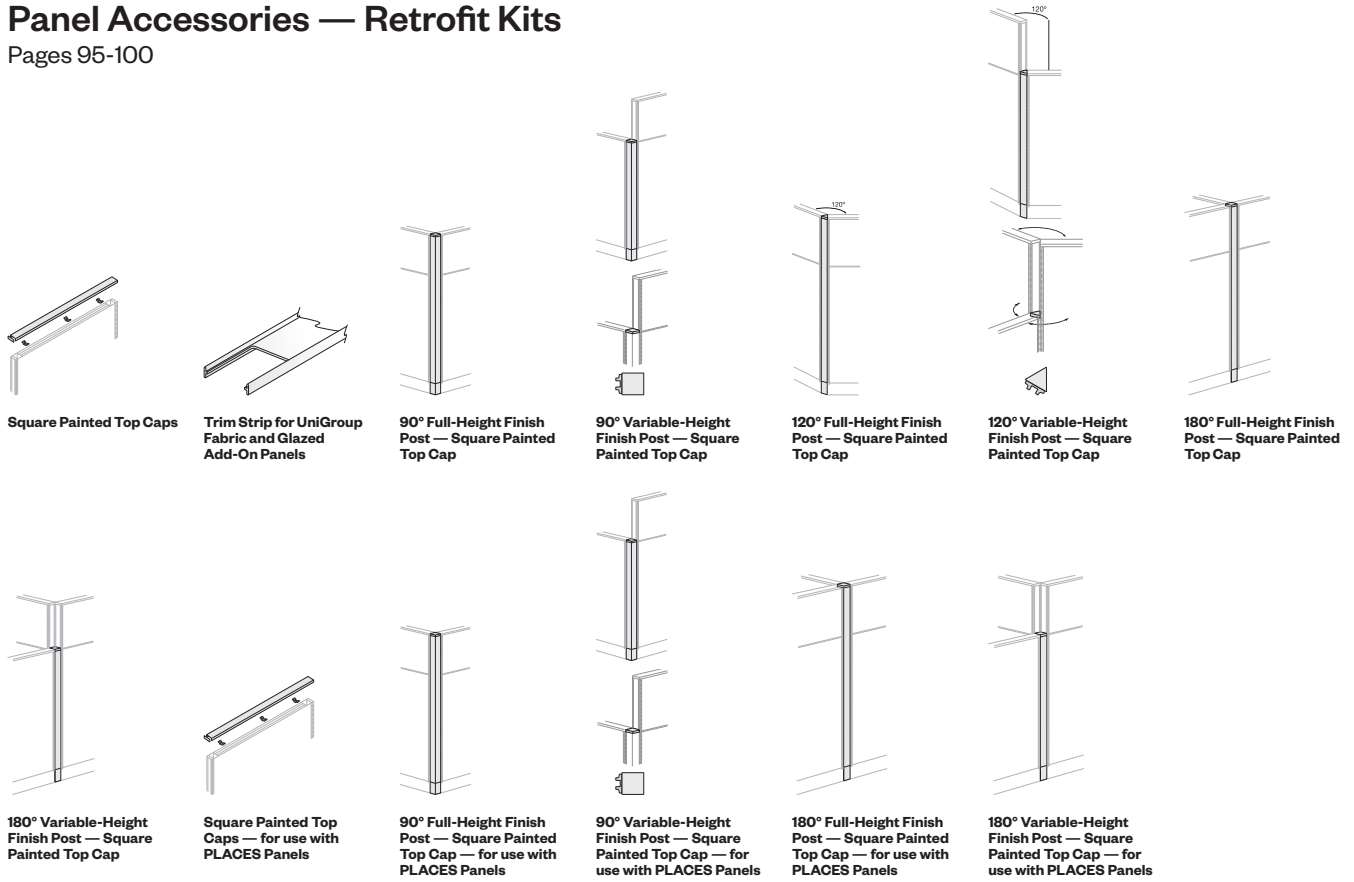

Clerestory Kits

Page 102



Electrical Components

Pages 103-114

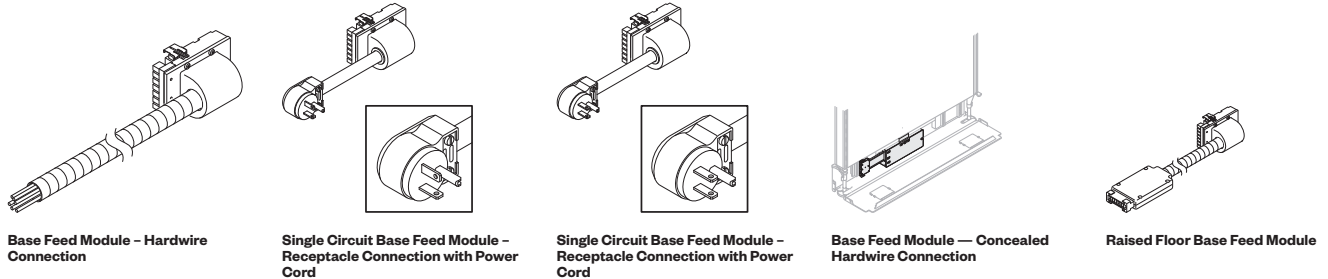

Statement of Line

Electrical Components (cont'd)

Pages 103-114

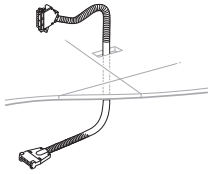

Internal Power Base AI Feed

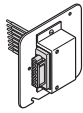

Wall Feed Field Wired 1 Port



Infeed Harness



Top Feed Module — UniGroup Too Only



Top Feed Module — UniGroup Only

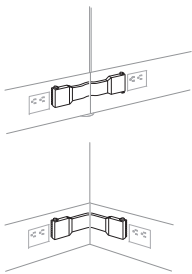

Flexible Power Connector — Panel-to-Panel

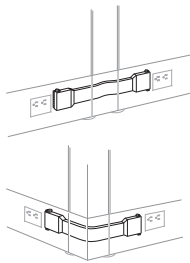

Flexible Power Connector — Straight Span

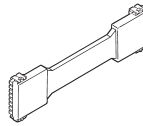

Connector Assembly — 12" Pass-Through

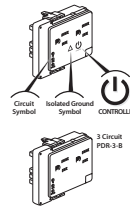

Duplex Receptacle — 15 Amp

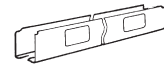
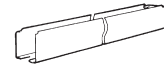

Raceway Retrofit Kit

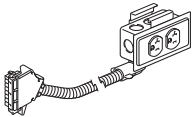

Duplex Receptacle — 20 Amp

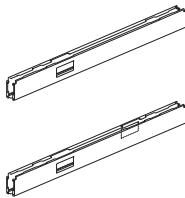

Raceway Cover — 20 Amp

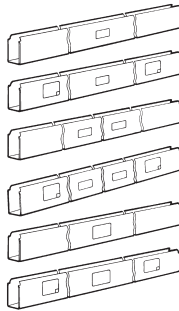

Ported Raceway Covers



Base Raceway End Cap

Electrical and Cable Management Accessories

Pages 115-116



Cable Management Pole — One Channel — UniGroup Too, UniGroup

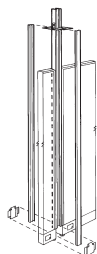

Cable Management Pole — Two Channels — UniGroup Too, UniGroup

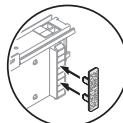

Power Breaker Marker — UniGroup Too, UniGroup

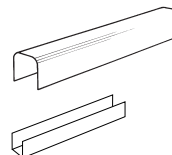

Expanded Top Cap Raceway — UniGroup Only

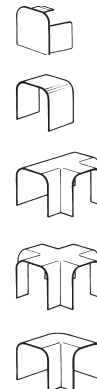

Expanded Top Finish Cap — UniGroup Only

Statement of Line

Electrical Components — Hardwire

Page 118

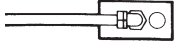

Base Feed Kit

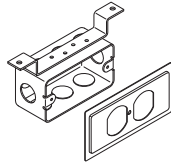
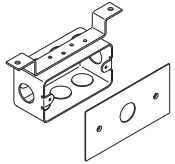

Dual Power Access Raceway Kit — 4"-High Base Raceway



Blank Cover Plate

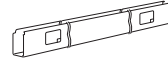

Raceway Covers

Electrical Components — Hardwire — International

Pages 119-120

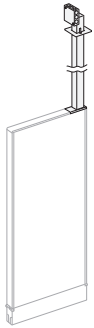

Top Feed Module — Hardwire / International — UniGroup Too Only

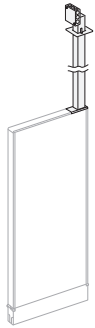

Top Feed Module — Hardwire / International — UniGroup Only



Power Entry Cord

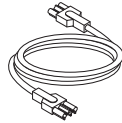

Cord

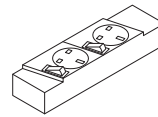

Receptacle



Splitter

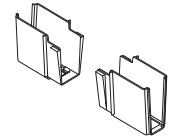

Plastic Liner

Adaptable Worksurfaces — Rectangular

Pages 122-129

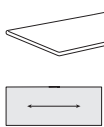

Rectangular

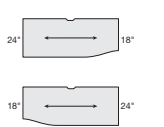

Rectangular Transition

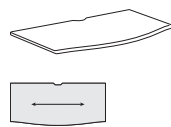

Swell

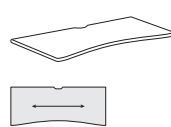

Inverse Swell

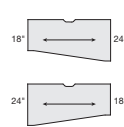

Wedge

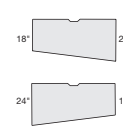

Sharp Wedge

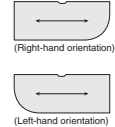

Rectangular Radius End

Statement of Line

Adaptable Worksurfaces — Corner

Pages 131-142

Bent

Merger Corner - 90°

Straight Front Corner - 90°

Wrap-Around Corner - 90°

Wrap-Around Transitional Corner - 90°

Wrap-Around Extended Corner - 90°

Wrap-Around Extended Transitional Corner - 90°

Notched Corner - 90°

Notched Transitional Corner - 90°

Notch Extended Corner - 90°

Angled Corner - 90°

Angled Transitional Corner - 90°

Adaptable Worksurfaces — Convergent

Pages 144-147

Rectangular Convergent

D-Shape Convergent

D-Shape Ender Convergent

D-Shape Convergent Wrap-Around

Statement of Line

Adaptable Worksurfaces

Pages 149-153

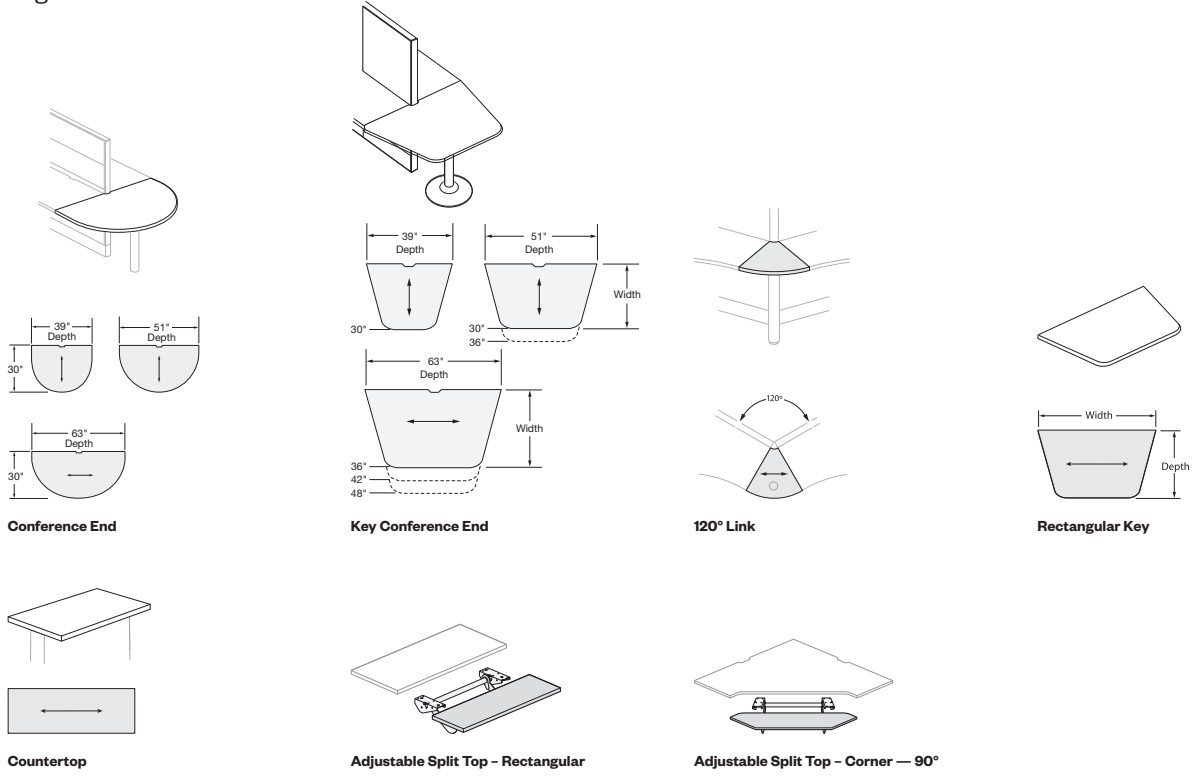

Worksurface Supports

Pages 154-160

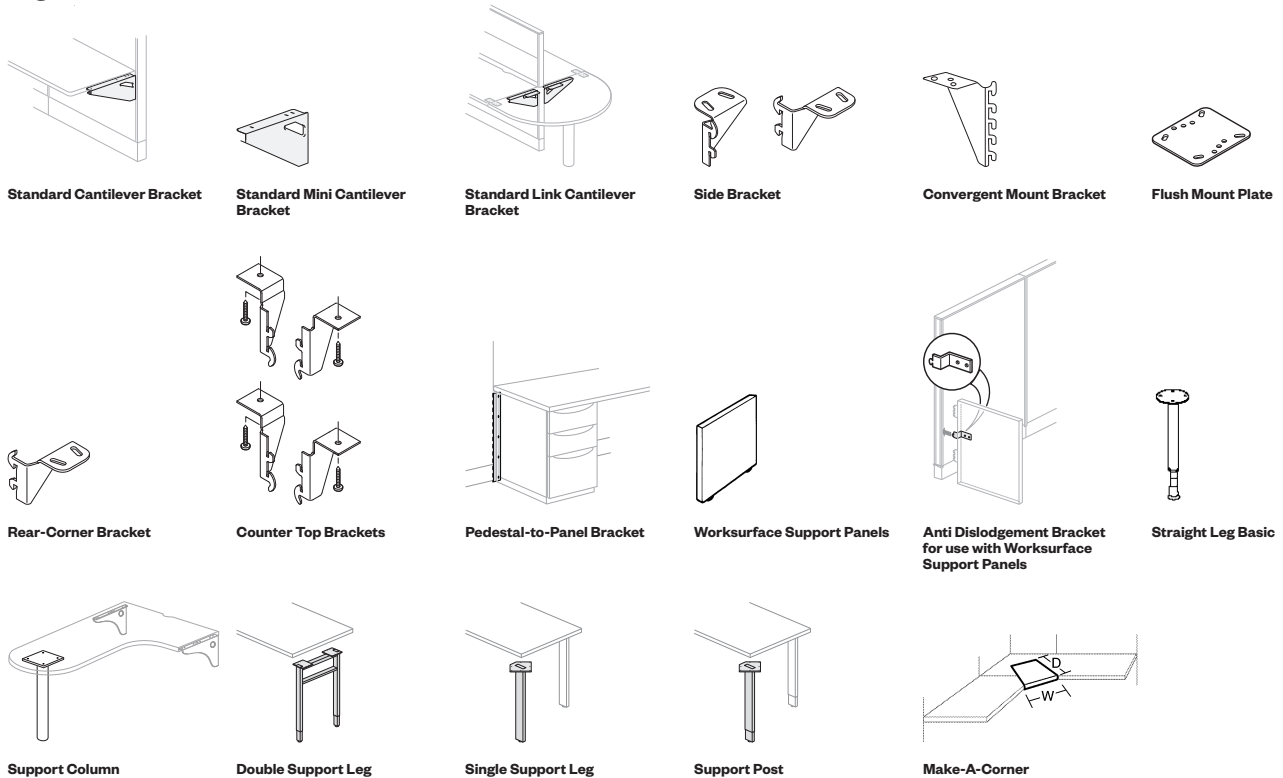

Statement of Line

Adaptable Upper Storage

Pages 161-172

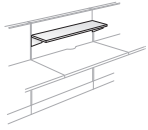

Straight Mini Shelf, Standard Mount

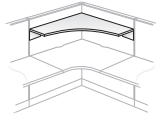

Corner Mini Shelf, Standard Mount

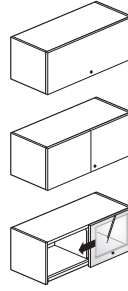

Overhead Storage Unit — Standard Mount

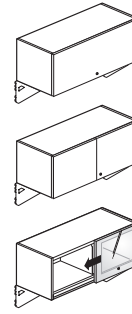

Overhead Storage Unit — Up Mount

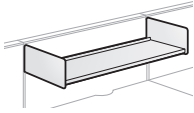

Open Shelf — Standard Mount

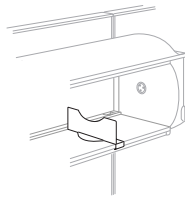

Shelf Dividers



Overhead Storage Unit / Shelf Gang Clip

Wall Mount Components

Pages 173-181

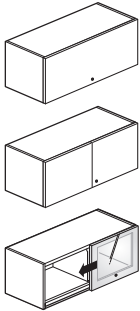

Overhead Storage Unit — Wall Mount

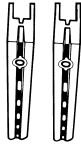

Wall Track



Back for Wall Mounted Overhead Storage Unit

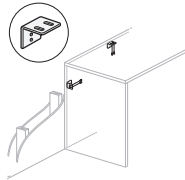

Worksurface and Gallery Panel Wall Mount Bracket



Tackboard, Wall Mount



Markerboard, Wall Mount

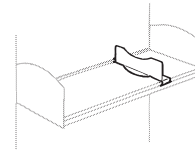

Adaptable Shelf Divider

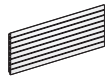

Slat, Wall Mount

Tack Strips/Tackboards

Page 182



Tack Strip



Tackboard

Markerboards/Wall Accessory Slat Pad

Pages 183-184

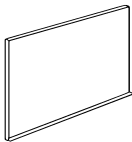

Markerboard — Non-Magnetic Surface



Wall Accessory Slat Pad



7062-8001



7031-7002



7031-7001

Statement of Line

Belong Work Tools Mounting Rails

Pages 185-186

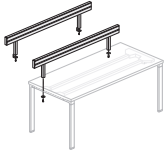

**Tool Rail — Worksurface Mount
C-Clamp or Thru-Mount**



**Tool Rail — Single Post —
C-Clamp or Thru-mount**

Lighting — Task

Pages 187-190

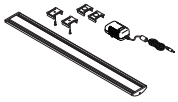

**Reed Premier™
Stand-Alone LED Task Light**

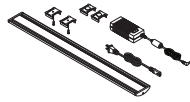

**Reed Premier™
Starter LED Task Light**



**Reed Premier™
Add-On LED Task Light — For Use with
Reed Premier Starter LED Task Lights**

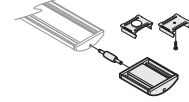

**Reed Premier™
Add-On Occupancy Sensor**



**Adaptable LED Task Light -
Stand-Alone**

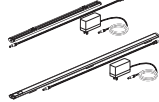

**Adaptable LED Task Light -
Starter Kit**



**Adaptable LED Task Light -
Add-On Kit**

Basic Monolithic Panel — No Power

UniGroup Too

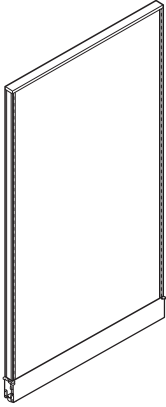

E2MN-B (Non-Powered)
Class AC

Note: This panel has fabric/colorway restrictions, see systems fabrics/ color legend.

Features

- Includes non-powered panel assembly, square top cap with aligner, with or without one-piece base raceway cover, 1.6 hinge kits, side trim rails, leveling glides and carpet gripper. .6 top cap end plugs and base raceway end caps are shipped with each panel. Order additional as necessary.
- Acoustical panel surfaces over 0.125"(3mm) thick fiber board.
- Panel surfaces may have the same fabric on both sides or a different fabric on each side.
- Panel thickness is 2"(51mm).
- Base raceway is 4"(102mm)H.
- Shipped with unassembled top cap, base raceway cover and side trim rails.

Specification Tips

- Panels will accept add-on panels up to a combined height of 80"(2032mm). For aesthetic consistency, specify UniGroup Too add-on panels.
- Raceway cover must be separately specified for option -BE (no raceway cover).
- If 90° top cap for four-way and 120° top cap for three-way are not specified, additional top cap end plugs will need to be ordered.
- Additional top cap end plugs and base raceway end caps will need to be specified if finish posts are not ordered.

To Order, Specify:

1) Product number, including:

1 Options:

B With Raceway Cover

BE Without Raceway Cover
(deduct **\$122.58** list)

- 2) Fabric/colorway for panel side one.
- 3) Fabric/colorway for panel side two.
- 4) Trim color raceway cover, glide housings and end caps. Not available in metallic trim colors.
- 5) Trim color for top cap and side trim rails.

Note: Upcharge for mixed surface grades, refer to the electronic design and specification tools for pricing.

Notes:

- Non-powered panels ship without receptacle ports in the base raceway cover.
- Some building codes may restrict the use of panel heights greater than 69"(1753mm). Consult your local code authority to assure that the furniture layout is compliant.
- For International Power, specify non-powered panels and use Power Logic components. See Specification Guide for more information on Power Logic.
- For Chicago power, specify non-powered panels without a base raceway cover and separately specify Chicago power retrofit kit.

Basic Monolithic Panel — No Power

UniGroup Too

Actual Height	Width	Number ①	Trim A Fabric					
			A	B	C	E	F	G
32"(813mm)	24"(610mm)	E2MN-230-■ ■	\$1006.33	\$ 1122.49	\$ 1250.33	\$ 1529.19	\$ 1715.07	\$ 1831.17
	30"(762mm)	E2MN-3030-■ ■ ■	1064.11	1183.87	1318.91	1619.37	1819.65	1939.35
	36"(914mm)	E2MN-330-■ ■	1121.89	1245.25	1387.49	1709.55	1924.23	2047.53
	42"(1067mm)	E2MN-4230-■ ■ ■	1179.67	1306.63	1456.07	1799.73	2028.81	2155.71
	48"(1219mm)	E2MN-430-■ ■	1237.45	1368.01	1524.65	1889.91	2133.39	2263.89
	60"(1524mm)	E2MN-530-■ ■ ■	1353.01	1490.77	1661.81	2070.27	2342.55	2480.25
40"(1016mm)	24"(610mm)	E2MN-238-■ ■	\$1079.61	\$ 1199.61	\$ 1335.13	\$ 1637.03	\$ 1838.27	\$ 1958.21
	30"(762mm)	E2MN-3038-■ ■ ■	1150.83	1275.39	1420.03	1749.29	1968.77	2093.27
	36"(914mm)	E2MN-338-■ ■	1222.05	1351.17	1504.93	1861.55	2099.27	2228.33
	42"(1067mm)	E2MN-4238-■ ■ ■	1293.27	1426.95	1589.83	1973.81	2229.77	2363.39
	48"(1219mm)	E2MN-438-■ ■	1364.49	1502.73	1674.73	2086.07	2360.27	2498.45
	60"(1524mm)	E2MN-538-■ ■ ■	1506.93	1654.29	1844.53	2310.59	2621.27	2768.57
48"(1219mm)	24"(610mm)	E2MN-246-■ ■	\$ 1152.89	\$ 1276.73	\$ 1419.93	\$ 1744.87	\$ 1961.47	\$2085.25
	30"(762mm)	E2MN-3046-■ ■ ■	1237.55	1366.91	1521.15	1879.21	2117.89	2247.19
	36"(914mm)	E2MN-346-■ ■	1322.21	1457.09	1622.37	2013.55	2274.31	2409.13
	42"(1067mm)	E2MN-4246-■ ■ ■	1406.87	1547.27	1723.59	2147.89	2430.73	2571.07
	48"(1219mm)	E2MN-446-■ ■	1491.53	1637.45	1824.81	2282.23	2587.15	2733.01
	60"(1524mm)	E2MN-546-■ ■ ■	1660.85	1817.81	2027.25	2550.91	2899.99	3056.89
56"(1422mm)	24"(610mm)	E2MN-254-■ ■	\$ 1226.17	\$ 1353.85	\$ 1504.73	\$ 1852.71	\$2084.67	\$ 2212.29
	30"(762mm)	E2MN-3054-■ ■ ■	1324.27	1458.43	1622.27	2009.13	2267.01	2401.11
	36"(914mm)	E2MN-354-■ ■	1422.37	1563.01	1739.81	2165.55	2449.35	2589.93
	42"(1067mm)	E2MN-4254-■ ■ ■	1520.47	1667.59	1857.35	2321.97	2631.69	2778.75
	48"(1219mm)	E2MN-454-■ ■	1618.57	1772.17	1974.89	2478.39	2814.03	2967.57
	60"(1524mm)	E2MN-554-■ ■ ■	1814.77	1981.33	2209.97	2791.23	3178.71	3345.21
64"(1626mm)	24"(610mm)	E2MN-262-■ ■	\$ 1299.45	\$ 1430.97	\$ 1589.53	\$ 1960.55	\$ 2207.87	\$2339.33
	30"(762mm)	E2MN-3062-■ ■ ■	1410.99	1549.95	1723.39	2139.05	2416.13	2555.03
	36"(914mm)	E2MN-362-■ ■	1522.53	1668.93	1857.25	2317.55	2624.39	2770.73
	42"(1067mm)	E2MN-4262-■ ■ ■	1634.07	1787.91	1991.11	2496.05	2832.65	2986.43
	48"(1219mm)	E2MN-462-■ ■	1745.61	1906.89	2124.97	2674.55	3040.91	3202.13
	60"(1524mm)	E2MN-562-■ ■ ■	1968.69	2144.85	2392.69	3031.55	3457.43	3633.53
72"(1829mm)	24"(610mm)	E2MN-270-■ ■	\$ 1372.73	\$ 1508.09	\$ 1674.33	\$2068.39	\$ 2331.07	\$2466.37
	30"(762mm)	E2MN-3070-■ ■ ■	1497.71	1641.47	1824.51	2268.97	2565.25	2708.95
	36"(914mm)	E2MN-370-■ ■	1622.69	1774.85	1974.69	2469.55	2799.43	2951.53
	42"(1067mm)	E2MN-4270-■ ■ ■	1747.67	1908.23	2124.87	2670.13	3033.61	3194.11
	48"(1219mm)	E2MN-470-■ ■	1872.65	2041.61	2275.05	2870.71	3267.79	3436.69
	60"(1524mm)	E2MN-570-■ ■ ■	2122.61	2308.37	2575.41	3271.87	3736.15	3921.85
80"(2032mm)	24"(610mm)	E2MN-278-■ ■	\$1446.01	\$ 1585.21	\$ 1759.13	\$ 2176.23	\$2454.27	\$2593.41
	30"(762mm)	E2MN-3078-■ ■ ■	1584.43	1732.99	1925.63	2398.89	2714.37	2862.87
	36"(914mm)	E2MN-378-■ ■	1722.85	1880.77	2092.13	2621.55	2974.47	3132.33
	42"(1067mm)	E2MN-4278-■ ■ ■	1861.27	2028.55	2258.63	2844.21	3234.57	3401.79
	48"(1219mm)	E2MN-478-■ ■	1999.69	2176.33	2425.13	3066.87	3494.67	3671.25
	60"(1524mm)	E2MN-578-■ ■ ■	2276.53	2471.89	2758.13	3512.19	4014.87	4210.17

Basic Monolithic Panel — No Power

UniGroup Too

Actual Height	Width	Number ①	Trim B Fabric					
			A	B	C	E	F	G
32"(813mm)	24"(610mm)	E2MN-230-■ ■	\$ 1022.76	\$ 1138.92	\$ 1266.76	\$ 1545.62	\$ 1731.50	\$ 1847.60
	30"(762mm)	E2MN-3030-■ ■	1081.62	1201.38	1336.42	1636.88	1837.16	1956.86
	36"(914mm)	E2MN-330-■ ■	1140.48	1263.84	1406.08	1728.14	1942.82	2066.12
	42"(1067mm)	E2MN-4230-■ ■	1199.34	1326.30	1475.74	1819.40	2048.48	2175.38
	48"(1219mm)	E2MN-430-■ ■	1258.20	1388.76	1545.40	1910.66	2154.14	2284.64
	60"(1524mm)	E2MN-530-■ ■	1375.92	1513.68	1684.72	2093.18	2365.46	2503.16
40"(1016mm)	24"(610mm)	E2MN-238-■ ■	\$ 1097.16	\$ 1217.16	\$ 1352.68	\$ 1654.58	\$ 1855.82	\$ 1975.76
	30"(762mm)	E2MN-3038-■ ■	1169.46	1294.02	1438.66	1767.92	1987.40	2111.90
	36"(914mm)	E2MN-338-■ ■	1241.76	1370.88	1524.64	1881.26	2118.98	2248.04
	42"(1067mm)	E2MN-4238-■ ■	1314.06	1447.74	1610.62	1994.60	2250.56	2384.18
	48"(1219mm)	E2MN-438-■ ■	1386.36	1524.60	1696.60	2107.94	2382.14	2520.32
	60"(1524mm)	E2MN-538-■ ■	1530.96	1678.32	1868.56	2334.62	2645.30	2792.60
48"(1219mm)	24"(610mm)	E2MN-246-■ ■	\$ 1171.56	\$ 1295.40	\$ 1438.60	\$ 1763.54	\$ 1980.14	\$ 2103.92
	30"(762mm)	E2MN-3046-■ ■	1257.30	1386.66	1540.90	1898.96	2137.64	2266.94
	36"(914mm)	E2MN-346-■ ■	1343.04	1477.92	1643.20	2034.38	2295.14	2429.96
	42"(1067mm)	E2MN-4246-■ ■	1428.78	1569.18	1745.50	2169.80	2452.64	2592.98
	48"(1219mm)	E2MN-446-■ ■	1514.52	1660.44	1847.80	2305.22	2610.14	2756.00
	60"(1524mm)	E2MN-546-■ ■	1686.00	1842.96	2052.40	2576.06	2925.14	3082.04
56"(1422mm)	24"(610mm)	E2MN-254-■ ■	\$ 1245.96	\$ 1373.64	\$ 1524.52	\$ 1872.50	\$ 2104.46	\$ 2232.08
	30"(762mm)	E2MN-3054-■ ■	1345.14	1479.30	1643.14	2030.00	2287.88	2421.98
	36"(914mm)	E2MN-354-■ ■	1444.32	1584.96	1761.76	2187.50	2471.30	2611.88
	42"(1067mm)	E2MN-4254-■ ■	1543.50	1690.62	1880.38	2345.00	2654.72	2801.78
	48"(1219mm)	E2MN-454-■ ■	1642.68	1796.28	1999.00	2502.50	2838.14	2991.68
	60"(1524mm)	E2MN-554-■ ■	1841.04	2007.60	2236.24	2817.50	3204.98	3371.48
64"(1626mm)	24"(610mm)	E2MN-262-■ ■	\$ 1320.36	\$ 1451.88	\$ 1610.44	\$ 1981.46	\$ 2228.78	\$ 2360.24
	30"(762mm)	E2MN-3062-■ ■	1432.98	1571.94	1745.38	2161.04	2438.12	2577.02
	36"(914mm)	E2MN-362-■ ■	1545.60	1692.00	1880.32	2340.62	2647.46	2793.80
	42"(1067mm)	E2MN-4262-■ ■	1658.22	1812.06	2015.26	2520.20	2856.80	3010.58
	48"(1219mm)	E2MN-462-■ ■	1770.84	1932.12	2150.20	2699.78	3066.14	3227.36
	60"(1524mm)	E2MN-562-■ ■	1996.08	2172.24	2420.08	3058.94	3484.82	3660.92
72"(1829mm)	24"(610mm)	E2MN-270-■ ■	\$ 1394.76	\$ 1530.12	\$ 1696.36	\$ 2090.42	\$ 2353.10	\$ 2488.40
	30"(762mm)	E2MN-3070-■ ■	1520.82	1664.58	1847.62	2292.08	2588.36	2732.06
	36"(914mm)	E2MN-370-■ ■	1646.88	1799.04	1998.88	2493.74	2823.62	2975.72
	42"(1067mm)	E2MN-4270-■ ■	1772.94	1933.50	2150.14	2695.40	3058.88	3219.38
	48"(1219mm)	E2MN-470-■ ■	1899.00	2067.96	2301.40	2897.06	3294.14	3463.04
	60"(1524mm)	E2MN-570-■ ■	2151.12	2336.88	2603.92	3300.38	3764.66	3950.36
80"(2032mm)	24"(610mm)	E2MN-278-■ ■	\$ 1469.16	\$ 1608.36	\$ 1782.28	\$ 2199.38	\$ 2477.42	\$ 2616.56
	30"(762mm)	E2MN-3078-■ ■	1608.66	1757.22	1949.86	2423.12	2738.60	2887.10
	36"(914mm)	E2MN-378-■ ■	1748.16	1906.08	2117.44	2646.86	2999.78	3157.64
	42"(1067mm)	E2MN-4278-■ ■	1887.66	2054.94	2285.02	2870.60	3260.96	3428.18
	48"(1219mm)	E2MN-478-■ ■	2027.16	2203.80	2452.60	3094.34	3522.14	3698.72
	60"(1524mm)	E2MN-578-■ ■	2306.16	2501.52	2787.76	3541.82	4044.50	4239.80

Basic Monolithic Panel — Powered

UniGroup Too

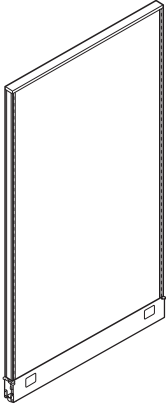

E2MP-B (3-circuit)
Class AC



Note: This panel has fabric/colorway restrictions, see systems fabrics/ color legend.

Features

- Includes powered panel assembly, square top cap with aligner, with or without one-piece base raceway cover, 1.6 hinge kits, side trim rails, leveling glides and carpet gripper; power distribution assembly/flex connector(s). **.6** top cap end plugs and base raceway end caps are shipped with each panel. Order additional as necessary.
- Acoustical fabric surface over 0.125”(3mm) thick fiber board.
- Panel surfaces may have the same fabric on both sides or a different fabric on each side.
- Panel thickness is 2”(51mm).
- Base raceway is 4”(102mm)H.
- Powered raceway with or without raceway cover requires modified catalog number and list price.
- Powered panels are available for countries that utilize 120 volt 60 hertz electrical systems and U.S. configured plugs and outlets.
- Shipped with unassembled top cap, base raceway cover and side trim rails.

Specification Tips

- Panels will accept add-on panels up to a combined height of 80”(2032mm). For aesthetic consistency, specify UniGroup Too add-on panels.
- Flex connectors provided for powered monolithic panels accommodate straight in-line, inside 90°, and inside 120° conditions (if applicable).
- Receptacles for powered panels must be specified separately.
- Raceway cover must be separately specified for option -BE or BYE (no raceway cover).
- If 90° top cap for four-way and 120° top cap for three-way are not specified, additional top cap end plugs will need to be ordered.
- Additional top cap end plugs and base raceway end caps will need to be specified if finish posts are not ordered.

To Order, Specify:

1) Product number, including:

1 3-Circuit

B With Raceway Cover

BE Without Raceway Cover
(deduct **\$138.36** list)

BY NYC with Raceway Cover

BYE NYC without Raceway Cover
(deduct **\$138.36** list)

- 2) Fabric/colorway for panel side one.
- 3) Fabric/colorway for panel side two.
- 4) Trim color raceway cover, glide housings and end caps. Not available in metallic trim colors.
- 5) Trim color for top cap and side trim rails.

Note: Upcharge for mixed surface grades, refer to the electronic design and specification tools for pricing.

Notes:

- Powered panels with raceway covers ship with receptacle ports in the base raceway cover. Receptacle ports on the raceway cover measure 2.35”(60mm) top-to-bottom and 2.88”(73mm) side-to-side.
- Powered panels with Power Distribution Assemblies (PDA) but without raceway covers require separately specified base raceway covers for power and communication port locations other than the standard powered base raceway cover.
- New York City (NYC) electrical applications require field installation of PDA.
- New York Port Authority (NYPA) electrical applications require metal raceway covers. To order, specify NYC powered panels without raceway cover and separately specify metal covers through Haworth e-Parts.
- Some building codes may restrict the use of panel heights greater than 69”(1753mm). Consult your local code authority to assure that the furniture layout is compliant.
- For International Power, specify non-powered panels and use Power Logic components. See Specification Guide for more information on Power Logic.
- For Chicago power, specify non-powered panels without a base raceway cover and separately specify Chicago power retrofit kit.

Basic Monolithic Panel — Powered

UniGroup Too

Actual Height	Width	Number ①	Trim A Fabric					
			A	B	C	E	F	G
32"(813mm)	24"(610mm)	E2MP-230-■ ■	\$ 1457.37	\$ 1573.53	\$ 1701.37	\$ 1980.23	\$ 2166.11	\$ 2282.21
	30"(762mm)	E2MP-3030-■ ■	1515.15	1634.91	1769.95	2070.41	2270.69	2390.39
	36"(914mm)	E2MP-330-■ ■	1572.93	1696.29	1838.53	2160.59	2375.27	2498.57
	42"(1067mm)	E2MP-4230-■ ■	1630.71	1757.67	1907.11	2250.77	2479.85	2606.75
	48"(1219mm)	E2MP-430-■ ■	1688.49	1819.05	1975.69	2340.95	2584.43	2714.93
	60"(1524mm)	E2MP-530-■ ■	1804.05	1941.81	2112.85	2521.31	2793.59	2931.29
40"(1016mm)	24"(610mm)	E2MP-238-■ ■	\$ 1530.65	\$ 1650.65	\$ 1786.17	\$ 2088.07	\$ 2289.31	\$ 2409.25
	30"(762mm)	E2MP-3038-■ ■	1601.87	1726.43	1871.07	2200.33	2419.81	2544.31
	36"(914mm)	E2MP-338-■ ■	1673.09	1802.21	1955.97	2312.59	2550.31	2679.37
	42"(1067mm)	E2MP-4238-■ ■	1744.31	1877.99	2040.87	2424.85	2680.81	2814.43
	48"(1219mm)	E2MP-438-■ ■	1815.53	1953.77	2125.77	2537.11	2811.31	2949.49
	60"(1524mm)	E2MP-538-■ ■	1957.97	2105.33	2295.57	2761.63	3072.31	3219.61
48"(1219mm)	24"(610mm)	E2MP-246-■ ■	\$ 1603.93	\$ 1727.77	\$ 1870.97	\$ 2195.91	\$ 2412.51	\$ 2536.29
	30"(762mm)	E2MP-3046-■ ■	1688.59	1817.95	1972.19	2330.25	2568.93	2698.23
	36"(914mm)	E2MP-346-■ ■	1773.25	1908.13	2073.41	2464.59	2725.35	2860.17
	42"(1067mm)	E2MP-4246-■ ■	1857.91	1998.31	2174.63	2598.93	2881.77	3022.11
	48"(1219mm)	E2MP-446-■ ■	1942.57	2088.49	2275.85	2733.27	3038.19	3184.05
	60"(1524mm)	E2MP-546-■ ■	2111.89	2268.85	2478.29	3001.95	3351.03	3507.93
56"(1422mm)	24"(610mm)	E2MP-254-■ ■	\$ 1677.21	\$ 1804.89	\$ 1955.77	\$ 2303.75	\$ 2535.71	\$ 2663.33
	30"(762mm)	E2MP-3054-■ ■	1775.31	1909.47	2073.31	2460.17	2718.05	2852.15
	36"(914mm)	E2MP-354-■ ■	1873.41	2014.05	2190.85	2616.59	2900.39	3040.97
	42"(1067mm)	E2MP-4254-■ ■	1971.51	2118.63	2308.39	2773.01	3082.73	3229.79
	48"(1219mm)	E2MP-454-■ ■	2069.61	2223.21	2425.93	2929.43	3265.07	3418.61
	60"(1524mm)	E2MP-554-■ ■	2265.81	2432.37	2661.01	3242.27	3629.75	3796.25
64"(1626mm)	24"(610mm)	E2MP-262-■ ■	\$ 1750.49	\$ 1882.01	\$ 2040.57	\$ 2411.59	\$ 2658.91	\$ 2790.37
	30"(762mm)	E2MP-3062-■ ■	1862.03	2000.99	2174.43	2590.09	2867.17	3006.07
	36"(914mm)	E2MP-362-■ ■	1973.57	2119.97	2308.29	2768.59	3075.43	3221.77
	42"(1067mm)	E2MP-4262-■ ■	2085.11	2238.95	2442.15	2947.09	3283.69	3437.47
	48"(1219mm)	E2MP-462-■ ■	2196.65	2357.93	2576.01	3125.59	3491.95	3653.17
	60"(1524mm)	E2MP-562-■ ■	2419.73	2595.89	2843.73	3482.59	3908.47	4084.57
72"(1829mm)	24"(610mm)	E2MP-270-■ ■	\$ 1823.77	\$ 1959.13	\$ 2125.37	\$ 2519.43	\$ 2782.11	\$ 2917.41
	30"(762mm)	E2MP-3070-■ ■	1948.75	2092.51	2275.55	2720.01	3016.29	3159.99
	36"(914mm)	E2MP-370-■ ■	2073.73	2225.89	2425.73	2920.59	3250.47	3402.57
	42"(1067mm)	E2MP-4270-■ ■	2198.71	2359.27	2575.91	3121.17	3484.65	3645.15
	48"(1219mm)	E2MP-470-■ ■	2323.69	2492.65	2726.09	3321.75	3718.83	3887.73
	60"(1524mm)	E2MP-570-■ ■	2573.65	2759.41	3026.45	3722.91	4187.19	4372.89
80"(2032mm)	24"(610mm)	E2MP-278-■ ■	\$ 1897.05	\$ 2036.25	\$ 2210.17	\$ 2627.27	\$ 2905.31	\$ 3044.45
	30"(762mm)	E2MP-3078-■ ■	2035.47	2184.03	2376.67	2849.93	3165.41	3313.91
	36"(914mm)	E2MP-378-■ ■	2173.89	2331.81	2543.17	3072.59	3425.51	3583.37
	42"(1067mm)	E2MP-4278-■ ■	2312.31	2479.59	2709.67	3295.25	3685.61	3852.83
	48"(1219mm)	E2MP-478-■ ■	2450.73	2627.37	2876.17	3517.91	3945.71	4122.29
	60"(1524mm)	E2MP-578-■ ■	2727.57	2922.93	3209.17	3963.23	4465.91	4661.21

Basic Monolithic Panel — Powered

UniGroup Too

Actual Height	Width	Number ①	Trim B Fabric					
			A	B	C	E	F	G
32"(813mm)	24"(610mm)	E2MP-230-■ ■	\$ 1473.80	\$ 1589.96	\$ 1717.80	\$ 1996.66	\$ 2182.54	\$ 2298.64
	30"(762mm)	E2MP-3030-■ ■	1532.66	1652.42	1787.46	2087.92	2288.20	2407.90
	36"(914mm)	E2MP-330-■ ■	1591.52	1714.88	1857.12	2179.18	2393.86	2517.16
	42"(1067mm)	E2MP-4230-■ ■	1650.38	1777.34	1926.78	2270.44	2499.52	2626.42
	48"(1219mm)	E2MP-430-■ ■	1709.24	1839.80	1996.44	2361.70	2605.18	2735.68
	60"(1524mm)	E2MP-530-■ ■	1826.96	1964.72	2135.76	2544.22	2816.50	2954.20
40"(1016mm)	24"(610mm)	E2MP-238-■ ■	\$ 1548.20	\$ 1668.20	\$ 1803.72	\$ 2105.62	\$ 2306.86	\$ 2426.80
	30"(762mm)	E2MP-3038-■ ■	1620.50	1745.06	1889.70	2218.96	2438.44	2562.94
	36"(914mm)	E2MP-338-■ ■	1692.80	1821.92	1975.68	2332.30	2570.02	2699.08
	42"(1067mm)	E2MP-4238-■ ■	1765.10	1898.78	2061.66	2445.64	2701.60	2835.22
	48"(1219mm)	E2MP-438-■ ■	1837.40	1975.64	2147.64	2558.98	2833.18	2971.36
	60"(1524mm)	E2MP-538-■ ■	1982.00	2129.36	2319.60	2785.66	3096.34	3243.64
48"(1219mm)	24"(610mm)	E2MP-246-■ ■	\$ 1622.60	\$ 1746.44	\$ 1889.64	\$ 2214.58	\$ 2431.18	\$ 2554.96
	30"(762mm)	E2MP-3046-■ ■	1708.34	1837.70	1991.94	2350.00	2588.68	2717.98
	36"(914mm)	E2MP-346-■ ■	1794.08	1928.96	2094.24	2485.42	2746.18	2881.00
	42"(1067mm)	E2MP-4246-■ ■	1879.82	2020.22	2196.54	2620.84	2903.68	3044.02
	48"(1219mm)	E2MP-446-■ ■	1965.56	2111.48	2298.84	2756.26	3061.18	3207.04
	60"(1524mm)	E2MP-546-■ ■	2137.04	2294.00	2503.44	3027.10	3376.18	3533.08
56"(1422mm)	24"(610mm)	E2MP-254-■ ■	\$ 1697.00	\$ 1824.68	\$ 1975.56	\$ 2323.54	\$ 2555.50	\$ 2683.12
	30"(762mm)	E2MP-3054-■ ■	1796.18	1930.34	2094.18	2481.04	2738.92	2873.02
	36"(914mm)	E2MP-354-■ ■	1895.36	2036.00	2212.80	2638.54	2922.34	3062.92
	42"(1067mm)	E2MP-4254-■ ■	1994.54	2141.66	2331.42	2796.04	3105.76	3252.82
	48"(1219mm)	E2MP-454-■ ■	2093.72	2247.32	2450.04	2953.54	3289.18	3442.72
	60"(1524mm)	E2MP-554-■ ■	2292.08	2458.64	2687.28	3268.54	3656.02	3822.52
64"(1626mm)	24"(610mm)	E2MP-262-■ ■	\$ 1771.40	\$ 1902.92	\$ 2061.48	\$ 2432.50	\$ 2679.82	\$ 2811.28
	30"(762mm)	E2MP-3062-■ ■	1884.02	2022.98	2196.42	2612.08	2889.16	3028.06
	36"(914mm)	E2MP-362-■ ■	1996.64	2143.04	2331.36	2791.66	3098.50	3244.84
	42"(1067mm)	E2MP-4262-■ ■	2109.26	2263.10	2466.30	2971.24	3307.84	3461.62
	48"(1219mm)	E2MP-462-■ ■	2221.88	2383.16	2601.24	3150.82	3517.18	3678.40
	60"(1524mm)	E2MP-562-■ ■	2447.12	2623.28	2871.12	3509.98	3935.86	4111.96
72"(1829mm)	24"(610mm)	E2MP-270-■ ■	\$ 1845.80	\$ 1981.16	\$ 2147.40	\$ 2541.46	\$ 2804.14	\$ 2939.44
	30"(762mm)	E2MP-3070-■ ■	1971.86	2115.62	2298.66	2743.12	3039.40	3183.10
	36"(914mm)	E2MP-370-■ ■	2097.92	2250.08	2449.92	2944.78	3274.66	3426.76
	42"(1067mm)	E2MP-4270-■ ■	2223.98	2384.54	2601.18	3146.44	3509.92	3670.42
	48"(1219mm)	E2MP-470-■ ■	2350.04	2519.00	2752.44	3348.10	3745.18	3914.08
	60"(1524mm)	E2MP-570-■ ■	2602.16	2787.92	3054.96	3751.42	4215.70	4401.40
80"(2032mm)	24"(610mm)	E2MP-278-■ ■	\$ 1920.20	\$ 2059.40	\$ 2233.32	\$ 2650.42	\$ 2928.46	\$ 3067.60
	30"(762mm)	E2MP-3078-■ ■	2059.70	2208.26	2400.90	2874.16	3189.64	3338.14
	36"(914mm)	E2MP-378-■ ■	2199.20	2357.12	2568.48	3097.90	3450.82	3608.68
	42"(1067mm)	E2MP-4278-■ ■	2338.70	2505.98	2736.06	3321.64	3712.00	3879.22
	48"(1219mm)	E2MP-478-■ ■	2478.20	2654.84	2903.64	3545.38	3973.18	4149.76
	60"(1524mm)	E2MP-578-■ ■	2757.20	2952.56	3238.80	3992.86	4495.54	4690.84

Fabric Monolithic Panel — No Power

UniGroup Too

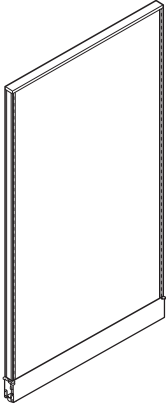

E2FN-B (Non-Powered)
Class AC

Note: This panel has fabric/colorway restrictions, see systems fabrics/ color legend.

Features

- Includes non-powered panel assembly, square top cap with aligner, with or without one-piece base raceway cover, 1.6 hinge kits, side trim rails, leveling glides and carpet gripper. .6 top cap end plugs and base raceway end caps are shipped with each panel. Order additional as necessary.
- High acoustical panel surfaces over 0.5" (13mm) thick fiber board.
- Panel surfaces may have the same fabric on both sides or a different fabric on each side.
- Panel thickness is 2" (51mm).
- Base raceway is 4" (102mm)H.
- Shipped with unassembled top cap, base raceway cover and side trim rails.

Specification Tips

- Panels will accept add-on panels up to a combined height of 80" (2032mm). For aesthetic consistency, specify UniGroup Too add-on panels.
- Raceway cover must be separately specified for option -BE (no raceway cover).
- If 90° top cap for four-way and 120° top cap for three-way are not specified, additional top cap end plugs will need to be ordered.
- Additional top cap end plugs and base raceway end caps will need to be specified if finish posts are not ordered.

To Order, Specify:

1) Product number, including:

1 Options:

B With Raceway Cover

BE Without Raceway Cover
(deduct **\$122.58** list)

- 2) Fabric/colorway for panel side one.
- 3) Fabric/colorway for panel side two.
- 4) Trim color raceway cover, glide housings and end caps. Not available in metallic trim colors.
- 5) Trim color for top cap and side trim rails.

Note: Upcharge for mixed surface grades, refer to the electronic design and specification tools for pricing.

Notes:

- Non-powered panels ship without receptacle ports in the base raceway cover.
- Some building codes may restrict the use of panel heights greater than 69" (1753mm). Consult your local code authority to assure that the furniture layout is compliant.
- For International Power, specify non-powered panels and use Power Logic components. See Specification Guide for more information on Power Logic.
- For Chicago power, specify non-powered panels without a base raceway cover and separately specify Chicago power retrofit kit.

Fabric Monolithic Panel — No Power

UniGroup Too

Actual Height	Width	Number ①	Trim A Fabric					
			A	B	C	E	F	G
32"(813mm)	24"(610mm)	E2FN-230-■ ■	\$ 1123.45	\$ 1239.61	\$ 1367.45	\$ 1646.31	\$ 1832.19	\$ 1948.29
	30"(762mm)	E2FN-3030-■ ■	1185.91	1305.67	1440.71	1741.17	1941.45	2061.15
	36"(914mm)	E2FN-330-■ ■	1246.03	1369.39	1511.63	1833.69	2048.37	2171.67
	42"(1067mm)	E2FN-4230-■ ■	1306.15	1433.11	1582.55	1926.21	2155.29	2282.19
	48"(1219mm)	E2FN-430-■ ■	1366.27	1496.83	1653.47	2018.73	2262.21	2392.71
	60"(1524mm)	E2FN-530-■ ■	1488.85	1626.61	1797.65	2206.11	2478.39	2616.09
40"(1016mm)	24"(610mm)	E2FN-238-■ ■	\$ 1201.41	\$ 1321.41	\$ 1456.93	\$ 1758.83	\$ 1960.07	\$ 2080.01
	30"(762mm)	E2FN-3038-■ ■	1274.97	1399.53	1544.17	1873.43	2092.91	2217.41
	36"(914mm)	E2FN-338-■ ■	1350.87	1479.99	1633.75	1990.37	2228.09	2357.15
	42"(1067mm)	E2FN-4238-■ ■	1426.77	1560.45	1723.33	2107.31	2363.27	2496.89
	48"(1219mm)	E2FN-438-■ ■	1500.33	1638.57	1810.57	2221.91	2496.11	2634.29
	60"(1524mm)	E2FN-538-■ ■	1649.79	1797.15	1987.39	2453.45	2764.13	2911.43
48"(1219mm)	24"(610mm)	E2FN-246-■ ■	\$ 1277.03	\$ 1400.87	\$ 1544.07	\$ 1869.01	\$ 2085.61	\$ 2209.39
	30"(762mm)	E2FN-3046-■ ■	1366.37	1495.73	1649.97	2008.03	2246.71	2376.01
	36"(914mm)	E2FN-346-■ ■	1455.71	1590.59	1755.87	2147.05	2407.81	2542.63
	42"(1067mm)	E2FN-4246-■ ■	1545.05	1685.45	1861.77	2286.07	2568.91	2709.25
	48"(1219mm)	E2FN-446-■ ■	1634.39	1780.31	1967.67	2425.09	2730.01	2875.87
	60"(1524mm)	E2FN-546-■ ■	1813.07	1970.03	2179.47	2703.13	3052.21	3209.11
56"(1422mm)	24"(610mm)	E2FN-254-■ ■	\$ 1352.65	\$ 1480.33	\$ 1631.21	\$ 1979.19	\$ 2211.15	\$ 2338.77
	30"(762mm)	E2FN-3054-■ ■	1457.77	1591.93	1755.77	2142.63	2400.51	2534.61
	36"(914mm)	E2FN-354-■ ■	1560.55	1701.19	1877.99	2303.73	2587.53	2728.11
	42"(1067mm)	E2FN-4254-■ ■	1663.33	1810.45	2000.21	2464.83	2774.55	2921.61
	48"(1219mm)	E2FN-454-■ ■	1766.11	1919.71	2122.43	2625.93	2961.57	3115.11
	60"(1524mm)	E2FN-554-■ ■	1974.01	2140.57	2369.21	2950.47	3337.95	3504.45
64"(1626mm)	24"(610mm)	E2FN-262-■ ■	\$ 1430.61	\$ 1562.13	\$ 1720.69	\$ 2091.71	\$ 2339.03	\$ 2470.49
	30"(762mm)	E2FN-3062-■ ■	1546.83	1685.79	1859.23	2274.89	2551.97	2690.87
	36"(914mm)	E2FN-362-■ ■	1665.39	1811.79	2000.11	2460.41	2767.25	2913.59
	42"(1067mm)	E2FN-4262-■ ■	1783.95	1937.79	2140.99	2645.93	2982.53	3136.31
	48"(1219mm)	E2FN-462-■ ■	1900.17	2061.45	2279.53	2829.11	3195.47	3356.69
	60"(1524mm)	E2FN-562-■ ■	2134.95	2311.11	2558.95	3197.81	3623.69	3799.79
72"(1829mm)	24"(610mm)	E2FN-270-■ ■	\$ 1506.23	\$ 1641.59	\$ 1807.83	\$ 2201.89	\$ 2464.57	\$ 2599.87
	30"(762mm)	E2FN-3070-■ ■	1638.23	1781.99	1965.03	2409.49	2705.77	2849.47
	36"(914mm)	E2FN-370-■ ■	1770.23	1922.39	2122.23	2617.09	2946.97	3099.07
	42"(1067mm)	E2FN-4270-■ ■	1902.23	2062.79	2279.43	2824.69	3188.17	3348.67
	48"(1219mm)	E2FN-470-■ ■	2034.23	2203.19	2436.63	3032.29	3429.37	3598.27
	60"(1524mm)	E2FN-570-■ ■	2298.23	2483.99	2751.03	3447.49	3911.77	4097.47
80"(2032mm)	24"(610mm)	E2FN-278-■ ■	\$ 1581.85	\$ 1721.05	\$ 1894.97	\$ 2312.07	\$ 2590.11	\$ 2729.25
	30"(762mm)	E2FN-3078-■ ■	1729.63	1878.19	2070.83	2544.09	2859.57	3008.07
	36"(914mm)	E2FN-378-■ ■	1875.07	2032.99	2244.35	2773.77	3126.69	3284.55
	42"(1067mm)	E2FN-4278-■ ■	2020.51	2187.79	2417.87	3003.45	3393.81	3561.03
	48"(1219mm)	E2FN-478-■ ■	2165.95	2342.59	2591.39	3233.13	3660.93	3837.51
	60"(1524mm)	E2FN-578-■ ■	2459.17	2654.53	2940.77	3694.83	4197.51	4392.81

Fabric Monolithic Panel — No Power

UniGroup Too

Actual Height	Width	Number ①	Trim B Fabric					
			A	B	C	E	F	G
32"(813mm)	24"(610mm)	E2FN-230-■ ■	\$ 1139.88	\$ 1256.04	\$ 1383.88	\$ 1662.74	\$ 1848.62	\$ 1964.72
	30"(762mm)	E2FN-3030-■ ■	1203.42	1323.18	1458.22	1758.68	1958.96	2078.66
	36"(914mm)	E2FN-330-■ ■	1264.62	1387.98	1530.22	1852.28	2066.96	2190.26
	42"(1067mm)	E2FN-4230-■ ■	1325.82	1452.78	1602.22	1945.88	2174.96	2301.86
	48"(1219mm)	E2FN-430-■ ■	1387.02	1517.58	1674.22	2039.48	2282.96	2413.46
	60"(1524mm)	E2FN-530-■ ■	1511.76	1649.52	1820.56	2229.02	2501.30	2639.00
40"(1016mm)	24"(610mm)	E2FN-238-■ ■	\$ 1218.96	\$ 1338.96	\$ 1474.48	\$ 1776.38	\$ 1977.62	\$ 2097.56
	30"(762mm)	E2FN-3038-■ ■	1293.60	1418.16	1562.80	1892.06	2111.54	2236.04
	36"(914mm)	E2FN-338-■ ■	1370.58	1499.70	1653.46	2010.08	2247.80	2376.86
	42"(1067mm)	E2FN-4238-■ ■	1447.56	1581.24	1744.12	2128.10	2384.06	2517.68
	48"(1219mm)	E2FN-438-■ ■	1522.20	1660.44	1832.44	2243.78	2517.98	2656.16
	60"(1524mm)	E2FN-538-■ ■	1673.82	1821.18	2011.42	2477.48	2788.16	2935.46
48"(1219mm)	24"(610mm)	E2FN-246-■ ■	\$ 1295.70	\$ 1419.54	\$ 1562.74	\$ 1887.68	\$ 2104.28	\$ 2228.06
	30"(762mm)	E2FN-3046-■ ■	1386.12	1515.48	1669.72	2027.78	2266.46	2395.76
	36"(914mm)	E2FN-346-■ ■	1476.54	1611.42	1776.70	2167.88	2428.64	2563.46
	42"(1067mm)	E2FN-4246-■ ■	1566.96	1707.36	1883.68	2307.98	2590.82	2731.16
	48"(1219mm)	E2FN-446-■ ■	1657.38	1803.30	1990.66	2448.08	2753.00	2898.86
	60"(1524mm)	E2FN-546-■ ■	1838.22	1995.18	2204.62	2728.28	3077.36	3234.26
56"(1422mm)	24"(610mm)	E2FN-254-■ ■	\$ 1372.44	\$ 1500.12	\$ 1651.00	\$ 1998.98	\$ 2230.94	\$ 2358.56
	30"(762mm)	E2FN-3054-■ ■	1478.64	1612.80	1776.64	2163.50	2421.38	2555.48
	36"(914mm)	E2FN-354-■ ■	1582.50	1723.14	1899.94	2325.68	2609.48	2750.06
	42"(1067mm)	E2FN-4254-■ ■	1686.36	1833.48	2023.24	2487.86	2797.58	2944.64
	48"(1219mm)	E2FN-454-■ ■	1790.22	1943.82	2146.54	2650.04	2985.68	3139.22
	60"(1524mm)	E2FN-554-■ ■	2000.28	2166.84	2395.48	2976.74	3364.22	3530.72
64"(1626mm)	24"(610mm)	E2FN-262-■ ■	\$ 1451.52	\$ 1583.04	\$ 1741.60	\$ 2112.62	\$ 2359.94	\$ 2491.40
	30"(762mm)	E2FN-3062-■ ■	1568.82	1707.78	1881.22	2296.88	2573.96	2712.86
	36"(914mm)	E2FN-362-■ ■	1688.46	1834.86	2023.18	2483.48	2790.32	2936.66
	42"(1067mm)	E2FN-4262-■ ■	1808.10	1961.94	2165.14	2670.08	3006.68	3160.46
	48"(1219mm)	E2FN-462-■ ■	1925.40	2086.68	2304.76	2854.34	3220.70	3381.92
	60"(1524mm)	E2FN-562-■ ■	2162.34	2338.50	2586.34	3225.20	3651.08	3827.18
72"(1829mm)	24"(610mm)	E2FN-270-■ ■	\$ 1528.26	\$ 1663.62	\$ 1829.86	\$ 2223.92	\$ 2486.60	\$ 2621.90
	30"(762mm)	E2FN-3070-■ ■	1661.34	1805.10	1988.14	2432.60	2728.88	2872.58
	36"(914mm)	E2FN-370-■ ■	1794.42	1946.58	2146.42	2641.28	2971.16	3123.26
	42"(1067mm)	E2FN-4270-■ ■	1927.50	2088.06	2304.70	2849.96	3213.44	3373.94
	48"(1219mm)	E2FN-470-■ ■	2060.58	2229.54	2462.98	3058.64	3455.72	3624.62
	60"(1524mm)	E2FN-570-■ ■	2326.74	2512.50	2779.54	3476.00	3940.28	4125.98
80"(2032mm)	24"(610mm)	E2FN-278-■ ■	\$ 1605.00	\$ 1744.20	\$ 1918.12	\$ 2335.22	\$ 2613.26	\$ 2752.40
	30"(762mm)	E2FN-3078-■ ■	1753.86	1902.42	2095.06	2568.32	2883.80	3032.30
	36"(914mm)	E2FN-378-■ ■	1900.38	2058.30	2269.66	2799.08	3152.00	3309.86
	42"(1067mm)	E2FN-4278-■ ■	2046.90	2214.18	2444.26	3029.84	3420.20	3587.42
	48"(1219mm)	E2FN-478-■ ■	2193.42	2370.06	2618.86	3260.60	3688.40	3864.98
	60"(1524mm)	E2FN-578-■ ■	2488.80	2684.16	2970.40	3724.46	4227.14	4422.44

Fabric Monolithic Panel — Powered

UniGroup Too

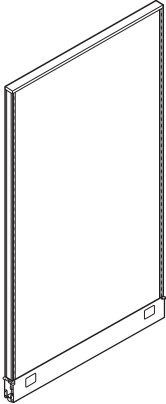

E2FP-B (3-circuit)
Class AC



Note: This panel has fabric/colorway restrictions, see systems fabrics/ color legend.

Features

- Includes powered panel assembly, square top cap with aligner, with or without one-piece base raceway cover, 1.6 hinge kits, side trim rails, leveling glides and carpet gripper; power distribution assembly/flex connector(s). .6 top cap end plugs and base raceway end caps are shipped with each panel. Order additional as necessary.
- High acoustical panel surfaces over 0.5”(13mm) thick fiber board.
- Panel surfaces may have the same fabric on both sides or a different fabric on each side.
- Panel thickness is 2”(51mm).
- Base raceway is 4”(102mm)H.
- Powered raceway with or without raceway cover requires modified catalog number and list price.
- Powered panels are available for countries that utilize 120 volt 60 hertz electrical systems and U.S. configured plugs and outlets.
- Shipped with unassembled top cap, base raceway cover and side trim rails.

Specification Tips

- Panels will accept add-on panels up to a combined height of 80”(2032mm). For aesthetic consistency, specify UniGroup Too add-on panels.
- Flex connectors provided for powered monolithic panels accommodate straight in-line, inside 90°, and inside 120° conditions (if applicable).
- Receptacles for powered panels must be specified separately.
- Raceway cover must be separately specified for option -BE or BYE (no raceway cover).
- If 90° top cap for four-way and 120° top cap for three-way are not specified, additional top cap end plugs will need to be ordered.
- Additional top cap end plugs and base raceway end caps will need to be specified if finish posts are not ordered.

To Order, Specify:

1) Product number, including:

1 3-Circuit

B With Raceway Cover

BE Without Raceway Cover
(deduct **\$138.36** list)

BY NYC with Raceway Cover

BYE NYC without Raceway Cover
(deduct **\$138.36** list)

- 2) Fabric/colorway for panel side one.
- 3) Fabric side two.
- 4) Trim color raceway cover, glide housings and end caps. Not available in metallic trim colors.
- 5) Trim color for top cap and side trim rails.

Note: Upcharge for mixed surface grades, refer to the electronic design and specification tools for pricing.

Notes:

- Powered panels with raceway covers ship with receptacle ports in the base raceway cover. Receptacle ports on the raceway cover measure 2.35”(60mm) top-to-bottom and 2.88”(73mm) side-to-side.
- Powered panels with Power Distribution Assemblies (PDA) but without raceway covers require separately specified base raceway covers for power and communication port locations other than the standard powered base raceway cover.
- New York City (NYC) electrical applications require field installation of PDA.
- New York Port Authority (NYPA) electrical applications require metal raceway covers. To order, specify NYC powered panels without raceway cover and separately specify metal covers through Haworth e-Parts.
- Some building codes may restrict the use of panel heights greater than 69”(1753mm). Consult your local code authority to assure that the furniture layout is compliant.
- For International Power, specify non-powered panels and use Power Logic components. See Specification Guide for more information on Power Logic.
- For Chicago power, specify non-powered panels without a base raceway cover and separately specify Chicago power retrofit kit.

Fabric Monolithic Panel — Powered

UniGroup Too

Actual Height	Width	Number ①	Trim A Fabric					
			A	B	C	E	F	G
32"(813mm)	24"(610mm)	E2FP-230-■ ■	\$ 1574.49	\$ 1690.65	\$ 1818.49	\$ 2097.35	\$ 2283.23	\$ 2399.33
	30"(762mm)	E2FP-3030-■ ■	1636.95	1756.71	1891.75	2192.21	2392.49	2512.19
	36"(914mm)	E2FP-330-■ ■	1697.07	1820.43	1962.67	2284.73	2499.41	2622.71
	42"(1067mm)	E2FP-4230-■ ■	1757.19	1884.15	2033.59	2377.25	2606.33	2733.23
	48"(1219mm)	E2FP-430-■ ■	1817.31	1947.87	2104.51	2469.77	2713.25	2843.75
	60"(1524mm)	E2FP-530-■ ■	1939.89	2077.65	2248.69	2657.15	2929.43	3067.13
40"(1016mm)	24"(610mm)	E2FP-238-■ ■	\$ 1652.45	\$ 1772.45	\$ 1907.97	\$ 2209.87	\$ 2411.11	\$ 2531.05
	30"(762mm)	E2FP-3038-■ ■	1726.01	1850.57	1995.21	2324.47	2543.95	2668.45
	36"(914mm)	E2FP-338-■ ■	1801.91	1931.03	2084.79	2441.41	2679.13	2808.19
	42"(1067mm)	E2FP-4238-■ ■	1877.81	2011.49	2174.37	2558.35	2814.31	2947.93
	48"(1219mm)	E2FP-438-■ ■	1951.37	2089.61	2261.61	2672.95	2947.15	3085.33
	60"(1524mm)	E2FP-538-■ ■	2100.83	2248.19	2438.43	2904.49	3215.17	3362.47
48"(1219mm)	24"(610mm)	E2FP-246-■ ■	\$ 1728.07	\$ 1851.91	\$ 1995.11	\$ 2320.05	\$ 2536.65	\$ 2660.43
	30"(762mm)	E2FP-3046-■ ■	1817.41	1946.77	2101.01	2459.07	2697.75	2827.05
	36"(914mm)	E2FP-346-■ ■	1906.75	2041.63	2206.91	2598.09	2858.85	2993.67
	42"(1067mm)	E2FP-4246-■ ■	1996.09	2136.49	2312.81	2737.11	3019.95	3160.29
	48"(1219mm)	E2FP-446-■ ■	2085.43	2231.35	2418.71	2876.13	3181.05	3326.91
	60"(1524mm)	E2FP-546-■ ■	2264.11	2421.07	2630.51	3154.17	3503.25	3660.15
56"(1422mm)	24"(610mm)	E2FP-254-■ ■	\$ 1803.69	\$ 1931.37	\$ 2082.25	\$ 2430.23	\$ 2662.19	\$ 2789.81
	30"(762mm)	E2FP-3054-■ ■	1908.81	2042.97	2206.81	2593.67	2851.55	2985.65
	36"(914mm)	E2FP-354-■ ■	2011.59	2152.23	2329.03	2754.77	3038.57	3179.15
	42"(1067mm)	E2FP-4254-■ ■	2114.37	2261.49	2451.25	2915.87	3225.59	3372.65
	48"(1219mm)	E2FP-454-■ ■	2217.15	2370.75	2573.47	3076.97	3412.61	3566.15
	60"(1524mm)	E2FP-554-■ ■	2425.05	2591.61	2820.25	3401.51	3788.99	3955.49
64"(1626mm)	24"(610mm)	E2FP-262-■ ■	\$ 1881.65	\$ 2013.17	\$ 2171.73	\$ 2542.75	\$ 2790.07	\$ 2921.53
	30"(762mm)	E2FP-3062-■ ■	1997.87	2136.83	2310.27	2725.93	3003.01	3141.91
	36"(914mm)	E2FP-362-■ ■	2116.43	2262.83	2451.15	2911.45	3218.29	3364.63
	42"(1067mm)	E2FP-4262-■ ■	2234.99	2388.83	2592.03	3096.97	3433.57	3587.35
	48"(1219mm)	E2FP-462-■ ■	2351.21	2512.49	2730.57	3280.15	3646.51	3807.73
	60"(1524mm)	E2FP-562-■ ■	2585.99	2762.15	3009.99	3648.85	4074.73	4250.83
72"(1829mm)	24"(610mm)	E2FP-270-■ ■	\$ 1957.27	\$ 2092.63	\$ 2258.87	\$ 2652.93	\$ 2915.61	\$ 3050.91
	30"(762mm)	E2FP-3070-■ ■	2089.27	2233.03	2416.07	2860.53	3156.81	3300.51
	36"(914mm)	E2FP-370-■ ■	2221.27	2373.43	2573.27	3068.13	3398.01	3550.11
	42"(1067mm)	E2FP-4270-■ ■	2353.27	2513.83	2730.47	3275.73	3639.21	3799.71
	48"(1219mm)	E2FP-470-■ ■	2485.27	2654.23	2887.67	3483.33	3880.41	4049.31
	60"(1524mm)	E2FP-570-■ ■	2749.27	2935.03	3202.07	3898.53	4362.81	4548.51
80"(2032mm)	24"(610mm)	E2FP-278-■ ■	\$ 2032.89	\$ 2172.09	\$ 2346.01	\$ 2763.11	\$ 3041.15	\$ 3180.29
	30"(762mm)	E2FP-3078-■ ■	2180.67	2329.23	2521.87	2995.13	3310.61	3459.11
	36"(914mm)	E2FP-378-■ ■	2326.11	2484.03	2695.39	3224.81	3577.73	3735.59
	42"(1067mm)	E2FP-4278-■ ■	2471.55	2638.83	2868.91	3454.49	3844.85	4012.07
	48"(1219mm)	E2FP-478-■ ■	2616.99	2793.63	3042.43	3684.17	4111.97	4288.55
	60"(1524mm)	E2FP-578-■ ■	2910.21	3105.57	3391.81	4145.87	4648.55	4843.85

Fabric Monolithic Panel — Powered

UniGroup Too

Actual Height	Width	Number ①	Trim B Fabric					
			A	B	C	E	F	G
32"(813mm)	24"(610mm)	E2FP-230-■ ■	\$ 1590.92	\$ 1707.08	\$ 1834.92	\$ 2113.78	\$ 2299.66	\$ 2415.76
	30"(762mm)	E2FP-3030-■ ■	1654.46	1774.22	1909.26	2209.72	2410.00	2529.70
	36"(914mm)	E2FP-330-■ ■	1715.66	1839.02	1981.26	2303.32	2518.00	2641.30
	42"(1067mm)	E2FP-4230-■ ■	1776.86	1903.82	2053.26	2396.92	2626.00	2752.90
	48"(1219mm)	E2FP-430-■ ■	1838.06	1968.62	2125.26	2490.52	2734.00	2864.50
	60"(1524mm)	E2FP-530-■ ■	1962.80	2100.56	2271.60	2680.06	2952.34	3090.04
40"(1016mm)	24"(610mm)	E2FP-238-■ ■	\$ 1670.00	\$ 1790.00	\$ 1925.52	\$ 2227.42	\$ 2428.66	\$ 2548.60
	30"(762mm)	E2FP-3038-■ ■	1744.64	1869.20	2013.84	2343.10	2562.58	2687.08
	36"(914mm)	E2FP-338-■ ■	1821.62	1950.74	2104.50	2461.12	2698.84	2827.90
	42"(1067mm)	E2FP-4238-■ ■	1898.60	2032.28	2195.16	2579.14	2835.10	2968.72
	48"(1219mm)	E2FP-438-■ ■	1973.24	2111.48	2283.48	2694.82	2969.02	3107.20
	60"(1524mm)	E2FP-538-■ ■	2124.86	2272.22	2462.46	2928.52	3239.20	3386.50
48"(1219mm)	24"(610mm)	E2FP-246-■ ■	\$ 1746.74	\$ 1870.58	\$ 2013.78	\$ 2338.72	\$ 2555.32	\$ 2679.10
	30"(762mm)	E2FP-3046-■ ■	1837.16	1966.52	2120.76	2478.82	2717.50	2846.80
	36"(914mm)	E2FP-346-■ ■	1927.58	2062.46	2227.74	2618.92	2879.68	3014.50
	42"(1067mm)	E2FP-4246-■ ■	2018.00	2158.40	2334.72	2759.02	3041.86	3182.20
	48"(1219mm)	E2FP-446-■ ■	2108.42	2254.34	2441.70	2899.12	3204.04	3349.90
	60"(1524mm)	E2FP-546-■ ■	2289.26	2446.22	2655.66	3179.32	3528.40	3685.30
56"(1422mm)	24"(610mm)	E2FP-254-■ ■	\$ 1823.48	\$ 1951.16	\$ 2102.04	\$ 2450.02	\$ 2681.98	\$ 2809.60
	30"(762mm)	E2FP-3054-■ ■	1929.68	2063.84	2227.68	2614.54	2872.42	3006.52
	36"(914mm)	E2FP-354-■ ■	2033.54	2174.18	2350.98	2776.72	3060.52	3201.10
	42"(1067mm)	E2FP-4254-■ ■	2137.40	2284.52	2474.28	2938.90	3248.62	3395.68
	48"(1219mm)	E2FP-454-■ ■	2241.26	2394.86	2597.58	3101.08	3436.72	3590.26
	60"(1524mm)	E2FP-554-■ ■	2451.32	2617.88	2846.52	3427.78	3815.26	3981.76
64"(1626mm)	24"(610mm)	E2FP-262-■ ■	\$ 1902.56	\$ 2034.08	\$ 2192.64	\$ 2563.66	\$ 2810.98	\$ 2942.44
	30"(762mm)	E2FP-3062-■ ■	2019.86	2158.82	2332.26	2747.92	3025.00	3163.90
	36"(914mm)	E2FP-362-■ ■	2139.50	2285.90	2474.22	2934.52	3241.36	3387.70
	42"(1067mm)	E2FP-4262-■ ■	2259.14	2412.98	2616.18	3121.12	3457.72	3611.50
	48"(1219mm)	E2FP-462-■ ■	2376.44	2537.72	2755.80	3305.38	3671.74	3832.96
	60"(1524mm)	E2FP-562-■ ■	2613.38	2789.54	3037.38	3676.24	4102.12	4278.22
72"(1829mm)	24"(610mm)	E2FP-270-■ ■	\$ 1979.30	\$ 2114.66	\$ 2280.90	\$ 2674.96	\$ 2937.64	\$ 3072.94
	30"(762mm)	E2FP-3070-■ ■	2112.38	2256.14	2439.18	2883.64	3179.92	3323.62
	36"(914mm)	E2FP-370-■ ■	2245.46	2397.62	2597.46	3092.32	3422.20	3574.30
	42"(1067mm)	E2FP-4270-■ ■	2378.54	2539.10	2755.74	3301.00	3664.48	3824.98
	48"(1219mm)	E2FP-470-■ ■	2511.62	2680.58	2914.02	3509.68	3906.76	4075.66
	60"(1524mm)	E2FP-570-■ ■	2777.78	2963.54	3230.58	3927.04	4391.32	4577.02
80"(2032mm)	24"(610mm)	E2FP-278-■ ■	\$ 2056.04	\$ 2195.24	\$ 2369.16	\$ 2786.26	\$ 3064.30	\$ 3203.44
	30"(762mm)	E2FP-3078-■ ■	2204.90	2353.46	2546.10	3019.36	3334.84	3483.34
	36"(914mm)	E2FP-378-■ ■	2351.42	2509.34	2720.70	3250.12	3603.04	3760.90
	42"(1067mm)	E2FP-4278-■ ■	2497.94	2665.22	2895.30	3480.88	3871.24	4038.46
	48"(1219mm)	E2FP-478-■ ■	2644.46	2821.10	3069.90	3711.64	4139.44	4316.02
	60"(1524mm)	E2FP-578-■ ■	2939.84	3135.20	3421.44	4175.50	4678.18	4873.48

Monolithic Panel with Full-Height Inserts — No Power

UniGroup Too

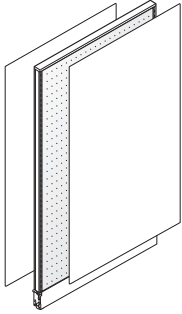

E2LN-B (Non-Powered)
Class AC

Features

- Includes non-powered full-height panel core assembly, monolithic panel inserts square top cap with aligner, with or without one-piece base raceway cover, 1.6 hinge kits, side trim rails, leveling glides and carpet gripper. .6 top cap end plugs and base raceway end caps are shipped with each panel. Order additional as necessary.
- Acoustical panel surfaces bonded to compressed fiberboard for moderate tackable properties.
- Each insert may have the same fabric or a different fabric.
- Panel thickness is 2"(51mm).
- Base raceway is 4"(102mm)H.
- Shipped with unassembled inserts, top cap, base raceway cover and side trim rails.
- Inserts may easily be changed on installed monolithic panels without components.
- Can be field-modified from full-height monolithic panel insert to segmented panel inserts.

Specification Tips

- Panels will accept add-on panels up to a combined height of 80"(2032mm). For aesthetic consistency, specify UniGroup Too add-on panels.
- Raceway cover must be separately specified for option -BE (no raceway cover).
- If 90° top cap for four-way and 120° top cap for three-way are not specified, additional top cap end plugs will need to be ordered.
- Additional top cap end plugs and base raceway end caps will need to be specified if finish posts are not ordered.

To Order, Specify:

- 1) Product number, including:

① Options:

B With Raceway Cover

BE Without Raceway Cover
(deduct **\$98.65** list)

- 2) Fabric/colorway for panel insert side one.
- 3) Fabric/colorway for panel insert side two.
- 4) Trim color raceway cover, glide housings and end caps. Not available in metallic trim colors.
- 5) Trim color for top cap and side trim rails.

Note: Upcharge for mixed surface grades, refer to the electronic design and specification tools for pricing.

Notes:

- Non-powered panels ship without receptacle ports in the base raceway cover.
- Some building codes may restrict the use of panel heights greater than 69"(1753mm). Consult your local code authority to assure that the furniture layout is compliant.
- For International Power, specify non-powered panels and use Power Logic components. See Specification Guide for more information on Power Logic.
- For Chicago power, specify non-powered panels without a base raceway cover and separately specify Chicago power retrofit kit.

Monolithic Panel with Full-Height Inserts — No Power

UniGroup Too

Actual Height	Width	Number ①	Trim A Fabric					
			A	B	C	E	F	G
32"(813mm)	24"(610mm)	E2LN-230-■ ■ FF	\$ 1112.35	\$ 1167.53	\$ 1230.01	\$ 1362.41	\$ 1454.33	\$ 1509.43
	30"(762mm)	E2LN-3030-■ ■ FF	1193.10	1252.26	1319.34	1461.42	1560.06	1619.20
	36"(914mm)	E2LN-330-■ ■ FF	1273.85	1336.99	1408.67	1560.43	1665.79	1728.97
	42"(1067mm)	E2LN-4230-■ ■ FF	1354.60	1421.72	1498.00	1659.44	1771.52	1838.74
	48"(1219mm)	E2LN-430-■ ■ FF	1435.35	1506.45	1587.33	1758.45	1877.25	1948.51
	60"(1524mm)	E2LN-530-■ ■ FF	1596.85	1675.91	1765.99	1956.47	2088.71	2168.05
40"(1016mm)	24"(610mm)	E2LN-238-■ ■ FF	\$ 1202.04	\$ 1265.82	\$ 1330.50	\$ 1473.16	\$ 1569.14	\$ 1627.82
	30"(762mm)	E2LN-3038-■ ■ FF	1304.31	1372.07	1441.35	1593.69	1696.39	1759.11
	36"(914mm)	E2LN-338-■ ■ FF	1385.06	1456.80	1530.68	1692.70	1802.12	1868.88
	42"(1067mm)	E2LN-4238-■ ■ FF	1465.81	1541.53	1620.01	1791.71	1907.85	1978.65
	48"(1219mm)	E2LN-438-■ ■ FF	1546.56	1626.26	1709.34	1890.72	2013.58	2088.42
	60"(1524mm)	E2LN-538-■ ■ FF	1708.06	1795.72	1888.00	2088.74	2225.04	2307.96
48"(1219mm)	24"(610mm)	E2LN-246-■ ■ FF	\$ 1291.73	\$ 1364.11	\$ 1430.99	\$ 1583.91	\$ 1683.95	\$ 1746.21
	30"(762mm)	E2LN-3046-■ ■ FF	1394.00	1470.36	1541.84	1704.44	1811.20	1877.50
	36"(914mm)	E2LN-346-■ ■ FF	1474.75	1555.09	1631.17	1803.45	1916.93	1987.27
	42"(1067mm)	E2LN-4246-■ ■ FF	1555.50	1639.82	1720.50	1902.46	2022.66	2097.04
	48"(1219mm)	E2LN-446-■ ■ FF	1636.25	1724.55	1809.83	2001.47	2128.39	2206.81
	60"(1524mm)	E2LN-546-■ ■ FF	1797.75	1894.01	1988.49	2199.49	2339.85	2426.35
56"(1422mm)	24"(610mm)	E2LN-254-■ ■ FF	\$ 1381.42	\$ 1462.40	\$ 1531.48	\$ 1694.66	\$ 1798.76	\$ 1864.60
	30"(762mm)	E2LN-3054-■ ■ FF	1483.69	1568.65	1642.33	1815.19	1926.01	1995.89
	36"(914mm)	E2LN-354-■ ■ FF	1564.44	1653.38	1731.66	1914.20	2031.74	2105.66
	42"(1067mm)	E2LN-4254-■ ■ FF	1742.00	1834.92	1917.80	2110.02	2234.28	2312.24
	48"(1219mm)	E2LN-454-■ ■ FF	1855.02	1951.92	2039.40	2241.30	2372.28	2454.28
	60"(1524mm)	E2LN-554-■ ■ FF	2081.06	2185.92	2282.60	2503.86	2648.28	2738.36
64"(1626mm)	24"(610mm)	E2LN-262-■ ■ FF	\$ 1561.11	\$ 1650.69	\$ 1721.97	\$ 1895.41	\$ 2003.57	\$ 2072.99
	30"(762mm)	E2LN-3062-■ ■ FF	1663.38	1756.94	1832.82	2015.94	2130.82	2204.28
	36"(914mm)	E2LN-362-■ ■ FF	1815.87	1913.41	1993.89	2186.69	2308.29	2385.79
	42"(1067mm)	E2LN-4262-■ ■ FF	1932.49	2034.01	2119.09	2321.57	2449.89	2531.43
	48"(1219mm)	E2LN-462-■ ■ FF	2049.11	2154.61	2244.29	2456.45	2591.49	2677.07
	60"(1524mm)	E2LN-562-■ ■ FF	2282.35	2395.81	2494.69	2726.21	2874.69	2968.35
72"(1829mm)	24"(610mm)	E2LN-270-■ ■ FF	\$ 1650.80	\$ 1748.98	\$ 1822.46	\$ 2006.16	\$ 2118.38	\$ 2191.38
	30"(762mm)	E2LN-3070-■ ■ FF	1797.91	1900.07	1978.15	2171.53	2290.47	2367.51
	36"(914mm)	E2LN-370-■ ■ FF	1923.50	2029.64	2112.32	2315.38	2441.04	2522.12
	42"(1067mm)	E2LN-4270-■ ■ FF	2049.09	2159.21	2246.49	2459.23	2591.61	2676.73
	48"(1219mm)	E2LN-470-■ ■ FF	2174.68	2288.78	2380.66	2603.08	2742.18	2831.34
	60"(1524mm)	E2LN-570-■ ■ FF	2425.86	2547.92	2649.00	2890.78	3043.32	3140.56
80"(2032mm)	24"(610mm)	E2LN-278-■ ■ FF	\$ 1901.93	\$ 2008.71	\$ 2084.39	\$ 2278.35	\$ 2394.63	\$ 2471.21
	30"(762mm)	E2LN-3078-■ ■ FF	2102.85	2213.61	2293.89	2497.53	2620.53	2701.15
	36"(914mm)	E2LN-378-■ ■ FF	2282.25	2396.99	2481.87	2695.19	2824.91	2909.57
	42"(1067mm)	E2LN-4278-■ ■ FF	2461.65	2580.37	2669.85	2892.85	3029.29	3117.99
	48"(1219mm)	E2LN-478-■ ■ FF	2641.05	2763.75	2857.83	3090.51	3233.67	3326.41
	60"(1524mm)	E2LN-578-■ ■ FF	2999.85	3130.51	3233.79	3485.83	3642.43	3743.25

Monolithic Panel with Full-Height Inserts — No Power

UniGroup Too

Actual Height	Width	Number ①	Trim B Fabric					
			A	B	C	E	F	G
32"(813mm)	24"(610mm)	E2LN-230-■ ■ FF	\$ 1177.75	\$ 1172.93	\$ 1235.41	\$ 1367.81	\$ 1459.73	\$ 1514.83
	30"(762mm)	E2LN-3030-■ ■ FF	1198.85	1258.01	1325.09	1467.17	1565.81	1624.95
	36"(914mm)	E2LN-330-■ ■ FF	1279.95	1343.09	1414.77	1566.53	1671.89	1735.07
	42"(1067mm)	E2LN-4230-■ ■ FF	1361.05	1428.17	1504.45	1665.89	1777.97	1845.19
	48"(1219mm)	E2LN-430-■ ■ FF	1442.15	1513.25	1594.13	1765.25	1884.05	1955.31
	60"(1524mm)	E2LN-530-■ ■ FF	1604.35	1683.41	1773.49	1963.97	2096.21	2175.55
40"(1016mm)	24"(610mm)	E2LN-238-■ ■ FF	\$ 1208.34	\$ 1272.12	\$ 1336.80	\$ 1479.46	\$ 1575.44	\$ 1634.12
	30"(762mm)	E2LN-3038-■ ■ FF	1310.96	1378.72	1448.00	1600.34	1703.04	1765.76
	36"(914mm)	E2LN-338-■ ■ FF	1392.06	1463.80	1537.68	1699.70	1809.12	1875.88
	42"(1067mm)	E2LN-4238-■ ■ FF	1473.16	1548.88	1627.36	1799.06	1915.20	1986.00
	48"(1219mm)	E2LN-438-■ ■ FF	1554.26	1633.96	1717.04	1898.42	2021.28	2096.12
	60"(1524mm)	E2LN-538-■ ■ FF	1716.46	1804.12	1896.40	2097.14	2233.44	2316.36
48"(1219mm)	24"(610mm)	E2LN-246-■ ■ FF	\$ 1298.93	\$ 1371.31	\$ 1438.19	\$ 1591.11	\$ 1691.15	\$ 1753.41
	30"(762mm)	E2LN-3046-■ ■ FF	1401.55	1477.91	1549.39	1711.99	1818.75	1885.05
	36"(914mm)	E2LN-346-■ ■ FF	1482.65	1562.99	1639.07	1811.35	1924.83	1995.17
	42"(1067mm)	E2LN-4246-■ ■ FF	1563.75	1648.07	1728.75	1910.71	2030.91	2105.29
	48"(1219mm)	E2LN-446-■ ■ FF	1644.85	1733.15	1818.43	2010.07	2136.99	2215.41
	60"(1524mm)	E2LN-546-■ ■ FF	1807.05	1903.31	1997.79	2208.79	2349.15	2435.65
56"(1422mm)	24"(610mm)	E2LN-254-■ ■ FF	\$ 1389.52	\$ 1470.50	\$ 1539.58	\$ 1702.76	\$ 1806.86	\$ 1872.70
	30"(762mm)	E2LN-3054-■ ■ FF	1492.14	1577.10	1650.78	1823.64	1934.46	2004.34
	36"(914mm)	E2LN-354-■ ■ FF	1573.24	1662.18	1740.46	1923.00	2040.54	2114.46
	42"(1067mm)	E2LN-4254-■ ■ FF	1751.15	1844.07	1926.95	2119.17	2243.43	2321.39
	48"(1219mm)	E2LN-454-■ ■ FF	1864.52	1961.42	2048.90	2250.80	2381.78	2463.78
	60"(1524mm)	E2LN-554-■ ■ FF	2091.26	2196.12	2292.80	2514.06	2658.48	2748.56
64"(1626mm)	24"(610mm)	E2LN-262-■ ■ FF	\$ 1570.11	\$ 1659.69	\$ 1730.97	\$ 1904.41	\$ 2012.57	\$ 2081.99
	30"(762mm)	E2LN-3062-■ ■ FF	1672.73	1766.29	1842.17	2025.29	2140.17	2213.63
	36"(914mm)	E2LN-362-■ ■ FF	1825.57	1923.11	2003.59	2196.39	2317.99	2395.49
	42"(1067mm)	E2LN-4262-■ ■ FF	1942.54	2044.06	2129.14	2331.62	2459.94	2541.48
	48"(1219mm)	E2LN-462-■ ■ FF	2059.51	2165.01	2254.69	2466.85	2601.89	2687.47
	60"(1524mm)	E2LN-562-■ ■ FF	2293.45	2406.91	2505.79	2737.31	2885.79	2979.45
72"(1829mm)	24"(610mm)	E2LN-270-■ ■ FF	\$ 1660.70	\$ 1758.88	\$ 1832.36	\$ 2016.06	\$ 2128.28	\$ 2201.28
	30"(762mm)	E2LN-3070-■ ■ FF	1808.16	1910.32	1988.40	2181.78	2300.72	2377.76
	36"(914mm)	E2LN-370-■ ■ FF	1934.10	2040.24	2122.92	2325.98	2451.64	2532.72
	42"(1067mm)	E2LN-4270-■ ■ FF	2060.04	2170.16	2257.44	2470.18	2602.56	2687.68
	48"(1219mm)	E2LN-470-■ ■ FF	2185.98	2300.08	2391.96	2614.38	2753.48	2842.64
	60"(1524mm)	E2LN-570-■ ■ FF	2437.86	2559.92	2661.00	2902.78	3055.32	3152.56
80"(2032mm)	24"(610mm)	E2LN-278-■ ■ FF	\$ 1912.73	\$ 2019.51	\$ 2095.19	\$ 2289.15	\$ 2405.43	\$ 2482.01
	30"(762mm)	E2LN-3078-■ ■ FF	2114.00	2224.76	2305.04	2508.68	2631.68	2712.30
	36"(914mm)	E2LN-378-■ ■ FF	2293.75	2408.49	2493.37	2706.69	2836.41	2921.07
	42"(1067mm)	E2LN-4278-■ ■ FF	2473.50	2592.22	2681.70	2904.70	3041.14	3129.84
	48"(1219mm)	E2LN-478-■ ■ FF	2653.25	2775.95	2870.03	3102.71	3245.87	3338.61
	60"(1524mm)	E2LN-578-■ ■ FF	3012.75	3143.41	3246.69	3498.73	3655.33	3756.15

Monolithic Panel with Full-Height Inserts — Powered UniGroup Too

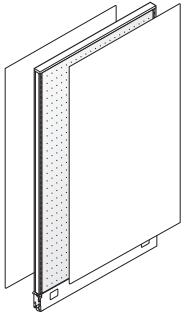

E2LP-B (3-circuit)
Class AC



Features

- Includes powered full-height panel core assembly, monolithic panel inserts square top cap with aligner, with or without one-piece base raceway cover, 1.6 hinge kits, side trim rails, leveling glides and carpet gripper; power distribution assembly/flex connector(s). .6 top cap end plugs and base raceway end caps are shipped with each panel. Order additional as necessary.
- Acoustical panel surfaces bonded to compressed fiber board moderate tackable properties.
- Each insert may have the same fabric or a different fabric.
- Panel thickness is 2"(51mm).
- Base raceway is 4"(102mm)H.
- Powered raceway with or without raceway cover requires modified catalog number and list price.
- Powered panels are available for countries that utilize 120 volt 60 hertz electrical systems and U.S. configured plugs and outlets.
- Shipped with unassembled inserts, top cap, base raceway cover and side trim rails.
- Inserts may easily be changed on installed monolithic panels without components.
- Can be field-modified from full-height monolithic panel insert to segmented panel inserts.

Specification Tips

- Panels will accept add-on panels up to a combined height of 80"(2032mm). For aesthetic consistency, specify UniGroup Too add-on panels.
- Flex connectors provided for powered monolithic panels accommodate straight in-line, inside 90°, and inside 120° conditions (if applicable).
- Receptacles for powered panels must be specified separately.
- Raceway cover must be separately specified for option -BE or BYE (no raceway cover).
- If 90° top cap for four-way and 120° top cap for three-way are not specified, additional top cap end plugs will need to be ordered.
- Additional top cap end plugs and base raceway end caps will need to be specified if finish posts are not ordered.

To Order, Specify:

1) Product number, including:

1 3-Circuit

- B** With Raceway Cover
- BE** Without Raceway Cover (deduct **\$127.34** list)
- BY** NYC with Raceway Cover
- BYE** NYC without Raceway Cover (deduct **\$127.34** list)

- 2) Fabric/colorway for panel insert side one.
- 3) Fabric/colorway for panel insert side two.
- 4) Trim color raceway cover, glide housings and end caps. Not available in metallic trim colors.
- 5) Trim color for top cap and side trim rails.

Note: Upcharge for mixed surface grades, refer to the electronic design and specification tools for pricing.

Notes:

- Powered panels with raceway covers ship with receptacle ports in the base raceway cover. Receptacle ports on the raceway cover measure 2.35"(60mm) top-to-bottom and 2.88"(73mm) side-to-side.
- Powered panels with Power Distribution Assemblies (PDA) but without raceway covers require separately specified base raceway covers for power and communication port locations other than the standard powered base raceway cover.
- New York City (NYC) electrical applications require field installation of PDA.
- New York Port Authority (NYPA) electrical applications require metal raceway covers. To order, specify NYC powered panels without raceway cover and separately specify metal covers through Haworth e-Parts.
- Some building codes may restrict the use of panel heights greater than 69"(1753mm). Consult your local code authority to assure that the furniture layout is compliant.
- For International Power, specify non-powered panels and use Power Logic components. See Specification Guide for more information on Power Logic.
- For Chicago power, specify non-powered panels without a base raceway cover and separately specify Chicago power retrofit kit.

Monolithic Panel with Full-Height Inserts — Powered UniGroup Too

Actual Height	Width	Number ①	Trim A Fabric					
			A	B	C	E	F	G
32"(813mm)	24"(610mm)	E2LP-230-■ ■ FF	\$ 1547.83	\$ 1603.01	\$ 1665.49	\$ 1797.89	\$ 1889.81	\$ 1944.91
	30"(762mm)	E2LP-3030-■ ■ FF	1628.58	1687.74	1754.82	1896.90	1995.54	2054.68
	36"(914mm)	E2LP-330-■ ■ FF	1709.33	1772.47	1844.15	1995.91	2101.27	2164.45
	42"(1067mm)	E2LP-4230-■ ■ FF	1790.08	1857.20	1933.48	2094.92	2207.00	2274.22
	48"(1219mm)	E2LP-430-■ ■ FF	1870.83	1941.93	2022.81	2193.93	2312.73	2383.99
	60"(1524mm)	E2LP-530-■ ■ FF	2032.33	2111.39	2201.47	2391.95	2524.19	2603.53
40"(1016mm)	24"(610mm)	E2LP-238-■ ■ FF	\$ 1637.52	\$ 1701.30	\$ 1765.98	\$ 1908.64	\$2004.62	\$2063.30
	30"(762mm)	E2LP-3038-■ ■ FF	1739.79	1807.55	1876.83	2029.17	2131.87	2194.59
	36"(914mm)	E2LP-338-■ ■ FF	1820.54	1892.28	1966.16	2128.18	2237.60	2304.36
	42"(1067mm)	E2LP-4238-■ ■ FF	1901.29	1977.01	2055.49	2227.19	2343.33	2414.13
	48"(1219mm)	E2LP-438-■ ■ FF	1982.04	2061.74	2144.82	2326.20	2449.06	2523.90
	60"(1524mm)	E2LP-538-■ ■ FF	2143.54	2231.20	2323.48	2524.22	2660.52	2743.44
48"(1219mm)	24"(610mm)	E2LP-246-■ ■ FF	\$ 1727.21	\$ 1799.59	\$ 1866.47	\$ 2019.39	\$ 2119.43	\$ 2181.69
	30"(762mm)	E2LP-3046-■ ■ FF	1829.48	1905.84	1977.32	2139.92	2246.68	2312.98
	36"(914mm)	E2LP-346-■ ■ FF	1910.23	1990.57	2066.65	2238.93	2352.41	2422.75
	42"(1067mm)	E2LP-4246-■ ■ FF	1990.98	2075.30	2155.98	2337.94	2458.14	2532.52
	48"(1219mm)	E2LP-446-■ ■ FF	2071.73	2160.03	2245.31	2436.95	2563.87	2642.29
	60"(1524mm)	E2LP-546-■ ■ FF	2233.23	2329.49	2423.97	2634.97	2775.33	2861.83
56"(1422mm)	24"(610mm)	E2LP-254-■ ■ FF	\$ 1816.90	\$ 1897.88	\$ 1966.96	\$ 2130.14	\$ 2234.24	\$2300.08
	30"(762mm)	E2LP-3054-■ ■ FF	1919.17	2004.13	2077.81	2250.67	2361.49	2431.37
	36"(914mm)	E2LP-354-■ ■ FF	1999.92	2088.86	2167.14	2349.68	2467.22	2541.14
	42"(1067mm)	E2LP-4254-■ ■ FF	2177.48	2270.40	2353.28	2545.50	2669.76	2747.72
	48"(1219mm)	E2LP-454-■ ■ FF	2290.50	2387.40	2474.88	2676.78	2807.76	2889.76
	60"(1524mm)	E2LP-554-■ ■ FF	2516.54	2621.40	2718.08	2939.34	3083.76	3173.84
64"(1626mm)	24"(610mm)	E2LP-262-■ ■ FF	\$ 1996.59	\$2086.17	\$ 2157.45	\$2330.89	\$ 2439.05	\$2508.47
	30"(762mm)	E2LP-3062-■ ■ FF	2098.86	2192.42	2268.30	2451.42	2566.30	2639.76
	36"(914mm)	E2LP-362-■ ■ FF	2251.35	2348.89	2429.37	2622.17	2743.77	2821.27
	42"(1067mm)	E2LP-4262-■ ■ FF	2367.97	2469.49	2554.57	2757.05	2885.37	2966.91
	48"(1219mm)	E2LP-462-■ ■ FF	2484.59	2590.09	2679.77	2891.93	3026.97	3112.55
	60"(1524mm)	E2LP-562-■ ■ FF	2717.83	2831.29	2930.17	3161.69	3310.17	3403.83
72"(1829mm)	24"(610mm)	E2LP-270-■ ■ FF	\$2086.28	\$ 2184.46	\$ 2257.94	\$ 2441.64	\$ 2553.86	\$2626.86
	30"(762mm)	E2LP-3070-■ ■ FF	2233.39	2335.55	2413.63	2607.01	2725.95	2802.99
	36"(914mm)	E2LP-370-■ ■ FF	2358.98	2465.12	2547.80	2750.86	2876.52	2957.60
	42"(1067mm)	E2LP-4270-■ ■ FF	2484.57	2594.69	2681.97	2894.71	3027.09	3112.21
	48"(1219mm)	E2LP-470-■ ■ FF	2610.16	2724.26	2816.14	3038.56	3177.66	3266.82
	60"(1524mm)	E2LP-570-■ ■ FF	2861.34	2983.40	3084.48	3326.26	3478.80	3576.04
80"(2032mm)	24"(610mm)	E2LP-278-■ ■ FF	\$ 2337.41	\$2444.19	\$ 2519.87	\$ 2713.83	\$2830.11	\$2906.69
	30"(762mm)	E2LP-3078-■ ■ FF	2538.33	2649.09	2729.37	2933.01	3056.01	3136.63
	36"(914mm)	E2LP-378-■ ■ FF	2717.73	2832.47	2917.35	3130.67	3260.39	3345.05
	42"(1067mm)	E2LP-4278-■ ■ FF	2897.13	3015.85	3105.33	3328.33	3464.77	3553.47
	48"(1219mm)	E2LP-478-■ ■ FF	3076.53	3199.23	3293.31	3525.99	3669.15	3761.89
	60"(1524mm)	E2LP-578-■ ■ FF	3435.33	3565.99	3669.27	3921.31	4077.91	4178.73

Monolithic Panel with Full-Height Inserts — Powered UniGroup Too

Actual Height	Width	Number ①	Trim B Fabric					
			A	B	C	E	F	G
32"(813mm)	24"(610mm)	E2LP-230-■ ■ FF	\$ 1553.23	\$ 1608.41	\$ 1670.89	\$ 1803.29	\$ 1895.21	\$ 1950.31
	30"(762mm)	E2LP-3030-■ ■ FF	1634.33	1693.49	1760.57	1902.65	2001.29	2060.43
	36"(914mm)	E2LP-330-■ ■ FF	1715.43	1778.57	1850.25	2002.01	2107.37	2170.55
	42"(1067mm)	E2LP-4230-■ ■ FF	1796.53	1863.65	1939.93	2101.37	2213.45	2280.67
	48"(1219mm)	E2LP-430-■ ■ FF	1877.63	1948.73	2029.61	2200.73	2319.53	2390.79
	60"(1524mm)	E2LP-530-■ ■ FF	2039.83	2118.89	2208.97	2399.45	2531.69	2611.03
40"(1016mm)	24"(610mm)	E2LP-238-■ ■ FF	\$ 1643.82	\$ 1707.60	\$ 1772.28	\$ 1914.94	\$ 2010.92	\$ 2069.60
	30"(762mm)	E2LP-3038-■ ■ FF	1746.44	1814.20	1883.48	2035.82	2138.52	2201.24
	36"(914mm)	E2LP-338-■ ■ FF	1827.54	1899.28	1973.16	2135.18	2244.60	2311.36
	42"(1067mm)	E2LP-4238-■ ■ FF	1908.64	1984.36	2062.84	2234.54	2350.68	2421.48
	48"(1219mm)	E2LP-438-■ ■ FF	1989.74	2069.44	2152.52	2333.90	2456.76	2531.60
	60"(1524mm)	E2LP-538-■ ■ FF	2151.94	2239.60	2331.88	2532.62	2668.92	2751.84
48"(1219mm)	24"(610mm)	E2LP-246-■ ■ FF	\$ 1734.41	\$ 1806.79	\$ 1873.67	\$ 2026.59	\$ 2126.63	\$ 2188.89
	30"(762mm)	E2LP-3046-■ ■ FF	1837.03	1913.39	1984.87	2147.47	2254.23	2320.53
	36"(914mm)	E2LP-346-■ ■ FF	1918.13	1998.47	2074.55	2246.83	2360.31	2430.65
	42"(1067mm)	E2LP-4246-■ ■ FF	1999.23	2083.55	2164.23	2346.19	2466.39	2540.77
	48"(1219mm)	E2LP-446-■ ■ FF	2080.33	2168.63	2253.91	2445.55	2572.47	2650.89
	60"(1524mm)	E2LP-546-■ ■ FF	2242.53	2338.79	2433.27	2644.27	2784.63	2871.13
56"(1422mm)	24"(610mm)	E2LP-254-■ ■ FF	\$ 1825.00	\$ 1905.98	\$ 1975.06	\$ 2138.24	\$ 2242.34	\$ 2308.18
	30"(762mm)	E2LP-3054-■ ■ FF	1927.62	2012.58	2086.26	2259.12	2369.94	2439.82
	36"(914mm)	E2LP-354-■ ■ FF	2008.72	2097.66	2175.94	2358.48	2476.02	2549.94
	42"(1067mm)	E2LP-4254-■ ■ FF	2186.63	2279.55	2362.43	2554.65	2678.91	2756.87
	48"(1219mm)	E2LP-454-■ ■ FF	2300.00	2396.90	2484.38	2686.28	2817.26	2899.26
	60"(1524mm)	E2LP-554-■ ■ FF	2526.74	2631.60	2728.28	2949.54	3093.96	3184.04
64"(1626mm)	24"(610mm)	E2LP-262-■ ■ FF	\$ 2005.59	\$ 2095.17	\$ 2166.45	\$ 2339.89	\$ 2448.05	\$ 2517.47
	30"(762mm)	E2LP-3062-■ ■ FF	2108.21	2201.77	2277.65	2460.77	2575.65	2649.11
	36"(914mm)	E2LP-362-■ ■ FF	2261.05	2358.59	2439.07	2631.87	2753.47	2830.97
	42"(1067mm)	E2LP-4262-■ ■ FF	2378.02	2479.54	2564.62	2767.10	2895.42	2976.96
	48"(1219mm)	E2LP-462-■ ■ FF	2494.99	2600.49	2690.17	2902.33	3037.37	3122.95
	60"(1524mm)	E2LP-562-■ ■ FF	2728.93	2842.39	2941.27	3172.79	3321.27	3414.93
72"(1829mm)	24"(610mm)	E2LP-270-■ ■ FF	\$ 2096.18	\$ 2194.36	\$ 2267.84	\$ 2451.54	\$ 2563.76	\$ 2636.76
	30"(762mm)	E2LP-3070-■ ■ FF	2243.64	2345.80	2423.88	2617.26	2736.20	2813.24
	36"(914mm)	E2LP-370-■ ■ FF	2369.58	2475.72	2558.40	2761.46	2887.12	2968.20
	42"(1067mm)	E2LP-4270-■ ■ FF	2495.52	2605.64	2692.92	2905.66	3038.04	3123.16
	48"(1219mm)	E2LP-470-■ ■ FF	2621.46	2735.56	2827.44	3049.86	3188.96	3278.12
	60"(1524mm)	E2LP-570-■ ■ FF	2873.34	2995.40	3096.48	3338.26	3490.80	3588.04
80"(2032mm)	24"(610mm)	E2LP-278-■ ■ FF	\$ 2348.21	\$ 2454.99	\$ 2530.67	\$ 2724.63	\$ 2840.91	\$ 2917.49
	30"(762mm)	E2LP-3078-■ ■ FF	2549.48	2660.24	2740.52	2944.16	3067.16	3147.78
	36"(914mm)	E2LP-378-■ ■ FF	2729.23	2843.97	2928.85	3142.17	3271.89	3356.55
	42"(1067mm)	E2LP-4278-■ ■ FF	2908.98	3027.70	3117.18	3340.18	3476.62	3565.32
	48"(1219mm)	E2LP-478-■ ■ FF	3088.73	3211.43	3305.51	3538.19	3681.35	3774.09
	60"(1524mm)	E2LP-578-■ ■ FF	3448.23	3578.89	3682.17	3934.21	4090.81	4191.63

Monolithic Panel with Segmented Inserts — No Power

UniGroup Too

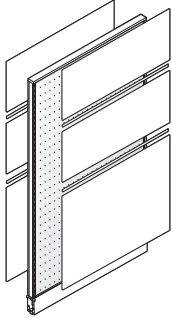

E2SN-B (Non-Powered)
Class AC

Features

- Includes non-powered full-height panel core assembly, segmented panel inserts and trim strips, square top cap with aligner, with or without one-piece base raceway cover, 1.6 hinge kits, side trim rails, leveling glides and carpet gripper. **6** top cap end plugs and base raceway end caps are shipped with each panel. Order additional as necessary.
- Acoustical panel surfaces bonded to compressed fiber board for moderate tackable properties.
- Panel surfaces may have the same fabric on both sides or a different fabric on each side.
- Panel thickness is 2"(51mm).
- Base raceway is 4"(102mm)H.
- Shipped with unassembled inserts, top cap, base raceway cover side trim rails.
- Inserts may easily be changed on installed monolithic panels without components.
- Refer to the Panel Configuration Options chart in Specification Guide for panel and insert heights (nominal vs. actual) and insert configurations.

Specification Tips

- Panels will accept add-on panels up to a combined height of 80"(2032mm). For aesthetic consistency, specify UniGroup Too add-on panels.
- Raceway cover must be separately specified for option -BE (no raceway cover).
- If 90° top cap for four-way and 120° top cap for three-way are not specified, additional top cap end plugs will need to be ordered.
- Additional top cap end plugs and base raceway end caps will need to be specified if finish posts are not ordered.

To Order, Specify:

- 1) Product number, including:

1 Options:

B With Raceway Cover

BE Without Raceway Cover
(deduct **\$98.65** list)

- 2) Fabric/colorway for panel insert side one.
- 3) Fabric/colorway for panel insert side two.
- 4) Trim color raceway cover, glide housings and end caps. Not available in metallic trim colors.
- 5) Trim color for top cap, side trim rails and trim strip(s) for panel insert.

Note: Upcharge for mixed surface grades, refer to the electronic design and specification tools for pricing.

Notes:

- Non-powered panels ship without receptacle ports in the base raceway cover.
- Some building codes may restrict the use of panel heights greater than 69"(1753mm). Consult your local code authority to assure that the furniture layout is compliant.
- For International Power, specify non-powered panels and use Power Logic components. See Specification Guide for more information on Power Logic.

Monolithic Panel with Segmented Inserts — No Power

UniGroup Too

Actual Height	Width	Number ①	Trim A Fabric					
			A	B	C	E	F	G
40"(1016mm)	24"(610mm)	E2SN-238-■ ■ FF	\$ 1246.90	\$ 1317.36	\$ 1389.64	\$ 1548.54	\$ 1655.66	\$ 1721.10
	30"(762mm)	E2SN-3038-■ ■ FF	1393.99	1475.17	1559.65	1744.41	1869.45	1945.69
	36"(914mm)	E2SN-338-■ ■ FF	1519.56	1611.46	1708.14	1918.76	2061.72	2148.76
	42"(1067mm)	E2SN-4238-■ ■ FF	1645.13	1747.75	1856.63	2093.11	2253.99	2351.83
	48"(1219mm)	E2SN-438-■ ■ FF	1770.70	1884.04	2005.12	2267.46	2446.26	2554.90
	60"(1524mm)	E2SN-538-■ ■ FF	2021.84	2156.62	2302.10	2616.16	2830.80	2961.04
48"(1219mm)	24"(610mm)	E2SN-246-■ ■ FF	\$ 1345.55	\$ 1425.93	\$ 1501.93	\$ 1674.35	\$ 1787.77	\$ 1858.13
	30"(762mm)	E2SN-3046-■ ■ FF	1492.64	1583.74	1671.94	1870.22	2001.56	2082.72
	36"(914mm)	E2SN-346-■ ■ FF	1618.21	1720.03	1820.43	2044.57	2193.83	2285.79
	42"(1067mm)	E2SN-4246-■ ■ FF	1743.78	1856.32	1968.92	2218.92	2386.10	2488.86
	48"(1219mm)	E2SN-446-■ ■ FF	1869.35	1992.61	2117.41	2393.27	2578.37	2691.93
	60"(1524mm)	E2SN-546-■ ■ FF	2120.49	2265.19	2414.39	2741.97	2962.91	3098.07
56"(1422mm)	24"(610mm)	E2SN-254-■ ■ FF	\$ 1605.64	\$ 1695.94	\$ 1775.66	\$ 1961.60	\$ 2081.32	\$ 2156.60
	30"(762mm)	E2SN-3054-■ ■ FF	1752.73	1853.75	1945.67	2157.47	2295.11	2381.19
	36"(914mm)	E2SN-354-■ ■ FF	1878.30	1990.04	2094.16	2331.82	2487.38	2584.26
	42"(1067mm)	E2SN-4254-■ ■ FF	2100.68	2223.14	2339.46	2602.98	2776.46	2884.14
	48"(1219mm)	E2SN-454-■ ■ FF	2258.52	2391.70	2520.22	2809.60	3001.00	3119.48
	60"(1524mm)	E2SN-554-■ ■ FF	2574.20	2728.82	2881.74	3222.84	3450.08	3590.16
64"(1626mm)	24"(610mm)	E2SN-262-■ ■ FF	\$ 1794.29	\$ 1894.51	\$ 1977.95	\$ 2177.41	\$ 2303.43	\$ 2383.63
	30"(762mm)	E2SN-3062-■ ■ FF	1941.38	2052.32	2147.96	2373.28	2517.22	2608.22
	36"(914mm)	E2SN-362-■ ■ FF	2296.00	2417.66	2525.50	2776.68	2938.54	3040.34
	42"(1067mm)	E2SN-4262-■ ■ FF	2300.13	2432.51	2552.55	2829.59	3009.37	3121.97
	48"(1219mm)	E2SN-462-■ ■ FF	2461.57	2604.67	2736.91	3039.81	3237.51	3360.91
	60"(1524mm)	E2SN-562-■ ■ FF	2784.45	2948.99	3105.63	3460.25	3693.79	3838.79
72"(1829mm)	24"(610mm)	E2SN-270-■ ■ FF	\$ 1892.94	\$ 2003.08	\$ 2090.24	\$ 2303.22	\$ 2435.54	\$ 2520.66
	30"(762mm)	E2SN-3070-■ ■ FF	2084.87	2205.73	2305.09	2543.93	2694.17	2790.09
	36"(914mm)	E2SN-370-■ ■ FF	2255.28	2386.86	2498.42	2763.12	2931.28	3038.00
	42"(1067mm)	E2SN-4270-■ ■ FF	2425.69	2567.99	2691.75	2982.31	3168.39	3285.91
	48"(1219mm)	E2SN-470-■ ■ FF	2596.10	2749.12	2885.08	3201.50	3405.50	3533.82
	60"(1524mm)	E2SN-570-■ ■ FF	2936.92	3111.38	3271.74	3639.88	3879.72	4029.64
80"(2032mm)	24"(610mm)	E2SN-278-■ ■ FF	\$ 2153.03	\$ 2273.09	\$ 2363.97	\$ 2590.47	\$ 2729.09	\$ 2819.13
	30"(762mm)	E2SN-3078-■ ■ FF	2398.77	2529.55	2632.63	2884.99	3041.53	3142.37
	36"(914mm)	E2SN-378-■ ■ FF	2622.99	2764.49	2879.77	3157.99	3332.45	3444.09
	42"(1067mm)	E2SN-4278-■ ■ FF	2847.21	2999.43	3126.91	3430.99	3623.37	3745.81
	48"(1219mm)	E2SN-478-■ ■ FF	3071.43	3234.37	3374.05	3703.99	3914.29	4047.53
	60"(1524mm)	E2SN-578-■ ■ FF	3519.87	3704.25	3868.33	4249.99	4496.13	4650.97

Monolithic Panel with Segmented Inserts — No Power

UniGroup Too

Actual Height	Width	Number ①	Trim B Fabric					
			A	B	C	E	F	G
40"(1016mm)	24"(610mm)	E2SN-238-■ ■ FF	\$ 1253.20	\$ 1323.66	\$ 1395.94	\$ 1554.84	\$ 1661.96	\$ 1727.40
	30"(762mm)	E2SN-3038-■ ■ FF	1400.64	1481.82	1566.30	1751.06	1876.10	1952.34
	36"(914mm)	E2SN-338-■ ■ FF	1526.56	1618.46	1715.14	1925.76	2068.72	2155.76
	42"(1067mm)	E2SN-4238-■ ■ FF	1652.48	1755.10	1863.98	2100.46	2261.34	2359.18
	48"(1219mm)	E2SN-438-■ ■ FF	1778.40	1891.74	2012.82	2275.16	2453.96	2562.60
	60"(1524mm)	E2SN-538-■ ■ FF	2030.24	2165.02	2310.50	2624.56	2839.20	2969.44
48"(1219mm)	24"(610mm)	E2SN-246-■ ■ FF	\$ 1352.75	\$ 1433.13	\$ 1509.13	\$ 1681.55	\$ 1794.97	\$ 1865.33
	30"(762mm)	E2SN-3046-■ ■ FF	1500.19	1591.29	1679.49	1877.77	2009.11	2090.27
	36"(914mm)	E2SN-346-■ ■ FF	1626.11	1727.93	1828.33	2052.47	2201.73	2293.69
	42"(1067mm)	E2SN-4246-■ ■ FF	1752.03	1864.57	1977.17	2227.17	2394.35	2497.11
	48"(1219mm)	E2SN-446-■ ■ FF	1877.95	2001.21	2126.01	2401.87	2586.97	2700.53
	60"(1524mm)	E2SN-546-■ ■ FF	2129.79	2274.49	2423.69	2751.27	2972.21	3107.37
56"(1422mm)	24"(610mm)	E2SN-254-■ ■ FF	\$ 1613.74	\$ 1704.04	\$ 1783.76	\$ 1969.70	\$ 2089.42	\$ 2164.70
	30"(762mm)	E2SN-3054-■ ■ FF	1761.18	1862.20	1954.12	2165.92	2303.56	2389.64
	36"(914mm)	E2SN-354-■ ■ FF	1887.10	1998.84	2102.96	2340.62	2496.18	2593.06
	42"(1067mm)	E2SN-4254-■ ■ FF	2109.83	2232.29	2348.61	2612.13	2785.61	2893.29
	48"(1219mm)	E2SN-454-■ ■ FF	2268.02	2401.20	2529.72	2819.10	3010.50	3128.98
	60"(1524mm)	E2SN-554-■ ■ FF	2584.40	2739.02	2891.94	3233.04	3460.28	3600.36
64"(1626mm)	24"(610mm)	E2SN-262-■ ■ FF	\$ 1803.29	\$ 1903.51	\$ 1986.95	\$ 2186.41	\$ 2312.43	\$ 2392.63
	30"(762mm)	E2SN-3062-■ ■ FF	1950.73	2061.67	2157.31	2382.63	2526.57	2617.57
	36"(914mm)	E2SN-362-■ ■ FF	2305.70	2427.36	2535.20	2786.38	2948.24	3050.04
	42"(1067mm)	E2SN-4262-■ ■ FF	2310.18	2442.56	2562.60	2839.64	3019.42	3132.02
	48"(1219mm)	E2SN-462-■ ■ FF	2471.97	2615.07	2747.31	3050.21	3247.91	3371.31
	60"(1524mm)	E2SN-562-■ ■ FF	2795.55	2960.09	3116.73	3471.35	3704.89	3849.89
72"(1829mm)	24"(610mm)	E2SN-270-■ ■ FF	\$ 1902.84	\$ 2012.98	\$ 2100.14	\$ 2313.12	\$ 2445.44	\$ 2530.56
	30"(762mm)	E2SN-3070-■ ■ FF	2095.12	2215.98	2315.34	2554.18	2704.42	2800.34
	36"(914mm)	E2SN-370-■ ■ FF	2265.88	2397.46	2509.02	2773.72	2941.88	3048.60
	42"(1067mm)	E2SN-4270-■ ■ FF	2436.64	2578.94	2702.70	2993.26	3179.34	3296.86
	48"(1219mm)	E2SN-470-■ ■ FF	2607.40	2760.42	2896.38	3212.80	3416.80	3545.12
	60"(1524mm)	E2SN-570-■ ■ FF	2948.92	3123.38	3283.74	3651.88	3891.72	4041.64
80"(2032mm)	24"(610mm)	E2SN-278-■ ■ FF	\$ 2163.83	\$ 2283.89	\$ 2374.77	\$ 2601.27	\$ 2739.89	\$ 2829.93
	30"(762mm)	E2SN-3078-■ ■ FF	2409.92	2540.70	2643.78	2896.14	3052.68	3153.52
	36"(914mm)	E2SN-378-■ ■ FF	2634.49	2775.99	2891.27	3169.49	3343.95	3455.59
	42"(1067mm)	E2SN-4278-■ ■ FF	2859.06	3011.28	3138.76	3442.84	3635.22	3757.66
	48"(1219mm)	E2SN-478-■ ■ FF	3083.63	3246.57	3386.25	3716.19	3926.49	4059.73
	60"(1524mm)	E2SN-578-■ ■ FF	3532.77	3717.15	3881.23	4262.89	4509.03	4663.87

Monolithic Panel with Segmented Inserts — Powered UniGroup Too

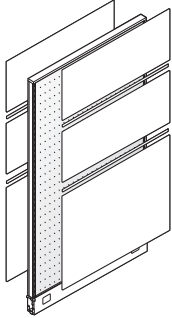

E2SP-B (3-circuit)
Class AC



Features

- Includes powered full-height panel core assembly, segmented panel inserts and trim strips, square top cap with aligner, with or without one-piece base raceway cover, 1.6 hinge kits, side trim rails, leveling glides and carpet gripper; power distribution assembly/flex connector(s). .6 top cap end plugs and base raceway end caps are shipped with each panel. Order additional as necessary.
- Acoustical panel surfaces bonded to compressed fiber board for moderate tackable properties.
- Panel surfaces may have the same fabric on both sides or a different fabric on each side.
- Panel thickness is 2"(51mm).
- Base raceway is 4"(102mm)H.
- Powered raceway with or without raceway cover requires modified catalog number and list price.
- Powered panels are available for countries that utilize 120 volt 60 hertz electrical systems and U.S. configured plugs and outlets.
- Shipped with unassembled inserts, top cap, base raceway cover side trim rails.
- Inserts may easily be changed on installed monolithic panels without components.
- Refer to the Panel Configuration Options chart in Specification Guide for panel and insert heights (nominal vs. actual) and insert configurations.

Specification Tips

- Panels will accept add-on panels up to a combined height of 80"(2032mm). For aesthetic consistency, specify UniGroup Too add-on panels.
- Flex connectors provided for powered monolithic panels accommodate straight in-line, inside 90°, and inside 120° conditions (if applicable).
- Receptacles for powered panels must be specified separately.
- Raceway cover must be separately specified for option -BE or BYE (no raceway cover).
- If 90° top cap for four-way and 120° top cap for three-way are not specified, additional top cap end plugs will need to be ordered.
- Additional top cap end plugs and base raceway end caps will need to be specified if finish posts are not ordered.

To Order, Specify:

1) Product number, including:

1 3-Circuit

B With Raceway Cover

BE Without Raceway Cover
(deduct **\$127.34** list)

BY NYC with Raceway Cover

BYE NYC without Raceway Cover
(deduct **\$127.34** list)

2) Fabric/colorway for panel insert side one.

3) Fabric/colorway for panel insert side two.

4) Trim color raceway cover, glide housings and end caps. Not available in metallic trim colors.

5) Trim color for top cap, side trim rails and trim strip(s) for panel insert.

Note: Upcharge for mixed surface grades, refer to the electronic design and specification tools for pricing.

Notes:

- Powered panels with raceway covers ship with receptacle ports in the base raceway cover. Receptacle ports on the raceway cover measure 2.35"(60mm) top-to-bottom and 2.88"(73mm) side-to-side.
- Powered panels with Power Distribution Assemblies (PDA) but without raceway covers require separately specified base raceway covers for power and communication port locations other than the standard powered base raceway cover.
- New York City (NYC) electrical applications require field installation of PDA.
- New York Port Authority (NYPA) electrical applications require metal raceway covers. To order, specify NYC powered panels without raceway cover and separately specify metal covers through Haworth e-Parts.
- Some building codes may restrict the use of panel heights greater than 69"(1753mm). Consult your local code authority to assure that the furniture layout is compliant.
- For International Power, specify non-powered panels and use Power Logic components. See Specification Guide for more information on Power Logic.
- For Chicago power, specify non-powered panels without a base raceway cover and separately specify Chicago power retrofit kit.

Monolithic Panel with Segmented Inserts — Powered UniGroup Too

Actual Height	Width	Number ①	Trim A Fabric					
			A	B	C	E	F	G
40"(1016mm)	24"(610mm)	E2SP-238-■ ■ FF	\$ 1682.38	\$ 1752.84	\$ 1825.12	\$ 1984.02	\$ 2091.14	\$ 2156.58
	30"(762mm)	E2SP-3038-■ ■ FF	1829.47	1910.65	1995.13	2179.89	2304.93	2381.17
	36"(914mm)	E2SP-338-■ ■ FF	1955.04	2046.94	2143.62	2354.24	2497.20	2584.24
	42"(1067mm)	E2SP-4238-■ ■ FF	2080.61	2183.23	2292.11	2528.59	2689.47	2787.31
	48"(1219mm)	E2SP-438-■ ■ FF	2206.18	2319.52	2440.60	2702.94	2881.74	2990.38
	60"(1524mm)	E2SP-538-■ ■ FF	2457.32	2592.10	2737.58	3051.64	3266.28	3396.52
48"(1219mm)	24"(610mm)	E2SP-246-■ ■ FF	\$ 1781.03	\$ 1861.41	\$ 1937.41	\$ 2109.83	\$ 2223.25	\$ 2293.61
	30"(762mm)	E2SP-3046-■ ■ FF	1928.12	2019.22	2107.42	2305.70	2437.04	2518.20
	36"(914mm)	E2SP-346-■ ■ FF	2053.69	2155.51	2255.91	2480.05	2629.31	2721.27
	42"(1067mm)	E2SP-4246-■ ■ FF	2179.26	2291.80	2404.40	2654.40	2821.58	2924.34
	48"(1219mm)	E2SP-446-■ ■ FF	2304.83	2428.09	2552.89	2828.75	3013.85	3127.41
	60"(1524mm)	E2SP-546-■ ■ FF	2555.97	2700.67	2849.87	3177.45	3398.39	3533.55
56"(1422mm)	24"(610mm)	E2SP-254-■ ■ FF	\$ 2041.12	\$ 2131.42	\$ 2211.14	\$ 2397.08	\$ 2516.80	\$ 2592.08
	30"(762mm)	E2SP-3054-■ ■ FF	2188.21	2289.23	2381.15	2592.95	2730.59	2816.67
	36"(914mm)	E2SP-354-■ ■ FF	2313.78	2425.52	2529.64	2767.30	2922.86	3019.74
	42"(1067mm)	E2SP-4254-■ ■ FF	2536.16	2658.62	2774.94	3038.46	3211.94	3319.62
	48"(1219mm)	E2SP-454-■ ■ FF	2694.00	2827.18	2955.70	3245.08	3436.48	3554.96
	60"(1524mm)	E2SP-554-■ ■ FF	3009.68	3164.30	3317.22	3658.32	3885.56	4025.64
64"(1626mm)	24"(610mm)	E2SP-262-■ ■ FF	\$ 2229.77	\$ 2329.99	\$ 2413.43	\$ 2612.89	\$ 2738.91	\$ 2819.11
	30"(762mm)	E2SP-3062-■ ■ FF	2376.86	2487.80	2583.44	2808.76	2952.70	3043.70
	36"(914mm)	E2SP-362-■ ■ FF	2731.48	2853.14	2960.98	3212.16	3374.02	3475.82
	42"(1067mm)	E2SP-4262-■ ■ FF	2735.61	2867.99	2988.03	3265.07	3444.85	3557.45
	48"(1219mm)	E2SP-462-■ ■ FF	2897.05	3040.15	3172.39	3475.29	3672.99	3796.39
	60"(1524mm)	E2SP-562-■ ■ FF	3219.93	3384.47	3541.11	3895.73	4129.27	4274.27
72"(1829mm)	24"(610mm)	E2SP-270-■ ■ FF	\$ 2328.42	\$ 2438.56	\$ 2525.72	\$ 2738.70	\$ 2871.02	\$ 2956.14
	30"(762mm)	E2SP-3070-■ ■ FF	2520.35	2641.21	2740.57	2979.41	3129.65	3225.57
	36"(914mm)	E2SP-370-■ ■ FF	2690.76	2822.34	2933.90	3198.60	3366.76	3473.48
	42"(1067mm)	E2SP-4270-■ ■ FF	2861.17	3003.47	3127.23	3417.79	3603.87	3721.39
	48"(1219mm)	E2SP-470-■ ■ FF	3031.58	3184.60	3320.56	3636.98	3840.98	3969.30
	60"(1524mm)	E2SP-570-■ ■ FF	3372.40	3546.86	3707.22	4075.36	4315.20	4465.12
80"(2032mm)	24"(610mm)	E2SP-278-■ ■ FF	\$ 2588.51	\$ 2708.57	\$ 2799.45	\$ 3025.95	\$ 3164.57	\$ 3254.61
	30"(762mm)	E2SP-3078-■ ■ FF	2834.25	2965.03	3068.11	3320.47	3477.01	3577.85
	36"(914mm)	E2SP-378-■ ■ FF	3058.47	3199.97	3315.25	3593.47	3767.93	3879.57
	42"(1067mm)	E2SP-4278-■ ■ FF	3282.69	3434.91	3562.39	3866.47	4058.85	4181.29
	48"(1219mm)	E2SP-478-■ ■ FF	3506.91	3669.85	3809.53	4139.47	4349.77	4483.01
	60"(1524mm)	E2SP-578-■ ■ FF	3955.35	4139.73	4303.81	4685.47	4931.61	5086.45

Monolithic Panel with Segmented Inserts — Powered UniGroup Too

Actual Height	Width	Number ①	Trim B Fabric					
			A	B	C	E	F	G
40"(1016mm)	24"(610mm)	E2SP-238-■ ■ FF	\$ 1688.68	\$ 1759.14	\$ 1831.42	\$ 1990.32	\$ 2097.44	\$ 2162.88
	30"(762mm)	E2SP-3038-■ ■ FF	1836.12	1917.30	2001.78	2186.54	2311.58	2387.82
	36"(914mm)	E2SP-338-■ ■ FF	1962.04	2053.94	2150.62	2361.24	2504.20	2591.24
	42"(1067mm)	E2SP-4238-■ ■ FF	2087.96	2190.58	2299.46	2535.94	2696.82	2794.66
	48"(1219mm)	E2SP-438-■ ■ FF	2213.88	2327.22	2448.30	2710.64	2889.44	2998.08
	60"(1524mm)	E2SP-538-■ ■ FF	2465.72	2600.50	2745.98	3060.04	3274.68	3404.92
48"(1219mm)	24"(610mm)	E2SP-246-■ ■ FF	\$ 1788.23	\$ 1868.61	\$ 1944.61	\$ 2117.03	\$ 2230.45	\$ 2300.81
	30"(762mm)	E2SP-3046-■ ■ FF	1935.67	2026.77	2114.97	2313.25	2444.59	2525.75
	36"(914mm)	E2SP-346-■ ■ FF	2061.59	2163.41	2263.81	2487.95	2637.21	2729.17
	42"(1067mm)	E2SP-4246-■ ■ FF	2187.51	2300.05	2412.65	2662.65	2829.83	2932.59
	48"(1219mm)	E2SP-446-■ ■ FF	2313.43	2436.69	2561.49	2837.35	3022.45	3136.01
	60"(1524mm)	E2SP-546-■ ■ FF	2565.27	2709.97	2859.17	3186.75	3407.69	3542.85
56"(1422mm)	24"(610mm)	E2SP-254-■ ■ FF	\$ 2049.22	\$ 2139.52	\$ 2219.24	\$ 2405.18	\$ 2524.90	\$ 2600.18
	30"(762mm)	E2SP-3054-■ ■ FF	2196.66	2297.68	2389.60	2601.40	2739.04	2825.12
	36"(914mm)	E2SP-354-■ ■ FF	2322.58	2434.32	2538.44	2776.10	2931.66	3028.54
	42"(1067mm)	E2SP-4254-■ ■ FF	2545.31	2667.77	2784.09	3047.61	3221.09	3328.77
	48"(1219mm)	E2SP-454-■ ■ FF	2703.50	2836.68	2965.20	3254.58	3445.98	3564.46
	60"(1524mm)	E2SP-554-■ ■ FF	3019.88	3174.50	3327.42	3668.52	3895.76	4035.84
64"(1626mm)	24"(610mm)	E2SP-262-■ ■ FF	\$ 2238.77	\$ 2338.99	\$ 2422.43	\$ 2621.89	\$ 2747.91	\$ 2828.11
	30"(762mm)	E2SP-3062-■ ■ FF	2386.21	2497.15	2592.79	2818.11	2962.05	3053.05
	36"(914mm)	E2SP-362-■ ■ FF	2741.18	2862.84	2970.68	3221.86	3383.72	3485.52
	42"(1067mm)	E2SP-4262-■ ■ FF	2745.66	2878.04	2998.08	3275.12	3454.90	3567.50
	48"(1219mm)	E2SP-462-■ ■ FF	2907.45	3050.55	3182.79	3485.69	3683.39	3806.79
	60"(1524mm)	E2SP-562-■ ■ FF	3231.03	3395.57	3552.21	3906.83	4140.37	4285.37
72"(1829mm)	24"(610mm)	E2SP-270-■ ■ FF	\$ 2338.32	\$ 2448.46	\$ 2535.62	\$ 2748.60	\$ 2880.92	\$ 2966.04
	30"(762mm)	E2SP-3070-■ ■ FF	2530.60	2651.46	2750.82	2989.66	3139.90	3235.82
	36"(914mm)	E2SP-370-■ ■ FF	2701.36	2832.94	2944.50	3209.20	3377.36	3484.08
	42"(1067mm)	E2SP-4270-■ ■ FF	2872.12	3014.42	3138.18	3428.74	3614.82	3732.34
	48"(1219mm)	E2SP-470-■ ■ FF	3042.88	3195.90	3331.86	3648.28	3852.28	3980.60
	60"(1524mm)	E2SP-570-■ ■ FF	3384.40	3558.86	3719.22	4087.36	4327.20	4477.12
80"(2032mm)	24"(610mm)	E2SP-278-■ ■ FF	\$ 2599.31	\$ 2719.37	\$ 2810.25	\$ 3036.75	\$ 3175.37	\$ 3265.41
	30"(762mm)	E2SP-3078-■ ■ FF	2845.40	2976.18	3079.26	3331.62	3488.16	3589.00
	36"(914mm)	E2SP-378-■ ■ FF	3069.97	3211.47	3326.75	3604.97	3779.43	3891.07
	42"(1067mm)	E2SP-4278-■ ■ FF	3294.54	3446.76	3574.24	3878.32	4070.70	4193.14
	48"(1219mm)	E2SP-478-■ ■ FF	3519.11	3682.05	3821.73	4151.67	4361.97	4495.21
	60"(1524mm)	E2SP-578-■ ■ FF	3968.25	4152.63	4316.71	4698.37	4944.51	5099.35

Monolithic Panel Core without Insert(s) — No Power

UniGroup Too



E2BN-B (Non-Powered)
Class AC

Features

- Includes non-powered panel core assembly, square top cap with aligner, with or without one-piece base raceway cover, 1.6 hinge kits, side trim rails, leveling glides and carpet gripper. .6 top cap end plugs and base raceway end caps are shipped with each panel. Order additional as necessary.
- **For use with separately specified inserts.**
- Panel thickness is 2" (51mm).
- Base raceway is 4" (102mm)H.
- Shipped with unassembled top cap, base raceway cover and side trim rails.

Specification Tips

- Panels will accept add-on panels up to a combined height of 80" (2032mm). For aesthetic consistency, specify UniGroup Too add-on panels.
- Raceway cover must be separately specified for option -BE (no raceway cover).
- If 90° top cap for four-way and 120° top cap for three-way are not specified, additional top cap end plugs will need to be ordered.
- Additional top cap end plugs and base raceway end caps will need to be specified if finish posts are not ordered.

To Order, Specify:

- 1) Product number, including:

① Options:

B With Raceway Cover

BE Without Raceway Cover
(deduct **\$98.65** list)

- 2) Trim color raceway cover, glide housings and end caps. Not available in metallic trim colors.
- 3) Trim color for top cap and side trim rails.

Note: Upcharge for mixed surface grades, refer to the electronic design and specification tools for pricing.

Notes:

- Non-powered panels ship without receptacle ports in the base raceway cover.
- Some building codes may restrict the use of panel heights greater than 69" (1753mm). Consult your local code authority to assure that the furniture layout is compliant.
- For International Power, specify non-powered panels and use Power Logic components. See Specification Guide for more information on Power Logic.
- For Chicago power, specify non-powered panels without a base raceway cover and separately specify Chicago power retrofit kit.

Monolithic Panel Core without Insert(s) — No Power

UniGroup Too

Actual Height	Width	Number ①	Trim	
			A	B
32"(813mm)	24"(610mm)	E2BN-230-■ ■	\$ 744.67	\$ 750.07
	30"(762mm)	E2BN-3030-■ ■ ■	798.48	804.23
	36"(914mm)	E2BN-330-■ ■	852.29	858.39
	42"(1067mm)	E2BN-4230-■ ■ ■	906.10	912.55
	48"(1219mm)	E2BN-430-■ ■	959.91	966.71
	60"(1524mm)	E2BN-530-■ ■	1067.53	1075.03
40"(1016mm)	24"(610mm)	E2BN-238-■ ■	\$ 776.94	\$ 783.24
	30"(762mm)	E2BN-3038-■ ■ ■	852.27	858.92
	36"(914mm)	E2BN-338-■ ■	906.08	913.08
	42"(1067mm)	E2BN-4238-■ ■ ■	959.89	967.24
	48"(1219mm)	E2BN-438-■ ■	1013.70	1021.40
	60"(1524mm)	E2BN-538-■ ■	1121.32	1129.72
48"(1219mm)	24"(610mm)	E2BN-246-■ ■	\$ 809.21	\$ 816.41
	30"(762mm)	E2BN-3046-■ ■ ■	884.54	892.09
	36"(914mm)	E2BN-346-■ ■	938.35	946.25
	42"(1067mm)	E2BN-4246-■ ■ ■	992.16	1000.41
	48"(1219mm)	E2BN-446-■ ■	1045.97	1054.57
	60"(1524mm)	E2BN-546-■ ■	1153.59	1162.89
56"(1422mm)	24"(610mm)	E2BN-254-■ ■	\$ 841.48	\$ 849.58
	30"(762mm)	E2BN-3054-■ ■ ■	916.81	925.26
	36"(914mm)	E2BN-354-■ ■	970.62	979.42
	42"(1067mm)	E2BN-4254-■ ■ ■	1024.43	1033.58
	48"(1219mm)	E2BN-454-■ ■	1078.24	1087.74
	60"(1524mm)	E2BN-554-■ ■	1185.86	1196.06
64"(1626mm)	24"(610mm)	E2BN-262-■ ■	\$ 963.75	\$ 972.75
	30"(762mm)	E2BN-3062-■ ■ ■	1039.08	1048.43
	36"(914mm)	E2BN-362-■ ■	1092.89	1102.59
	42"(1067mm)	E2BN-4262-■ ■ ■	1146.70	1156.75
	48"(1219mm)	E2BN-462-■ ■	1200.51	1210.91
	60"(1524mm)	E2BN-562-■ ■	1308.13	1319.23
72"(1829mm)	24"(610mm)	E2BN-270-■ ■	\$ 996.02	\$1005.92
	30"(762mm)	E2BN-3070-■ ■ ■	1071.35	1081.60
	36"(914mm)	E2BN-370-■ ■	1125.16	1135.76
	42"(1067mm)	E2BN-4270-■ ■ ■	1178.97	1189.92
	48"(1219mm)	E2BN-470-■ ■	1232.78	1244.08
	60"(1524mm)	E2BN-570-■ ■	1340.40	1352.40
80"(2032mm)	24"(610mm)	E2BN-278-■ ■	\$ 1189.73	\$1200.53
	30"(762mm)	E2BN-3078-■ ■ ■	1293.76	1304.91
	36"(914mm)	E2BN-378-■ ■	1376.27	1387.77
	42"(1067mm)	E2BN-4278-■ ■ ■	1458.78	1470.63
	48"(1219mm)	E2BN-478-■ ■	1541.29	1553.49
	60"(1524mm)	E2BN-578-■ ■	1706.31	1719.21

Monolithic Panel Core without Insert(s) — Powered UniGroup Too



E2BP-B (3-circuit)
Class AC



Features

- Includes powered panel core assembly, square top cap with aligner, with or without one-piece base raceway cover, 1.6 hinge kits, side trim rails, leveling glides and carpet gripper; power distribution assembly/flex connector(s). .6 top cap end plugs and base raceway end caps are shipped with each panel. Order additional as necessary.
- **For use with separately specified inserts.**
- Panel thickness is 2"(51mm).
- Base raceway is 4"(102mm)H.
- Powered raceway with or without raceway cover requires modified catalog number and list price.
- Powered panels are available for countries that utilize 120 volt 60 hertz electrical systems and U.S. configured plugs and outlets.
- Shipped with unassembled top cap, base raceway cover and side trim rails.

Specification Tips

- Panels will accept add-on panels up to a combined height of 80"(2032mm). For aesthetic consistency, specify UniGroup Too add-on panels.
- Flex connectors provided for powered monolithic panels accommodate straight in-line, inside 90°, and inside 120° conditions (if applicable).
- Receptacles for powered panels must be specified separately.
- Raceway cover must be separately specified for option -BE or BYE (no raceway cover).
- If 90° top cap for four-way and 120° top cap for three-way are not specified, additional top cap end plugs will need to be ordered.
- Additional top cap end plugs and base raceway end caps will need to be specified if finish posts are not ordered.

To Order, Specify:

1) Product number, including:

1 3-Circuit

B With Raceway Cover

BE Without Raceway Cover
(deduct **\$127.34** list)

BY NYC with Raceway Cover

BYE NYC without Raceway Cover
(deduct **\$127.34** list)

- 2) Trim color raceway cover, glide housings and end caps. Not available in metallic trim colors.
- 3) Trim color for top cap and side trim rails.

Note: Upcharge for mixed surface grades, refer to the electronic design and specification tools for pricing.

Notes:

- Powered panels with raceway covers ship with receptacle ports in the base raceway cover. Receptacle ports on the raceway cover measure 2.35"(60mm) top-to-bottom and 2.88"(73mm) side-to-side.
- Powered panels with Power Distribution Assemblies (PDA) but without raceway covers require separately specified base raceway covers for power and communication port locations other than the standard powered base raceway cover.
- New York City (NYC) electrical applications require field installation of PDA.
- New York Port Authority (NYPA) electrical applications require metal raceway covers. To order, specify NYC powered panels without raceway cover and separately specify metal covers through Haworth e-Parts.
- Some building codes may restrict the use of panel heights greater than 69"(1753mm). Consult your local code authority to assure that the furniture layout is compliant.
- For International Power, specify non-powered panels and use Power Logic components. See Specification Guide for more information on Power Logic.
- For Chicago power, specify non-powered panels without a base raceway cover and separately specify Chicago power retrofit kit.

Monolithic Panel Core without Insert(s) — Powered UniGroup Too

Actual Height	Width	Number ①	Trim	
			A	B
32"(813mm)	24"(610mm)	E2BP-230-■ ■	\$ 1180.15	\$ 1185.55
	30"(762mm)	E2BP-3030-■ ■	1233.96	1239.71
	36"(914mm)	E2BP-330-■ ■	1287.77	1293.87
	42"(1067mm)	E2BP-4230-■ ■	1341.58	1348.03
	48"(1219mm)	E2BP-430-■ ■	1395.39	1402.19
	60"(1524mm)	E2BP-530-■ ■	1503.01	1510.51
40"(1016mm)	24"(610mm)	E2BP-238-■ ■	\$ 1212.42	\$ 1218.72
	30"(762mm)	E2BP-3038-■ ■	1287.75	1294.40
	36"(914mm)	E2BP-338-■ ■	1341.56	1348.56
	42"(1067mm)	E2BP-4238-■ ■	1395.37	1402.72
	48"(1219mm)	E2BP-438-■ ■	1449.18	1456.88
	60"(1524mm)	E2BP-538-■ ■	1556.80	1565.20
48"(1219mm)	24"(610mm)	E2BP-246-■ ■	\$1244.69	\$ 1251.89
	30"(762mm)	E2BP-3046-■ ■	1320.02	1327.57
	36"(914mm)	E2BP-346-■ ■	1373.83	1381.73
	42"(1067mm)	E2BP-4246-■ ■	1427.64	1435.89
	48"(1219mm)	E2BP-446-■ ■	1481.45	1490.05
	60"(1524mm)	E2BP-546-■ ■	1589.07	1598.37
56"(1422mm)	24"(610mm)	E2BP-254-■ ■	\$ 1276.96	\$ 1285.06
	30"(762mm)	E2BP-3054-■ ■	1352.29	1360.74
	36"(914mm)	E2BP-354-■ ■	1406.10	1414.90
	42"(1067mm)	E2BP-4254-■ ■	1459.91	1469.06
	48"(1219mm)	E2BP-454-■ ■	1513.72	1523.22
	60"(1524mm)	E2BP-554-■ ■	1621.34	1631.54
64"(1626mm)	24"(610mm)	E2BP-262-■ ■	\$1399.23	\$1408.23
	30"(762mm)	E2BP-3062-■ ■	1474.56	1483.91
	36"(914mm)	E2BP-362-■ ■	1528.37	1538.07
	42"(1067mm)	E2BP-4262-■ ■	1582.18	1592.23
	48"(1219mm)	E2BP-462-■ ■	1635.99	1646.39
	60"(1524mm)	E2BP-562-■ ■	1743.61	1754.71
72"(1829mm)	24"(610mm)	E2BP-270-■ ■	\$ 1431.50	\$ 1441.40
	30"(762mm)	E2BP-3070-■ ■	1506.83	1517.08
	36"(914mm)	E2BP-370-■ ■	1560.64	1571.24
	42"(1067mm)	E2BP-4270-■ ■	1614.45	1625.40
	48"(1219mm)	E2BP-470-■ ■	1668.26	1679.56
	60"(1524mm)	E2BP-570-■ ■	1775.88	1787.88
80"(2032mm)	24"(610mm)	E2BP-278-■ ■	\$1625.21	\$1636.01
	30"(762mm)	E2BP-3078-■ ■	1729.24	1740.39
	36"(914mm)	E2BP-378-■ ■	1811.75	1823.25
	42"(1067mm)	E2BP-4278-■ ■	1894.26	1906.11
	48"(1219mm)	E2BP-478-■ ■	1976.77	1988.97
	60"(1524mm)	E2BP-578-■ ■	2141.79	2154.69

Glazed Monolithic Panel — No Power

UniGroup Too

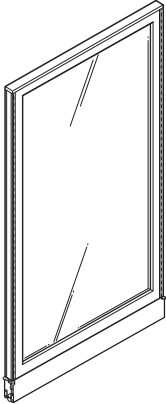

E2GN-B (Non-Powered)
Class AC

Features

- Includes non-powered panel assembly, square top cap with aligner, with or without one-piece base raceway cover, 1.6 hinge kits, side trim rails, leveling glides and carpet gripper. .6 top cap end plugs and base raceway end caps are shipped with each panel. Order additional as necessary.
- Includes 0.25"(6mm) thick clear tempered safety glass or frosted acrylic.
- Panel thickness is 2"(51mm).
- Base raceway is 4"(102mm)H.
- Does not accept top feed modules.
- Shipped with unassembled top cap, base raceway cover and side trim rails.

Specification Tips

- Panels will accept glazed add-on panels up to a combined height of 80"(2032mm). For aesthetic consistency, specify UniGroup Too add-on panels.
- Raceway cover must be separately specified for option -BE (no raceway cover).
- If 90° top cap for four-way and 120° top cap for three-way are not specified, additional top cap end plugs will need to be ordered.
- Additional top cap end plugs and base raceway end caps will need to be specified if finish posts are not ordered.

To Order, Specify:

1) Product number, including:

1 Options:

B With Raceway Cover

BE Without Raceway Cover
(deduct **\$79.48** list)

2) Glazing finish color.

3) Trim color raceway cover. Not available in metallic trim colors.

4) Trim color for frame, top cap and side trim rails.

Note: Upcharge for mixed surface grades, refer to the electronic design and specification tools for pricing.

Notes:

- Non-powered panels ship without receptacle ports in the base raceway cover.
- Some building codes may restrict the use of panel heights greater than 69"(1753mm). Consult your local code authority to assure that the furniture layout is compliant.
- For International Power, specify non-powered panels and use Power Logic components. See Specification Guide for more information on Power Logic.
- For Chicago power, specify non-powered panels without a base raceway cover and separately specify Chicago power retrofit kit.

Glazed Monolithic Panel — No Power

UniGroup Too

Actual Height	Width	Number ⓘ	Clear Trim		Frosted Trim	
			A	B	A	B
64"(1626mm)	24"(610mm)	E2GN-262-■ ■	\$ 2292.15	\$ 2345.55	\$ 2710.47	\$ 2763.87
	30"(762mm)	E2GN-3062-■ ■	2542.95	2598.40	2961.27	3016.72
	36"(914mm)	E2GN-362-■ ■	2772.85	2830.35	3418.03	3475.53
	42"(1067mm)	E2GN-4262-■ ■	3002.75	3062.30	3647.93	3707.48
	48"(1219mm)	E2GN-462-■ ■	3253.55	3315.15	3898.73	3960.33
	60"(1524mm)	E2GN-562-■ ■	3713.35	3779.05	4358.53	4424.23
72"(1829mm)	24"(610mm)	E2GN-270-■ ■	\$ 2628.78	\$ 2690.40	\$ 3047.10	\$ 3108.72
	30"(762mm)	E2GN-3070-■ ■	2879.58	2943.25	3297.90	3361.57
	36"(914mm)	E2GN-370-■ ■	3151.28	3217.00	3796.46	3862.18
	42"(1067mm)	E2GN-4270-■ ■	3422.98	3490.75	4068.16	4135.93
	48"(1219mm)	E2GN-470-■ ■	3673.78	3743.60	4318.96	4388.78
	60"(1524mm)	E2GN-570-■ ■	4217.18	4291.10	4862.36	4936.28
80"(2032mm)	24"(610mm)	E2GN-278-■ ■	\$ 2944.51	\$ 3022.57	\$ 3362.83	\$ 3440.89
	30"(762mm)	E2GN-3078-■ ■	3237.11	3317.22	3655.43	3735.54
	36"(914mm)	E2GN-378-■ ■	3529.71	3611.87	4174.89	4257.05
	42"(1067mm)	E2GN-4278-■ ■	3822.31	3906.52	4467.49	4551.70
	48"(1219mm)	E2GN-478-■ ■	4114.91	4201.17	4760.09	4846.35
	60"(1524mm)	E2GN-578-■ ■	4700.11	4790.47	5345.29	5435.65

Glazed Monolithic Panel — Powered

UniGroup Too

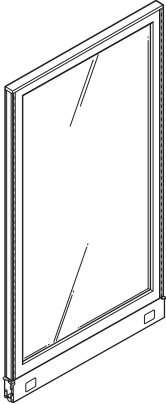

E2GP-B (3-circuit)
Class AC



Features

- Includes powered panel assembly, square top cap with aligner, with or without one-piece base raceway cover, 1.6 hinge kits, side trim rails, leveling glides and carpet gripper; power distribution assembly/flex connector(s). .6 top cap end plugs and base raceway end caps are shipped with each panel. Order additional as necessary.
- Includes 0.25”(6mm) thick clear tempered safety glass or frosted acrylic.
- Panel thickness is 2”(51mm).
- Base raceway is 4”(102mm)H.
- Powered raceway with or without raceway cover requires modified catalog number and list price.
- Powered panels are available for countries that utilize 120 volt 60 hertz electrical systems and U.S. configured plugs and outlets.
- Does not accept top feed modules.
- Shipped with unassembled top cap, base raceway cover and side trim rails.

Specification Tips

- Panels will accept glazed add-on panels up to a combined height of 80”(2032mm). For aesthetic consistency, specify UniGroup Too add-on panels.
- Flex connectors provided for powered monolithic panels accommodate straight in-line, inside 90°, and inside 120° conditions (if applicable).
- Receptacles for powered panels must be specified separately.
- Raceway cover must be separately specified for option -BE or BYE (no raceway cover).
- If 90° top cap for four-way and 120° top cap for three-way are not specified, additional top cap end plugs will need to be ordered.
- Additional top cap end plugs and base raceway end caps will need to be specified if finish posts are not ordered.

To Order, Specify:

1) Product number, including:

1 3-Circuit

B With Raceway Cover

BE Without Raceway Cover
(deduct **\$152.20** list)

BY NYC with Raceway Cover

BYE NYC without Raceway Cover
(deduct **\$152.20** list)

2) Glazing finish color.

3) Trim color raceway cover. Not available in metallic trim colors.

4) Trim color for frame, top cap and side trim rails.

Note: Upcharge for mixed surface grades, refer to the electronic design and specification tools for pricing.

Notes:

- Powered panels with raceway covers ship with receptacle ports in the base raceway cover. Receptacle ports on the raceway cover measure 2.35”(60mm) top-to-bottom and 2.88”(73mm) side-to-side.
- Powered panels with Power Distribution Assemblies (PDA) but without raceway covers require separately specified base raceway covers for power and communication port locations other than the standard powered base raceway cover.
- New York City (NYC) electrical applications require field installation of PDA.
- New York Port Authority (NYPA) electrical applications require metal raceway covers. To order, specify NYC powered panels without raceway cover and separately specify metal covers through Haworth e-Parts.
- Some building codes may restrict the use of panel heights greater than 69”(1753mm). Consult your local code authority to assure that the furniture layout is compliant.
- For International Power, specify non-powered panels and use Power Logic components. See Specification Guide for more information on Power Logic.
- For Chicago power, specify non-powered panels without a base raceway cover and separately specify Chicago power retrofit kit.

Glazed Monolithic Panel — Powered

UniGroup Too

Actual Height	Width	Number ⓘ	Clear Trim		Frosted Trim	
			A	B	A	B
64"(1626mm)	24"(610mm)	E2GP-262-■ ■	\$2843.66	\$ 2897.06	\$ 3261.98	\$ 3315.38
	30"(762mm)	E2GP-3062-■ ■	3094.46	3149.91	3512.78	3568.23
	36"(914mm)	E2GP-362-■ ■	3324.36	3381.86	3969.54	4027.04
	42"(1067mm)	E2GP-4262-■ ■	3554.26	3613.81	4199.44	4258.99
	48"(1219mm)	E2GP-462-■ ■	3805.06	3866.66	4450.24	4511.84
	60"(1524mm)	E2GP-562-■ ■	4264.86	4330.56	4910.04	4975.74
72"(1829mm)	24"(610mm)	E2GP-270-■ ■	\$ 3180.29	\$ 3241.91	\$3598.61	\$3660.23
	30"(762mm)	E2GP-3070-■ ■	3431.09	3494.76	3849.41	3913.08
	36"(914mm)	E2GP-370-■ ■	3702.79	3768.51	4347.97	4413.69
	42"(1067mm)	E2GP-4270-■ ■	3974.49	4042.26	4619.67	4687.44
	48"(1219mm)	E2GP-470-■ ■	4225.29	4295.11	4870.47	4940.29
	60"(1524mm)	E2GP-570-■ ■	4768.69	4842.61	5413.87	5487.79
80"(2032mm)	24"(610mm)	E2GP-278-■ ■	\$3496.02	\$ 3574.08	\$ 3914.34	\$3992.40
	30"(762mm)	E2GP-3078-■ ■	3788.62	3868.73	4206.94	4287.05
	36"(914mm)	E2GP-378-■ ■	4081.22	4163.38	4726.40	4808.56
	42"(1067mm)	E2GP-4278-■ ■	4373.82	4458.03	5019.00	5103.21
	48"(1219mm)	E2GP-478-■ ■	4666.42	4752.68	5311.60	5397.86
	60"(1524mm)	E2GP-578-■ ■	5251.62	5341.98	5896.80	5987.16

Base Insert

UniGroup Too

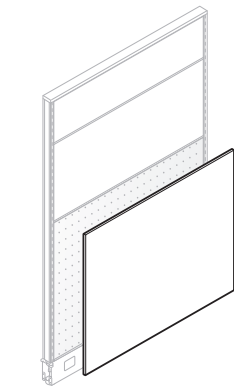
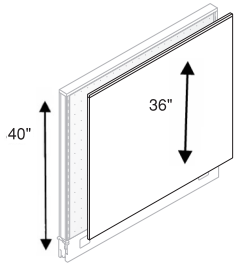

E2JF
Class AC

Feature

- Includes one base insert.

Specification Tips

- Only for use at base with monolithic core panel, separately specified.
- May be used with upper inserts and appropriate height panel core.
- Base and/or upper insert combinations may vary per panel side.
- Only one base insert per side is allowed.

To Order, Specify:

- 1) Product number.
- 2) Fabric/colorway.

Installed Height	Insert Height	Width	Number	Fabric						
				A	B	C	E	F	G	
16"(406mm)	12"(305mm)	24"(610mm)	E2JF-214	\$ 109.63	\$ 127.04	\$ 144.96	\$ 185.16	\$ 212.64	\$ 229.37	
		30"(762mm)	E2JF-3014	122.67	142.24	162.24	207.24	238.08	256.81	
		36"(914mm)	E2JF-314	137.34	159.34	181.68	232.08	266.70	287.68	
		42"(1067mm)	E2JF-4214	150.38	174.54	198.96	254.16	292.14	315.12	
		48"(1219mm)	E2JF-414	165.05	191.64	218.40	279.00	320.76	345.99	
32"(813mm)	28"(711mm)	24"(610mm)	E2JF-230	\$ 171.57	\$ 199.24	\$ 227.04	\$ 290.04	\$ 333.48	\$ 359.71	
		30"(762mm)	E2JF-3030	200.91	233.44	265.92	339.72	390.72	421.45	
		36"(914mm)	E2JF-330	230.25	267.64	304.80	389.40	447.96	483.19	
		42"(1067mm)	E2JF-4230	259.59	301.84	343.68	439.08	505.20	544.93	
		48"(1219mm)	E2JF-430	288.93	336.04	382.56	488.76	562.44	606.67	
40"(1016mm)	36"(914mm)	24"(610mm)	E2JF-238	\$204.17	\$ 237.24	\$ 270.24	\$ 345.24	\$ 397.08	\$ 428.31	
		30"(762mm)	E2JF-3038	240.03	279.04	317.76	405.96	467.04	503.77	
		36"(914mm)	E2JF-338	277.52	322.74	367.44	469.44	540.18	582.66	
		42"(1067mm)	E2JF-4238	315.01	366.44	417.12	532.92	613.32	661.55	
		48"(1219mm)	E2JF-438	352.50	410.14	466.80	596.40	686.46	740.44	
48"(1219mm)	44"(1118mm)	24"(610mm)	E2JF-246	\$ 235.14	\$ 273.34	\$ 311.28	\$ 397.68	\$ 457.50	\$ 493.48	
		30"(762mm)	E2JF-3046	279.15	324.64	369.60	472.20	543.36	586.09	
		36"(914mm)	E2JF-346	324.79	377.84	430.08	549.48	632.40	682.13	
		42"(1067mm)	E2JF-4246	370.43	431.04	490.56	626.76	721.44	778.17	
		48"(1219mm)	E2JF-446	414.44	482.34	548.88	701.28	807.30	870.78	
56"(1422mm)	52"(1321mm)	24"(610mm)	E2JF-254	\$266.11	\$309.44	\$ 352.32	\$ 450.12	\$ 517.92	\$ 558.65	
		30"(762mm)	E2JF-3054	318.27	370.24	421.44	538.44	619.68	668.41	
		36"(914mm)	E2JF-354	372.06	432.94	492.72	629.52	724.62	781.60	
		42"(1067mm)	E2JF-4254	424.22	493.74	561.84	717.84	826.38	891.36	
		48"(1219mm)	E2JF-454	478.01	556.44	633.12	808.92	931.32	1004.55	
64"(1626mm)	60"(1524mm)	24"(610mm)	E2JF-262	\$ 297.08	\$345.54	\$ 393.36	\$ 502.56	\$ 578.34	\$ 623.82	
		30"(762mm)	E2JF-3062	357.39	415.84	473.28	604.68	696.00	750.73	
		36"(914mm)	E2JF-362	419.33	488.04	555.36	709.56	816.84	881.07	
		42"(1067mm)	E2JF-4262	479.64	558.34	635.28	811.68	934.50	1007.98	
		48"(1219mm)	E2JF-462	539.95	628.64	715.20	913.80	1052.16	1134.89	
72"(1829mm)	68"(1727mm)	24"(610mm)	E2JF-270	\$328.05	\$ 381.64	\$ 434.40	\$ 555.00	\$ 638.76	\$ 688.99	
		30"(762mm)	E2JF-3070	396.51	461.44	525.12	670.92	772.32	833.05	
		36"(914mm)	E2JF-370	464.97	541.24	615.84	786.84	905.88	977.11	
		42"(1067mm)	E2JF-4270	533.43	621.04	706.56	902.76	1039.44	1121.17	
		48"(1219mm)	E2JF-470	601.89	700.84	797.28	1018.68	1173.00	1265.23	
80"(2032mm)	76"(1930mm)	24"(610mm)	E2JF-278	\$360.65	\$ 419.64	\$ 477.60	\$ 610.20	\$ 702.36	\$ 757.59	
		30"(762mm)	E2JF-3078	435.63	507.04	576.96	737.16	848.64	915.37	
		36"(914mm)	E2JF-378	512.24	596.34	678.48	866.88	998.10	1076.58	
		42"(1067mm)	E2JF-4278	588.85	685.64	780.00	996.60	1147.56	1237.79	
		48"(1219mm)	E2JF-478	665.46	774.94	881.52	1126.32	1297.02	1399.00	
		60"(1524mm)	E2JF-578	817.05	951.64	1082.40	1383.00	1592.76	1717.99	

Upper Inserts

UniGroup Too

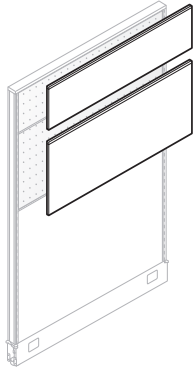

E2TF

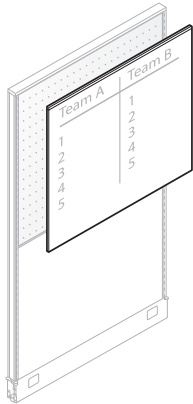

E2TM
Class AC

Feature

- Includes one insert and segment trim strip or markerboard tray.

Specification Tips

- For markerboard installation allow clearance above panel equal to height of insert.
- Must be used with monolithic core panel and base insert, separately specified.
- Maximum of 4 upper inserts is allowed per panel side.
- Base and/or upper insert combinations may vary per panel side.
- Markerboard cleaner & conditioner, order service part #7031-7001.
- Order markerboard with tray in lower application to protect lower fabric insert.

(M) Product marked with this symbol available as GSA open market.

To Order, Specify:

- 1) Product number, including:

1 Markerboard Option:

- N** Markerboard with segment trim strip
- M** Markerboard with tray

- 2) Fabric/colorway (for fabric insert).
- 3) Trim color for segment trim strip or markerboard tray.

Insert Height	Width	Number	Fabric						
			A	B	C	E	F	G	
Trim A									
8"(203mm)	24"(610mm)	E2TF-208	\$ 115.75	\$ 143.53	\$ 152.28	\$ 191.08	\$ 219.86	\$ 237.23	
	30"(762mm)	E2TF-3008	128.74	158.47	169.39	212.96	244.88	264.22	
	36"(914mm)	E2TF-308	191.73	223.41	236.50	284.84	319.90	341.21	
	42"(1067mm)	E2TF-4208	204.72	238.35	253.61	306.72	344.92	368.20	
	48"(1219mm)	E2TF-408	217.71	253.29	270.72	328.60	369.94	395.19	
	60"(1524mm)	E2TF-508	243.69	283.17	304.94	372.36	419.98	449.17	
16"(406mm)	24"(610mm)	E2TF-216	\$ 158.72	\$ 193.04	\$ 208.97	\$ 263.46	\$ 302.69	\$ 326.60	
	30"(762mm)	E2TF-3016	171.71	207.98	226.08	285.34	327.71	353.59	
	36"(914mm)	E2TF-316	234.70	272.92	293.19	357.22	402.73	430.58	
	42"(1067mm)	E2TF-4216	247.69	287.86	310.30	379.10	427.75	457.57	
	48"(1219mm)	E2TF-416	260.68	302.80	327.41	400.98	452.77	484.56	
	60"(1524mm)	E2TF-516	286.66	332.68	361.63	444.74	502.81	538.54	
Trim B									
8"(203mm)	24"(610mm)	E2TF-208	\$ 161.37	\$ 189.15	\$ 197.90	\$ 236.70	\$ 265.48	\$ 282.85	
	30"(762mm)	E2TF-3008	174.36	204.09	215.01	258.58	290.50	309.84	
	36"(914mm)	E2TF-308	237.35	269.03	282.12	330.46	365.52	386.83	
	42"(1067mm)	E2TF-4208	250.34	283.97	299.23	352.34	390.54	413.82	
	48"(1219mm)	E2TF-408	263.33	298.91	316.34	374.22	415.56	440.81	
	60"(1524mm)	E2TF-508	289.31	328.79	350.56	417.98	465.60	494.79	
16"(406mm)	24"(610mm)	E2TF-216	\$204.34	\$238.66	\$254.59	\$309.08	\$348.31	\$372.22	
	30"(762mm)	E2TF-3016	217.33	253.60	271.70	330.96	373.33	399.21	
	36"(914mm)	E2TF-316	280.32	318.54	338.81	402.84	448.35	476.20	
	42"(1067mm)	E2TF-4216	293.31	333.48	355.92	424.72	473.37	503.19	
	48"(1219mm)	E2TF-416	306.30	348.42	373.03	446.60	498.39	530.18	
	60"(1524mm)	E2TF-516	332.28	378.30	407.25	490.36	548.43	584.16	

			Trim			
			A	B	N	M
16"(406mm)	24"(610mm)	E2TM-216- (M)	\$ 516.60	\$ 552.82	\$ 564.90	\$ 601.12
	30"(762mm)	E2TM-3016- (M)	552.23	588.45	612.61	648.83
	36"(914mm)	E2TM-316- (M)	587.86	624.08	660.32	696.54
	42"(1067mm)	E2TM-4216- (M)	623.49	659.71	708.03	744.25
	48"(1219mm)	E2TM-416- (M)	659.12	695.34	755.74	791.96
	60"(1524mm)	E2TM-516- (M)	730.38	766.60	851.16	887.38
32"(813mm)	24"(610mm)	E2TM-232- (M)	\$784.90	\$ 821.12	\$ 881.47	\$ 917.69
	30"(762mm)	E2TM-3032- (M)	820.53	856.75	929.18	965.40
	36"(914mm)	E2TM-332- (M)	856.16	892.38	976.89	1013.11
	42"(1067mm)	E2TM-4232- (M)	891.79	928.01	1024.60	1060.82
	48"(1219mm)	E2TM-432- (M)	927.42	963.64	1072.31	1108.53
	60"(1524mm)	E2TM-532- (M)	998.68	1034.90	1167.73	1203.95

Fabric Add-On Panel

UniGroup Too

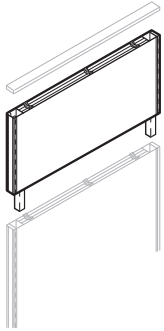

E2AM
Class AC

Note: This panel has fabric/colorway restrictions, see systems fabrics/ color legend.

Features

- Includes panel, vertical connector (bayonet), light block, side trim rails, two full hinge sets and top cap clips.
- Fabric add-on panels may be installed above straight fabric and laminate base or fabric add-on panels.
- Both sides in same fabric; one color or different color each side.
- Each base panel will accept two add-on panels.
- Lower Level add-on panel will accept overhead components (load bearing). Second add-on panel (top) is non-load bearing.
- Utilizes top cap from base panel.
- Same construction as UniGroup Too Basic Monolithic fabric panel.

Specification Tips

- Add-on panels may be stacked a maximum of two high above a UniGroup Too base panel.
- Add-on panel must match panel width.
- Combination of panel and add-on panel cannot exceed 80”(2032mm) in height.
- Cannot be used above doors or glazed panels.
- Base and add-on panel combinations should match existing base panel heights so that end-of-runs and finish posts can be used without field modification.
- Finish posts may be used, separately specified.
- Full-height side trim rails required for end-of-run conditions with a base panel and one add-on panel, separately specified.
- For two high add-on panel applications specify separately full-height side trim rail for base panel and one high add-on, for two high panel add-on location use side trim rail that ships with add-on panel. See Specification Guide for application guidelines.
- Clerestory can be added above fabric add-on panel. See Specification Guide for application guidelines.

To Order, Specify:

- 1) Product number.
- 2) Fabric/colorway for add-on panel side one.
- 3) Fabric/colorway for add-on panel side two.
- 4) Trim color for side trim rails and trim strip.

Note: For mixed grade fabric surfaces pricing will be determined by the sum of the upcharges. Please refer to the electronic catalog.

Actual Height	Width	Number	Fabric					G
			A	B	C	E	F	
Trim A								
16”(406mm)	24”(610mm)	E2AM-216	\$ 893.65	\$ 993.23	\$ 1102.75	\$ 1341.63	\$ 1500.91	\$ 1600.51
	30”(762mm)	E2AM-3016	934.09	1039.55	1156.03	1409.79	1578.91	1684.51
	36”(914mm)	E2AM-316	974.53	1085.87	1209.31	1477.95	1656.91	1768.51
	42”(1067mm)	E2AM-4216	1014.97	1132.19	1262.59	1546.11	1734.91	1852.51
	48”(1219mm)	E2AM-416	1062.15	1186.23	1324.75	1625.63	1825.91	1950.51
	60”(1524mm)	E2AM-516	1136.29	1271.15	1422.43	1750.59	1968.91	2104.51
Trim B								
16”(406mm)	24”(610mm)	E2AM-216	\$ 897.75	\$ 997.33	\$ 1106.85	\$ 1345.73	\$ 1505.01	\$ 1604.61
	30”(762mm)	E2AM-3016	938.19	1043.65	1160.13	1413.89	1583.01	1688.61
	36”(914mm)	E2AM-316	978.63	1089.97	1213.41	1482.05	1661.01	1772.61
	42”(1067mm)	E2AM-4216	1019.07	1136.29	1266.69	1550.21	1739.01	1856.61
	48”(1219mm)	E2AM-416	1066.25	1190.33	1328.85	1629.73	1830.01	1954.61
	60”(1524mm)	E2AM-516	1140.39	1275.25	1426.53	1754.69	1973.01	2108.61

Glazed Add-On Panel

UniGroup Too

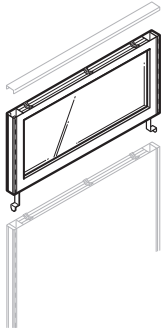

E2AG
Class AC

Features

- Includes panel, vertical connector (bayonet), light block, side trim rails, two full hinge sets and top cap clips.
- Utilizes top cap from monolithic panel.
- Glazed add-on panels may be installed above glazed, fabric, laminate, fabric add-on or glazed add-on panels.
- Glazed add-on panels will not accept any load bearing components.
- Textured glazing material is textured on one side only. Recommend installing the textured side to face the interior of the workstation.

Specification Tips

- Add-on panels may be stacked a maximum of two high above a monolithic panel.
- Add-on panel width must match base panel width.
- Combination of base panel and add-on panel cannot exceed 80"(2032mm).
- Cannot be used above doors.
- Does not accept top feed modules.
- Add-on panels may be retrofitted in the field for use on glazed or fabric monolithic panels.
- To convert a glazed add-on above a fabric/laminate monolithic base panel to a glazed add-on above a glazed base panel or (vice versa), a vertical connector (bayonet) retrofit kit is available. Order separately through Haworth e-Parts.
- Finish posts may be used, separately specified.
- Full-height side trim rails required for end-of-run conditions with a base panel and one add-on panel, separately specified.
- For two high add-on panel applications specify separately full-height side trim rail for base panel and one high add-on, for two high panel add on location use side trim rail that ships with add-on panel.
- Clerestory can be added above glazed add-on panel. See Specification Guide for application guidelines.

To Order, Specify:

1) Product number, including:

1 Application Designation:

F Glazed add-on panel **above fabric/laminate base panel or fabric add-on panel**

G Glazed add-on panel **above glazed or glazed add-on panel** (add **\$48.82** list)

2) Glazing color or glass pattern.

3) Trim color for frame, side trim rails and trim strip.

Actual Height	Width	Number ^①	Glass		
			A	C	D
Trim A					
16"(406mm)	24"(610mm)	E2AG-216-■	\$1242.89	\$ 1391.37	\$ 1614.08
	30"(762mm)	E2AG-3016-■	1293.05	1493.25	1737.98
	36"(914mm)	E2AG-316-■	1343.21	1595.13	1861.88
	42"(1067mm)	E2AG-4216-■	1393.37	1697.01	1985.78
	48"(1219mm)	E2AG-416-■	1443.53	1798.89	2109.68
	60"(1524mm)	E2AG-516-■	1618.85	2077.65	2432.48
Trim B					
16"(406mm)	24"(610mm)	E2AG-216-■	\$1252.41	\$ 1400.89	\$ 1623.60
	30"(762mm)	E2AG-3016-■	1304.48	1504.68	1749.41
	36"(914mm)	E2AG-316-■	1356.55	1608.47	1875.22
	42"(1067mm)	E2AG-4216-■	1408.62	1712.26	2001.03
	48"(1219mm)	E2AG-416-■	1460.69	1816.05	2126.84
	60"(1524mm)	E2AG-516-■	1639.83	2098.63	2453.46

Panel Accessories

UniGroup Too

Sliding Door

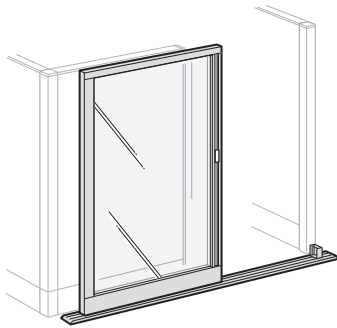

VUZF
(Left-hand door)
Class CA

Features

- Includes sliding door with threshold track and optional lock.
- Available with clear glass or frosted acrylic door insert.
- Full height vertical recessed door handle.
- Sliding Door adjustable wheels allow 1.25"(32mm) height adjustment.
- Optional door lock is available; locks with key outside and lever inside. Not field retrofittable.
- Lock plugs come standard in black.
- For lock options, refer to Lock Program Price List.
- Locking mechanism locks the door into the track.
- Right-handed door slides open to right.
- Left-handed door slides open to left.

Specification Tips

- Handedness cannot be changed in the field.
- Sliding Door mounts outside of the workspace.
- Threshold track is included and must be used with the Sliding Door.
- Sliding Door can be attached to panel of same height or taller. Cannot be attached to panel lower than sliding door.
- Sliding Door Filler Post is required in certain applications and ordered separately. Refer to Specification Guide.
- Sliding Door extends 34"(864mm) for the 36"(914mm)W sliding door and 40"(1016mm) for the 42"(1067mm)W sliding door.

To Order, Specify:

1) Product number, including:

1 Insert Option:

- G** Clear (SG-1C)
- X** Frosted (SK-1E)

2 Handedness Option:

- R** Right
- L** Left

3 Locking Option:

- N** Non-Locking
- L** Locking (add **\$657.07** list)

2) Trim color.

Nominal Height	Nominal Width	Number ①②③	Clear Trim		Frosted Trim	
			A	B	A	B
64"(1626mm)	36"(914mm)	VUZF-6436- ■■■ E	\$ 4812.14	\$4836.98	\$ 5381.46	\$5406.30
	42"(1067mm)	VUZF-6442- ■■■ E	5100.57	5127.18	5909.51	5936.12
72"(1829mm)	36"(914mm)	VUZF-7236- ■■■ E	\$ 4927.82	\$ 4981.02	\$5583.02	\$5636.22
	42"(1067mm)	VUZF-7242- ■■■ E	5216.25	5271.22	6111.07	6166.04
80"(2032mm)	36"(914mm)	VUZF-8036- ■■■ E	\$5043.50	\$ 5125.06	\$5784.58	\$5866.14
	42"(1067mm)	VUZF-8042- ■■■ E	5331.93	5415.26	6312.63	6395.96

Filler Post — Sliding Door

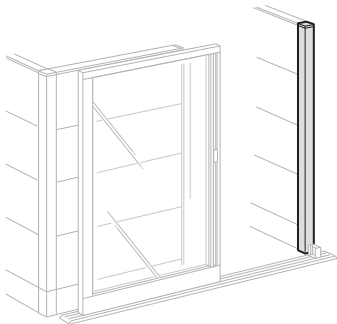

VEZP
Class CA

Feature

- Includes painted filler post with square painted top cap and attachment hardware.

Specification Tips

- Filler post is required for certain Sliding Door applications. Refer to Specification Guide.
- Specify filler post to match panel height in all applications.
- Filler post is only available with UniGroup Too square profile trim.

To Order, Specify:

- 1) Product number.
- 2) Trim color for filler post.
- 3) Trim color for top cap.

Nominal Height	Number	Trim	
		A	B
64"(1626mm)	VEZP-6400-P	\$840.58	\$878.69
72"(1829mm)	VEZP-7200-P	888.97	927.08
80"(2032mm)	VEZP-8000-P	953.49	991.60

Swing Door

UniGroup Too

Single Door

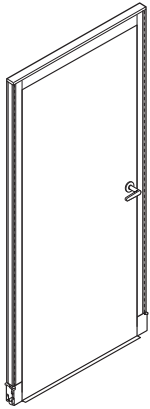

E2DS



(Left-hand swing)
Class AC

Features

- Includes complete panel assembly [hinge sets, carpet gripper, door jamb, side trim rails, leveling glides and trim, hollow core door (1.625" (41mm) thick), door hinges, hardware, ADA lever with lockset and keys, and threshold].
- Door shipped with left-hand swing and can be field-changed for right-hand swing.
- Both sides of door covered in same laminate surface color.
- No power/communications in base raceway.

Specification Tips

- Door may be placed a maximum of 24" (610mm) from supporting panels at 90°.
- Will not accept add-on panel.

Door Opening Clearance

Door Size	Height	Width
3678	78" (1981mm)	28.75" (730mm)
4278	78" (1981mm)	34.75" (883mm)

To Order, Specify:

- 1) Product number.
- 2) Laminate surface color.
- 3) Trim color for raceway covers and glide housings. Not available in metallic trim colors.
- 4) Trim color for door jamb, top cap and side trim rails.

Notes: Some building codes may restrict the use of panel heights greater than 69" (1753mm). Consult your local code authority to assure that the furniture layout is compliant prior to installation.

Most building codes for new buildings require a minimum clear door width of 32" (813mm). To meet this requirement, the 42" (1067mm) door must be ordered.

Actual Height	Width	Number	HPL A Trim		HPL B Trim	
			A	B	A	B
80" (2032mm)	36" (914mm)	E2DS-3678-BHL	\$ 5315.97	\$5369.79	\$5441.53	\$5495.35
	42" (1067mm)	E2DS-4278-BHL	5576.01	5629.83	5701.57	5755.39

Panel Accessories

UniGroup Too

90° Full-Height Finish Post — Square Painted Top Cap

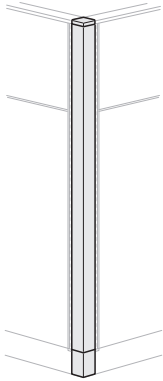

E2PC
Class AC

Feature

- Includes 90° vertical cover, square painted top cap and base raceway cover.

Specification Tips

- For use with equal height panels in a 90°, 2-Way condition.
- For use with UniGroup Too square painted top cap panels.
- Required by UL for covering base raceway flexible and Straight power connectors when power connector covers are not used.

To Order, Specify:

- 1) Product number:
- 2) Paint color for finish post.
- 3) Trim color for raceway cover.
- 4) Trim color for top cap.

Note: For mixed grade trim surfaces pricing will be determined by the sum of the upcharges. Please refer to the electronic catalog.

Actual Height	Number	Trim	
		A	B
32"(813mm)	E2PC-30	\$ 148.36	\$ 166.54
40"(1016mm)	E2PC-38	163.64	185.18
48"(1219mm)	E2PC-46	178.92	203.82
56"(1422mm)	E2PC-54	194.20	222.46
64"(1626mm)	E2PC-62	209.48	241.10
72"(1829mm)	E2PC-70	224.76	259.74
80"(2032mm)	E2PC-78	240.04	278.38

90° Variable-Height Finish Post — Square Painted Top Cap

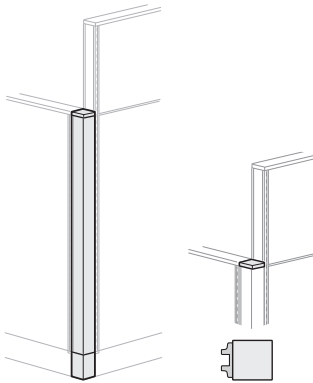

E2PC-V
Class AC

Feature

- Includes 90° vertical cover, square painted top cap and base raceway cover.

Specification Tips

- For use with multiple height panels in a 90°, 2-Way condition; specify height to match lowest panel height.
- For use with UniGroup Too square painted top cap panels.
- Required by UL for covering base raceway power connectors when power connector covers are not used.

To Order, Specify:

- 1) Product number:
- 2) Paint color for finish post.
- 3) Trim color for raceway cover.
- 4) Trim color for top cap.

Actual Height	Number	Trim	
		A	B
32"(813mm)	E2PC-30-V	\$ 176.58	\$ 194.76
40"(1016mm)	E2PC-38-V	191.86	213.40
48"(1219mm)	E2PC-46-V	207.14	232.04
56"(1422mm)	E2PC-54-V	222.42	250.68
64"(1626mm)	E2PC-62-V	237.70	269.32
72"(1829mm)	E2PC-70-V	252.98	287.96

90° Power Connector Cover — Square Profile

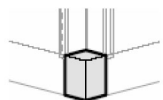

E2PC-90-B
Class AC

Features

- Includes six covers.
- For use with UniGroup Too square painted top cap panels.
- Required by UL for covering power connector 90° panel condition when finish post is not used.

To Order, Specify:

- 1) Product number.
- 2) Trim color.

Height	Number	Trim	
		A	B
4"(102mm)	E2PC-90-B	\$116.09	\$145.63

Panel Accessories

UniGroup Too

120° Full-Height Finish Post — Square Painted Top Cap

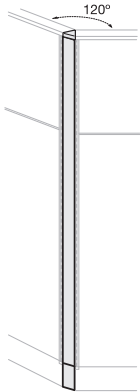

E2PA
Class AC

Feature

- Includes 120° vertical cover, square painted top cap and base raceway cover.

Specification Tips

- For use with equal height panels in a 120°, 2-Way condition.
- For use with UniGroup Too square top cap panels.
- Required by UL for covering base raceway power connectors when power connector covers are not used.

To Order, Specify:

- 1) Product number:
- 2) Paint color for finish post.
- 3) Trim color for raceway cover.
- 4) Trim color for top cap.

Note: For mixed grade trim surfaces pricing will be determined by the sum of the upcharges. Please refer to the electronic catalog.

Actual Height	Number	Trim	
		A	B
32"(813mm)	E2PA-30	\$ 166.01	\$ 180.30
40"(1016mm)	E2PA-38	178.41	196.14
48"(1219mm)	E2PA-46	190.81	211.98
56"(1422mm)	E2PA-54	203.21	227.82
64"(1626mm)	E2PA-62	215.61	243.66
72"(1829mm)	E2PA-70	228.01	259.50
80"(2032mm)	E2PA-78	240.41	275.34

120° Variable-Height Finish Post — Square Painted Top Cap

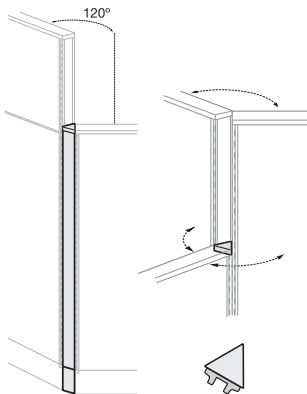

E2PA-V
Class AC

Feature

- Includes 120° vertical cover, square painted top cap and base raceway cover.

Specification Tips

- For use with multiple height panels in a 120°, 2-Way condition; specify height to match lowest panel height.
- For use with UniGroup Too square painted top cap panels.
- Required by UL for covering base raceway power connectors when power connector covers are not used.

To Order, Specify:

- 1) Product number:
- 2) Paint color for finish post.
- 3) Trim color for raceway cover.
- 4) Trim color for top cap.

Notes: For mixed grade trim surfaces pricing will be determined by the sum of the upcharges. Please refer to the electronic catalog.

Actual Height	Number	Trim	
		A	B
32"(813mm)	E2PA-30-V	\$ 194.01	\$ 208.30
40"(1016mm)	E2PA-38-V	206.41	224.14
48"(1219mm)	E2PA-46-V	218.81	239.98
56"(1422mm)	E2PA-54-V	231.21	255.82
64"(1626mm)	E2PA-62-V	243.61	271.66
72"(1829mm)	E2PA-70-V	256.01	287.50

120° Power Connector Cover

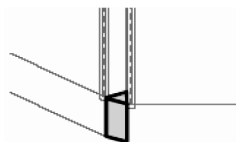

E2PC-120-B
Class AC

Features

- Includes six covers.
- For use with UniGroup Too square painted top cap panels.
- Required by UL for covering power connector 120° panel condition when finish post is not used.

Specification Tip

- Can also be used with UniGroup.

To Order, Specify:

- 1) Product number.
- 2) Trim color.

Height	Number	Trim	
		A	B
4"(102mm)	E2PC-120-B	\$116.09	\$145.63

Panel Accessories

UniGroup Too

180° Full-Height Finish Post — Square Painted Top Cap

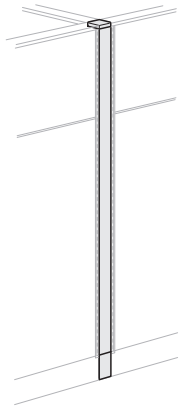

E2PS
Class AC

Feature

- Includes 180° vertical cover, square painted top cap and base raceway cover.

Specification Tips

- For use with equal height panels in a 180°, 3-Way condition.
- For use with panels with UniGroup Too square painted top cap.
- Required by UL for covering base raceway power connectors when power connector covers are not used.

To Order, Specify:

- 1) Product number:
- 2) Paint color for finish post.
- 3) Trim color for raceway cover.
- 4) Trim color for top cap.

Note: For mixed grade trim surfaces pricing will be determined by the sum of the upcharges. Please refer to the electronic catalog.

Actual Height	Number	Trim	
		A	B
32"(813mm)	E2PS-30	\$ 119.10	\$ 137.36
40"(1016mm)	E2PS-38	133.18	154.96
48"(1219mm)	E2PS-46	147.26	172.56
56"(1422mm)	E2PS-54	161.34	190.16
64"(1626mm)	E2PS-62	175.42	207.76
72"(1829mm)	E2PS-70	189.50	225.36
80"(2032mm)	E2PS-78	203.58	242.96

180° Variable-Height Finish Post — Square Painted Top Cap

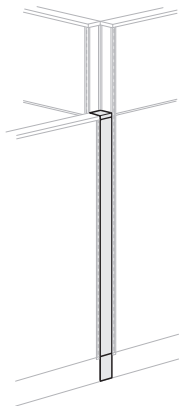

E2PS-V
Class AC

Features

- Includes 180° vertical cover, square painted top cap and base raceway cover.
- Includes top cap with one or two alignment tabs; specify accordingly.

Specification Tips

- For use with multiple height panels in a 180°, 3-Way condition; specify height to match lowest panel height.
- Product specification must reflect number of top cap alignment tabs for lowest like panel heights in an "I" or "L" condition; see Product Application Guidelines for details.
- Top cap alignment tabs are for dedicated applications and are not field removable; -V1, -V2I, -V2L.
- For use with panels with UniGroup Too square painted top cap.
- Required by UL for covering base raceway power connectors when power connector covers are not used.

To Order, Specify:

- 1) Product number:
- 2) Paint color for finish post.
- 3) Trim color for raceway cover.
- 4) Trim color for top cap.

Note: For mixed grade trim surfaces pricing will be determined by the sum of the upcharges. Please refer to the electronic catalog.

Actual Height	Number	Trim	
		A	B
32"(813mm)	E2PS-30-V1	\$ 147.10	\$ 165.36
	E2PS-30-V2I	147.10	165.36
	E2PS-30-V2L	147.10	165.36
40"(1016mm)	E2PS-38-V1	\$ 161.18	\$ 182.96
	E2PS-38-V2I	161.18	182.96
	E2PS-38-V2L	161.18	182.96
48"(1219mm)	E2PS-46-V1	\$ 175.26	\$ 200.56
	E2PS-46-V2I	175.26	200.56
	E2PS-46-V2L	175.26	200.56
56"(1422mm)	E2PS-54-V1	\$ 189.34	\$ 218.16
	E2PS-54-V2I	189.34	218.16
	E2PS-54-V2L	189.34	218.16
64"(1626mm)	E2PS-62-V1	\$ 203.42	\$ 235.76
	E2PS-62-V2I	203.42	235.76
	E2PS-62-V2L	203.42	235.76
72"(1829mm)	E2PS-70-V1	\$ 217.50	\$ 253.36
	E2PS-70-V2I	217.50	253.36
	E2PS-70-V2L	217.50	253.36
80"(2032mm)	E2PS-78-V2I	\$ 231.58	\$ 270.96

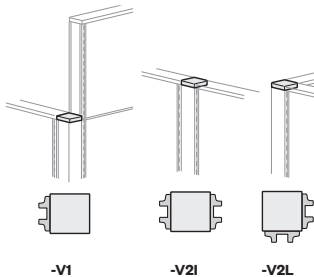

Panel Accessories

UniGroup Too

180° Power Connector Cover

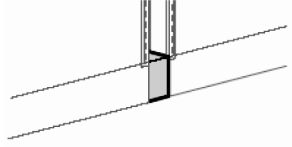

PPC-180-B
Class AA

- Includes six covers.
- For use with UniGroup Too square painted top cap panels.
- Required by UL for covering power connector 180° panel condition when finish post is not used.

Specification Tip

- Can also be used with UniGroup.

To Order, Specify:

- 1) Product number.
- 2) Trim color.

Height	Number	Price
4"(102mm)	PCC-180-B	\$136.10

180° Vertical Cover only, (no top cap or base raceway cover)

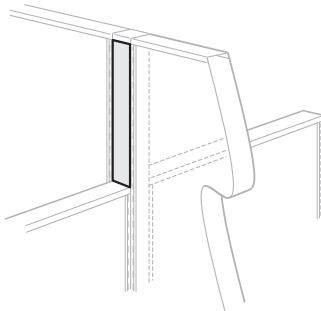

E2PS-N
Class AC

Feature

- Includes 180° vertical cover only.

Specification Tips

- For use with separately specified 180° finish post or 90° top cap.
- See Specification Guide for details.

To Order, Specify:

- 1) Product number:
- 2) Paint color for finish post.

Actual Height	Number	Trim	
		A	B
8"(203mm)	E2PS-08-N	\$ 46.73	\$ 75.20
16"(406mm)	E2PS-16-N	61.13	89.60
24"(610mm)	E2PS-24-N	75.53	104.00
32"(813mm)	E2PS-32-N	89.93	118.40
40"(1016mm)	E2PS-40-N	104.33	132.80
48"(1219mm)	E2PS-48-N	118.73	147.20

Panel Accessories

UniGroup Too

90° Square Painted Top Cap for 2-Way, 3-Way, 4-Way

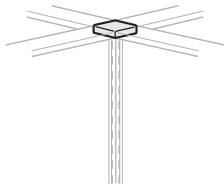

E2CC-90
Class AC

Features

- Includes square painted top cap for 90° or 180° panel intersection.
- Includes one, two, three, or four alignment tabs; specify accordingly.

Specification Tips

- Typically used with separately specified 180° Vertical Cover unless used in a 4-way condition with equal height panels.
- Product specification must reflect number of top cap alignment tabs for like panel heights in an "I", "L", "T", or "X" condition.
- See Product Specification Guide for details.
- Top cap alignment tabs are for dedicated applications and are not field removable.

To Order, Specify:

- 1) Product number.
- 2) Trim color.

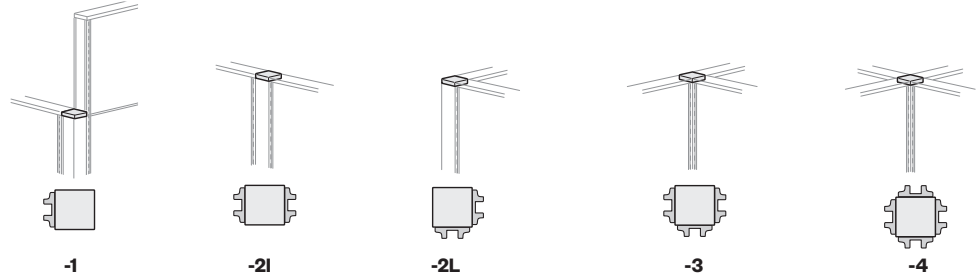

Number	Trim	
	A	B
E2CC-90-1	\$88.67	\$120.34
E2CC-90-2I	88.67	120.34
E2CC-90-2L	88.67	120.34
E2CC-90-3	88.67	120.34
E2CC-90-4	88.67	120.34

120° Square Painted Top Cap for 2-Way or 3-Way

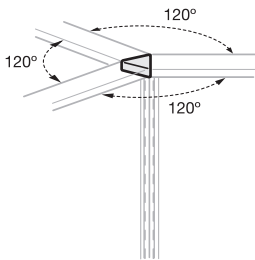

E2CA-120
Class AC

Features

- Includes square painted top cap for 120° panel intersection.
- Includes one, two or three alignment tabs; specify accordingly.

Specification Tips

- Product specification must reflect number of top cap alignment tabs for like panel heights in 120° 2-Way or 3-Way condition.
- For use in 120° 3-Way condition with equal height panels; specify **(-3)** option.
- For use in 120° 3-way condition with one high and two equal height lower panels; specify **(-2)** option.
- See Product Specification Guide for details.
- Top cap alignment tabs are for dedicated applications and are not field removable.
- Not for use with the 180° Vertical Cover.

To Order, Specify:

- 1) Product number.
- 2) Trim color.

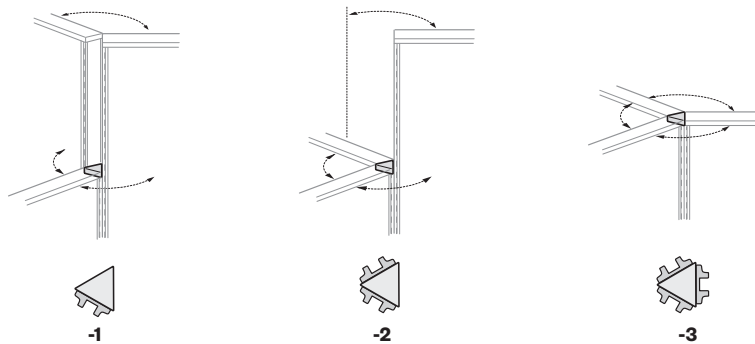

Number	Trim	
	A	B
E2CA-120-1	\$112.62	\$146.02
E2CA-120-2	112.62	146.02
E2CA-120-3	112.62	146.02

Panel Accessories

UniGroup Too

Top Cap Aligner

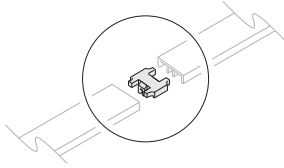

E2AL-1
Class AC

Features

- Includes one top cap aligner.
- For use with UniGroup Too square painted top cap in an in-line panel condition.
- Top cap alignment tabs are for dedicated applications and not field removable.

Note: One top cap aligner is included with each panel.

To Order, Specify:

- 1) Product number.
- 2) Trim color.

	Number	Trim	
		A	B
	E2AL-1	\$48.54	\$78.08

Top Cap End Plug

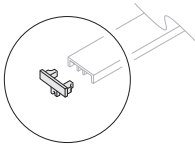

E2EC-1
Class AC

Features

- Includes one top cap end plug.
- For use with UniGroup Too square top cap panels.
- Additional top cap end plugs may be needed if finish posts are not specified.

Note: **.6 top cap end plugs are included with each panel.**
Order additional as necessary.

To Order, Specify:

- 1) Product number.
- 2) Trim color.

	Number	Trim	
		A	B
	E2EC-1	\$36.63	\$51.69

Base Raceway End Cap



EC-10-B
Class AA

Features

- Includes ten end caps.
- For use at base raceway for end-of-run panel condition.

Note: **.6 end caps included with every panel.**
Order additional as necessary.

To Order, Specify:

- 1) Product number.
- 2) Trim color.

Height	Number	Trim	
		A	B
4" (102mm)	EC-10-B	\$73.76	\$83.91

Panel Accessories

UniGroup Too

Full Height Side Trim Rail — for use with Add-On Panels

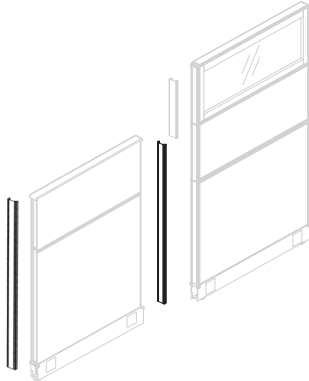

SREH
Class AA

Feature

- Includes one full height side trim rail.

Specification Tips

- For use with base panel and one add-on panel.
- For two high add-on panel applications specify separately full-height side trim rail for base panel and one high add-on, for two high panel location use side trim rail that ships with add-on panel. See Specification Guide for application guidelines.

To Order, Specify:

- 1) Product number.
- 2) Trim color.

Height	Base Panel Height/ Add-On Panel	Number	Trim	
			A	B
48"(1219mm)	32"(813mm)/16"(406mm)	SREH-3016	\$ 182.81	\$ 231.69
56"(1422mm)	40"(1016mm)/16"(406mm)	SREH-3816	192.49	259.13
64"(1626mm)	48"(1219mm)/16"(406mm)	SREH-4616	202.17	286.57
72"(1829mm)	56"(1422mm)/16"(406mm)	SREH-5416	211.85	314.01
80"(2032mm)	64"(1626mm)/16"(406mm)	SREH-6216	221.53	341.45

Side Trim Rail



SRE
Class AA

Feature

- Includes one side trim rail.

Specification Tips

- Specify two side trim rails for each condition.
- Two side trim rails are included with each panel. Order as replacement only.
- For use with UniGroup Too panels only.

To Order, Specify:

- 1) Product number.
- 2) Trim color.

Panel Height	Number	Trim	
		A	B
32"(813mm)	SRE-30	\$136.90	\$ 150.26
40"(1016mm)	SRE-38	146.58	177.70
48"(1219mm)	SRE-46	156.26	205.14
56"(1422mm)	SRE-54	165.94	232.58
64"(1626mm)	SRE-62	175.62	260.02
72"(1829mm)	SRE-70	185.30	287.46
80"(2032mm)	SRE-78	194.98	314.90

Panel Accessories

UniGroup Too

Hinges

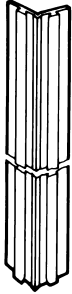

HE
Class AA

Features

- Includes one hinge set for one side of trim rail.
- One hinge set connects every two panels for angular connections.
- Two hinge sets are used for straight-line conditions.
- For replacement only. Hinges are included with panels.

Specification Tip

- For use with UniGroup Too panels only.

To Order, Specify:

- 1) Product number.
- 2) Trim color.

Panel Height	Number	Price
32"(813mm)	HE-30	\$24.14
40"(1016mm)	HE-38	24.70
48"(1219mm)	HE-46	25.26
56"(1422mm)	HE-54	26.38
64"(1626mm)	HE-62	26.94
72"(1829mm)	HE-70	27.50
80"(2032mm)	HE-78	28.62

Wall Track

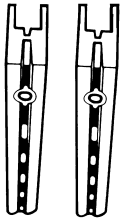

WT
Class AA

Features

- Includes two wall tracks and attachment screws (#10 2.5"(51mm) long).
- For attachment of components to structural walls.
- See installation instructions for proper mounting.

Specification Tip

- Not for use with up-mount overhead storage unit.

To Order, Specify:

- 1) Product number.
- 2) Trim color for track.

Height	Depth	Width	Number	Trim	
				A	B
60"(1524mm)	0.75"(19mm)	0.625"(16mm)	WT-60	\$268.80	\$282.19
72"(1829mm)			WT-72	315.58	328.97
84"(2134mm)			WT-84	362.36	375.75

Wall Mount Kit



WMK
Class AA

Features

- Includes wall-mount channel, hinges and screws.
- For mounting panels, with or without add-on panel, to a structural wall.
- Adds 0.25"(6mm) to the panel width.

Specification Tip

- Must be properly anchored to a structural wall.

To Order, Specify:

- 1) Product number.
- 2) Trim color.

Height	Number	Trim	
		A	B
32"(813mm)	WMK-32	\$ 136.64	\$ 141.14
40"(1016mm)	WMK-38	168.14	172.64
48"(1219mm)	WMK-46	204.14	208.64
56"(1422mm)	WMK-54	235.64	240.14
64"(1626mm)	WMK-62	271.64	276.14
72"(1829mm)	WMK-70	307.64	312.14
80"(2032mm)	WMK-78	348.14	352.64

Panel Accessories

UniGroup Too

T-Mount Kits

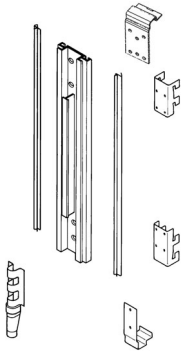

E2TK
Class AC

Features

- Includes pre-drilled side rail, center-mount brackets, end-mount brackets, light block extrusions, glide housing, and screws.
- Brackets included for both center- and end-mount T-conditions.
- Connects two panels in a T-condition. T-mount can attach to a base panel and one fabric add-on panel. Configuration coming off of a T-mount cannot contain add-on panels.

Specification Tips

- Both panels in a T-mount condition must be of equal height.
- Cannot mount on glazed panels, glazed add-on panels or doors.
- Must be used with UniGroup Too panels only.

To Order, Specify:

- 1) Product number.
- 2) Trim color.

Height	Number	Trim	
		A	B
32"(813mm)	E2TK-30	\$ 337.78	\$ 339.91
40"(1016mm)	E2TK-38	357.38	361.19
48"(1219mm)	E2TK-46	376.98	382.47
56"(1422mm)	E2TK-54	396.58	403.75
64"(1626mm)	E2TK-62	416.18	425.03
72"(1829mm)	E2TK-70	435.78	446.31
80"(2032mm)	E2TK-78	455.38	467.59

All-Purpose Hook

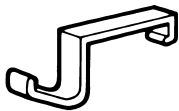

E2CH-8
Class AC

Features

- Includes eight hooks.
- For use with UniGroup Too square painted top cap panels.

To Order, Specify:

- 1) Product number.
- 2) Trim color.

Number	Trim	
	A	B
E2CH-8	\$183.04	\$215.31

Seismic Anchoring Bracket

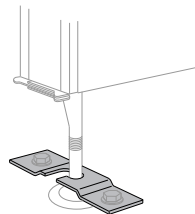

HAB
Class AC

Features

- Includes package of six formed steel brackets.
- For seismic anchoring of UniGroup Too and UniGroup panels.

To Order, Specify:

- 1) Product number.
(No finish specification required.)

Number	Price
HAB-0001	\$366.36

Friction Pad



7031-0501
Class BA

Feature

- Includes one pad.

Specification Tip

- Attaches to bottom of glide to prevent movement of panels on hard surface flooring.

To Order, Specify:

- 1) Product number.
(No finish specification required.)

Number	Price
7031-0501	\$20.83

Monolithic Panel with Steel Top Cap — No Power

UniGroup

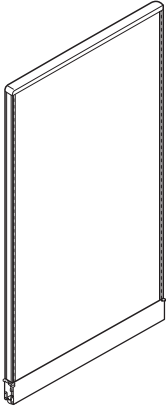

EFN-B (Non-Powered)
Class AA

Note: This panel has fabric/colorway restrictions, see Systems Fabric/ Color Legend.

Features

- Includes non-powered panel assembly, radius steel top cap, with or without one-piece base raceway cover, 1.6 hinge kits, side trim rails, leveling glides and carpet gripper. **.6** base raceway end caps are shipped with each panel. Order additional as necessary.
- Acoustical panel surfaces; fabric surface over 0.5”(13mm) thick fiber board.
- Panel surfaces may have the same fabric on both sides or a different fabric on each side.
- Panel thickness is 2”(51mm).
- Base raceway is 4”(102mm)H.
- Shipped with unassembled top cap, base raceway cover and side trim rails.

Specification Tips

- Panels will accept add-on panels up to a combined height of 82”(2083mm). For aesthetic consistency, specify UniGroup add-on panels.
- Raceway cover must be separately specified for option -BE (no raceway cover).
- Additional base raceway cover end caps will need to be specified if finish posts are not ordered.

To Order, Specify:

1) Product number, including:

1 Options:

B With Raceway Cover

BE Without Raceway Cover
(deduct **\$119.67** list)

- 2) Fabric/colorway for panel side one.
- 3) Fabric/colorway for panel side two.
- 4) Trim color for raceway cover, glide housings and end caps. Not available in metallic trim colors.
- 5) Trim color for top cap and side trim rails.

Note: Upcharge for mixed surface grades, refer to the electronic design and specification tools for pricing.

Notes:

- Non-powered panels ship without receptacle ports in the base raceway cover.
- Some building codes may restrict the use of panel heights greater than 69”(1753mm). Consult your local code authority to assure that the furniture layout is compliant.
- For International Power, specify non-powered panels and use Power Logic components. See Specification Guide for more information on Power Logic.

Monolithic Panel with Steel Top Cap — No Power

UniGroup

Actual Height	Width	Number ①	Fabric					
			A	B	C	E	F	G
30"(762mm)	12"(305mm)	EFN-128- [] []	\$ 1174.62	\$ 1223.40	\$ 1277.08	\$ 1394.12	\$ 1472.14	\$ 1520.94
	18"(457mm)	EFN-1828- [] []	1311.96	1377.06	1448.98	1605.26	1709.68	1775.16
	24"(610mm)	EFN-228- [] []	1449.30	1530.72	1620.88	1816.40	1947.22	2029.38
	30"(762mm)	EFN-3028- [] []	1586.64	1684.38	1792.78	2027.54	2184.76	2283.60
	36"(914mm)	EFN-328- [] []	1773.98	1888.04	2014.68	2288.68	2472.30	2587.82
	42"(1067mm)	EFN-4228- [] []	1911.32	2041.70	2186.58	2499.82	2709.84	2842.04
	48"(1219mm)	EFN-428- [] []	2048.66	2195.36	2358.48	2710.96	2947.38	3096.26
	54"(1372mm)	EFN-5428- [] []	2186.00	2349.02	2530.38	2922.10	3184.92	3350.48
60"(1524mm)	EFN-528- [] []	2323.34	2502.68	2702.28	3133.24	3422.46	3604.70	
37"(940mm)	12"(305mm)	EFN-135- [] []	\$ 1248.68	\$ 1308.10	\$ 1373.26	\$ 1515.36	\$ 1610.18	\$ 1669.20
	18"(457mm)	EFN-1835- [] []	1386.02	1461.76	1545.16	1726.50	1847.72	1923.42
	24"(610mm)	EFN-235- [] []	1523.36	1615.42	1717.06	1937.64	2085.26	2177.64
	30"(762mm)	EFN-3035- [] []	1660.70	1769.08	1888.96	2148.78	2322.80	2431.86
	36"(914mm)	EFN-335- [] []	1848.04	1972.74	2110.86	2409.92	2610.34	2736.08
	42"(1067mm)	EFN-4235- [] []	1985.38	2126.40	2282.76	2621.06	2847.88	2990.30
	48"(1219mm)	EFN-435- [] []	2122.72	2280.06	2454.66	2832.20	3085.42	3244.52
	54"(1372mm)	EFN-5435- [] []	2260.06	2433.72	2626.56	3043.34	3322.96	3498.74
60"(1524mm)	EFN-535- [] []	2397.40	2587.38	2798.46	3254.48	3560.50	3752.96	
44"(1118mm)	12"(305mm)	EFN-142- [] []	\$ 1322.74	\$ 1392.80	\$ 1469.44	\$ 1636.60	\$ 1748.22	\$ 1817.46
	18"(457mm)	EFN-1842- [] []	1460.08	1546.46	1641.34	1847.74	1985.76	2071.68
	24"(610mm)	EFN-242- [] []	1597.42	1700.12	1813.24	2058.88	2223.30	2325.90
	30"(762mm)	EFN-3042- [] []	1734.76	1853.78	1985.14	2270.02	2460.84	2580.12
	36"(914mm)	EFN-342- [] []	1922.10	2057.44	2207.04	2531.16	2748.38	2884.34
	42"(1067mm)	EFN-4242- [] []	2059.44	2211.10	2378.94	2742.30	2985.92	3138.56
	48"(1219mm)	EFN-442- [] []	2196.78	2364.76	2550.84	2953.44	3223.46	3392.78
	54"(1372mm)	EFN-5442- [] []	2334.12	2518.42	2722.74	3164.58	3461.00	3647.00
60"(1524mm)	EFN-542- [] []	2471.46	2672.08	2894.64	3375.72	3698.54	3901.22	
50"(1270mm)	12"(305mm)	EFN-148- [] []	\$ 1386.22	\$ 1465.40	\$ 1551.88	\$ 1740.52	\$ 1866.54	\$ 1944.54
	18"(457mm)	EFN-1848- [] []	1523.56	1619.06	1723.78	1951.66	2104.08	2198.76
	24"(610mm)	EFN-248- [] []	1660.90	1772.72	1895.68	2162.80	2341.62	2452.98
	30"(762mm)	EFN-3048- [] []	1798.24	1926.38	2067.58	2373.94	2579.16	2707.20
	36"(914mm)	EFN-348- [] []	1985.58	2130.04	2289.48	2635.08	2866.70	3011.42
	42"(1067mm)	EFN-4248- [] []	2122.92	2283.70	2461.38	2846.22	3104.24	3265.64
	48"(1219mm)	EFN-448- [] []	2260.26	2437.36	2633.28	3057.36	3341.78	3519.86
	54"(1372mm)	EFN-5448- [] []	2397.60	2591.02	2805.18	3268.50	3579.32	3774.08
60"(1524mm)	EFN-548- [] []	2534.94	2744.68	2977.08	3479.64	3816.86	4028.30	

Monolithic Panel with Steel Top Cap — No Power

UniGroup

Actual Height	Width	Number ①	Fabric					
			A	B	C	E	F	G
56"(1422mm)	12"(305mm)	EFN-154-■ ■	\$ 1449.70	\$ 1538.00	\$ 1634.32	\$ 1844.44	\$ 1984.86	\$ 2071.62
	18"(457mm)	EFN-1854-■ ■	1587.04	1691.66	1806.22	2055.58	2222.40	2325.84
	24"(610mm)	EFN-254-■ ■	1724.38	1845.32	1978.12	2266.72	2459.94	2580.06
	30"(762mm)	EFN-3054-■ ■	1861.72	1998.98	2150.02	2477.86	2697.48	2834.28
	36"(914mm)	EFN-354-■ ■	2049.06	2202.64	2371.92	2739.00	2985.02	3138.50
	42"(1067mm)	EFN-4254-■ ■	2186.40	2356.30	2543.82	2950.14	3222.56	3392.72
	48"(1219mm)	EFN-454-■ ■	2323.74	2509.96	2715.72	3161.28	3460.10	3646.94
	54"(1372mm)	EFN-5454-■ ■	2461.08	2663.62	2887.62	3372.42	3697.64	3901.16
60"(1524mm)	EFN-554-■ ■	2598.42	2817.28	3059.52	3583.56	3935.18	4155.38	
64"(1626mm)	12"(305mm)	EFN-162-■ ■	\$ 1579.34	\$ 1679.80	\$ 1789.24	\$ 2028.00	\$ 2187.62	\$ 2286.06
	18"(457mm)	EFN-1862-■ ■	1716.68	1833.46	1961.14	2239.14	2425.16	2540.28
	24"(610mm)	EFN-262-■ ■	1854.02	1987.12	2133.04	2450.28	2662.70	2794.50
	30"(762mm)	EFN-3062-■ ■	1991.36	2140.78	2304.94	2661.42	2900.24	3048.72
	36"(914mm)	EFN-362-■ ■	2178.70	2344.44	2526.84	2922.56	3187.78	3352.94
	42"(1067mm)	EFN-4262-■ ■	2316.04	2498.10	2698.74	3133.70	3425.32	3607.16
	48"(1219mm)	EFN-462-■ ■	2453.38	2651.76	2870.64	3344.84	3662.86	3861.38
	54"(1372mm)	EFN-5462-■ ■	2590.72	2805.42	3042.54	3555.98	3900.40	4115.60
60"(1524mm)	EFN-562-■ ■	2728.06	2959.08	3214.44	3767.12	4137.94	4369.82	
68"(1727mm)	12"(305mm)	EFN-166-■ ■	\$ 1621.66	\$ 1728.20	\$ 1844.20	\$ 2097.28	\$ 2266.50	\$ 2370.78
	18"(457mm)	EFN-1866-■ ■	1759.00	1881.86	2016.10	2308.42	2504.04	2625.00
	24"(610mm)	EFN-266-■ ■	1896.34	2035.52	2188.00	2519.56	2741.58	2879.22
	30"(762mm)	EFN-3066-■ ■	2033.68	2189.18	2359.90	2730.70	2979.12	3133.44
	36"(914mm)	EFN-366-■ ■	2221.02	2392.84	2581.80	2991.84	3266.66	3437.66
	42"(1067mm)	EFN-4266-■ ■	2358.36	2546.50	2753.70	3202.98	3504.20	3691.88
	48"(1219mm)	EFN-466-■ ■	2495.70	2700.16	2925.60	3414.12	3741.74	3946.10
	54"(1372mm)	EFN-5466-■ ■	2633.04	2853.82	3097.50	3625.26	3979.28	4200.32
60"(1524mm)	EFN-566-■ ■	2770.38	3007.48	3269.40	3836.40	4216.82	4454.54	
82"(2083mm)	12"(305mm)	EFN-180-■ ■	\$ 1793.84	\$ 1921.66	\$ 2060.62	\$ 2363.82	\$ 2566.64	\$ 2691.36
	18"(457mm)	EFN-1880-■ ■	2012.90	2157.04	2314.24	2656.68	2885.90	3027.30
	24"(610mm)	EFN-280-■ ■	2231.96	2392.42	2567.86	2949.54	3205.16	3363.24
	30"(762mm)	EFN-3080-■ ■	2451.02	2627.80	2821.48	3242.40	3524.42	3699.18
	36"(914mm)	EFN-380-■ ■	2720.08	2913.18	3125.10	3585.26	3893.68	4085.12
	42"(1067mm)	EFN-4280-■ ■	2939.14	3148.56	3378.72	3878.12	4212.94	4421.06
	48"(1219mm)	EFN-480-■ ■	3158.20	3383.94	3632.34	4170.98	4532.20	4757.00
	54"(1372mm)	EFN-5480-■ ■	3377.26	3619.32	3885.96	4463.84	4851.46	5092.94
60"(1524mm)	EFN-580-■ ■	3596.32	3854.70	4139.58	4756.70	5170.72	5428.88	

Monolithic Panel with Steel Top Cap — Powered UniGroup

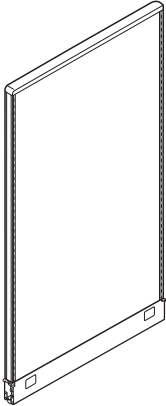

EFP-B (3-circuit)
Class AA



Note: This panel has fabric/colorway restrictions, see Systems Fabric/ Color Legend.

Features

- Includes powered panel assembly, radius steel top cap, with or without one-piece base raceway cover, 1.6 hinge kits, side trim rails, leveling glides and carpet gripper; power distribution assembly/flex connector(s). .6 base raceway end caps are shipped with each panel. Order additional as necessary.
- Acoustical panel surfaces; fabric surface over 0.5”(13mm) thick fiber board.
- Panel surfaces may have the same fabric on both sides or a different fabric on each side.
- Panel thickness is 2”(51mm).
- Base raceway is 4”(102mm)H.
- Powered raceway with or without raceway cover requires modified catalog number and list price.
- Powered panels are available for countries that utilize 120 volt 60 hertz electrical systems and U.S. configured plugs and outlets.
- Shipped with unassembled top cap, base raceway cover and side trim rails.

Specification Tips

- Panels will accept add-on panels up to a combined height of 82”(2083mm). For aesthetic consistency, specify UniGroup add-on panels.
- Flex connectors provided for powered monolithic panels accommodate straight in-line, inside 90°, and inside 120° conditions (if applicable).
- Receptacles for powered panels must be specified separately.
- Raceway cover must be separately specified for option -BE or BYE (no raceway cover).
- Additional base raceway cover end caps will need to be specified if finish posts are not ordered.

To Order, Specify:

1) Product number, including:

1 3-Circuit

B With Raceway Cover

BE Without Raceway Cover
(deduct **\$119.67** list)

BY NYC with Raceway Cover
(add **\$80.16** list)

BYE NYC without Raceway Cover
(deduct **\$39.51** list)

- 2) Fabric/colorway for panel side one.
- 3) Fabric/colorway for panel side two.
- 4) Trim color for raceway cover, glide housings and end caps. Not available in metallic trim colors.
- 5) Trim color for top cap and side trim rails.

Note: Upcharge for mixed surface grades, refer to the electronic design and specification tools for pricing.

Notes:

- Powered panels with raceway covers ship with receptacle ports in the base raceway cover. Receptacle ports on the raceway cover measure 2.35”(60mm) top-to-bottom and 2.88”(73mm) side-to-side.
- Powered panels with Power Distribution Assemblies (PDA) but without raceway covers require separately specified base raceway covers for power and communication port locations other than the standard powered base raceway cover.
- New York City (NYC) electrical applications require field installation of PDA.
- New York Port Authority (NYPA) electrical applications require metal raceway covers. To order, specify NYC powered panels without raceway cover and separately specify metal covers through Haworth eParts.
- Some building codes may restrict the use of panel heights greater than 69”(1753mm). Consult your local code authority to assure that the furniture layout is compliant.
- For International Power, specify non-powered panels and use Power Logic components. See Specification Guide for more information on Power Logic.
- For Chicago power, specify non-powered panels without a base raceway cover and separately specify Chicago power retrofit kit.

Monolithic Panel with Steel Top Cap — Powered UniGroup

Actual Height	Width	Number ①	Fabric					
			A	B	C	E	F	G
30"(762mm)	12"(305mm)	EFP-128-■ ■	\$ 1529.13	\$ 1577.91	\$ 1631.59	\$ 1748.63	\$ 1826.65	\$ 1875.45
	18"(457mm)	EFP-1828-■ ■	1681.86	1746.96	1818.88	1975.16	2079.58	2145.06
	24"(610mm)	EFP-228-■ ■	1819.20	1900.62	1990.78	2186.30	2317.12	2399.28
	30"(762mm)	EFP-3028-■ ■	1956.54	2054.28	2162.68	2397.44	2554.66	2653.50
	36"(914mm)	EFP-328-■ ■	2143.88	2257.94	2384.58	2658.58	2842.20	2957.72
	42"(1067mm)	EFP-4228-■ ■	2281.22	2411.60	2556.48	2869.72	3079.74	3211.94
	48"(1219mm)	EFP-428-■ ■	2418.56	2565.26	2728.38	3080.86	3317.28	3466.16
	54"(1372mm)	EFP-5428-■ ■	2555.90	2718.92	2900.28	3292.00	3554.82	3720.38
60"(1524mm)	EFP-528-■ ■	2693.24	2872.58	3072.18	3503.14	3792.36	3974.60	
37"(940mm)	12"(305mm)	EFP-135-■ ■	\$ 1603.19	\$ 1662.61	\$ 1727.77	\$ 1869.87	\$ 1964.69	\$ 2023.71
	18"(457mm)	EFP-1835-■ ■	1755.92	1831.66	1915.06	2096.40	2217.62	2293.32
	24"(610mm)	EFP-235-■ ■	1893.26	1985.32	2086.96	2307.54	2455.16	2547.54
	30"(762mm)	EFP-3035-■ ■	2030.60	2138.98	2258.86	2518.68	2692.70	2801.76
	36"(914mm)	EFP-335-■ ■	2217.94	2342.64	2480.76	2779.82	2980.24	3105.98
	42"(1067mm)	EFP-4235-■ ■	2355.28	2496.30	2652.66	2990.96	3217.78	3360.20
	48"(1219mm)	EFP-435-■ ■	2492.62	2649.96	2824.56	3202.10	3455.32	3614.42
	54"(1372mm)	EFP-5435-■ ■	2629.96	2803.62	2996.46	3413.24	3692.86	3868.64
60"(1524mm)	EFP-535-■ ■	2767.30	2957.28	3168.36	3624.38	3930.40	4122.86	
44"(1118mm)	12"(305mm)	EFP-142-■ ■	\$ 1677.25	\$ 1747.31	\$ 1823.95	\$ 1991.11	\$ 2102.73	\$ 2171.97
	18"(457mm)	EFP-1842-■ ■	1829.98	1916.36	2011.24	2217.64	2355.66	2441.58
	24"(610mm)	EFP-242-■ ■	1967.32	2070.02	2183.14	2428.78	2593.20	2695.80
	30"(762mm)	EFP-3042-■ ■	2104.66	2223.68	2355.04	2639.92	2830.74	2950.02
	36"(914mm)	EFP-342-■ ■	2292.00	2427.34	2576.94	2901.06	3118.28	3254.24
	42"(1067mm)	EFP-4242-■ ■	2429.34	2581.00	2748.84	3112.20	3355.82	3508.46
	48"(1219mm)	EFP-442-■ ■	2566.68	2734.66	2920.74	3323.34	3593.36	3762.68
	54"(1372mm)	EFP-5442-■ ■	2704.02	2888.32	3092.64	3534.48	3830.90	4016.90
60"(1524mm)	EFP-542-■ ■	2841.36	3041.98	3264.54	3745.62	4068.44	4271.12	
50"(1270mm)	12"(305mm)	EFP-148-■ ■	\$ 1740.73	\$ 1819.91	\$ 1906.39	\$ 2095.03	\$ 2221.05	\$ 2299.05
	18"(457mm)	EFP-1848-■ ■	1893.46	1988.96	2093.68	2321.56	2473.98	2568.66
	24"(610mm)	EFP-248-■ ■	2030.80	2142.62	2265.58	2532.70	2711.52	2822.88
	30"(762mm)	EFP-3048-■ ■	2168.14	2296.28	2437.48	2743.84	2949.06	3077.10
	36"(914mm)	EFP-348-■ ■	2355.48	2499.94	2659.38	3004.98	3236.60	3381.32
	42"(1067mm)	EFP-4248-■ ■	2492.82	2653.60	2831.28	3216.12	3474.14	3635.54
	48"(1219mm)	EFP-448-■ ■	2630.16	2807.26	3003.18	3427.26	3711.68	3889.76
	54"(1372mm)	EFP-5448-■ ■	2767.50	2960.92	3175.08	3638.40	3949.22	4143.98
60"(1524mm)	EFP-548-■ ■	2904.84	3114.58	3346.98	3849.54	4186.76	4398.20	

Monolithic Panel with Steel Top Cap — Powered

UniGroup

Actual Height	Width	Number ①	Fabric					
			A	B	C	E	F	G
56"(1422mm)	12"(305mm)	EFP-154-■ ■	\$ 1804.21	\$ 1892.51	\$ 1988.83	\$ 2198.95	\$ 2339.37	\$ 2426.13
	18"(457mm)	EFP-1854-■ ■ ■	1956.94	2061.56	2176.12	2425.48	2592.30	2695.74
	24"(610mm)	EFP-254-■ ■	2094.28	2215.22	2348.02	2636.62	2829.84	2949.96
	30"(762mm)	EFP-3054-■ ■ ■	2231.62	2368.88	2519.92	2847.76	3067.38	3204.18
	36"(914mm)	EFP-354-■ ■	2418.96	2572.54	2741.82	3108.90	3354.92	3508.40
	42"(1067mm)	EFP-4254-■ ■ ■	2556.30	2726.20	2913.72	3320.04	3592.46	3762.62
	48"(1219mm)	EFP-454-■ ■	2693.64	2879.86	3085.62	3531.18	3830.00	4016.84
	54"(1372mm)	EFP-5454-■ ■ ■	2830.98	3033.52	3257.52	3742.32	4067.54	4271.06
60"(1524mm)	EFP-554-■ ■	2968.32	3187.18	3429.42	3953.46	4305.08	4525.28	
64"(1626mm)	12"(305mm)	EFP-162-■ ■	\$ 1933.85	\$ 2034.31	\$ 2143.75	\$ 2382.51	\$ 2542.13	\$ 2640.57
	18"(457mm)	EFP-1862-■ ■ ■	2086.58	2203.36	2331.04	2609.04	2795.06	2910.18
	24"(610mm)	EFP-262-■ ■	2223.92	2357.02	2502.94	2820.18	3032.60	3164.40
	30"(762mm)	EFP-3062-■ ■ ■	2361.26	2510.68	2674.84	3031.32	3270.14	3418.62
	36"(914mm)	EFP-362-■ ■	2548.60	2714.34	2896.74	3292.46	3557.68	3722.84
	42"(1067mm)	EFP-4262-■ ■ ■	2685.94	2868.00	3068.64	3503.60	3795.22	3977.06
	48"(1219mm)	EFP-462-■ ■	2823.28	3021.66	3240.54	3714.74	4032.76	4231.28
	54"(1372mm)	EFP-5462-■ ■ ■	2960.62	3175.32	3412.44	3925.88	4270.30	4485.50
60"(1524mm)	EFP-562-■ ■	3097.96	3328.98	3584.34	4137.02	4507.84	4739.72	
68"(1727mm)	12"(305mm)	EFP-166-■ ■	\$ 1976.17	\$ 2082.71	\$ 2198.71	\$ 2451.79	\$ 2621.01	\$ 2725.29
	18"(457mm)	EFP-1866-■ ■ ■	2128.90	2251.76	2386.00	2678.32	2873.94	2994.90
	24"(610mm)	EFP-266-■ ■	2266.24	2405.42	2557.90	2889.46	3111.48	3249.12
	30"(762mm)	EFP-3066-■ ■ ■	2403.58	2559.08	2729.80	3100.60	3349.02	3503.34
	36"(914mm)	EFP-366-■ ■	2590.92	2762.74	2951.70	3361.74	3636.56	3807.56
	42"(1067mm)	EFP-4266-■ ■ ■	2728.26	2916.40	3123.60	3572.88	3874.10	4061.78
	48"(1219mm)	EFP-466-■ ■	2865.60	3070.06	3295.50	3784.02	4111.64	4316.00
	54"(1372mm)	EFP-5466-■ ■ ■	3002.94	3223.72	3467.40	3995.16	4349.18	4570.22
60"(1524mm)	EFP-566-■ ■	3140.28	3377.38	3639.30	4206.30	4586.72	4824.44	
82"(2083mm)	12"(305mm)	EFP-180-■ ■	\$ 2148.35	\$ 2276.17	\$ 2415.13	\$ 2718.33	\$ 2921.15	\$ 3045.87
	18"(457mm)	EFP-1880-■ ■ ■	2382.80	2526.94	2684.14	3026.58	3255.80	3397.20
	24"(610mm)	EFP-280-■ ■	2601.86	2762.32	2937.76	3319.44	3575.06	3733.14
	30"(762mm)	EFP-3080-■ ■ ■	2820.92	2997.70	3191.38	3612.30	3894.32	4069.08
	36"(914mm)	EFP-380-■ ■	3089.98	3283.08	3495.00	3955.16	4263.58	4455.02
	42"(1067mm)	EFP-4280-■ ■ ■	3309.04	3518.46	3748.62	4248.02	4582.84	4790.96
	48"(1219mm)	EFP-480-■ ■	3528.10	3753.84	4002.24	4540.88	4902.10	5126.90
	54"(1372mm)	EFP-5480-■ ■ ■	3747.16	3989.22	4255.86	4833.74	5221.36	5462.84
60"(1524mm)	EFP-580-■ ■	3966.22	4224.60	4509.48	5126.60	5540.62	5798.78	

Basic Monolithic Panel with Steel Top Cap — No Power

UniGroup

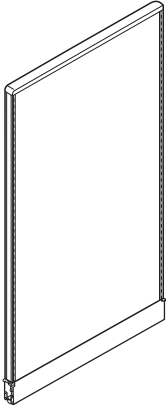

EMN-B (Non-Powered)
Class AA

Note: This panel has fabric/colorway restrictions, see Systems Fabric/ Color Legend.

Features

- Includes non-powered panel assembly, radius steel top cap, with or without one-piece base raceway cover, 1.6 hinge kits, side trim rails, leveling glides and carpet gripper. **.6** base raceway end caps are shipped with each panel. Order additional as necessary.
- Acoustical panel surfaces; fabric surface over 0.25”(6mm) thick fiber board.
- Panel surfaces may have the same fabric on both sides or a different fabric on each side.
- Panel thickness is 2”(51mm).
- Shipped with unassembled top cap, base raceway cover and side trim rails.

Specification Tips

- Panels will accept add-on panels up to a combined height of 82”(2083mm). For aesthetic consistency, specify UniGroup add-on panels.
- Raceway cover must be separately specified for option -BE (no raceway cover).
- Additional base raceway cover end caps will need to be specified if finish posts are not ordered.

To Order, Specify:

1) Product number, including:

1 Options:

B With Raceway Cover

BE Without Raceway Cover
(deduct **\$119.67** list)

- 2) Fabric/colorway for panel side one.
- 3) Fabric/colorway for panel side two.
- 4) Trim color for raceway cover, glide housings and end caps. Not available in metallic trim colors.
- 5) Trim color for top cap and side trim rails.

Note: Upcharge for mixed surface grades, refer to the electronic design and specification tools for pricing.

Notes:

- Non-powered panels ship without receptacle ports in the base raceway cover.
- Some building codes may restrict the use of panel heights greater than 69”(1753mm). Consult your local code authority to assure that the furniture layout is compliant.
- For International Power, specify non-powered panels and use Power Logic components. See Specification Guide for more information on Power Logic.
- For Chicago power, specify non-powered panels without a base raceway cover and separately specify Chicago power retrofit kit.

Basic Monolithic Panel with Steel Top Cap — No Power

UniGroup

Actual Height	Width	Number ①	Fabric					
			A	B	C	E	F	G
30"(762mm)	12"(305mm)	EMN-128-	\$ 1070.25	\$ 1119.03	\$ 1172.71	\$ 1289.75	\$ 1367.77	\$ 1416.57
	18"(457mm)	EMN-1828-	1178.73	1243.83	1315.75	1472.03	1576.45	1641.93
	24"(610mm)	EMN-228-	1287.21	1368.63	1458.79	1654.31	1785.13	1867.29
	30"(762mm)	EMN-3028-	1395.69	1493.43	1601.83	1836.59	1993.81	2092.65
	36"(914mm)	EMN-328-	1554.17	1668.23	1794.87	2068.87	2252.49	2368.01
	42"(1067mm)	EMN-4228-	1662.65	1793.03	1937.91	2251.15	2461.17	2593.37
	48"(1219mm)	EMN-428-	1771.13	1917.83	2080.95	2433.43	2669.85	2818.73
	54"(1372mm)	EMN-5428-	1879.61	2042.63	2223.99	2615.71	2878.53	3044.09
60"(1524mm)	EMN-528-	1988.09	2167.43	2367.03	2797.99	3087.21	3269.45	
37"(940mm)	12"(305mm)	EMN-135-	\$ 1138.71	\$ 1198.13	\$ 1263.29	\$ 1405.39	\$ 1500.21	\$ 1559.23
	18"(457mm)	EMN-1835-	1247.19	1322.93	1406.33	1587.67	1708.89	1784.59
	24"(610mm)	EMN-235-	1355.67	1447.73	1549.37	1769.95	1917.57	2009.95
	30"(762mm)	EMN-3035-	1464.15	1572.53	1692.41	1952.23	2126.25	2235.31
	36"(914mm)	EMN-335-	1622.63	1747.33	1885.45	2184.51	2384.93	2510.67
	42"(1067mm)	EMN-4235-	1731.11	1872.13	2028.49	2366.79	2593.61	2736.03
	48"(1219mm)	EMN-435-	1839.59	1996.93	2171.53	2549.07	2802.29	2961.39
	54"(1372mm)	EMN-5435-	1948.07	2121.73	2314.57	2731.35	3010.97	3186.75
60"(1524mm)	EMN-535-	2056.55	2246.53	2457.61	2913.63	3219.65	3412.11	
44"(1118mm)	12"(305mm)	EMN-142-	\$ 1207.17	\$ 1277.23	\$ 1353.87	\$ 1521.03	\$ 1632.65	\$ 1701.89
	18"(457mm)	EMN-1842-	1315.65	1402.03	1496.91	1703.31	1841.33	1927.25
	24"(610mm)	EMN-242-	1424.13	1526.83	1639.95	1885.59	2050.01	2152.61
	30"(762mm)	EMN-3042-	1532.61	1651.63	1782.99	2067.87	2258.69	2377.97
	36"(914mm)	EMN-342-	1691.09	1826.43	1976.03	2300.15	2517.37	2653.33
	42"(1067mm)	EMN-4242-	1799.57	1951.23	2119.07	2482.43	2726.05	2878.69
	48"(1219mm)	EMN-442-	1908.05	2076.03	2262.11	2664.71	2934.73	3104.05
	54"(1372mm)	EMN-5442-	2016.53	2200.83	2405.15	2846.99	3143.41	3329.41
60"(1524mm)	EMN-542-	2125.01	2325.63	2548.19	3029.27	3352.09	3554.77	
50"(1270mm)	12"(305mm)	EMN-148-	\$ 1265.85	\$ 1345.03	\$ 1431.51	\$ 1620.15	\$ 1746.17	\$ 1824.17
	18"(457mm)	EMN-1848-	1374.33	1469.83	1574.55	1802.43	1954.85	2049.53
	24"(610mm)	EMN-248-	1482.81	1594.63	1717.59	1984.71	2163.53	2274.89
	30"(762mm)	EMN-3048-	1591.29	1719.43	1860.63	2166.99	2372.21	2500.25
	36"(914mm)	EMN-348-	1749.77	1894.23	2053.67	2399.27	2630.89	2775.61
	42"(1067mm)	EMN-4248-	1858.25	2019.03	2196.71	2581.55	2839.57	3000.97
	48"(1219mm)	EMN-448-	1966.73	2143.83	2339.75	2763.83	3048.25	3226.33
	54"(1372mm)	EMN-5448-	2075.21	2268.63	2482.79	2946.11	3256.93	3451.69
60"(1524mm)	EMN-548-	2183.69	2393.43	2625.83	3128.39	3465.61	3677.05	

Basic Monolithic Panel with Steel Top Cap — No Power

UniGroup

Actual Height	Width	Number ①	Fabric					
			A	B	C	E	F	G
56"(1422mm)	12"(305mm)	EMN-154-	\$ 1324.53	\$ 1412.83	\$ 1509.15	\$ 1719.27	\$ 1859.69	\$ 1946.45
	18"(457mm)	EMN-1854-	1433.01	1537.63	1652.19	1901.55	2068.37	2171.81
	24"(610mm)	EMN-254-	1541.49	1662.43	1795.23	2083.83	2277.05	2397.17
	30"(762mm)	EMN-3054-	1649.97	1787.23	1938.27	2266.11	2485.73	2622.53
	36"(914mm)	EMN-354-	1808.45	1962.03	2131.31	2498.39	2744.41	2897.89
	42"(1067mm)	EMN-4254-	1916.93	2086.83	2274.35	2680.67	2953.09	3123.25
	48"(1219mm)	EMN-454-	2025.41	2211.63	2417.39	2862.95	3161.77	3348.61
	54"(1372mm)	EMN-5454-	2133.89	2336.43	2560.43	3045.23	3370.45	3573.97
60"(1524mm)	EMN-554-	2242.37	2461.23	2703.47	3227.51	3579.13	3799.33	
64"(1626mm)	12"(305mm)	EMN-162-	\$ 1447.77	\$ 1548.23	\$ 1657.67	\$ 1896.43	\$ 2056.05	\$ 2154.49
	18"(457mm)	EMN-1862-	1556.25	1673.03	1800.71	2078.71	2264.73	2379.85
	24"(610mm)	EMN-262-	1664.73	1797.83	1943.75	2260.99	2473.41	2605.21
	30"(762mm)	EMN-3062-	1773.21	1922.63	2086.79	2443.27	2682.09	2830.57
	36"(914mm)	EMN-362-	1931.69	2097.43	2279.83	2675.55	2940.77	3105.93
	42"(1067mm)	EMN-4262-	2040.17	2222.23	2422.87	2857.83	3149.45	3331.29
	48"(1219mm)	EMN-462-	2148.65	2347.03	2565.91	3040.11	3358.13	3556.65
	54"(1372mm)	EMN-5462-	2257.13	2471.83	2708.95	3222.39	3566.81	3782.01
60"(1524mm)	EMN-562-	2365.61	2596.63	2851.99	3404.67	3775.49	4007.37	
68"(1727mm)	12"(305mm)	EMN-166-	\$ 1486.89	\$ 1593.43	\$ 1709.43	\$ 1962.51	\$ 2131.73	\$ 2236.01
	18"(457mm)	EMN-1866-	1595.37	1718.23	1852.47	2144.79	2340.41	2461.37
	24"(610mm)	EMN-266-	1703.85	1843.03	1995.51	2327.07	2549.09	2686.73
	30"(762mm)	EMN-3066-	1812.33	1967.83	2138.55	2509.35	2757.77	2912.09
	36"(914mm)	EMN-366-	1970.81	2142.63	2331.59	2741.63	3016.45	3187.45
	42"(1067mm)	EMN-4266-	2079.29	2267.43	2474.63	2923.91	3225.13	3412.81
	48"(1219mm)	EMN-466-	2187.77	2392.23	2617.67	3106.19	3433.81	3638.17
	54"(1372mm)	EMN-5466-	2296.25	2517.03	2760.71	3288.47	3642.49	3863.53
60"(1524mm)	EMN-566-	2404.73	2641.83	2903.75	3470.75	3851.17	4088.89	
82"(2083mm)	12"(305mm)	EMN-180-	\$ 1647.87	\$ 1775.69	\$ 1914.65	\$ 2217.85	\$ 2420.67	\$ 2545.39
	18"(457mm)	EMN-1880-	1838.07	1982.21	2139.41	2481.85	2711.07	2852.47
	24"(610mm)	EMN-280-	2028.27	2188.73	2364.17	2745.85	3001.47	3159.55
	30"(762mm)	EMN-3080-	2218.47	2395.25	2588.93	3009.85	3291.87	3466.63
	36"(914mm)	EMN-380-	2458.67	2651.77	2863.69	3323.85	3632.27	3823.71
	42"(1067mm)	EMN-4280-	2648.87	2858.29	3088.45	3587.85	3922.67	4130.79
	48"(1219mm)	EMN-480-	2839.07	3064.81	3313.21	3851.85	4213.07	4437.87
	54"(1372mm)	EMN-5480-	3029.27	3271.33	3537.97	4115.85	4503.47	4744.95
60"(1524mm)	EMN-580-	3219.47	3477.85	3762.73	4379.85	4793.87	5052.03	

Basic Monolithic Panel with Steel Top Cap — Powered UniGroup

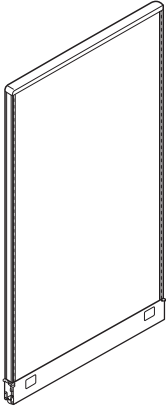

EMP-B (3-circuit)
Class AA



Note: This panel has fabric/colorway restrictions, see Systems Fabric/ Color Legend.

Features

- Includes powered panel assembly, radius steel top cap, with or without one-piece base raceway cover, 1.6 hinge kits, side trim rails, leveling glides and carpet gripper; power distribution assembly/flex connector(s). .6 base raceway end caps are shipped with each panel. Order additional as necessary.
- Acoustical panel surfaces; fabric surface over 0.25”(6mm) thick fiber board.
- Panel surfaces may have the same fabric on both sides or a different fabric on each side.
- Panel thickness is 2”(51mm).
- Base raceway is 4”(102mm)H.
- Powered raceway with or without raceway cover requires modified catalog number and list price.
- Powered panels are available for countries that utilize 120 volt 60 hertz electrical systems and U.S. configured plugs and outlets.
- Shipped with unassembled top cap, base raceway cover and side trim rails.

Specification Tips

- Panels will accept add-on panels up to a combined height of 82”(2083mm). For aesthetic consistency, specify UniGroup add-on panels.
- Flex connectors provided for powered monolithic panels accommodate straight in-line, inside 90°, and inside 120° conditions (if applicable).
- Receptacles for powered panels must be specified separately.
- Raceway cover must be separately specified for option -BE or BYE (no raceway cover).
- Additional base raceway cover end caps will need to be specified if finish posts are not ordered.

To Order, Specify:

1) Product number, including:

1 3-Circuit

B With Raceway Cover

BE Without Raceway Cover (deduct **\$119.67** list)

BY NYC with Raceway Cover (add **\$80.16** list)

BYE NYC without Raceway Cover (deduct **\$39.51** list)

- 2) Fabric/colorway for panel side one.
- 3) Fabric/colorway for panel side two.
- 4) Trim color for raceway cover, glide housings and end caps. Not available in metallic trim colors.
- 5) Trim color for top cap and side trim rails.

Note: Upcharge for mixed surface grades, refer to the electronic design and specification tools for pricing.

Notes:

- Powered panels with raceway covers ship with receptacle ports in the base raceway cover. Receptacle ports on the raceway cover measure 2.35”(60mm) top-to-bottom and 2.88”(73mm) side-to-side.
- Powered panels with Power Distribution Assemblies (PDA) but without raceway covers require separately specified base raceway covers for power and communication port locations other than the standard powered base raceway cover.
- New York City (NYC) electrical applications require field installation of PDA.
- New York Port Authority (NYPA) electrical applications require metal raceway covers. To order, specify NYC powered panels without raceway cover and separately specify metal covers through Haworth eParts.
- Some building codes may restrict the use of panel heights greater than 69”(1753mm). Consult your local code authority to assure that the furniture layout is compliant.
- For International Power, specify non-powered panels and use Power Logic components. See Specification Guide for more information on Power Logic.
- For Chicago power, specify non-powered panels without a base raceway cover and separately specify Chicago power retrofit kit.

Basic Monolithic Panel with Steel Top Cap — Powered UniGroup

Actual Height	Width	Number ①	Fabric					
			A	B	C	E	F	G
30"(762mm)	12"(305mm)	EMP-128- ■ ■	\$ 1424.76	\$ 1473.54	\$ 1527.22	\$ 1644.26	\$ 1722.28	\$ 1771.08
	18"(457mm)	EMP-1828- ■ ■	1548.63	1613.73	1685.65	1841.93	1946.35	2011.83
	24"(610mm)	EMP-228- ■ ■	1657.11	1738.53	1828.69	2024.21	2155.03	2237.19
	30"(762mm)	EMP-3028- ■ ■	1765.59	1863.33	1971.73	2206.49	2363.71	2462.55
	36"(914mm)	EMP-328- ■ ■	1924.07	2038.13	2164.77	2438.77	2622.39	2737.91
	42"(1067mm)	EMP-4228- ■ ■	2032.55	2162.93	2307.81	2621.05	2831.07	2963.27
	48"(1219mm)	EMP-428- ■ ■	2141.03	2287.73	2450.85	2803.33	3039.75	3188.63
	54"(1372mm)	EMP-5428- ■ ■	2249.51	2412.53	2593.89	2985.61	3248.43	3413.99
60"(1524mm)	EMP-528- ■ ■	2357.99	2537.33	2736.93	3167.89	3457.11	3639.35	
37"(940mm)	12"(305mm)	EMP-135- ■ ■	\$ 1493.22	\$ 1552.64	\$ 1617.80	\$ 1759.90	\$ 1854.72	\$ 1913.74
	18"(457mm)	EMP-1835- ■ ■	1617.09	1692.83	1776.23	1957.57	2078.79	2154.49
	24"(610mm)	EMP-235- ■ ■	1725.57	1817.63	1919.27	2139.85	2287.47	2379.85
	30"(762mm)	EMP-3035- ■ ■	1834.05	1942.43	2062.31	2322.13	2496.15	2605.21
	36"(914mm)	EMP-335- ■ ■	1992.53	2117.23	2255.35	2554.41	2754.83	2880.57
	42"(1067mm)	EMP-4235- ■ ■	2101.01	2242.03	2398.39	2736.69	2963.51	3105.93
	48"(1219mm)	EMP-435- ■ ■	2209.49	2366.83	2541.43	2918.97	3172.19	3331.29
	54"(1372mm)	EMP-5435- ■ ■	2317.97	2491.63	2684.47	3101.25	3380.87	3556.65
60"(1524mm)	EMP-535- ■ ■	2426.45	2616.43	2827.51	3283.53	3589.55	3782.01	
44"(1118mm)	12"(305mm)	EMP-142- ■ ■	\$ 1561.68	\$ 1631.74	\$ 1708.38	\$ 1875.54	\$ 1987.16	\$ 2056.40
	18"(457mm)	EMP-1842- ■ ■	1685.55	1771.93	1866.81	2073.21	2211.23	2297.15
	24"(610mm)	EMP-242- ■ ■	1794.03	1896.73	2009.85	2255.49	2419.91	2522.51
	30"(762mm)	EMP-3042- ■ ■	1902.51	2021.53	2152.89	2437.77	2628.59	2747.87
	36"(914mm)	EMP-342- ■ ■	2060.99	2196.33	2345.93	2670.05	2887.27	3023.23
	42"(1067mm)	EMP-4242- ■ ■	2169.47	2321.13	2488.97	2852.33	3095.95	3248.59
	48"(1219mm)	EMP-442- ■ ■	2277.95	2445.93	2632.01	3034.61	3304.63	3473.95
	54"(1372mm)	EMP-5442- ■ ■	2386.43	2570.73	2775.05	3216.89	3513.31	3699.31
60"(1524mm)	EMP-542- ■ ■	2494.91	2695.53	2918.09	3399.17	3721.99	3924.67	
50"(1270mm)	12"(305mm)	EMP-148- ■ ■	\$ 1620.36	\$ 1699.54	\$ 1786.02	\$ 1974.66	\$ 2100.68	\$ 2178.68
	18"(457mm)	EMP-1848- ■ ■	1744.23	1839.73	1944.45	2172.33	2324.75	2419.43
	24"(610mm)	EMP-248- ■ ■	1852.71	1964.53	2087.49	2354.61	2533.43	2644.79
	30"(762mm)	EMP-3048- ■ ■	1961.19	2089.33	2230.53	2536.89	2742.11	2870.15
	36"(914mm)	EMP-348- ■ ■	2119.67	2264.13	2423.57	2769.17	3000.79	3145.51
	42"(1067mm)	EMP-4248- ■ ■	2228.15	2388.93	2566.61	2951.45	3209.47	3370.87
	48"(1219mm)	EMP-448- ■ ■	2336.63	2513.73	2709.65	3133.73	3418.15	3596.23
	54"(1372mm)	EMP-5448- ■ ■	2445.11	2638.53	2852.69	3316.01	3626.83	3821.59
60"(1524mm)	EMP-548- ■ ■	2553.59	2763.33	2995.73	3498.29	3835.51	4046.95	

Basic Monolithic Panel with Steel Top Cap — Powered UniGroup

Actual Height	Width	Number ①	Fabric					
			A	B	C	E	F	G
56"(1422mm)	12"(305mm)	EMP-154- ■■	\$ 1679.04	\$ 1767.34	\$ 1863.66	\$ 2073.78	\$ 2214.20	\$ 2300.96
	18"(457mm)	EMP-1854- ■■	1802.91	1907.53	2022.09	2271.45	2438.27	2541.71
	24"(610mm)	EMP-254- ■■	1911.39	2032.33	2165.13	2453.73	2646.95	2767.07
	30"(762mm)	EMP-3054- ■■	2019.87	2157.13	2308.17	2636.01	2855.63	2992.43
	36"(914mm)	EMP-354- ■■	2178.35	2331.93	2501.21	2868.29	3114.31	3267.79
	42"(1067mm)	EMP-4254- ■■	2286.83	2456.73	2644.25	3050.57	3322.99	3493.15
	48"(1219mm)	EMP-454- ■■	2395.31	2581.53	2787.29	3232.85	3531.67	3718.51
	54"(1372mm)	EMP-5454- ■■	2503.79	2706.33	2930.33	3415.13	3740.35	3943.87
60"(1524mm)	EMP-554- ■■	2612.27	2831.13	3073.37	3597.41	3949.03	4169.23	
64"(1626mm)	12"(305mm)	EMP-162- ■■	\$ 1802.28	\$ 1902.74	\$ 2012.18	\$ 2250.94	\$ 2410.56	\$ 2509.00
	18"(457mm)	EMP-1862- ■■	1926.15	2042.93	2170.61	2448.61	2634.63	2749.75
	24"(610mm)	EMP-262- ■■	2034.63	2167.73	2313.65	2630.89	2843.31	2975.11
	30"(762mm)	EMP-3062- ■■	2143.11	2292.53	2456.69	2813.17	3051.99	3200.47
	36"(914mm)	EMP-362- ■■	2301.59	2467.33	2649.73	3045.45	3310.67	3475.83
	42"(1067mm)	EMP-4262- ■■	2410.07	2592.13	2792.77	3227.73	3519.35	3701.19
	48"(1219mm)	EMP-462- ■■	2518.55	2716.93	2935.81	3410.01	3728.03	3926.55
	54"(1372mm)	EMP-5462- ■■	2627.03	2841.73	3078.85	3592.29	3936.71	4151.91
60"(1524mm)	EMP-562- ■■	2735.51	2966.53	3221.89	3774.57	4145.39	4377.27	
68"(1727mm)	12"(305mm)	EMP-166- ■■	\$ 1841.40	\$ 1947.94	\$ 2063.94	\$ 2317.02	\$ 2486.24	\$ 2590.52
	18"(457mm)	EMP-1866- ■■	1965.27	2088.13	2222.37	2514.69	2710.31	2831.27
	24"(610mm)	EMP-266- ■■	2073.75	2212.93	2365.41	2696.97	2918.99	3056.63
	30"(762mm)	EMP-3066- ■■	2182.23	2337.73	2508.45	2879.25	3127.67	3281.99
	36"(914mm)	EMP-366- ■■	2340.71	2512.53	2701.49	3111.53	3386.35	3557.35
	42"(1067mm)	EMP-4266- ■■	2449.19	2637.33	2844.53	3293.81	3595.03	3782.71
	48"(1219mm)	EMP-466- ■■	2557.67	2762.13	2987.57	3476.09	3803.71	4008.07
	54"(1372mm)	EMP-5466- ■■	2666.15	2886.93	3130.61	3658.37	4012.39	4233.43
60"(1524mm)	EMP-566- ■■	2774.63	3011.73	3273.65	3840.65	4221.07	4458.79	
82"(2083mm)	12"(305mm)	EMP-180- ■■	\$2002.38	\$ 2130.20	\$ 2269.16	\$ 2572.36	\$ 2775.18	\$ 2899.90
	18"(457mm)	EMP-1880- ■■	2207.97	2352.11	2509.31	2851.75	3080.97	3222.37
	24"(610mm)	EMP-280- ■■	2398.17	2558.63	2734.07	3115.75	3371.37	3529.45
	30"(762mm)	EMP-3080- ■■	2588.37	2765.15	2958.83	3379.75	3661.77	3836.53
	36"(914mm)	EMP-380- ■■	2828.57	3021.67	3233.59	3693.75	4002.17	4193.61
	42"(1067mm)	EMP-4280- ■■	3018.77	3228.19	3458.35	3957.75	4292.57	4500.69
	48"(1219mm)	EMP-480- ■■	3208.97	3434.71	3683.11	4221.75	4582.97	4807.77
	54"(1372mm)	EMP-5480- ■■	3399.17	3641.23	3907.87	4485.75	4873.37	5114.85
60"(1524mm)	EMP-580- ■■	3589.37	3847.75	4132.63	4749.75	5163.77	5421.93	

Open Frame Panel with Steel Top Cap — No Power

UniGroup

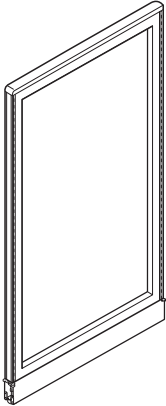

EON-B (Non-Powered)
Class AA

Features

- Includes non-powered panel assembly, radius steel top cap, with or without one-piece base raceway cover, 1.6 hinge kits, side trim rails, leveling glides and carpet gripper. **.6** base raceway end caps are shipped with each panel. Order additional as necessary.
- Panel thickness is 2"(51mm).
- Base raceway is 4"(102mm)H.
- Does not accept top feed modules.
- Shipped with unassembled top cap, base raceway cover and side trim rails.

Specification Tips

- Panels will accept glazed add-on panels up to a combined height of 82"(2083mm). For aesthetic consistency, specify UniGroup add-on panels.
- Raceway cover must be separately specified for option -BE (no raceway cover).
- Additional base raceway cover end caps will need to be specified if finish posts are not ordered.

To Order, Specify:

- 1) Product number, including:

① Options:

B With Raceway Cover

BE Without Raceway Cover
(deduct **\$175.36** list)

- 2) Trim color for raceway cover, glide housings and end caps. Not available in metallic trim colors.
- 3) Trim color for frame, top cap and side trim rails.

Note: Upcharge for mixed surface grades, refer to the electronic design and specification tools for pricing.

Notes:

- Non-powered panels ship without receptacle ports in the base raceway cover.
- Some building codes may restrict the use of panel heights greater than 69"(1753mm). Consult your local code authority to assure that the furniture layout is compliant.
- For International Power, specify non-powered panels and use Power Logic components. See Specification Guide for more information on Power Logic.
- For Chicago power, specify non-powered panels without a base raceway cover and separately specify Chicago power retrofit kit.

Open Frame Panel with Steel Top Cap — No Power

UniGroup

Actual Height	Width	Number ^①	Price
37"(940mm)	12"(305mm)	EON-135-■■■	\$ 1731.90
	18"(457mm)	EON-1835-■■■	1805.06
	24"(610mm)	EON-235-■■■	1878.22
	30"(762mm)	EON-3035-■■■	1951.38
	36"(914mm)	EON-335-■■■	2024.54
	42"(1067mm)	EON-4235-■■■	2097.70
	48"(1219mm)	EON-435-■■■	2170.86
	60"(1524mm)	EON-535-■■■	2317.18
44"(1118mm)	12"(305mm)	EON-142-■■■	\$ 1807.69
	18"(457mm)	EON-1842-■■■	1901.79
	24"(610mm)	EON-242-■■■	1995.89
	30"(762mm)	EON-3042-■■■	2089.99
	36"(914mm)	EON-342-■■■	2184.09
	42"(1067mm)	EON-4242-■■■	2278.19
	48"(1219mm)	EON-442-■■■	2372.29
	60"(1524mm)	EON-542-■■■	2560.49
64"(1626mm)	12"(305mm)	EON-162-■■■	\$ 2117.09
	18"(457mm)	EON-1862-■■■	2278.07
	24"(610mm)	EON-262-■■■	2439.05
	30"(762mm)	EON-3062-■■■	2600.03
	36"(914mm)	EON-362-■■■	2761.01
	42"(1067mm)	EON-4262-■■■	2921.99
	48"(1219mm)	EON-462-■■■	3082.97
	60"(1524mm)	EON-562-■■■	3404.93
68"(1727mm)	12"(305mm)	EON-166-■■■	\$ 2256.09
	18"(457mm)	EON-1866-■■■	2437.97
	24"(610mm)	EON-266-■■■	2619.85
	30"(762mm)	EON-3066-■■■	2801.73
	36"(914mm)	EON-366-■■■	2983.61
	42"(1067mm)	EON-4266-■■■	3165.49
	48"(1219mm)	EON-466-■■■	3347.37
	60"(1524mm)	EON-566-■■■	3711.13
82"(2083mm)	12"(305mm)	EON-180-■■■	\$ 2360.11
	18"(457mm)	EON-1880-■■■	2562.91
	24"(610mm)	EON-280-■■■	2765.71
	30"(762mm)	EON-3080-■■■	2968.51
	36"(914mm)	EON-380-■■■	3171.31
	42"(1067mm)	EON-4280-■■■	3374.11
	48"(1219mm)	EON-480-■■■	3576.91
	60"(1524mm)	EON-580-■■■	3982.51

Open Frame Panel with Steel Top Cap — Powered

UniGroup

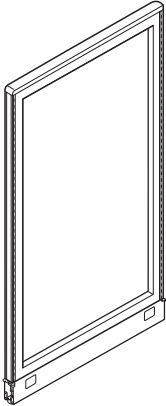

EOP-B (3-circuit)
Class AA



Features

- Includes powered panel assembly, radius steel top cap, with or without one-piece base raceway cover, 1.6 hinge kits, side trim rails, leveling glides and carpet gripper; power distribution assembly/flex connector(s). .6 base raceway end caps are shipped with each panel. Order additional as necessary.
- Panel thickness is 2" (51mm).
- Base raceway is 4" (102mm)H.
- Powered raceway with or without raceway cover requires modified catalog number and list price.
- Powered panels are available for countries that utilize 120 volt 60 hertz electrical systems and U.S. configured plugs and outlets.
- Does not accept top feed modules.
- Shipped with unassembled top cap, base raceway cover and side trim rails.

Specification Tips

- Panels will accept glazed add-on panels up to a combined height of 82" (2083mm). For aesthetic consistency, specify UniGroup add-on panels.
- Flex connectors provided for powered monolithic panels accommodate straight in-line, inside 90°, and inside 120° conditions (if applicable).
- Receptacles for powered panels must be specified separately.
- Raceway cover must be separately specified for option -BE or BYE (no raceway cover).
- Additional base raceway cover end caps will need to be specified if finish posts are not ordered.

To Order, Specify:

1) Product number, including:

1 3-Circuit

B With Raceway Cover

BE Without Raceway Cover
(deduct **\$193.09** list)

BY NYC with Raceway Cover

BYE NYC without Raceway Cover
(deduct **\$193.09** list)

2) Trim color for raceway cover, glide housings and end caps. Not available in metallic trim colors.









































3) Trim color for frame, top cap and side trim rails.

Note: Upcharge for mixed surface grades, refer to the electronic design and specification tools for pricing.

Notes:

- Powered panels with raceway covers ship with receptacle ports in the base raceway cover. Receptacle ports on the raceway cover measure 2.35" (60mm) top-to-bottom and 2.88" (73mm) side-to-side.
- Powered panels with Power Distribution Assemblies (PDA) but without raceway covers require separately specified base raceway covers for power and communication port locations other than the standard powered base raceway cover.
- New York City (NYC) electrical applications require field installation of PDA.
- New York Port Authority (NYPA) electrical applications require metal raceway covers. To order, specify NYC powered panels without raceway cover and separately specify metal covers through Haworth eParts.
- Some building codes may restrict the use of panel heights greater than 69" (1753mm). Consult your local code authority to assure that the furniture layout is compliant.
- For International Power, specify non-powered panels and use Power Logic components. See Specification Guide for more information on Power Logic.
- For Chicago power, specify non-powered panels without a base raceway cover and separately specify Chicago power retrofit kit.

Open Frame Panel with Steel Top Cap — Powered UniGroup

Actual Height	Width	Number 	Price
37"(940mm)	12"(305mm)	EOP-135- 	\$ 2212.53
	18"(457mm)	EOP-1835- 	2303.42
	24"(610mm)	EOP-235- 	2376.58
	30"(762mm)	EOP-3035- 	2449.74
	36"(914mm)	EOP-335- 	2522.90
	42"(1067mm)	EOP-4235- 	2596.06
	48"(1219mm)	EOP-435- 	2669.22
	60"(1524mm)	EOP-535- 	2815.54
44"(1118mm)	12"(305mm)	EOP-142- 	\$ 2288.32
	18"(457mm)	EOP-1842- 	2400.15
	24"(610mm)	EOP-242- 	2494.25
	30"(762mm)	EOP-3042- 	2588.35
	36"(914mm)	EOP-342- 	2682.45
	42"(1067mm)	EOP-4242- 	2776.55
	48"(1219mm)	EOP-442- 	2870.65
	60"(1524mm)	EOP-542- 	3058.85
64"(1626mm)	12"(305mm)	EOP-162- 	\$ 2597.72
	18"(457mm)	EOP-1862- 	2776.43
	24"(610mm)	EOP-262- 	2937.41
	30"(762mm)	EOP-3062- 	3098.39
	36"(914mm)	EOP-362- 	3259.37
	42"(1067mm)	EOP-4262- 	3420.35
	48"(1219mm)	EOP-462- 	3581.33
	60"(1524mm)	EOP-562- 	3903.29
68"(1727mm)	12"(305mm)	EOP-166- 	\$ 2736.72
	18"(457mm)	EOP-1866- 	2936.33
	24"(610mm)	EOP-266- 	3118.21
	30"(762mm)	EOP-3066- 	3300.09
	36"(914mm)	EOP-366- 	3481.97
	42"(1067mm)	EOP-4266- 	3663.85
	48"(1219mm)	EOP-466- 	3845.73
	60"(1524mm)	EOP-566- 	4209.49
82"(2083mm)	12"(305mm)	EOP-180- 	\$ 2840.74
	18"(457mm)	EOP-1880- 	3061.27
	24"(610mm)	EOP-280- 	3264.07
	30"(762mm)	EOP-3080- 	3466.87
	36"(914mm)	EOP-380- 	3669.67
	42"(1067mm)	EOP-4280- 	3872.47
	48"(1219mm)	EOP-480- 	4075.27
	60"(1524mm)	EOP-580- 	4480.87

Glazed Monolithic Panel with Steel Top Cap — No Power

UniGroup

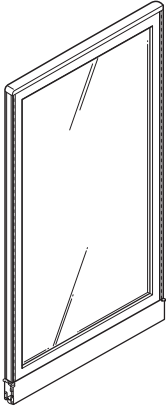

EGN-B (Non-Powered)
Class AA

Features

- Includes non-powered panel assembly, radius steel top cap, with or without one-piece base raceway cover, 1.6 hinge kits, side trim rails, leveling glides and carpet gripper. **.6** base raceway end caps are shipped with each panel. Order additional as necessary.
- Panel thickness is 2"(51mm).
- Base raceway is 4"(102mm)H.
- Does not accept top feed modules.
- Shipped with unassembled top cap, base raceway cover and side trim rails.

Specification Tips

- Panels will accept glazed add-on panels up to a combined height of 82"(2083mm). For aesthetic consistency, specify UniGroup add-on panels.
- Raceway cover must be separately specified for option -BE (no raceway cover).
- Additional base raceway cover end caps will need to be specified if finish post are not ordered.

To Order, Specify:

- 1) Product number, including:

① Options:

- B** With Raceway Cover
- BE** Without Raceway Cover (deduct **\$175.36** list)

- 2) Glazing finish color.
- 3) Trim color for raceway cover, glide housings and end caps. Not available in metallic trim colors.
- 4) Trim color for frame, top cap and side trim rails.

Note: Upcharge for mixed surface grades, refer to the electronic design and specification tools for pricing.

Notes:

- Non-powered panels ship without receptacle ports in the base raceway cover.
- Some building codes may restrict the use of panel heights greater than 69"(1753mm). Consult your local code authority to assure that the furniture layout is compliant.
- For International Power, specify non-powered panels and use Power Logic components. See Specification Guide for more information on Power Logic.
- For Chicago power, specify non-powered panels without a base raceway cover and separately specify Chicago power retrofit kit.

Glazed Monolithic Panel with Steel Top Cap — No Power

UniGroup

Actual Height	Width	Number ^①	Clear	Frosted
44"(1118mm)	12"(305mm)	EGN-142-■ ■	\$ 2887.06	\$ 3870.37
	18"(457mm)	EGN-1842-■ ■	3170.54	4347.23
	24"(610mm)	EGN-242-■ ■	3454.02	4824.09
	30"(762mm)	EGN-3042-■ ■	3737.50	5300.95
	36"(914mm)	EGN-342-■ ■	4020.98	5777.81
	42"(1067mm)	EGN-4242-■ ■	4304.46	6254.67
	48"(1219mm)	EGN-442-■ ■	4587.94	6731.53
	60"(1524mm)	EGN-542-■ ■	5154.90	7685.25
56"(1422mm)	12"(305mm)	EGN-154-■ ■	\$ 2914.25	\$ 3871.28
	18"(457mm)	EGN-1854-■ ■	3244.98	4411.68
	24"(610mm)	EGN-254-■ ■	3575.71	4952.08
	30"(762mm)	EGN-3054-■ ■	3906.44	5492.48
	36"(914mm)	EGN-354-■ ■	4237.17	6032.88
	42"(1067mm)	EGN-4254-■ ■	4567.90	6573.28
	48"(1219mm)	EGN-454-■ ■	4898.63	7113.68
	60"(1524mm)	EGN-554-■ ■	5560.09	8194.48
64"(1626mm)	12"(305mm)	EGN-162-■ ■	\$ 3171.40	\$ 4316.53
	18"(457mm)	EGN-1862-■ ■	3502.13	4856.93
	24"(610mm)	EGN-262-■ ■	3832.86	5397.33
	30"(762mm)	EGN-3062-■ ■	4163.59	5937.73
	36"(914mm)	EGN-362-■ ■	4494.32	6478.13
	42"(1067mm)	EGN-4262-■ ■	4825.05	7018.53
	48"(1219mm)	EGN-462-■ ■	5155.78	7558.93
	60"(1524mm)	EGN-562-■ ■	5817.24	8639.73
68"(1727mm)	12"(305mm)	EGN-166-■ ■	\$ 3313.14	\$ 4507.29
	18"(457mm)	EGN-1866-■ ■	3643.87	5047.69
	24"(610mm)	EGN-266-■ ■	3974.60	5588.09
	30"(762mm)	EGN-3066-■ ■	4305.33	6128.49
	36"(914mm)	EGN-366-■ ■	4636.06	6668.89
	42"(1067mm)	EGN-4266-■ ■	4966.79	7209.29
	48"(1219mm)	EGN-466-■ ■	5297.52	7749.69
	60"(1524mm)	EGN-566-■ ■	5958.98	8830.49
82"(2083mm)	12"(305mm)	EGN-180-■ ■	\$3442.24	\$4760.46
	18"(457mm)	EGN-1880-■ ■	3910.00	5389.84
	24"(610mm)	EGN-280-■ ■	4377.76	6019.22
	30"(762mm)	EGN-3080-■ ■	4845.52	6648.60
	36"(914mm)	EGN-380-■ ■	5313.28	7277.98
	42"(1067mm)	EGN-4280-■ ■	5781.04	7907.36
	48"(1219mm)	EGN-480-■ ■	6248.80	8536.74
	60"(1524mm)	EGN-580-■ ■	7184.32	9795.50

Glazed Monolithic Panel with Steel Top Cap — Powered UniGroup

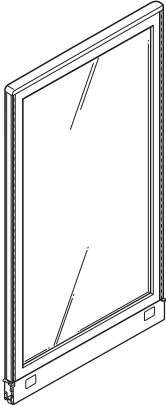

EGP-B (3-circuit)
Class AA



Features

- Includes powered panel assembly, radius steel top cap, with or without one-piece base raceway cover, 1.6 hinge kits, side trim rails, leveling glides and carpet gripper; power distribution assembly/flex connector(s). .6 base raceway end caps are shipped with each panel. Order additional as necessary.
- Panel thickness is 2"(51mm).
- Base raceway is 4"(102mm)H.
- Powered raceway with or without raceway cover requires modified catalog number and list price.
- Powered panels are available for countries that utilize 120 volt 60 hertz electrical systems and U.S. configured plugs and outlets.
- Does not accept top feed modules.
- Shipped with unassembled top cap, base raceway cover and side trim rails.

Specification Tips

- Panels will accept glazed add-on panels up to a combined height of 82"(2083mm). For aesthetic consistency, specify UniGroup add-on panels.
- Flex connectors provided for powered monolithic panels accommodate straight in-line, inside 90°, and inside 120° conditions (if applicable).
- Receptacles for powered panels must be specified separately.
- Raceway cover must be separately specified for option -BE or BYE (no raceway cover).
- Additional base raceway cover end caps will need to be specified if finish post are not ordered.

To Order, Specify:

1) Product number, including:

1 3-Circuit

B With Raceway Cover

BE Without Raceway Cover
(deduct **\$175.36** list)

BY NYC with Raceway Cover

BYE NYC without Raceway Cover
(deduct **\$175.36** list)

2) Glazing finish color.

3) Trim color for raceway cover, glide housings and end caps. Not available in metallic trim colors.

4) Trim color for frame, top cap and side trim rails.

Note: Upcharge for mixed surface grades, refer to the electronic design and specification tools for pricing.

Notes:

- Powered panels with raceway covers ship with receptacle ports in the base raceway cover. Receptacle ports on the raceway cover measure 2.35"(60mm) top-to-bottom and 2.88"(73mm) side-to-side.
- Powered panels with Power Distribution Assemblies (PDA) but without raceway covers require separately specified base raceway covers for power and communication port locations other than the standard powered base raceway cover.
- New York City (NYC) electrical applications require field installation of PDA.
- New York Port Authority (NYPA) electrical applications require metal raceway covers. To order, specify NYC powered panels without raceway cover and separately specify metal covers through Haworth eParts.
- Some building codes may restrict the use of panel heights greater than 69"(1753mm). Consult your local code authority to assure that the furniture layout is compliant.
- For International Power, specify non-powered panels and use Power Logic components. See Specification Guide for more information on Power Logic.
- For Chicago power, specify non-powered panels without a base raceway cover and separately specify Chicago power retrofit kit.

Glazed Monolithic Panel with Steel Top Cap — Powered UniGroup

Actual Height	Width	Number ^①	Clear	Frosted
44"(1118mm)	12"(305mm)	EGP-142-■■■	\$ 3367.69	\$ 4351.00
	18"(457mm)	EGP-1842-■■■	3668.90	4845.59
	24"(610mm)	EGP-242-■■■	3952.38	5322.45
	30"(762mm)	EGP-3042-■■■	4235.86	5799.31
	36"(914mm)	EGP-342-■■■	4519.34	6276.17
	42"(1067mm)	EGP-4242-■■■	4802.82	6753.03
	48"(1219mm)	EGP-442-■■■	5086.30	7229.89
	60"(1524mm)	EGP-542-■■■	5653.26	8183.61
56"(1422mm)	12"(305mm)	EGP-154-■■■	\$ 3394.88	\$ 4351.91
	18"(457mm)	EGP-1854-■■■	3743.34	4910.04
	24"(610mm)	EGP-254-■■■	4074.07	5450.44
	30"(762mm)	EGP-3054-■■■	4404.80	5990.84
	36"(914mm)	EGP-354-■■■	4735.53	6531.24
	42"(1067mm)	EGP-4254-■■■	5066.26	7071.64
	48"(1219mm)	EGP-454-■■■	5396.99	7612.04
	60"(1524mm)	EGP-554-■■■	6058.45	8692.84
64"(1626mm)	12"(305mm)	EGP-162-■■■	\$ 3652.03	\$ 4797.16
	18"(457mm)	EGP-1862-■■■	4000.49	5355.29
	24"(610mm)	EGP-262-■■■	4331.22	5895.69
	30"(762mm)	EGP-3062-■■■	4661.95	6436.09
	36"(914mm)	EGP-362-■■■	4992.68	6976.49
	42"(1067mm)	EGP-4262-■■■	5323.41	7516.89
	48"(1219mm)	EGP-462-■■■	5654.14	8057.29
	60"(1524mm)	EGP-562-■■■	6315.60	9138.09
68"(1727mm)	12"(305mm)	EGP-166-■■■	\$ 3793.77	\$ 4987.92
	18"(457mm)	EGP-1866-■■■	4142.23	5546.05
	24"(610mm)	EGP-266-■■■	4472.96	6086.45
	30"(762mm)	EGP-3066-■■■	4803.69	6626.85
	36"(914mm)	EGP-366-■■■	5134.42	7167.25
	42"(1067mm)	EGP-4266-■■■	5465.15	7707.65
	48"(1219mm)	EGP-466-■■■	5795.88	8248.05
	60"(1524mm)	EGP-566-■■■	6457.34	9328.85
82"(2083mm)	12"(305mm)	EGP-180-■■■	\$ 3922.87	\$ 5241.09
	18"(457mm)	EGP-1880-■■■	4408.36	5888.20
	24"(610mm)	EGP-280-■■■	4876.12	6517.58
	30"(762mm)	EGP-3080-■■■	5343.88	7146.96
	36"(914mm)	EGP-380-■■■	5811.64	7776.34
	42"(1067mm)	EGP-4280-■■■	6279.40	8405.72
	48"(1219mm)	EGP-480-■■■	6747.16	9035.10
	60"(1524mm)	EGP-580-■■■	7682.68	10293.86

Fabric Add-On Panel

UniGroup

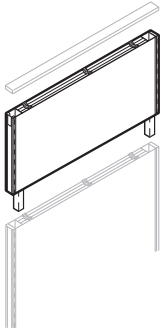

EAF
Class AA

Note: This panel has fabric/colorway restrictions, see Fabrics/Color Legend.

Features

- Includes panel, vertical connector (bayonet), light block, side trim rails, two full hinge sets, one side trim rail cover and top cap clips.
- Fabric add-on panels may be installed above any straight fabric and laminate base or fabric add-on panels.
- Both sides in same fabric; one color or different color each side.
- Each base panel will accept two add-on panels.
- Lower Level add-on panel will accept overhead components (load bearing). Second add-on panel (top) is non-load bearing.
- Utilizes top cap from base panel.
- Standard finish posts can be used.
- Same construction as UniGroup Monolithic fabric panel.

Specification Tips

- For mixed fabric surfaces, specify fabric/color for each fabric surface and price at higher grade.
- Add-on panels may be stacked a maximum of two high in any order of height above a base panel.
- Add-on panel must match panel width.
- Combination of panel and add-on panel cannot exceed 82"(2083mm) in height.
- Cannot be used above any door, glazed, legacy videne, open-frame or glazed add-on panels.
- Base and add-on panel combinations should match existing base panel heights so that end-of-runs and finish posts can be used without field modification.
- Full-height side trim rails required for end-of-run conditions with a base panel and one add-on panel, separately specified.
- For two high add-on panel applications specify separately full-height side trim rail for base panel and one high add on, for two high panel add on location use side trim rail that ships with add-on panel.
- Clerestory can be added above fabric add-on panels. See Specification Guide for application guidelines.

To Order, Specify:

- 1) Product number.
- 2) Fabric/colorway for add-on panel side one.
- 3) Fabric/colorway for add-on panel side two.
- 4) Trim color for side trim rails, and trim strip.

Fabric Add-On Panel

UniGroup

Actual Height	Width	Number	Fabric					
			A	B	C	E	F	G
12"(305mm)	12"(305mm)	EAJ-112	\$ 1179.98	\$ 1227.00	\$ 1235.46	\$ 1252.56	\$ 1261.10	\$ 1269.64
	18"(457mm)	EAJ-1812	1239.76	1295.82	1314.26	1353.18	1376.26	1393.90
	24"(610mm)	EAJ-212	1299.54	1364.64	1393.06	1453.80	1491.42	1518.16
	30"(762mm)	EAJ-3012	1359.32	1433.46	1471.86	1554.42	1606.58	1642.42
	36"(914mm)	EAJ-312	1419.10	1502.28	1550.66	1655.04	1721.74	1766.68
	42"(1067mm)	EAJ-4212	1478.88	1571.10	1629.46	1755.66	1836.90	1890.94
	48"(1219mm)	EAJ-412	1538.66	1639.92	1708.26	1856.28	1952.06	2015.20
	54"(1372mm)	EAJ-5412	1598.44	1708.74	1787.06	1956.90	2067.22	2139.46
60"(1524mm)	EAJ-512	1658.22	1777.56	1865.86	2057.52	2182.38	2263.72	
14"(356mm)	12"(305mm)	EAJ-114	\$ 1237.64	\$ 1293.40	\$ 1311.48	\$ 1349.66	\$ 1372.20	\$ 1389.52
	18"(457mm)	EAJ-1814	1297.42	1362.22	1390.28	1450.28	1487.36	1513.78
	24"(610mm)	EAJ-214	1357.20	1431.04	1469.08	1550.90	1602.52	1638.04
	30"(762mm)	EAJ-3014	1416.98	1499.86	1547.88	1651.52	1717.68	1762.30
	36"(914mm)	EAJ-314	1476.76	1568.68	1626.68	1752.14	1832.84	1886.56
	42"(1067mm)	EAJ-4214	1536.54	1637.50	1705.48	1852.76	1948.00	2010.82
	48"(1219mm)	EAJ-414	1596.32	1706.32	1784.28	1953.38	2063.16	2135.08
	54"(1372mm)	EAJ-5414	1656.10	1775.14	1863.08	2054.00	2178.32	2259.34
60"(1524mm)	EAJ-514	1715.88	1843.96	1941.88	2154.62	2293.48	2383.60	
18"(457mm)	12"(305mm)	EAJ-118	\$ 1352.96	\$ 1426.20	\$ 1463.52	\$ 1543.86	\$ 1594.40	\$ 1629.28
	18"(457mm)	EAJ-1818	1412.74	1495.02	1542.32	1644.48	1709.56	1753.54
	24"(610mm)	EAJ-218	1472.52	1563.84	1621.12	1745.10	1824.72	1877.80
	30"(762mm)	EAJ-3018	1532.30	1632.66	1699.92	1845.72	1939.88	2002.06
	36"(914mm)	EAJ-318	1592.08	1701.48	1778.72	1946.34	2055.04	2126.32
	42"(1067mm)	EAJ-4218	1651.86	1770.30	1857.52	2046.96	2170.20	2250.58
	48"(1219mm)	EAJ-418	1711.64	1839.12	1936.32	2147.58	2285.36	2374.84
	54"(1372mm)	EAJ-5418	1771.42	1907.94	2015.12	2248.20	2400.52	2499.10
60"(1524mm)	EAJ-518	1831.20	1976.76	2093.92	2348.82	2515.68	2623.36	
20"(508mm)	12"(305mm)	EAJ-120	\$ 1410.62	\$ 1492.60	\$ 1539.54	\$ 1640.96	\$ 1705.50	\$ 1749.16
	18"(457mm)	EAJ-1820	1470.40	1561.42	1618.34	1741.58	1820.66	1873.42
	24"(610mm)	EAJ-220	1530.18	1630.24	1697.14	1842.20	1935.82	1997.68
	30"(762mm)	EAJ-3020	1589.96	1699.06	1775.94	1942.82	2050.98	2121.94
	36"(914mm)	EAJ-320	1649.74	1767.88	1854.74	2043.44	2166.14	2246.20
	42"(1067mm)	EAJ-4220	1709.52	1836.70	1933.54	2144.06	2281.30	2370.46
	48"(1219mm)	EAJ-420	1769.30	1905.52	2012.34	2244.68	2396.46	2494.72
	54"(1372mm)	EAJ-5420	1829.08	1974.34	2091.14	2345.30	2511.62	2618.98
60"(1524mm)	EAJ-520	1888.86	2043.16	2169.94	2445.92	2626.78	2743.24	
24"(610mm)	12"(305mm)	EAJ-124	\$ 1525.94	\$ 1625.40	\$ 1691.58	\$ 1835.16	\$ 1927.70	\$ 1988.92
	18"(457mm)	EAJ-1824	1585.72	1694.22	1770.38	1935.78	2042.86	2113.18
	24"(610mm)	EAJ-224	1645.50	1763.04	1849.18	2036.40	2158.02	2237.44
	30"(762mm)	EAJ-3024	1705.28	1831.86	1927.98	2137.02	2273.18	2361.70
	36"(914mm)	EAJ-324	1765.06	1900.68	2006.78	2237.64	2388.34	2485.96
	42"(1067mm)	EAJ-4224	1824.84	1969.50	2085.58	2338.26	2503.50	2610.22
	48"(1219mm)	EAJ-424	1884.62	2038.32	2164.38	2438.88	2618.66	2734.48
	54"(1372mm)	EAJ-5424	1944.40	2107.14	2243.18	2539.50	2733.82	2858.74
60"(1524mm)	EAJ-524	2004.18	2175.96	2321.98	2640.12	2848.98	2983.00	

Glazed Add-On Panel

UniGroup

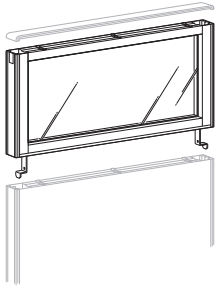

EAG
Class AA

Note: *Add-on panel cannot be used with add-on panels ordered with the SP** prefix.

Features

- Includes panel, vertical connector (bayonet), light block, side trim rails, two full hinge sets, one side trim rail cover, and top cap clips.
- Utilizes top cap from base panel.
- Glazed add-on panels may be installed above any straight fabric, glazed, laminate, or open-frame base or add-on panels.*
- Each base panel will accept two add-on panels.
- Glazed add-on panels will not accept any load bearing components.
- Top rail of add-on panel will provide top wire management.
- Textured glazing material is textured on one side only. Recommend installing the textured side to face the interior of the workstation.
- Standard finish post and end-of-run posts can be used.

Specification Tips

- Specify glazed add-on panel based upon the type of panel, fabric (F)/laminate (L) or glazed/open-frame (G), that will be directly below the add-on panel.
- Add-on panels may be stacked a maximum of two high in any order of height above a base panel.
- Add-on panel must match base panel width.
- Combination of base panel and add-on panel cannot exceed 82”(2083mm) in height.
- Base and add-on panel combinations should match existing base panel heights so that end-of-runs and finish posts can be used without field modification.
- Cannot be used above doors, or legacy videne panels.
- Does not accept top feed modules.
- To convert a glazed add-on above a fabric/laminate monolithic base panel to a glazed add-on above a glazed base panel or (vice versa), a vertical connector (bayonet) retrofit kit is available. Order separately through Haworth eParts.
- Full-height side trim rails required for end-of-run conditions with a base panel and one add-on panel, separately specified.
- For two high add-on panel applications specify separately full-height side trim rail for base panel and one high add on, for two high panel add on location use side trim rail that ships with add-on panel.
- Clerestory can be added above glazed add-on panels. See Specification Guide for application guidelines.
- **Patterned Glass (SQ-CM Checks Mix, SQ-ER English Reeded and SQ-VM Vertical Moire) available on 12”(305mm) and 18”(457mm) high add-on panels only.**

To Order, Specify:

1) Product number, including:

1 Application Designation













































- F** Glazed add-on panel directly above fabric/laminate base panel or fabric add-on panel.
- G** Glazed add-on panel directly above glazed and open frame base panel or glazed add-on panel (add **\$64.79** list).

2) Glazing color or glass pattern.

3) Trim color for frame, side trim rails and trim strip.

Glazed Add-On Panel

UniGroup

Actual Height	Width	Number ①	Glass		
			A	C	D
12"(305mm)	12"(305mm)	EAG-112- 	\$ 1224.05	\$ 1490.76	\$ 1560.49
	18"(457mm)	EAG-1812- 	1322.69	1626.80	1696.53
	24"(610mm)	EAG-212- 	1421.33	1762.84	1832.57
	30"(762mm)	EAG-3012- 	1519.97	1898.88	1968.61
	36"(914mm)	EAG-312- 	1618.61	2034.92	2104.65
	42"(1067mm)	EAG-4212- 	1717.25	2170.96	2240.69
	48"(1219mm)	EAG-412- 	1815.89	2307.00	2376.73
	54"(1372mm)	EAG-5412- 	1914.53	2443.04	2512.77
14"(356mm)	60"(1524mm)	EAG-512- 	2013.17	2579.08	2648.81
	12"(305mm)	EAG-114- 	\$ 1283.62	N/A	\$ 1705.61
	18"(457mm)	EAG-1814- 	1382.26	N/A	1841.65
	24"(610mm)	EAG-214- 	1480.90	N/A	1977.69
	30"(762mm)	EAG-3014- 	1579.54	N/A	2113.73
	36"(914mm)	EAG-314- 	1678.18	N/A	2249.77
	42"(1067mm)	EAG-4214- 	1776.82	N/A	2385.81
	48"(1219mm)	EAG-414- 	1875.46	N/A	2521.85
18"(457mm)	54"(1372mm)	EAG-5414- 	1974.10	N/A	2657.89
	60"(1524mm)	EAG-514- 	2072.74	N/A	2793.93
	12"(305mm)	EAG-118- 	\$ 1402.76	\$ 1721.88	\$ 1995.85
	18"(457mm)	EAG-1818- 	1501.40	1857.92	2131.89
	24"(610mm)	EAG-218- 	1600.04	1993.96	2267.93
	30"(762mm)	EAG-3018- 	1698.68	2130.00	2403.97
	36"(914mm)	EAG-318- 	1797.32	2266.04	2540.01
	42"(1067mm)	EAG-4218- 	1895.96	2402.08	2676.05
18"(457mm)	48"(1219mm)	EAG-418- 	1994.60	2538.12	2812.09
	54"(1372mm)	EAG-5418- 	2093.24	2674.16	2948.13
	60"(1524mm)	EAG-518- 	2191.88	2810.20	3084.17
	12"(305mm)	EAG-120- 	\$ 1462.33	N/A	\$ 2140.97
	18"(457mm)	EAG-1820- 	1560.97	N/A	2277.01
	24"(610mm)	EAG-220- 	1659.61	N/A	2413.05
	30"(762mm)	EAG-3020- 	1758.25	N/A	2549.09
	36"(914mm)	EAG-320- 	1856.89	N/A	2685.13
20"(508mm)	42"(1067mm)	EAG-4220- 	1955.53	N/A	2821.17
	48"(1219mm)	EAG-420- 	2054.17	N/A	2957.21
	54"(1372mm)	EAG-5420- 	2152.81	N/A	3093.25
	60"(1524mm)	EAG-520- 	2251.45	N/A	3229.29
	12"(305mm)	EAG-124- 	\$ 1581.47	N/A	\$ 2431.21
	18"(457mm)	EAG-1824- 	1680.11	N/A	2567.25
	24"(610mm)	EAG-224- 	1778.75	N/A	2703.29
	30"(762mm)	EAG-3024- 	1877.39	N/A	2839.33
24"(610mm)	36"(914mm)	EAG-324- 	1976.03	N/A	2975.37
	42"(1067mm)	EAG-4224- 	2074.67	N/A	3111.41
	48"(1219mm)	EAG-424- 	2173.31	N/A	3247.45
	54"(1372mm)	EAG-5424- 	2271.95	N/A	3383.49
	60"(1524mm)	EAG-524- 	2370.59	N/A	3519.53

*Patterned Glass (SQ-CM Checks Mix, SQ-ER English Reeded and SQ-VM Vertical Moire) available on 12"(305mm) and 18"(457mm) high add-on panels only.

Swing Door with Steel Top Cap

UniGroup

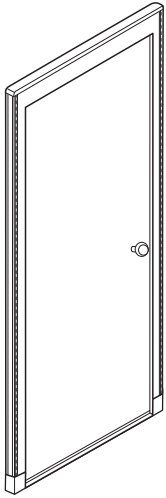

EDS-BHL

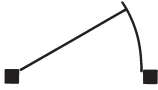

(Left-hand swing)
Class AA

Features

- Includes complete panel assembly [hinge sets, carpet gripper, door jamb, side trim rails, leveling glides and trim, hollow core door (1.625"(41mm) thick), door hinges, hardware, ADA lever with lockset and keys, and threshold].
- Both sides of door covered in same high-pressure laminate (HPL) surface color.
- Doors are shipped left-hand swing. Field-adjustable for right-hand swing.
- No power or communications in base raceway.

Specification Tips

- Door may be placed a maximum of 24"(610mm) from supporting panels at 90°.
- Will not accept add-on panel.

Door Opening Clearance

Door Size	Height	Width
380	78"(1981mm)	28.75"(730mm)
4280	78"(1981mm)	34.75"(883mm)

To Order, Specify:

- 1) Product number, including:
- 2) Laminate surface color.
- 3) Trim color for raceway covers and glide housings. Not available in metallic trim colors.
- 4) Trim color for door jamb, top cap and side trim rails.

Notes: Some building codes may restrict the use of panel heights greater than 69"(1753mm). Consult your local code authority to assure that the furniture layout is compliant prior to installation.

Most building codes for new buildings require a minimum clear door width of 32"(813mm). To meet this requirement, the 42"(1067mm) door must be ordered.

Actual Height	Width	Door Swing	Number	HPL	
				A	B
82"(2083mm)	36"(914mm)	Left	EDS-380-BHL	\$5640.66	\$5959.62
	42"(1067mm)	Left	EDS-4280-BHL	5892.41	6231.52

Panel Accessories

UniGroup

90° Finish Post — for Steel Top Cap — Painted Surface

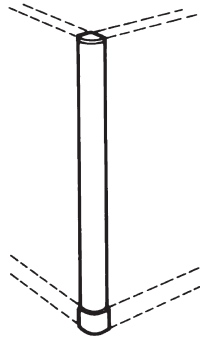

FPPC-B
Class AA

Features

- Includes 90° painted vertical cover, radius plastic top cap and base raceway cover.
- Required by UL for covering base raceway flexible and straight-span power connectors when power connector covers are not used.

To Order, Specify:

- 1) Product number.
- 2) Paint surface color.
- 3) Trim color for raceway cover.
- 4) Trim color for top cap.

Actual Height	Width	Number	Price
30"(762mm)	2"(51mm)	FPPC-28-B	\$ 180.63
37"(940mm)		FPPC-35-B	191.13
44"(1118mm)		FPPC-42-B	201.63
50"(1270mm)		FPPC-48-B	210.63
56"(1422mm)		FPPC-54-B	219.63
64"(1626mm)		FPPC-62-B	231.63
68"(1727mm)		FPPC-66-B	237.63
82"(2083mm)		FPPC-80-B	258.63

90° Power Connector Cover

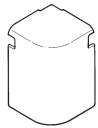

PCC-90-B
Class AA

Features

- Includes six power connector covers.
- Required by UL for covering flexible power connector in 90° panel configurations when a finish post is not used.

To Order, Specify:

- 1) Product number.
- 2) Trim color.

Specification Tip

- For use with UniGroup panels.

Actual Height	Number	Price
4"(102mm)	PCC-90-B	\$136.10

180° Power Connector Cover — Radius Profile

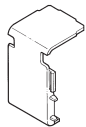

PCC-180-B
Class AA

Features

- Includes six power connector covers.
- Required by UL for covering straight-span or flexible power connectors in 180°, three-way panel configurations when a finish post is not used.

To Order, Specify:

- 1) Product number.
- 2) Trim color.

Specification Tip

- For use with UniGroup Too and UniGroup panels.

Actual Height	Number	Price
4"(102mm)	PCC-180-B	\$136.10

Panel Accessories

UniGroup

180° Finish Post — for Steel Top Cap — Painted Surface

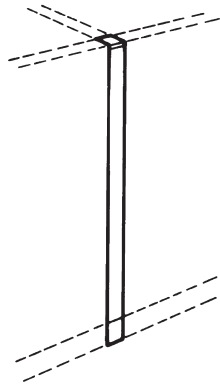

FPPS-B
Class AA

Features

- Includes 180° painted vertical cover, radius plastic top cap and base raceway cover.
- Required by UL for covering base raceway flexible and straight-span power connectors when power connector covers are not used.

To Order, Specify:

- 1) Product number.
- 2) Paint surface color.
- 3) Trim color for raceway cover.
- 4) Trim color for top cap.

Actual Height	Width	Number	Price
30"(762mm)	2"(51mm)	FPPS-28-B	\$ 154.47
37"(940mm)		FPPS-35-B	164.76
44"(1118mm)		FPPS-42-B	175.05
50"(1270mm)		FPPS-48-B	183.87
56"(1422mm)		FPPS-54-B	192.69
64"(1626mm)		FPPS-62-B	204.45
68"(1727mm)		FPPS-66-B	210.33
82"(2083mm)		FPPS-80-B	230.91

Steel Top Cap for 3-Way and 4-Way



FPC-2
Class AA

Features

- Includes one plastic top cap.
- Fills gap at intersection of four UniGroup radius steel top cap panels.

To Order, Specify:

- 1) Product number.
- 2) Trim color.

Height	Depth	Width	Number	Price
0.75"(19mm)	2"(51mm)	2"(51mm)	FPC-2	\$53.28

Panel Accessories

UniGroup

Full-Height Side Trim Rails — for use with Add-On Panels

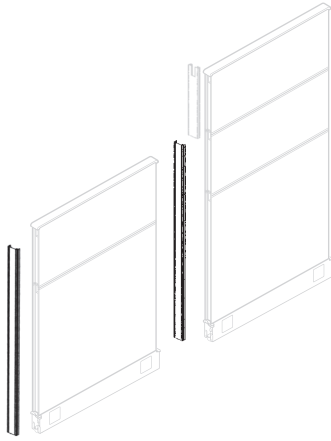

SREH
Class AA

Feature

- Includes one full height side trim rail.

Specification Tips

- For use with base panel and one add-on panel.
- For two high add-on panel applications specify separately full-height side trim rail for base panel and one high add-on, for two high panel location use side trim rail that ships with add-on panel. See Specification Guide for application guidelines.

To Order, Specify:

- 1) Product number.
- 2) Trim color.

Height	Base Panel Height/ Add-On Panel	Number	Trim	
			A	B
44"(1118mm)	30"(762mm)/14"(356mm)	SREH-2814	\$ 177.97	\$ 217.97
50"(1270mm)	30"(762mm)/20"(508mm)	SREH-2820	185.23	238.55
56"(1422mm)	44"(1118mm)/12"(305mm)	SREH-4212	192.49	259.13
64"(1626mm)	44"(1118mm)/20"(508mm)	SREH-4220	202.17	286.57
68"(1727mm)	44"(1118mm)/24"(610mm)	SREH-4224	207.01	300.29
64"(1626mm)	50"(1270mm)/14"(356mm)	SREH-4814	202.17	286.57
68"(1727mm)	50"(1270mm)/18"(457mm)	SREH-4818	207.01	300.29
68"(1727mm)	56"(1422mm)/12"(305mm)	SREH-5412	207.01	300.29
82"(2083mm)	64"(1626mm)/18"(457mm)	SREH-6218	223.95	348.31
82"(2083mm)	68"(1727mm)/14"(356mm)	SREH-6614	223.95	348.31

Side Trim Rail



SRE
Class AA

Features

- Includes one side trim rail.
- Specify two side trim rails for each condition.
- Two side trim rails are included with each panel.
- Order as replacement only.
- For UniGroup panels only.

To Order, Specify:

- 1) Product number.
- 2) Trim color.

Height	Number	Trim	
		A	B
30"(762mm)	SRE-28	\$134.48	\$ 143.40
37"(940mm)	SRE-35	142.95	167.41
44"(1118mm)	SRE-42	151.42	191.42
50"(1270mm)	SRE-48	158.68	212.00
56"(1422mm)	SRE-54	165.94	232.58
64"(1626mm)	SRE-62	175.62	260.02
68"(1727mm)	SRE-66	180.46	273.74
82"(2083mm)	SRE-80	197.40	321.76

Panel Accessories

UniGroup

Hinges



HE
Class AA

Features

- Includes one hinge set for one side of trim rail.
- For replacement only (hinges are included with panels).
- One hinge set connects every two panels for angular connections.
- Two hinges set are used for straight-line conditions.

To Order, Specify:

- 1) Product number.
- 2) Trim color.

Panel Height	Hinge Width	Number	Price
30"(762mm)	1.125"(29mm)	HE-28	\$23.58
37"(940mm)		HE-35	24.70
44"(1118mm)		HE-42	25.26
50"(1270mm)		HE-48	25.82
56"(1422mm)		HE-54	26.38
64"(1626mm)		HE-62	26.94
68"(1727mm)		HE-66	27.50
82"(2083mm)		HE-80	28.62

Wall Track

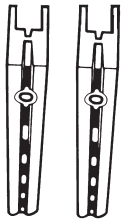

WT
Class AA

Features

- Includes two wall tracks and attachment screws (#10 2.5"(64mm) long).
- For attachment of components to structural walls.
- See installation instructions for proper mounting.

To Order, Specify:

- 1) Product number.
- 2) Trim color for track.

Specification Tips

- Not for use with up-mount overhead storage unit.
- For use with UniGroup and PLACES panels.

Height	Depth	Width	Number	Trim	
				A	B
60"(1524mm)	0.75"(19mm)	0.625"(16mm)	WT-60	\$268.80	\$282.19
72"(1829mm)			WT-72	315.58	328.97
84"(2134mm)			WT-84	362.36	375.75

Wall Mount Kit



WMK
Class AA

Features

- Includes wall-mount channel, hinges and screws.
- For mounting panels, with or without add-on panel, to a structural wall.
- Adds 0.25"(6mm) to the panel width.

To Order, Specify:

- 1) Product number.
- 2) Trim color.

Specification Tips

- Must be properly anchored to a structural wall.
- For use with UniGroup and PLACES panels.

Panel Height	Number	Trim	
		A	B
30"(762mm)	WMK-30	\$ 127.64	\$ 132.14
37"(940mm)	WMK-35	150.14	154.64
44"(1118mm)	WMK-42	181.64	186.14
50"(1270mm)	WMK-48	213.14	217.64
56"(1422mm)	WMK-54	235.64	240.14
64"(1626mm)	WMK-62	271.64	276.14
68"(1727mm)	WMK-66	294.14	298.64
82"(2083mm)	WMK-80	352.64	357.14

Panel Accessories

UniGroup

T-Mount Kit — Center and End Conditions

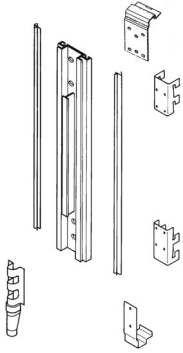

TMKT-B
Class AA

Features

- Includes pre-drilled side rail, center-mount brackets, end-mount brackets, light block extrusions, glide housing, and screws.
- Brackets included for both center- and end-mount T-conditions.
- Connects two panels in a T-condition. T-mount can attach to a base panel and one fabric add-on panel. Configuration coming off of a T-mount cannot contain add-on panels.

Specification Tips

- Both panels in a T-mount condition must be of equal height.
- Cannot mount on glazed panels, glazed add-on panels or doors.
- For use with UniGroup panels.

To Order, Specify:

- 1) Product number.
- 2) Trim color.

Panel Height	Number	Price
30"(762mm)	TMKT-28-B	\$ 378.65
37"(940mm)	TMKT-35-B	394.87
44"(1118mm)	TMKT-42-B	438.76
50"(1270mm)	TMKT-48-B	464.04
56"(1422mm)	TMKT-54-B	487.16
64"(1626mm)	TMKT-62-B	538.12
68"(1727mm)	TMKT-66-B	556.68
82"(2083mm)	TMKT-80-B	600.67

All-Purpose Hook



CH-8
Class AA

Features

- Includes eight hooks.
- Attaches to panel steel top cap.
- For use with UniGroup panels only.

To Order, Specify:

- 1) Product number.
- 2) Trim color.

Actual Height	Depth	Width	Number	Price
1"(25mm)	3"(76mm)	0.625"(16mm)	CH-8	\$208.45

Seismic Anchoring Bracket

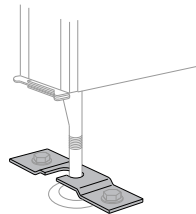

HAB
Class AC

Features

- Includes package of six formed steel brackets.
- For seismic anchoring of UniGroup Too and UniGroup panels.

Specification Tip

- For use with UniGroup Too, UniGroup and PLACES panels.

To Order, Specify:

- 1) Product number.
(No finish specification required.)

Number	Price
HAB-0001	\$366.36

Friction Pad

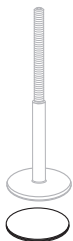

7031-0501
Class BA

Feature

- Includes one pad.

Specification Tips

- Attaches to bottom of glide to prevent movement of panels on hard surface flooring.
- For use with UniGroup and PLACES panels.

To Order, Specify:

- 1) Product number.
(No finish specification required.)

Number	Price
7031-0501	\$20.83

Panel Accessories – Retrofit Kits

UniGroup Too, UniGroup

Square Painted Top Caps

For UniGroup Too and UniGroup Fabric and Laminate Panels, UniGroup Too Fabric Add-On Panels and Legacy UniGroup Videne Panels

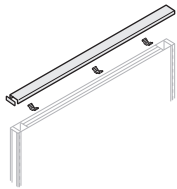

E2TS-U
Class AC

Feature

- Includes square painted top cap, clips, aligner, and .6 end caps.

Specification Tips

- To be used with straight top cap panels only.
- Not to be used with UniGroup expanded top cap raceway.

To Order, Specify:

- 1) Product number.
- 2) Trim color.

Width	Number	Trim	
		A	B
12"(305mm)	E2TS-12-U	\$ 93.35	\$ 95.44
18"(457mm)	E2TS-18-U	105.11	108.23
24"(610mm)	E2TS-24-U	118.83	122.98
30"(762mm)	E2TS-30-U	128.63	133.81
36"(914mm)	E2TS-36-U	140.39	146.60
42"(1067mm)	E2TS-42-U	152.15	159.39
48"(1219mm)	E2TS-48-U	165.87	174.14
54"(1372mm)	E2TS-54-U	175.67	184.97
60"(1524mm)	E2TS-60-U	189.39	199.72

Square Painted Top Caps

For UniGroup Too and UniGroup Doors and Glazed Panels, UniGroup Open-Frame Panels, UniGroup Too Glazed Add-On Panels, and UniGroup Glazed and Fabric Add-On Panels



E2TS-T
Class AC

Feature

- Includes square painted top cap, clips, aligner, and .6 end caps.

Specification Tips

- To be used with straight top cap panels only.
- Not to be used with UniGroup expanded top cap raceway.
- Field modification of glazed panels and doors manufactured prior to September 2007 as required.

To Order, Specify:

- 1) Product number.
- 2) Trim color.

Width	Number	Trim	
		A	B
12"(305mm)	E2TS-12-T	\$ 93.35	\$ 95.44
18"(457mm)	E2TS-18-T	105.11	108.23
24"(610mm)	E2TS-24-T	118.83	122.98
30"(762mm)	E2TS-30-T	128.63	133.81
36"(914mm)	E2TS-36-T	140.39	146.60
42"(1067mm)	E2TS-42-T	152.15	159.39
48"(1219mm)	E2TS-48-T	165.87	174.14
54"(1372mm)	E2TS-54-T	175.67	184.97
60"(1524mm)	E2TS-60-T	189.39	199.72

Trim Strip for UniGroup Fabric and Glazed Add-On Panels

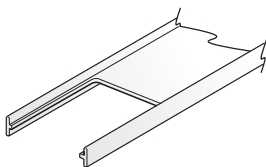

E2UR-A
Class AC

Feature

- Includes trim strip.

Specification Tip

- Used to retrofit existing fabric and glazed add-on panels to match aesthetic appearance of UniGroup Too.

To Order, Specify:

- 1) Product number.
- 2) Trim color.

Width	Number	Trim	
		A	B
12"(305mm)	E2UR-12-A	\$43.43	\$45.52
18"(457mm)	E2UR-18-A	48.86	51.98
24"(610mm)	E2UR-24-A	54.29	58.44
30"(762mm)	E2UR-30-A	59.72	64.90
36"(914mm)	E2UR-36-A	65.15	71.36
42"(1067mm)	E2UR-42-A	70.58	77.82
48"(1219mm)	E2UR-48-A	76.01	84.28
54"(1372mm)	E2UR-54-A	81.44	90.74
60"(1524mm)	E2UR-60-A	86.87	97.20

Panel Accessories – Retrofit Kits

UniGroup

90° Full-Height Finish Post — Square Painted Top Cap

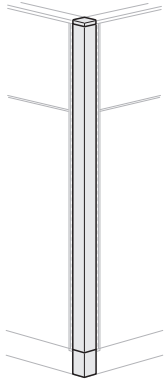

U2PC
Class AC

Feature

- Includes 90° vertical cover, square painted top cap and base raceway cover.

Specification Tips

- For use with equal height UniGroup panels in a 90°, 2-Way condition with UniGroup Too square painted top cap.
- To be used with straight top cap panels only.
- Required by UL for covering base raceway power connectors when power connector covers are not used.

To Order, Specify:

- 1) Product number:
- 2) Paint color for finish post.
- 3) Trim color for raceway cover.
- 4) Trim color for top cap.

Notes: For mixed grade trim surfaces pricing will be determined by the sum of the upcharges. Please refer to the electronic catalog.

Actual Height	Number	Trim	
		A	B
30"(762mm)	U2PC-28	\$ 176.75	\$ 194.09
37"(940mm)	U2PC-35	190.12	210.40
44"(1118mm)	U2PC-42	203.49	226.71
50"(1270mm)	U2PC-48	214.95	240.69
56"(1422mm)	U2PC-54	226.41	254.67
64"(1626mm)	U2PC-62	241.69	273.31
68"(1727mm)	U2PC-66	249.33	282.63
82"(2083mm)	U2PC-80	276.07	315.25

90° Variable-Height Finish Post — Square Painted Top Cap

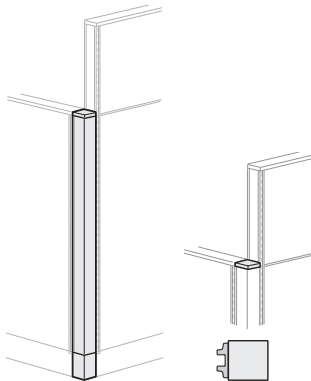

U2PC-V
Class AC

Feature

- Includes 90° vertical cover, square painted top cap and base raceway cover.

Specification Tips

- For use with multiple height UniGroup panels in a 90°, 2-Way condition; specify height to match lowest panel height with UniGroup Too square painted top cap.
- To be used with straight top cap panels only.
- Required by UL for covering base raceway power connectors when power connector covers are not used.

To Order, Specify:

- 1) Product number:
- 2) Paint color for finish post.
- 3) Trim color for raceway cover.
- 4) Trim color for top cap.

Note: For mixed grade trim surfaces pricing will be determined by the sum of the upcharges. Please refer to the electronic catalog.

Actual Height	Number	Trim	
		A	B
30"(762mm)	U2PC-28-V	\$204.97	\$222.31
37"(940mm)	U2PC-35-V	218.34	238.62
44"(1118mm)	U2PC-42-V	231.71	254.93
50"(1270mm)	U2PC-48-V	243.17	268.91
56"(1422mm)	U2PC-54-V	254.63	282.89
64"(1626mm)	U2PC-62-V	269.91	301.53
68"(1727mm)	U2PC-66-V	277.55	310.85

Panel Accessories – Retrofit Kits

UniGroup

120° Full-Height Finish Post — Square Painted Top Cap

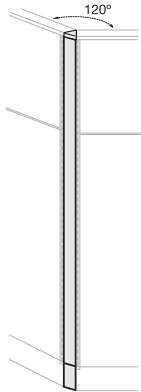

U2PA
Class AC

Feature

- Includes 120° vertical cover, square painted top cap and base raceway cover.

Specification Tips

- For use with equal height UniGroup panels in a 120°, 2-Way condition with UniGroup Too square painted top cap.
- To be used with straight top cap panels only.
- Required by UL for covering base raceway power connectors when power connector covers are not used.

To Order, Specify:

- 1) Product number:
- 2) Paint color for finish post.
- 3) Trim color for raceway cover.
- 4) Trim color for top cap.

Note: For mixed grade trim surfaces pricing will be determined by the sum of the upcharges. Please refer to the electronic catalog.

Actual Height	Number	Trim	
		A	B
30"(762mm)	U2PA-28	\$220.67	\$234.10
37"(940mm)	U2PA-35	231.52	247.96
44"(1118mm)	U2PA-42	242.37	261.82
50"(1270mm)	U2PA-48	251.67	273.70
56"(1422mm)	U2PA-54	260.97	285.58
64"(1626mm)	U2PA-62	273.37	301.42
68"(1727mm)	U2PA-66	279.57	309.34
82"(2083mm)	U2PA-80	301.27	337.06

120° Variable-Height Finish Post — Square Painted Top Cap

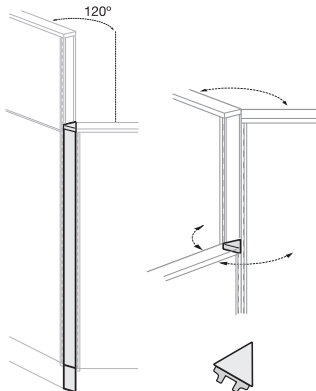

U2PA-V
Class AC

Feature

- Includes 120° vertical cover, square painted top cap and base raceway cover.

Specification Tips

- For use with multiple height UniGroup panels in a 120°, 2-Way condition; specify height to match lowest panel height with UniGroup Too square painted top cap.
- To be used with straight top cap panels only.
- Required by UL for covering base raceway power connectors when power connector covers are not used.

To Order, Specify:

- 1) Product number:
- 2) Paint color for finish post.
- 3) Trim color for raceway cover.
- 4) Trim color for top cap.

Note: For mixed grade trim surfaces pricing will be determined by the sum of the upcharges. Please refer to the electronic catalog.

Actual Height	Number	Trim	
		A	B
30"(762mm)	U2PA-28-V	\$248.67	\$262.10
37"(940mm)	U2PA-35-V	259.52	275.96
44"(1118mm)	U2PA-42-V	270.37	289.82
50"(1270mm)	U2PA-48-V	279.67	301.70
56"(1422mm)	U2PA-54-V	288.97	313.58
64"(1626mm)	U2PA-62-V	301.37	329.42
68"(1727mm)	U2PA-66-V	307.57	337.34

Panel Accessories – Retrofit Kits

UniGroup

180° Full-Height Finish Post — Square Painted Top Cap

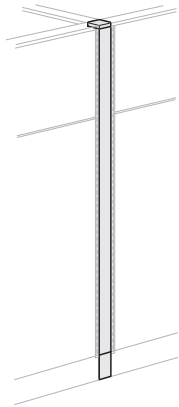

U2PS
Class AC

Feature

- Includes 180° vertical cover, square painted top cap and base raceway cover.

Specification Tips

- For use with equal height UniGroup panels in a 180°, 3-Way condition with UniGroup Too square painted top cap.
- To be used with straight top cap panels only.
- Required by UL for covering base raceway power connectors when power connector covers are not used.

To Order, Specify:

- 1) Product number:
- 2) Paint color for finish post.
- 3) Trim color for raceway cover.
- 4) Trim color for top cap.

Note: For mixed grade trim surfaces pricing will be determined by the sum of the upcharges. Please refer to the electronic catalog.

Actual Height	Number	Trim	
		A	B
30"(762mm)	U2PS-28	\$ 173.34	\$ 190.72
37"(940mm)	U2PS-35	187.42	208.32
44"(1118mm)	U2PS-42	197.98	221.52
50"(1270mm)	U2PS-48	208.54	234.72
56"(1422mm)	U2PS-54	219.10	247.92
64"(1626mm)	U2PS-62	233.18	265.52
68"(1727mm)	U2PS-66	240.22	274.32
82"(2083mm)	U2PS-80	264.86	305.12

180° Variable-Height Finish Post — Square Painted Top Cap

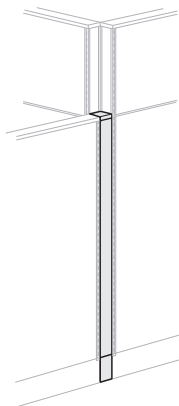

U2PS-V
Class AC

Features

- Includes 180° vertical cover, square painted top cap and base raceway cover.
- Includes top cap with one or two alignment tabs; specify accordingly.

Specification Tips

- For use with multiple height UniGroup panels in a 180°, 3-Way condition with UniGroup Too square painted top cap; specify height to match lowest panel height except in V2l condition.
- To be used with straight top cap panels only.
- Product specification must reflect number of top cap alignment tabs for lowest like panel heights in an "I" or "L" condition; refer to UniGroup Too Application Guidelines.
- Top cap alignment tabs are for dedicated applications and are not field removable; -V1, -V2l, -V2L.
- Required by UL for covering base raceway power connectors when power connector covers are not used.

To Order, Specify:

- 1) Product number:
- 2) Paint color for finish post.
- 3) Trim color for raceway cover.
- 4) Trim color for top cap.

Note: For mixed grade trim surfaces pricing will be determined by the sum of the upcharges. Please refer to the electronic catalog.

Actual Height	Number	Trim	
		A	B
30"(762mm)	U2PS-28-V1	\$ 201.34	\$ 218.72
	U2PS-28-V2l	201.34	218.72
	U2PS-28-V2L	201.34	218.72
37"(940mm)	U2PS-35-V1	\$ 215.42	\$ 236.32
	U2PS-35-V2l	215.42	236.32
	U2PS-35-V2L	215.42	236.32
44"(1118mm)	U2PS-42-V1	\$ 225.98	\$ 249.52
	U2PS-42-V2l	225.98	249.52
	U2PS-42-V2L	225.98	249.52
50"(1270mm)	U2PS-48-V1	\$ 236.54	\$ 262.72
	U2PS-48-V2l	236.54	262.72
	U2PS-48-V2L	236.54	262.72
56"(1422mm)	U2PS-54-V1	\$ 247.10	\$ 275.92
	U2PS-54-V2l	247.10	275.92
	U2PS-54-V2L	247.10	275.92
64"(1626mm)	U2PS-62-V1	\$ 261.18	\$ 293.52
	U2PS-62-V2l	261.18	293.52
	U2PS-62-V2L	261.18	293.52
68"(1727mm)	U2PS-66-V1	\$ 268.22	\$ 302.32
	U2PS-66-V2l	268.22	302.32
	U2PS-66-V2L	268.22	302.32
82"(2083mm)	U2PS-80-V2l	\$ 292.86	\$ 333.12

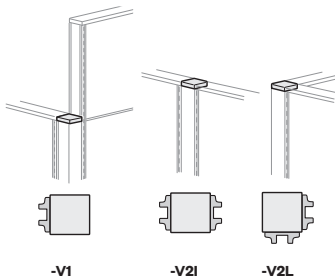

Panel Accessories – Retrofit Kits

PLACES

Square Painted Top Caps



E2TS-P
Class AC

Feature

- Includes square painted top cap, clips, aligner, and .6 end caps.

Specification Tips

- For all PLACES doors and panel types except Legacy Gabled, Oblique and Expanded
- To be used with straight top cap panels only.
- Field modification of glazed panels and doors manufactured prior to September 2007 as required.

To Order, Specify:

- 1) Product number.
- 2) Trim color.

Width	Number	Trim	
		A	B
12"(305mm)	E2TS-12-P	\$ 93.35	\$ 95.44
18"(457mm)	E2TS-18-P	105.11	108.23
24"(610mm)	E2TS-24-P	118.83	122.98
30"(762mm)	E2TS-30-P	128.63	133.81
36"(914mm)	E2TS-36-P	140.39	146.60
42"(1067mm)	E2TS-42-P	152.15	159.39
48"(1219mm)	E2TS-48-P	165.87	174.14
54"(1372mm)	E2TS-54-P	175.67	184.97
60"(1524mm)	E2TS-60-P	189.39	199.72

90° Full-Height Finish Post — Square Painted Top Cap

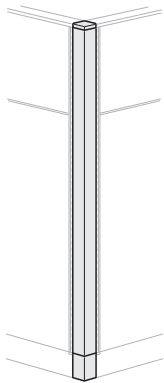

H2PC
Class AC

Feature

- Includes 90° vertical cover, square painted top cap and base raceway cover.

Specification Tips

- For use with equal height PLACES panels in a 90°, 2-Way condition with UniGroup Too square painted top cap.
- Not for use with legacy expanded panels.
- To be used with straight top cap panels only.
- Required by UL for covering base raceway flexible and Straight power connectors when power connector covers are not used.

To Order, Specify:

- 1) Product number;
- 2) Paint color for finish post.
- 3) Trim color for raceway cover.
- 4) Trim color for top cap.

Note: For mixed grade trim surfaces pricing will be determined by the sum of the upcharges. Please refer to the electronic catalog.

Actual Height	Number	Trim	
		A	B
30"(762mm)	H2PC-30	\$204.76	\$222.94
37"(940mm)	H2PC-37	218.13	239.25
44"(1118mm)	H2PC-44	231.50	255.56
50"(1270mm)	H2PC-50	242.96	269.54
56"(1422mm)	H2PC-56	254.42	283.52
64"(1626mm)	H2PC-64	269.70	302.16
68"(1727mm)	H2PC-68	277.34	311.48
82"(2083mm)	H2PC-82	304.08	344.10

90° Variable-Height Finish Post — Square Painted Top Cap

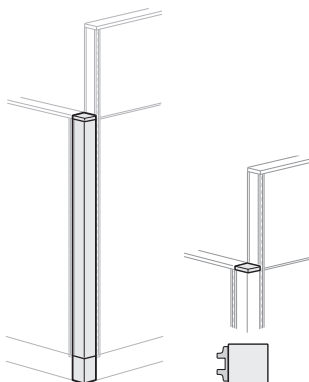

H2PC-V
Class AC

Feature

- Includes 90° vertical cover, square painted top cap and base raceway cover.

Specification Tips

- For use with multiple height PLACES panels in a 90°, 2-Way condition; specify height to match lowest panel height with UniGroup Too square painted top cap.
- Not for use with legacy expanded panels.
- To be used with straight top cap panels only.
- Required by UL for covering base raceway power connectors when power connector covers are not used.

To Order, Specify:

- 1) Product number;
- 2) Paint color for finish post.
- 3) Trim color for raceway cover.
- 4) Trim color for top cap.

Note: For mixed grade trim surfaces pricing will be determined by the sum of the upcharges. Please refer to the electronic catalog.

Actual Height	Number	Trim	
		A	B
30"(762mm)	H2PC-30-V	\$232.98	\$ 251.16
37"(940mm)	H2PC-37-V	246.35	267.47
44"(1118mm)	H2PC-44-V	259.72	283.78
50"(1270mm)	H2PC-50-V	271.18	297.76
56"(1422mm)	H2PC-56-V	282.64	311.74
64"(1626mm)	H2PC-64-V	297.92	330.38
68"(1727mm)	H2PC-68-V	305.56	339.70

Panel Accessories – Retrofit Kits

PLACES

180° Full-Height Finish Post — Square Painted Top Cap

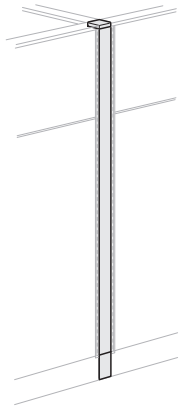

H2PS
Class AC

Feature

- Includes 180° vertical cover, top cap and base raceway cover.

Specification Tips

- For use with equal height PLACES panels in a 180°, 3-Way condition with UniGroup Too square painted top cap.
- Not for use with legacy expanded panels.
- To be used with straight top cap panels only.
- Required by UL for covering base raceway power connectors when power connector covers are not used.

To Order, Specify:

- 1) Product number:
- 2) Paint color for finish post.
- 3) Trim color for raceway cover.
- 4) Trim color for top cap.

Note: For mixed grade trim surfaces pricing will be determined by the sum of the upcharges. Please refer to the electronic catalog.

Actual Height	Number	Trim	
		A	B
30"(762mm)	H2PS-30	\$ 190.93	\$209.19
37"(940mm)	H2PS-37	205.01	226.79
44"(1118mm)	H2PS-44	215.57	239.99
50"(1270mm)	H2PS-50	226.13	253.19
56"(1422mm)	H2PS-56	236.69	266.39
64"(1626mm)	H2PS-64	250.77	283.99
68"(1727mm)	H2PS-68	257.81	292.79
82"(2083mm)	H2PS-82	282.45	323.59

180° Variable-Height Finish Post — Square Painted Top Cap

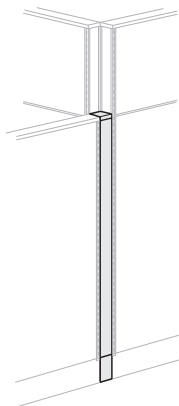

H2PS-V
Class AC

Features

- Includes 180° vertical cover, square painted top cap and base raceway cover.
- Includes top cap with one or two alignment tabs; specify accordingly.

Specification Tips

- For use with multiple height PLACES panels in a 180°, 3-Way condition with UniGroup Too square painted top cap; specify height to match lowest panel height except in V2I condition.
- Not for use with legacy expanded panels.
- To be used with straight top cap panels only.
- Product specification must reflect number of top cap alignment tabs for lowest like panel heights in an "I" or "L" condition; refer to UniGroup Too Application Guidelines.
- Top cap alignment tabs are for dedicated applications and are not field removable; -V1, -V2I, -V2L.
- Required by UL for covering base raceway power connectors when power connector covers are not used.

To Order, Specify:

- 1) Product number:
- 2) Paint color for finish post.
- 3) Trim color for raceway cover.
- 4) Trim color for top cap.

Notes: For mixed grade trim surfaces pricing will be determined by the sum of the upcharges. Please refer to the electronic catalog.

Actual Height	Number	Trim	
		A	B
30"(762mm)	H2PS-30-V1	\$ 218.93	\$ 237.19
	H2PS-30-V2I	218.93	237.19
	H2PS-30-V2L	218.93	237.19
37"(940mm)	H2PS-37-V1	\$233.01	\$254.79
	H2PS-37-V2I	233.01	254.79
	H2PS-37-V2L	233.01	254.79
44"(1118mm)	H2PS-44-V1	\$243.57	\$ 267.99
	H2PS-44-V2I	243.57	267.99
	H2PS-44-V2L	243.57	267.99
50"(1270mm)	H2PS-50-V1	\$254.13	\$ 281.19
	H2PS-50-V2I	254.13	281.19
	H2PS-50-V2L	254.13	281.19
56"(1422mm)	H2PS-56-V1	\$264.69	\$294.39
	H2PS-56-V2I	264.69	294.39
	H2PS-56-V2L	264.69	294.39
64"(1626mm)	H2PS-64-V1	\$278.77	\$ 311.99
	H2PS-64-V2I	278.77	311.99
	H2PS-64-V2L	278.77	311.99
68"(1727mm)	H2PS-68-V1	\$285.81	\$320.79
	H2PS-68-V2I	285.81	320.79
	H2PS-68-V2L	285.81	320.79
82"(2083mm)	H2PS-82-V2I	\$ 310.45	\$ 351.59

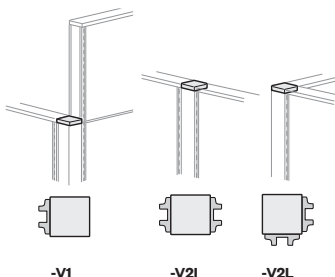

Clerestory Kits

UniGroup Too, UniGroup

Clerestory Illustration

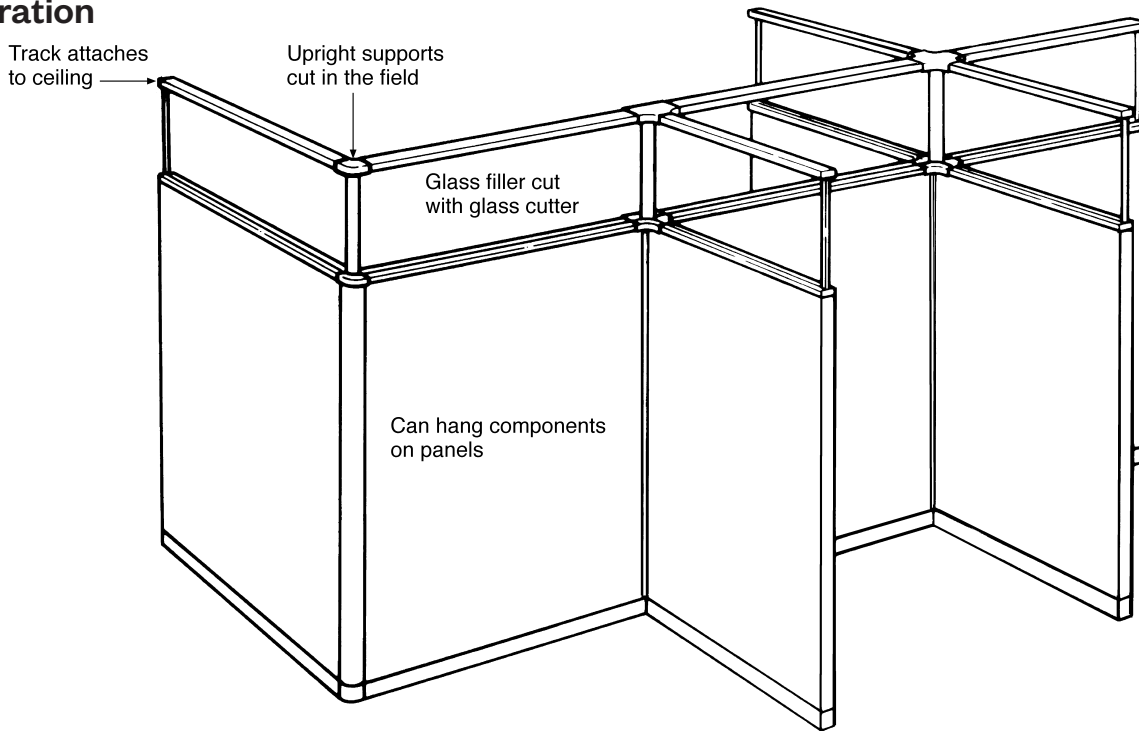

Planning and Specification

1. To determine how many lineal feet of straight track are needed, divide the total lineal feet of panels that require Clerestory by ten and round-off to the next highest whole number. Order that quantity of Straight Track SPCL-1616.
2. Examine your floor plan to determine the type and quantities of corner kits you will require. Note that only 90° angles are possible; other angles cannot be accommodated.
3. If mounting Clerestory on straight panel runs that include swing doors or glazed panels, a maximum combination of four lineal feet of glazed panels or glazed panels with a door is permitted per 12'(3658mm) panel run.
4. Follow normal support and load values for UniGroup Too and UniGroup panels as defined in Haworth Installation Procedures.
5. Be sure that sprinkler, HVAC and lighting locations are taken into consideration when planning for Clerestory; it does form a floor-to-ceiling barrier.
6. Consult Installation Instructions #7021-6201 for specific installation information.

Notes:

- Installation instructions available in the Library. Please refer to prior to ordering field supplied glass.
- Not to be used with top feed modules.
- Not to be used with sliding doors.
- Ceiling bracket designed to fit 1"(25mm) grid.
- **For UniGroup Too applications, 90° finish posts must be replaced with UniGroup 90° finish posts so radius aesthetic matches 2-way corner pieces. Field cut to size.**

Code Compliance

Where Clerestory is used with UniGroup Too and UniGroup panels that feature The Power Base electrical system, electrical components do not comply with UL 183 requirements for floor-to-ceiling partitions; the electrical components do comply with UL 1286 requirements for panel systems. Verify acceptance of this exception and check local codes.

Application Guidelines

- Clerestory is designed to be used with 80"(2032mm) or 82"(2083mm)H UniGroup Too and UniGroup panels where there is a maximum ceiling height of 10'(3048mm), OR with 64"(1626mm) or 68"(1727mm)H panels where there is a maximum ceiling height of 9'(2743mm). Be sure that Clerestory complies with local building codes before ordering and installing the product.
- All aluminum and plastic components (such as corner moldings) are available color-matched to UniGroup Too and UniGroup panel trim colors. **Not available in Metallic finishes.**
- Note: Laminated safety glass is required for use in all Clerestory applications; consult installation instructions glass specification directions (purchase all required glass locally).
- Minimum thickness of glass is 0.220"(6mm).
- Maximum thickness of glass is 0.275"(7mm).
- Glass panes should not exceed 5'(1524mm) in width.

Clerestory Kits

UniGroup Too, UniGroup

Straight Track Kit

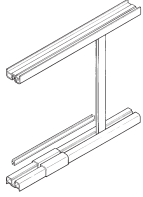

SPCL-1616
Class AA

Features

- Includes two 10'(3048mm) lengths of extruded aluminum, painted ceiling and panel track; two (2) 10'(3048mm) lengths of "H" spacer; extruded aluminum, painted vertical connectors; four (4) couplers; and hardware.
- To determine the amount of lineal feet of straight track needed, divide the total lineal feet of panels that require Clerestory by 10 and round off to the next highest whole number. Order that quantity of straight track.

To Order, Specify:

- 1) Product number.
- 2) Trim color.

Number

SPCL-1616

Price

\$1202.05

2-Way Connector Kit

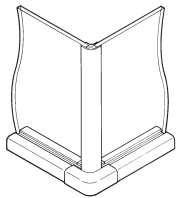

SPCL-1613
Class AA

Feature

- Includes one 4'(1219mm) length of connector post and corner moldings for panel and ceiling.

Specification Tip

- Use with UniGroup 90° finish posts only.

To Order, Specify:

- 1) Product number.
- 2) Trim color.

Number

SPCL-1613

Vertical

Price

\$187.61

3-Way Connector Kit

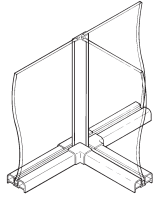

SPCL-1614
Class AA

Feature

- Includes one 4'(1219mm) length of connector post and corner moldings for panel and ceiling.

To Order, Specify:

- 1) Product number.
- 2) Trim color.

Number

SPCL-1614

Vertical

Price

\$203.82

4-Way Connector Kit

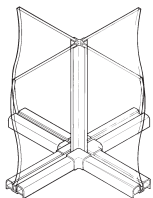

SPCL-1615
Class AA

Feature

- Includes one 4'(1219mm) length of connector post and corner moldings for panel and ceiling.

To Order, Specify:

- 1) Product number.
- 2) Trim color.

Number

SPCL-1615

Vertical

Price

\$224.66

End Kit

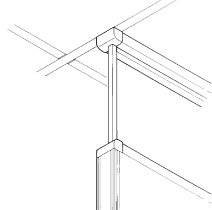

SPCL-1622
Class AA

Feature

- Includes one 4'(1219mm) length of end trim post and panel end cap molding.

To Order, Specify:

- 1) Product number.
- 2) Trim color.

Number

SPCL-1622

Vertical

Price

\$113.49

Electrical Components

UniGroup Too, UniGroup

Base Feed Module – Hardwire Connection

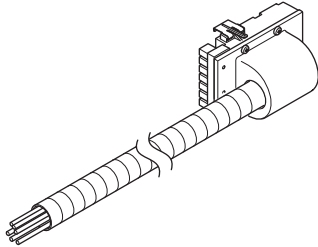

BFM-1-B
Class AA



Features

- Includes one base feed with 4'(1219mm) long, with black 0.5"(13mm) flexible metal conduit.
- Conduit for 3-Circuit includes eight 12-gauge wires for up to three 20 amp circuits of power.
- For floor, column, or wall hardwire connections.
- For use with panels equipped with power components.
- Base feed module can be field modified to accommodate left or right conditions.
- Attaches at any one of the four receptacle sites in a powered base raceway of a panel.
- Standard in charcoal trim color only.

Specification Tips

- For use with UniGroup Too and UniGroup.
- Not for use with power sources other than 120 volt 60 hertz.
- Application may require approval of local authority having jurisdiction (AHJ); ensure compliance before placing orders and installation.

To Order, Specify:

- 1) Product number.
(No finish specification required.)

Description	Feed Length	Number	Price
3-Circuit Hardwire 20 Amp	48"(1219mm)	BFM-1-B	\$ 496.27
	72"(1829mm)	BFM-0006-B	667.29
	120"(3048mm)	BFM-0010-B	865.34
	180"(4572mm)	BFM-0015-B	1136.42
	300"(7620mm)	BFM-0025-B	1630.60

Single Circuit Base Feed Module – Receptacle Connection with Power Cord

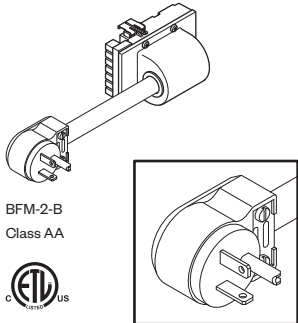

BFM-2-B
Class AA



Features

- Includes one base feed, 2'(610mm) cord and 20 amp plug (NEMA 5-20P).
- For use with panels equipped with power components.
- Requires a 20 amp, 125 volt power receptacle (NEMA 5-20R) for plug-in (not included).
- Provides power to circuit #1 only.
- Attaches at any of the four receptacle sites in a powered base raceway of a panel.
- Standard in charcoal trim color only.

Specification Tips

- For use with UniGroup Too and UniGroup.
- **Not for use in Canada due to electrical code restrictions.**
- **Not for use with isolated ground receptacles.**
- Not for use with power sources other than 120 volt 60 hertz.
- Application may require approval of local authority having jurisdiction (AHJ); ensure compliance before placing orders and installation.

To Order, Specify:

- 1) Product number.
(No finish specification required.)

Description	Feed Length	Number	Price
3-Circuit Cord Feed 20 Amp (USA Only)	2'(610mm)	BFM-2-B	\$468.44

Electrical Components

UniGroup Too, UniGroup

Single Circuit Base Feed Module – Receptacle Connection with Power Cord

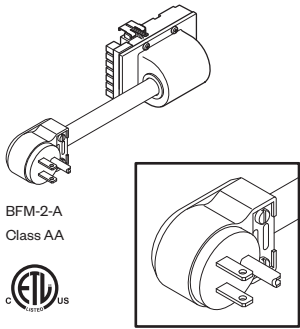

BFM-2-A
Class AA



Features

- Includes one base feed, 6'(1829mm) cord, and 15 amp plug (NEMA 5-15P).
- For use with panels equipped with power components.
- Requires a 15 amp, 125 volt power receptacle (NEMA 5-15R) for plug-in (not included).
- Attaches at any one of four receptacle sites in a powered raceway of a panel.
- Provides power to circuit #1 only.
- Standard in charcoal trim color only.

Specification Tips

- For use with UniGroup Too and UniGroup.
- **Not for use in USA due to electrical code restrictions.**
- **Not for use with isolated ground receptacles.**
- Not for use with power sources other than 120 volt 60 hertz.
- Application may require approval of local authority having jurisdiction (AHJ); ensure compliance before placing orders and installation.

To Order, Specify:

- 1) Product number.
(No finish specification required.)

Description	Feed Length	Number	Price
3-Circuit Cord Feed 15 Amp (Canada Only)	6'(1829mm)	BFM-2-A	\$449.21

Base Feed Module — Concealed Hardwire Connection

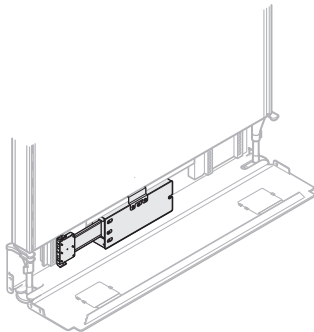

BFM-6-B
Class AA



Features

- Includes one junction box with modular connector and three 0.5"(13mm) knockouts.
- For use with panels equipped with power components.
- For floor, column, or wall hardwire connections.
- For 3-Circuit includes eight 12-gauge wires for up to three 20 amp circuits of power.
- Attaches into receptacle site on left side of panel.
- Conforms to New York City electrical code.
- Junction box has three 0.5"(13mm) knockouts.

Specification Tips

- For use with UniGroup Too and UniGroup.
- For installation on panels **no less than 30"(762mm)W**.
- Conduit and fittings for connection between building and junction box are supplied by local electricians.
- Application may require approval of local authority having jurisdiction (AHJ); ensure compliance before placing orders and installation.

To Order, Specify:

- 1) Product number.
(No finish specification required.)

Description	Number	Price
3-Circuit Concealed	BFM-6-B	\$504.57

Electrical Components

UniGroup Too, UniGroup

Raised Floor Base Feed Module

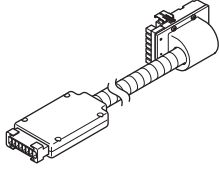

EBEJ-0072-3WF
Class AA



Features

- Includes connector assembly which consists of one Power Base connector head, 0.5”(13mm) black flexible metal conduit and one Power Base AI connector and a two port splitter.
- Eight 12-gauge wires provided up to three 20-amp circuits for 3-circuit.
- For use with power components.
- Attaches at any one of the four receptacle sites in a powered base raceway of a panel and to a Power Base AI underfloor power system or a Power Base AI Wall feed.
- Base feed module can be field modified to accommodate left or right conditions.
- Connector has integral latching system.
- UL listed manufactured wiring system rated for 20-amp 120V/208Y or 120V/240V 60 Hz and for use in “other air handling spaces” per the NEC article 604.
- Standard in charcoal trim color only.

Specification Tips

- For use with UniGroup Too and UniGroup.
- Male Power Base AI connector can plug directly into a zone distribution box, circuit distributor, flush floor box connectors or wall feed.
- Male Power Base AI connector cannot connect directly to infeed or jumper.
- Not for power sources other than 120 volt 60 hertz.
- Application may require approval of local authority having jurisdiction (AHJ); ensure compliance before placing orders and installation.

To Order, Specify:

- 1) Product number.
(No finish specification required.)

Description	Feed Length	Number	Price
3-Circuit Infeed Connector	69”(1753mm)	EBEJ-0072-3WF	\$653.83

Internal Power Base AI Feed

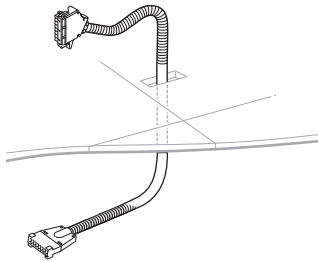

EVEJ-3WF
Class YA



Features

- Includes connector assembly which consists of one power base connector head, 0.5”(13mm) (unpainted) flexible metal conduit and one Power Base AI connector for up to three circuits of power and a two port splitter.
- Attaches at any one of the four receptacle sites in a powered base raceway of a panel and to a Power Base AI underfloor power system.

Specification Tips

- **Not for use with power sources other than 120 volt 60 hertz.**
- Male Power Base AI connector can plug directly into a zone distribution box, circuit distributor, flush floor box connectors or wall feed.
- Male Power Base AI connector cannot connect directly to infeed or jumper.
- Excess length can be coiled under the floor.
- Application may require approval of local authority having jurisdiction (AHJ); ensure compliance before placing orders and installation.

To Order, Specify:

- 1) Product number.
(No finish specification required.)

Description	Length	Number	Price
3-Circuit	64”(1626mm)	EUEJ-0064-3WF	\$346.75
	102”(2591mm)	EUEJ-0102-3WF	389.86
	144”(3658mm)	EUEJ-0144-3WF	454.57
	300”(7620mm)	EUEJ-0300-3WF	988.29

Electrical Components

UniGroup Too, UniGroup

Wall Feed Field Wired 1 Port

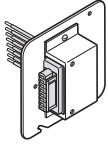

FBEW
Class YA



Features

- Includes 4.69" (119mm) junction box cover with one female modular power connector.
- For use with field supplied 4.69" (119mm) square junction box.
- For use with Raised Floor Base Feed Module and Internal Power Base AI feed.
- Connector has integral latching system.
- UL listed manufactured wiring system rated for 20 AMP 120V/20BY or 120/240V 60 Hz and for use in other air.

Specification Tips

- Provides transition from building power to modular power distribution system. May be used with junction box in wall or column.

To Order, Specify:

- 1) Product number.
(No finish specification required.)

Description	Height	Length	Number	Price
3-Circuit	1.5"(38mm)	4.69"(119mm)	FBEW-0004-31	\$163.32

Infeed Harness

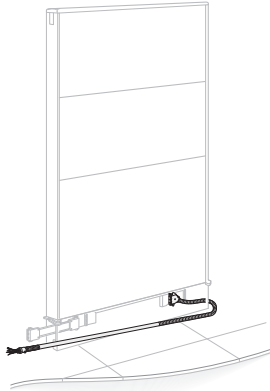

VEEH-3
Class AC



Features

- Includes electrical harness in metal conduit.
- For connection to the electrical source located in space above a drop ceiling or from floor.
- For use with panels equipped with power components.
- Electrical harness contained in metal conduit allows for adjacent routing of communication cabling within the pole.
- Conduit for 3-Circuit includes eight 12-gauge wires for up to three 20-amp circuits of power.
- Routes power to base raceway.
- Attaches to receptacle site on right hand side of panel in a powered raceway.

Specification Tips

- For use with UniGroup Too and UniGroup.
- Not for use with power sources other than 120 volt 60 hertz.
- Application may require approval of local authority having jurisdiction (AHJ); ensure compliance before placing orders and installation.

To Order, Specify:

- 1) Product number.
(No finish specification required.)

Description	Length	Number	Price
3-Circuit	15'(4572mm)	VEEH-0000-3	\$1045.79
	30'(9144mm)	VEEH-0030-3	1602.80

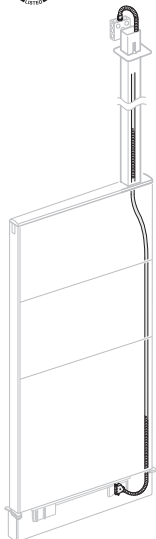

Electrical Components

UniGroup Too

Top Feed Module

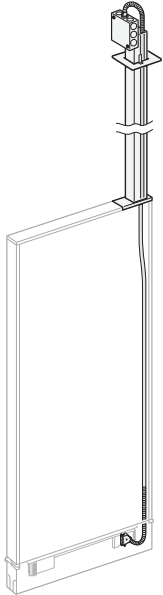

E2FM
E2FM-X
Class AC



Features

- Includes one electrical harness in metal conduit, electrical box, ceiling bezel plate, single channel pole, hardware and square painted top cap cover.
- For connection to the electrical source located in space above a drop ceiling.
- For use with panels equipped with power components.
- Electrical harness contained in metal conduit allows for adjacent routing of communication cabling within the pole.
- Conduit for 3-Circuit includes eight 12-gauge wires for up to three 20-amp circuits of power.
- For routing and cabling capacities, see Specification Guide.
- Removable cover on pole provides access to pathway.
- Provides eight 12-gauge wires for up to three 20-amp circuits of power.
- Routes power to base raceway.
- Attaches at receptacle site on right hand side of panel in a powered base raceway.

Specification Tips

- For installation on panels no less than 18”(457mm)W.
- Not for use with glazed add-on panels, glazed panels or single doors.
- For use with UniGroup Too square painted top cap panels only, field cutting of top cap is required.
- Not for use with power sources other than 120 volt 60 hertz.
- Application may require approval of local authority having jurisdiction (AHJ); ensure compliance before placing orders and installation.

NOTE: Wire harness length is 180”(4572mm) regardless of pole length.

To Order, Specify:

- 1) Product number.
- 2) Trim color for pole.
- 3) Trim color top cap piece.

Description	Panel Height	Pole Length	Number	Trim	
				A	B
10' Ceiling Height					
3-Circuit	32”(813mm) - 56”(1422mm)	124”(3150mm)	E2FM-3200-3	\$2159.41	\$2225.71
	64”(1626mm) - 80”(2032mm)	70”(1778mm)	E2FM-6400-3	2107.32	2137.35
12' Ceiling Height					
3-Circuit	40”(1016mm) - 80”(2032mm)	124”(3150mm)	E2FM-X	\$2159.41	\$2225.71

Electrical Components

UniGroup

Top Feed Module

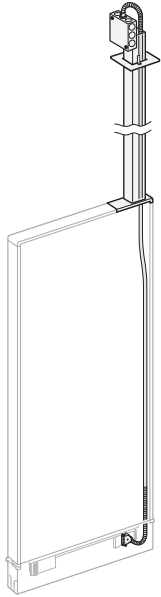

TFM-B
TFM-X
Class AA



Features

- Includes one electrical harness in metal conduit, electrical box, ceiling bezel plate, single channel pole, hardware and radius top cap cover.
- For connection to the electrical source located in space above a drop ceiling.
- For use with panels equipped with power components.
- Electrical harness contained in metal conduit allows for adjacent routing of communication cabling within the pole.
- For routing and cabling capacities, see Specification Guide.
- Removable cover on poles provides access to pathway.
- Conduit for 3-Circuit includes eight 12-gauge wires for up to three 20-amp circuits of power.
- Routes power to base raceway.
- Attaches to receptacle site on right hand side of panel in a powered raceway.

Specification Tips

- For installation on panels no less than 18"(457mm)W.
- For use with UniGroup panels only.
- Not for use with glazed add-on panels, glazed and open frame panels or single doors.
- For use with UniGroup radius steel top cap, field cutting of top cap is required. When used with UniGroup radius wood top cap, access hole must be cut into top cap.
- Not for use with power sources other than 120 volt 60 hertz.
- Application may require approval of local authority having jurisdiction (AHJ); ensure compliance before placing orders and installation.

NOTE: Wire harness length is 180"(4572mm) regardless of pole length.

To Order, Specify:

- 1) Product number.
- 2) Trim color for pole.
- 3) Trim color for top cap piece.

Description	Panel Height	Pole Length	Number	Price
10' Ceiling Height				
3-Circuit	30"(762mm) - 56"(1422mm)	124"(3150mm)	TFM-3000-B	\$2595.56
	64"(1626mm) - 82"(2083mm)	70"(1778mm)	TFM-6400-B	2572.08
12' Ceiling Height				
3-Circuit	37"(940mm) - 82"(2083mm)	124"(3150mm)	TFM-X-B	\$2595.56

Electrical Components

UniGroup Too, UniGroup

Flexible Power Connector — Panel-to-Panel

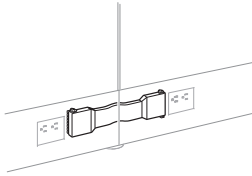

Features

- Includes one flexible power connector with safety latches for securing connector to power block.
- Continues electrical circuit between adjacent powered panels in straight or angled conditions.
- Finish post or power connector cover is required by UL for covering flexible power connector.
- For use with panels equipped with power components.
- .95 Flexible Connectors shipped per powered panel specified.
- Standard in charcoal finish color only.

Specification Tips

- For use with UniGroup Too and UniGroup.
- Not for use with power sources other than 120 volt 60 hertz.

To Order, Specify:

- 1) Product number.
(No finish specification required.)

Description	Length	Number	Price
3-Circuit	8"(203mm)	PCF-3-B	\$263.01

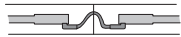

Base straight condition

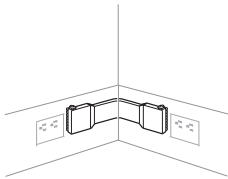

Panel outside 90° condition

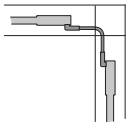

PCF-3-B
Class AA



Electrical Components

UniGroup Too, UniGroup

Flexible Power Connector — Straight Span

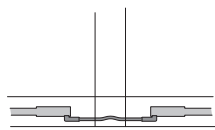
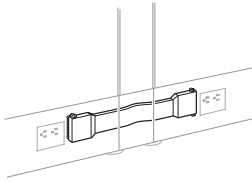

Panel three-way or four-way condition

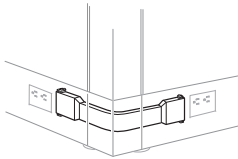

Panel outside 90° condition

PCSS-3-B
Class AA



Features

- Includes one straight-span flexible power connector with safety latches for securing connector to power block.
- Continues electrical circuit across the 2”(51mm) space between powered panels in a 3-way, 4-way or outside 90° condition in the base raceway.
- Retaining clips attached.
- For use with panels equipped with power components.
- Finish post or power connector cover is required by UL for covering straight-span power connector.
- Standard in charcoal finish color only.

Specification Tips

- For use with UniGroup Too and UniGroup.
- Straight span flexible power connector must be separately specified and is not included with panel.
- Not for use with power sources other than 120 volt 60 hertz.

To Order, Specify:

- 1) Product number.
(No finish specification required.)

Description	Length	Number	Price
3-Circuit	10.125”(257mm)	PCSS-3-B	\$231.60

Connector Assembly – 12” Pass-Through

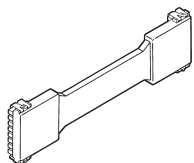

PCOF-1-B
Class AA



Features

- Includes one flexible power connector with safety latches for securing connector to power block.
- Used to pass power through a 12”(305mm)W panel and a 3-way or 4-way condition.
- Connector is provided with 12”(305mm) powered panel.
- For use with panels equipped with power components.

Specification Tips

- For use with UniGroup Too and UniGroup.
- Designed for in line use only.
- Not for use with power sources other than 120 volt 60 hertz.

To Order, Specify:

- 1) Product number.
(No finish specification required.)

Description	Length	Number	Price
3-Circuit	20”(508mm)	PCOF-1-B	\$250.13

Electrical Components

UniGroup Too, UniGroup

Duplex Receptacle – 15 Amp

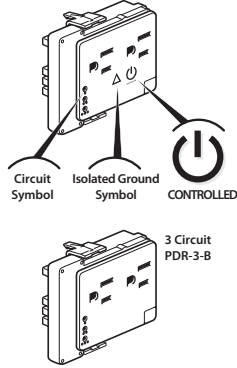

PRD-3-B
PRDI-5-B
Class AA

Circuit Symbol	Circuit 1	Circuit 2	Circuit 3	Circuit 4
3 Circuit	0	00	000	NA

Features

- Includes box of six receptacles, each receptacle has two 15 Amp outlets (NEMA 5-15R configuration).
- For use with panels equipped with power components.
- **Receptacles are ground type specific.**

Specification Tips

- Duplex for 3-Circuit are field programmable.
- For power access at any location within the panels with appropriate base raceway covers.
- Not for use with power sources other than 120 volt 60 hertz.
- Isolated ground receptacle not for use with single circuit base feed module.
- **Controlled receptacles are marked with a permanent symbol and the word CONTROLLED to comply with various energy code requirements including ASHRAE 90.1 and California Building Code Title 24 part 6.**
- **Circuit assignment and receptacle placement should be coordinated with a local electrician. Local electrician is responsible for circuit loading and code compliance.**
- **Consult with local authority having jurisdiction (AHJ) for requirements regarding controlled receptacles before placing orders and installation.**

To Order, Specify:

- 1) Product number.
- 2) Trim color.

TR-R	Beige
TR-AK	Chalk
TR-K	Charcoal
TR-J	Graphite
TR-G	Gray Tone
TR-NG	Orange* Isolated ground only
TR-TW	Plaster
TR-AA	Putty
TR-E	Smoke

Description	Circuit Access	Receptacle Indicator	Ground Type	Receptacle without Controlled Symbol	Price	Receptacle with Controlled Symbol	Price
3-Circuit	Circuit 1-3	N/A	Common	PRD-3-B	\$292.43	PRD-3-BC	\$299.73
	Circuit 1-3	N/A	Isolated	PRDI-5-B	318.04	PRDI-5-BC	325.99

Raceway Retrofit Kit

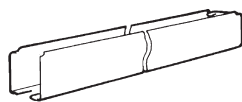

RKN-B (Non-Powered)

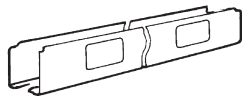

RKP-B
Class AA



Features

- Powered retrofit kit includes one power distribution assembly, powered raceway cover, and flexible power connector.
- Convert powered panels to non-powered panels or non-powered panels to powered panels.
- Non-powered retrofit includes raceway cover retainer and non-powered raceway cover (no openings).

Specification Tip

- For use with UniGroup Too and UniGroup.

To Order, Specify:

- 1) Product number.
- 2) Trim color. Not available in metallic trim colors.

Actual Height	Panel Width	Number	Trim		
			A	B	
Non-Powered					
4"(102mm)	18"(457mm)	RKN-18-B	\$254.03	\$265.10	
	24"(610mm)	RKN-2-B	258.46	273.96	
	30"(762mm)	RKN-30-B	262.89	282.82	
	36"(914mm)	RKN-3-B	267.32	291.68	
	42"(1067mm)	RKN-42-B	271.75	300.54	
48"(1219mm)	48"(1219mm)	RKN-4-B	276.18	309.40	
	54"(1372mm)	RKN-54-B	280.61	318.26	
	60"(1524mm)	RKN-5-B	285.04	327.12	
	3-Circuit				
	4"(102mm)	18"(457mm)	RKP-18-B	\$ 611.84	\$622.91
24"(610mm)		RKP-2-B	616.27	631.77	
30"(762mm)		RKP-30-B	620.70	640.63	
36"(914mm)		RKP-3-B	625.13	649.49	
42"(1067mm)		RKP-42-B	629.56	658.35	
48"(1219mm)	48"(1219mm)	RKP-4-B	633.99	667.21	
	54"(1372mm)	RKP-54-B	638.42	676.07	
	60"(1524mm)	RKP-5-B	642.85	684.93	

Electrical Components

UniGroup Too, UniGroup

Duplex Receptacle – 20 Amp

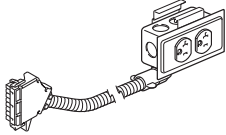

PRD-2000-M13
Class AA



Features

- Includes one duplex receptacle assembly (outlets are NEMA 5-20R configuration) with mounting hardware.
- For use with panels 36”(914mm)W and greater powered by power distribution assembly.
- Plugs into the receptacle location on the left side of the power distribution assembly.
- Receptacle and cover plate are black.

Specification Tips

- For use with UniGroup Too and UniGroup.
- Receptacle is not circuit access programmable.
- Receptacle requires new raceway covers that must be ordered separately. Field modification of non-powered raceway covers are an alternate option.
- Standard powered raceway cover receptacle outlet locations are not compatible with this product.
- Panels powered by 3-circuit power distribution assemblies manufactured prior to January 2010 must order new power distribution assemblies based on panel size through e-parts.
- **Not for use in Canada.**

To Order, Specify:

- 1) Product number.
(No finish specification required.)

Description	Circuit Access	Ground Type	Number	Price
3-Circuit – 20 Amp Duplex	Circuit 1	Common	PRD-2000-M13	\$1205.21

Raceway Cover – 20 Amp

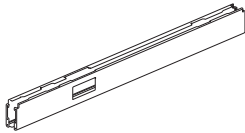

RKP-3-LS

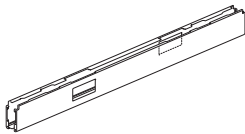

RKP-3-LB
Class AA

Features

- Includes raceway cover with receptacle openings available on one or two sides.
- For use with panels 36”(914mm)W and greater powered by 3-Circuit power distribution assemblies manufactured after January 2010.

Specification Tips

- For use with 20 Amp UniGroup Too and UniGroup duplex receptacles only.
- Blank plates are not available for unused receptacle openings.
- Power Distribution Assembly (PDA) ordered separately.

To Order, Specify:

- 1) Product number.
- 2) Trim color. Not available in metallic trim colors.

	Panel Width	Number	Trim	
			A	B
One Outlet/One Side				
	36”(914mm)	RKP-3-LS	\$ 647.23	\$ 671.59
	42”(1067mm)	RKP-42-LS	651.66	680.45
	48”(1219mm)	RKP-4-LS	656.09	689.31
	54”(1372mm)	RKP-54-LS	660.52	698.17
	60”(1524mm)	RKP-5-LS	664.95	707.03
One Outlet/Two Sides				
	36”(914mm)	RKP-3-LB	\$ 647.23	\$ 671.59
	42”(1067mm)	RKP-42-LB	651.66	680.45
	48”(1219mm)	RKP-4-LB	656.09	689.31
	54”(1372mm)	RKP-54-LB	660.52	698.17
	60”(1524mm)	RKP-5-LB	664.95	707.03

Electrical Components

UniGroup Too, UniGroup

Ported Raceway Covers

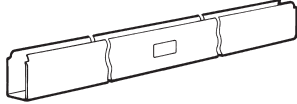

PRCN-B (Non-Powered Condition)

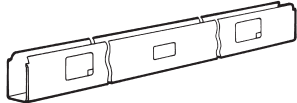

PRCP-B (Powered Condition)

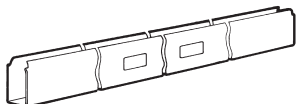

PRCN-B (Non-Powered Condition)

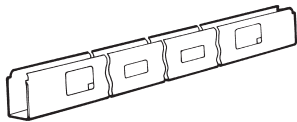

PRCP-B (Powered Condition)

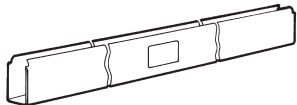

PRCN-B (Non-Powered Condition)

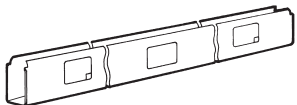

PRCP-B (Powered Condition)

Features

- Retrofit to UniGroup Too and UniGroup panel.
- Ported raceway covers enable communications equipment cabling to be routed to connector modules located on the faces of the base raceway covers. Six variations are available to accommodate the following connector modules: one modular furniture telecommunications opening centered on one side of the raceway cover; one modular furniture telecommunications opening centered on each side of the raceway cover; two modular furniture telecommunications openings on one side; two modular furniture telecommunications openings on each side; one standard wall outlet opening centered on one side; and one standard wall outlet opening centered on each side.
- Modular furniture telecommunications opening measures 1.38"(35mm)H x 2.7"(69mm)W.
- Standard wall outlet opening measures 2.25"(57mm)H x 3.75"(95mm)W.
- Openings for modular furniture telecommunications and standard wall outlets do not include covers.

Specification Tips

- Specify when no raceway cover is ordered (option -E).
- For use with UniGroup Too and UniGroup.
- For use with 3-Circuit applications.

To Order, Specify:

- 1) Product number.
- 2) Trim color. Not available in metallic trim colors.

Description	Panel Width	Non-Powered Number	Trim A	B	Powered Number	Trim A	B
One Modular Furniture Telecommunications Opening, One Side							
	18"(457mm)	PRCN-1118-B	\$ 165.98	\$ 175.23	PRCP-1118-B	\$ 165.98	\$ 175.23
	24"(610mm)	PRCN-1124-B	177.53	191.38	PRCP-1124-B	177.53	191.38
	30"(762mm)	PRCN-1130-B	189.08	207.53	PRCP-1130-B	189.08	207.53
	36"(914mm)	PRCN-1136-B	200.63	223.68	PRCP-1136-B	200.63	223.68
	42"(1067mm)	PRCN-1142-B	212.18	239.83	PRCP-1142-B	212.18	239.83
	48"(1219mm)	PRCN-1148-B	223.73	255.98	PRCP-1148-B	223.73	255.98
	54"(1372mm)	PRCN-1154-B	235.28	272.13	PRCP-1154-B	235.28	272.13
	60"(1524mm)	PRCN-1160-B	246.83	288.28	PRCP-1160-B	246.83	288.28
One Modular Furniture Telecommunications Opening, Each Side							
	18"(457mm)	PRCN-1218-B	\$ 189.05	\$ 198.30	PRCP-1218-B	\$ 189.05	\$ 198.30
	24"(610mm)	PRCN-1224-B	200.60	214.45	PRCP-1224-B	200.60	214.45
	30"(762mm)	PRCN-1230-B	212.15	230.60	PRCP-1230-B	212.15	230.60
	36"(914mm)	PRCN-1236-B	223.70	246.75	PRCP-1236-B	223.70	246.75
	42"(1067mm)	PRCN-1242-B	235.25	262.90	PRCP-1242-B	235.25	262.90
	48"(1219mm)	PRCN-1248-B	246.80	279.05	PRCP-1248-B	246.80	279.05
	54"(1372mm)	PRCN-1254-B	258.35	295.20	PRCP-1254-B	258.35	295.20
	60"(1524mm)	PRCN-1260-B	269.90	311.35	PRCP-1260-B	269.90	311.35
Two Modular Furniture Telecommunications Openings, One Side							
	30"(762mm)	PRCN-2130-B	\$ 212.15	\$ 230.60	PRCP-2130-B	\$ 212.15	\$ 230.60
	36"(914mm)	PRCN-2136-B	223.70	246.75	PRCP-2136-B	223.70	246.75
	42"(1067mm)	PRCN-2142-B	235.25	262.90	PRCP-2142-B	235.25	262.90
	48"(1219mm)	PRCN-2148-B	246.80	279.05	PRCP-2148-B	246.80	279.05
	54"(1372mm)	PRCN-2154-B	258.35	295.20	PRCP-2154-B	258.35	295.20
	60"(1524mm)	PRCN-2160-B	269.90	311.35	PRCP-2160-B	269.90	311.35
Two Modular Furniture Telecommunications Openings, Each Side							
	30"(762mm)	PRCN-2230-B	\$ 235.20	\$ 253.65	PRCP-2230-B	\$ 235.20	\$ 253.65
	36"(914mm)	PRCN-2236-B	246.75	269.80	PRCP-2236-B	246.75	269.80
	42"(1067mm)	PRCN-2242-B	258.30	285.95	PRCP-2242-B	258.30	285.95
	48"(1219mm)	PRCN-2248-B	269.85	302.10	PRCP-2248-B	269.85	302.10
	54"(1372mm)	PRCN-2254-B	281.40	318.25	PRCP-2254-B	281.40	318.25
	60"(1524mm)	PRCN-2260-B	292.95	334.40	PRCP-2260-B	292.95	334.40
One Standard Wall Outlet Opening, One Side							
	42"(1067mm)	PRCN-0142-B	\$ 212.18	\$ 239.83	PRCP-0142-B	\$ 212.18	\$ 239.83
	48"(1219mm)	PRCN-0148-B	223.73	255.98	PRCP-0148-B	223.73	255.98
	60"(1524mm)	PRCN-0160-B	246.83	288.28	PRCP-0160-B	246.83	288.28
One Standard Wall Outlet Opening, Each Side							
	42"(1067mm)	PRCN-0242-B	\$ 235.25	\$ 262.90	PRCP-0242-B	\$ 235.25	\$ 262.90
	48"(1219mm)	PRCN-0248-B	246.80	279.05	PRCP-0248-B	246.80	279.05
	60"(1524mm)	PRCN-0260-B	269.90	311.35	PRCP-0260-B	269.90	311.35

Electrical Components

UniGroup Too, UniGroup

Base Raceway End Cap



EC-10-B
Class AA

Features

- Includes ten end caps.
- For use at base raceway for end-of-run panel condition.

Note: .6 end caps included with every panel.

Order additional as necessary.

To Order, Specify:

- 1) Product number.
- 2) Trim color.

Height	Number	Trim	
		A	B
4" (102mm)	EC-10-B	\$73.76	\$83.91

Electrical and Cable Management Accessories

UniGroup Too, UniGroup

Cable Management Pole — One Channel

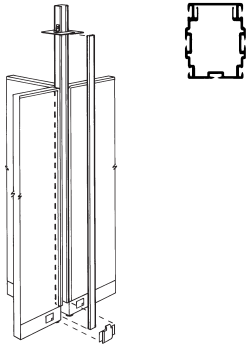

CMPF-1-BR
Class AA

Features

- Includes communications pole with cover, base raceway cover and ceiling bezel plate.
- Interface with the base raceway cover.
- Provides a means of vertically routing and accessing communications cabling within the panel's base raceway.
- May also be used to route Top Feed Harness.
- May be used in 2-way (in-line), 3-way or 4-way panel conditions.
- Attaches to panel side trim rails.
- For use up to 10'(3048mm) ceiling height.
- Refer to Specification Guide for cable management.

Specification Tips

- Cannot be used in conjunction with finish posts.
- For use with UniGroup Too and UniGroup.
- For use with 3-Circuit applications.

To Order, Specify:

- 1) Product number.
- 2) Trim color for raceway cover.
- 3) Trim color for pole.

Number	Trim	
	A	B
CMPF-1-BR	\$1058.14	\$1141.09

Cable Management Pole — Two Channels

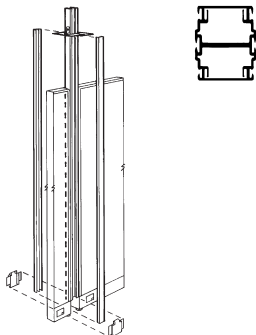

CMPT-1-B
Class AA

Features

- Includes communications pole with covers, base raceway covers and ceiling bezel plate.
- Provides cabling capacity with two integral channels.
- May also be used to route Top Feed Harness.
- May be used as a 2-way in-line panel filler.
- Interior of 2"(51mm)W pole is separated by a metal divider, which separates communication cables in each compartment.
- Attaches to panel side trim rails.
- For use up to 10'(3048mm) ceiling height.

Specification Tips

- Use straight span connector to bypass electrical distribution.
- Cannot be used in conjunction with finish posts.
- For use with UniGroup Too and UniGroup.
- For use with 3-Circuit applications.

To Order, Specify:

- 1) Product number.
- 2) Trim color for raceway cover.
- 3) Trim color for pole.

Number	Trim	
	A	B
CMPT-1-B	\$1303.98	\$1386.93

Power Breaker Marker

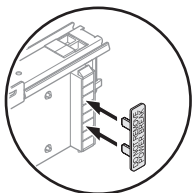

NEP-1
Class BC

Features

- Use in pairs at adjoining power distribution assemblies in the flex connector sites to prevent improper electrical connections.
- Available in standard finish color only.

Specification Tip

- For use with UniGroup Too and UniGroup.

To Order, Specify:

- 1) Product number.
(No finish specification required.)

Quantity	Number	Price
Fifty(50)	NEP-1	\$292.32

Electrical and Cable Management Accessories

UniGroup

Expanded Top Cap Raceway

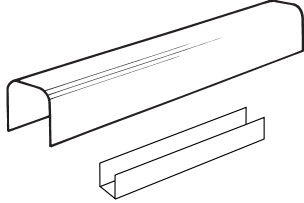

ETCR
Class AA

Features

- Includes channel and top cap.
- Refer to specification guide for cable management.
- Replaces the panel's top cap and adds 2"(51mm) to the panel's height.
- For use with 3-Circuit applications.

Specification Tip

- For use with UniGroup.

To Order, Specify:

- 1) Product number.
- 2) Trim color.

Width	Number	Price
12"(305mm)	ETCR-12	\$ 423.34
18"(457mm)	ETCR-18	456.90
24"(610mm)	ETCR-24	490.46
30"(762mm)	ETCR-30	524.02
36"(914mm)	ETCR-36	557.58
42"(1067mm)	ETCR-42	591.14
48"(1219mm)	ETCR-48	624.70
60"(1524mm)	ETCR-60	691.82

Expanded Top Finish Cap

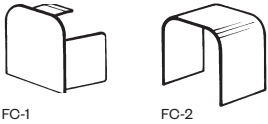

FC-1

FC-2

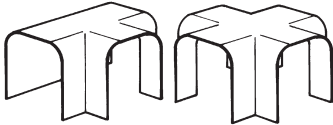

FC-3

FC-4

Features

- Includes cover.
- Used to join expanded top caps in a panel run.
- Two-way cap is for straight connection over a straight finish post.
- Three-way cap is for connections of three panels.
- Four-way cap is for connections of four panels.
- 90° corner cap is for use in conjunction with a 90° finish post.
- End-of-run cap is used at an end-of-panel-run condition.
- For use with 3-Circuit applications.

Specification Tip

- For use with UniGroup.

To Order, Specify:

- 1) Product number.
- 2) Trim color.

Description	Number	Price
End-of-Run Cap	FC-1	\$ 115.26
Two-Way	FC-2	97.46
Three-Way	FC-3	157.39
Four-Way	FC-4	241.61

Power Distribution for Hardwire Applications

UniGroup Too, UniGroup

Infeeds

Infeeds	Applications
1 Base Feed	48" (1219mm) or as required
2 Top Feed	Ceiling Height (H) + 18" (457mm)

Panel Applications

Panel Applications	Panel Applications
3 Between two junction boxes on one panel	Panel Width (W) - 17" (432mm)
4 Between junction boxes if one per panel	Panel Width (W) - 8" (203mm)
5 Across panel-panel connection	9" (229mm)
6 Across 3- or 4-Way connection	11" (279mm)

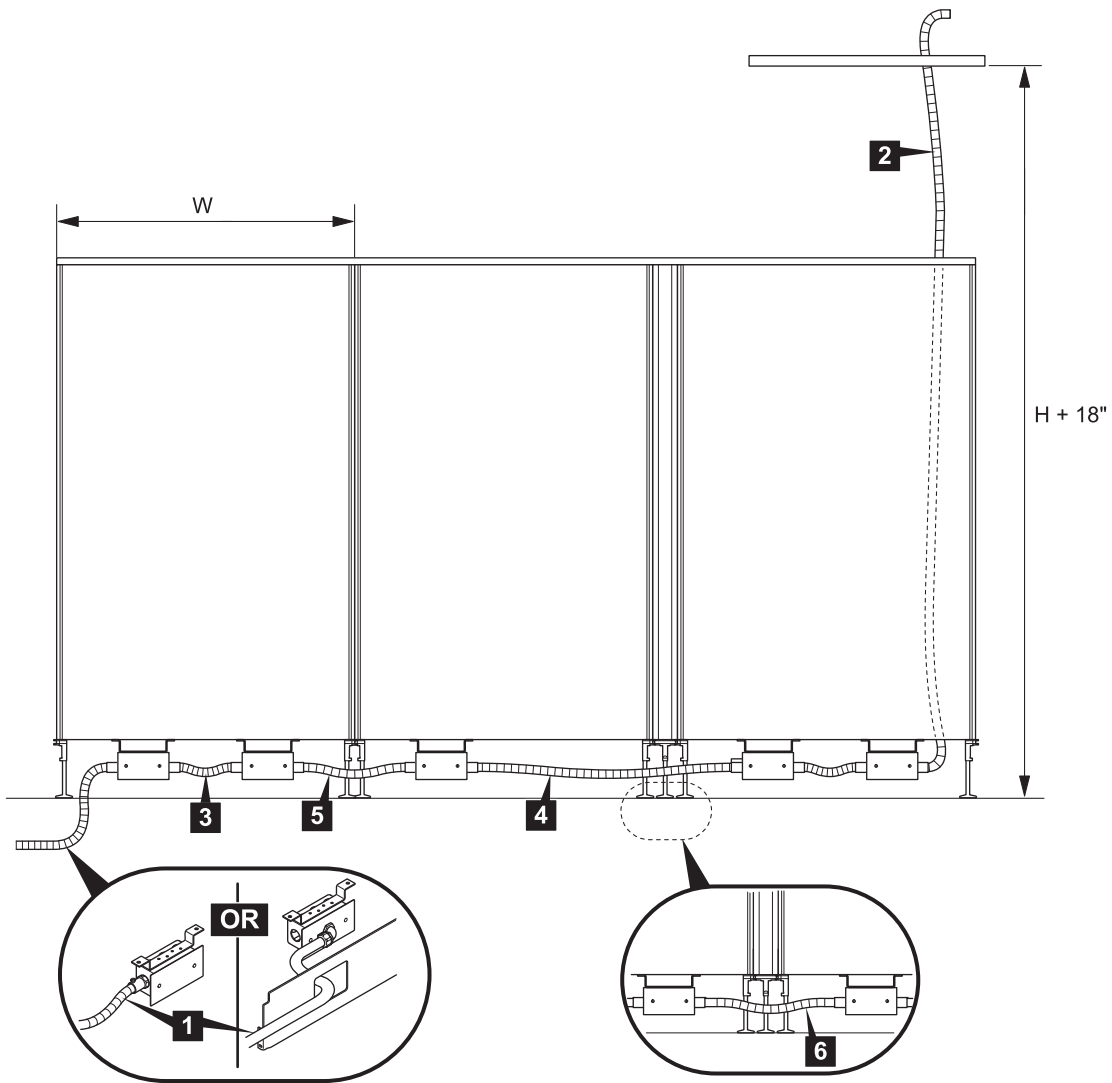

Electrical Components — Hardwire

UniGroup Too, UniGroup

Base Feed Kit

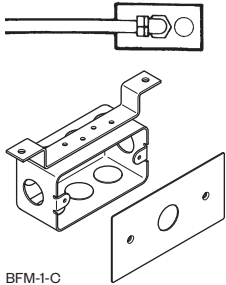

BFM-1-C
Class AA



Features

- Includes one electrical box with 0.5"(13mm) knockouts, one base feed cover plate and panel mounting hardware.
- For panel hardwire infeed connections to floor, column or wall.

Specification Tips

- For use with UniGroup Too and UniGroup.
- **Conduit, fittings, and receptacle are field supplied.**

To Order, Specify:

- 1) Product number.
- 2) Trim color (standard only).

Number	Price
BFM-1-C	\$279.42

Dual Power Access Raceway Kit — 4"-High Base Raceway

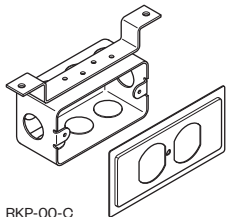

RKP-00-C
Class AA



Features

- Includes one electrical box with 0.5"(13mm) knockouts, one base feed cover plate, receptacle cover plate and panel mounting hardware.
- For hardwire receptacle access in panels.

Specification Tips

- Powered raceway cover ordered separately.
- Raceway cover requires field modification.
- For use with UniGroup Too and UniGroup.
- **Conduit, fittings, and receptacle are field supplied.**

To Order, Specify:

- 1) Product number.
- 2) Trim color (standard only).

Height	Number	Price
4"(102mm)	RKP-00-C	\$525.46

Blank Cover Plate

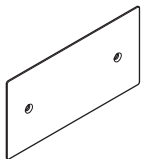

BPM-1-C
Class AA

Features

- Includes one blank plate and hardware.
- For hardwire electrical box applications where no power access is required.

To Order, Specify:

- 1) Product number.
- 2) Trim color (standard only).

Number	Price
BPM-1-C	\$81.04

Raceway Covers

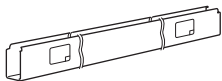

PRCP
Class AA

Features

- Includes one raceway cover with openings for power.
- Retrofit to UniGroup Too and UniGroup panel.

Specification Tips

- Specify when no raceway cover is ordered (option -E).
- For use with UniGroup Too and UniGroup.
- Opening of raceway cover needs to be field modified for hardwire applications. See installation instructions.

To Order, Specify:

- 1) Product number.
- 2) Trim color.

Width	Number	Trim	
		A	B
18"(457mm)	PRCP-0018-B	\$ 173.68	\$ 178.29
24"(610mm)	PRCP-0024-B	189.90	196.77
30"(762mm)	PRCP-0030-B	206.12	215.25
36"(914mm)	PRCP-0036-B	222.34	233.73
42"(1067mm)	PRCP-0042-B	238.56	252.21
48"(1219mm)	PRCP-0048-B	254.78	270.69
54"(1372mm)	PRCP-0054-B	271.00	289.17
60"(1524mm)	PRCP-0060-B	287.22	307.65

Electrical Components — Hardwire / International

UniGroup Too, UniGroup

Top Feed Module – Hardwire / International – UniGroup Too Only

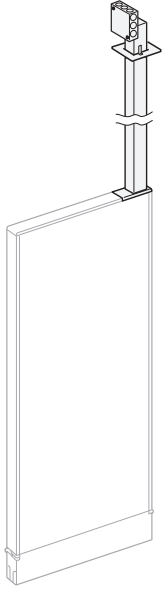

E2FM-NT
Class AC

Features

- Includes electrical box, ceiling bezel plate, single channel pole, hardware and square painted top cover.
- For connection to the electrical source located in space above a drop ceiling.
- For use with Chicago/Hardwire applications and with 4 meter Power Logic cord, ordered separately from Power Logic.
- For routing and cabling capacities, see Specification Guide.
- Removable cover on pole provides access to pathway.
- Routes power to base raceway.

Specification Tips

- For installation on panels no less the 18"(457mm)W.
- Not for use with glazed add-on panels, glazed panels or single doors.
- For use with UniGroup Too square painted top cap panels only, field cutting of top cap is required.
- Application may require approval of local authority having jurisdiction (AHJ); ensure compliance before placing orders and installation.

To Order, Specify:

- 1) Product number.
- 2) Trim color for pole.
- 3) Trim color for top cap piece.

Panel Height	Pole Length	Number	Trim	
			A	B
32"(813mm) - 56"(1422mm)	124"(3150mm)	E2FM-3200-NT	\$685.09	\$ 751.39
64"(1626mm) - 80"(2032mm)	70"(1778mm)	E2FM-6400-NT	633.00	663.03

Top Feed Module – Hardwire / International – UniGroup Only

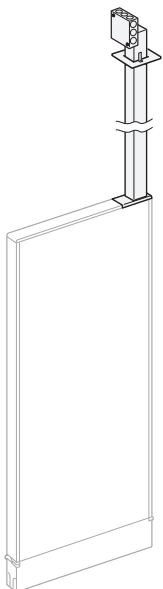

TFM-NT
Class AA

Features

- Includes electrical box, ceiling bezel plate, single channel pole, hardware and square painted top cover.
- For connection to the electrical source located in space above a drop ceiling.
- For use with Chicago/Hardwire applications and with 4 meter Power Logic cord, ordered separately from Power Logic.
- For routing and cabling capacities, see Specification Guide.
- Removable cover on pole provides access to pathway.
- Routes power to base raceway.

Specification Tips

- For installation on panels no less the 18"(457mm) wide.
- Not for use with glazed add-on panels, glazed panels or single doors.
- For use with UniGroup radius steel top cap, field cutting of top cap is required. When used with UniGroup radius wood top cap, access hole must be cut into top cap.
- Application may require approval of local authority having jurisdiction (AHJ); ensure compliance before placing orders and installation.

To Order, Specify:

- 1) Product number.
- 2) Trim color for pole.
- 3) Trim color for top cap piece.

Panel Height	Pole Length	Number	Price
32"(813mm) - 56"(1422mm)	124"(3150mm)	TFM-3000-NT	\$700.04
64"(1626mm) - 82"(2083mm)	70"(1778mm)	TFM-6400-NT	676.56

Electrical Components — International

UniGroup Too, UniGroup

International Power Components

For power applications outside North America we recommend the use of **Power Logic** soft wiring components. Power Logic offers a system of single circuit power cords and receptacle modules that fit into our non-powered base raceway. Receptacle modules are offered with two sockets (3 and 4 socket versions also available). Each receptacle module has sockets, switches and fuses that are appropriate for each country around the world. Contact the Power Logic regional sales office in your area to help with planning details to assure local electrical code compliance. Contact Power Logic via the Haworth/Power Logic website, (www.haworth.com/powerlogic), or through their corporate offices in Cape Town, South Africa at 27-21-704-1450. Power Logic also offers power solutions for desktop, conference table or freestanding power applications.



Power Entry Cord

Class AC - GSA: Open Market

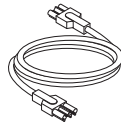

Cord

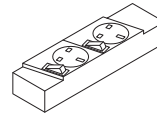

Receptacle



Splitter

Plastic Liner

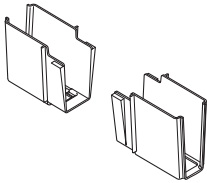

HCT-0000
Class BA

Features

- Includes a package of 10 plastic liners (enough for 5 panels).
- Used when routing communication cables in the top trough of PLACES.
- Two liners per panel regardless of panel width.

To Order, Specify:

- 1) Product number.
(No finish specification required.)

Number	Price
HCT-0000	\$97.99

Adaptable Worksurfaces — Rectangular

General Specifications



WURA
Rectangular



WURT-N43
WURT-N34
Rectangular Transition



WURS
Rectangular Swell



WURW
Rectangular Inverse Swell

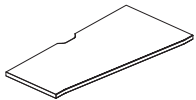

WURE-N34
WURE-N43
Wedge

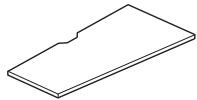

WURG-N34
WURG-N43
Sharp Wedge



WURR
Rectangular Radius End

Common Features

- Includes worksurface and tie plate.
- Available in high-pressure laminate (HPL) or wood veneer.
- Laminate edge option:
 - (J) 3mm edgeband on user side with 1mm edgeband on sides and back.
 - (F) Knife edge on user side and 1mm edgeband on sides and back. Knife edge profile receives a clear coat finish.
- Wood veneer edge option:
 - (K) 3mm edgeband on user side with 1mm edgeband on sides and back.
 - (U) Knife edge on user side and 1mm edgeband on sides and back. Knife edge profile receives a clear coat finish.
- Worksurfaces predrilled to accept most support options. 36"(914mm)W and above are predrilled for pedestals.
- Optional wireway:
 - 24"(610mm)W-60"(1524mm)W worksurfaces have one wireway centered on back edge.
 - Worksurfaces wider than 60"(1524mm) have two wireways on back edge.
 - Wireway will be color-matched to solid side/back edge trim. Wood veneer or patterned/wood grain laminate will have a Charcoal wireway.
 - Refer to Specification Guide for wireway details.
- Optional Belong Hatch cutout:
 - Laminate tops only with one cutout.
 - Available on worksurfaces 30"(762mm)D and widths 42"(1067mm), 48"(1219mm), 51"(1295mm), 54"(1372mm) and 60"(1524mm).
 - Requires separately specified Belong Hatch.
 - Refer to Specification Guide for cutout details.
- **Installed worksurfaces without wireway will not allow clearance for power plug.**
- Depths and widths shown in nominal dimensions.

Specification Tips

- **Worksurface support specific to product line and worksurface edge guidelines; must be separately specified.**
- Knife edge requires use of worksurface supports for that application; worksurface support panel and/or side bracket for use with knife edge.
- Intermediate support is required for unsupported worksurface span greater than 60"(1524mm).
- Not intended for use on Height Adjustable Tables.

Note: Separately specified worksurface reinforcement bar provides additional support for worksurfaces with 60"(1524mm) spans that are heavily loaded and not otherwise supported by mid-span cantilevers, worksurface support panels, columns, legs or attached lower storage.

Adaptable Worksurfaces — Rectangular

Rectangular

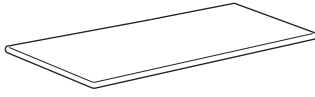

WURA
Class CA

To Order, Specify:

1) Product number, including:

1 Surface Option:

- L** Laminate
- W** Wood

2 Edge Option:

Laminate:

- J** Edgeband
- F** Knife

Wood:

- K** Edgeband
- U** Knife

3 Wireway/Cutout Option:

- A** Notched
- C** Without
- H** Belong Hatch

2) Laminate color or Wood finish color.

3) Edge trim color (laminite only).

Depth	Width	Number 1 2 3	HPL Edgeband (J)			HPL Knife Edge (F)			Wood Edgeband (K)		Wood Knife Edge (U)	
			A	B	E	A	B	E	A	B	A	B
18"(457mm)	24"(610mm)	WURA-1824- S	\$ 430.52	\$ 495.32	\$ 858.20	\$ 760.52	\$ 825.32	\$ 1188.20	\$ 707.00	\$ 732.92	\$ 1079.00	\$ 1104.92
	26"(660mm)	WURA-1826- S	443.48	513.68	906.80	793.48	863.68	1256.80	743.00	771.08	1137.00	1165.08
	30"(762mm)	WURA-1830- S	469.40	550.40	1004.00	859.40	940.40	1394.00	815.00	847.40	1253.00	1285.40
	32"(813mm)	WURA-1832- S	482.36	568.76	1052.60	892.36	978.76	1462.60	851.00	885.56	1311.00	1345.56
	36"(914mm)	WURA-1836- S	508.28	605.48	1149.80	958.28	1055.48	1599.80	923.00	961.88	1427.00	1465.88
	38"(965mm)	WURA-1838- S	521.24	623.84	1198.40	991.24	1093.84	1668.40	959.00	1000.04	1485.00	1526.04
	42"(1067mm)	WURA-1842- S	547.16	660.56	1295.60	1057.16	1170.56	1805.60	1031.00	1076.36	1601.00	1646.36
	44"(1118mm)	WURA-1844- S	565.12	683.92	1349.20	1095.12	1213.92	1879.20	1072.00	1119.52	1664.00	1711.52
	48"(1219mm)	WURA-1848- S	601.04	730.64	1456.40	1171.04	1300.64	2026.40	1154.00	1205.84	1790.00	1841.84
	50"(1270mm)	WURA-1850- S	619.00	754.00	1510.00	1209.00	1344.00	2100.00	1195.00	1249.00	1853.00	1907.00
	54"(1372mm)	WURA-1854- S	654.92	800.72	1617.20	1284.92	1430.72	2247.20	1277.00	1335.32	1979.00	2037.32
	56"(1422mm)	WURA-1856- S	672.88	824.08	1670.80	1322.88	1474.08	2320.80	1318.00	1378.48	2042.00	2102.48
	60"(1524mm)	WURA-1860- S	708.80	870.80	1778.00	1308.80	1470.80	2378.00	1400.00	1464.80	2060.00	2124.80
	62"(1575mm)	WURA-1862- S	726.76	894.16	1831.60	1346.76	1514.16	2451.60	1441.00	1507.96	2123.00	2189.96
	66"(1676mm)	WURA-1866- S	762.68	940.88	1938.80	1422.68	1600.88	2598.80	1523.00	1594.28	2249.00	2320.28
	68"(1727mm)	WURA-1868- S	780.64	964.24	1992.40	1460.64	1644.24	2672.40	1564.00	1637.44	2312.00	2385.44
	72"(1829mm)	WURA-1872- S	816.56	1010.96	2099.60	1536.56	1730.96	2819.60	1646.00	1723.76	2438.00	2515.76
	74"(1880mm)	WURA-1874- S	834.52	1034.32	2153.20	1574.52	1774.32	2893.20	1687.00	1766.92	2501.00	2580.92
	78"(1981mm)	WURA-1878- S	870.44	1081.04	2260.40	1650.44	1861.04	3040.40	1769.00	1853.24	2627.00	2711.24
	80"(2032mm)	WURA-1880- S	888.40	1104.40	2314.00	1688.40	1904.40	3114.00	1810.00	1896.40	2690.00	2776.40
	84"(2134mm)	WURA-1884- S	924.32	1151.12	2421.20	1764.32	1991.12	3261.20	1892.00	1982.72	2816.00	2906.72
	86"(2184mm)	WURA-1886- S	942.28	1174.48	2474.80	1802.28	2034.48	3334.80	1933.00	2025.88	2879.00	2971.88
	90"(2286mm)	WURA-1890- S	978.20	1221.20	2582.00	1878.20	2121.20	3482.00	2015.00	2112.20	3005.00	3102.20
	92"(2337mm)	WURA-1892- S	996.16	1244.56	2635.60	1916.16	2164.56	3555.60	2056.00	2155.36	3068.00	3167.36
	96"(2438mm)	WURA-1896- S	1032.08	1291.28	2742.80	1992.08	2251.28	3702.80	2138.00	2241.68	3194.00	3297.68
	98"(2489mm)	WURA-1898- S	1050.04	1314.64	2796.40	2030.04	2294.64	3776.40	2179.00	2284.84	3257.00	3362.84
	102"(2591mm)	WURA-18A2- S	1085.96	1361.36	2903.60	2105.96	2381.36	3923.60	2261.00	2371.16	3383.00	3493.16
	104"(2642mm)	WURA-18A4- S	1103.92	1384.72	2957.20	2143.92	2424.72	3997.20	2302.00	2414.32	3446.00	3558.32
	108"(2743mm)	WURA-18A8- S	1139.84	1431.44	3064.40	2219.84	2511.44	4144.40	2384.00	2500.64	3572.00	3688.64
	110"(2794mm)	WURA-18B0- S	1157.80	1454.80	3118.00	2257.80	2554.80	4218.00	2425.00	2543.80	3635.00	3753.80
	114"(2896mm)	WURA-18B4- S	1193.72	1501.52	3225.20	2333.72	2641.52	4365.20	2507.00	2630.12	3761.00	3884.12
	116"(2946mm)	WURA-18B6- S	1211.68	1524.88	3278.80	2371.68	2684.88	4438.80	2548.00	2673.28	3824.00	3949.28
	120"(3048mm)	WURA-18C0- S	1247.60	1571.60	3386.00	2447.60	2771.60	4586.00	2630.00	2759.60	3950.00	4079.60

Adaptable Worksurfaces — Rectangular

Rectangular

Depth	Width	Number ①②③	HPL Edgeband (J)			HPL Knife Edge (F)			Wood Edgeband (K)		Wood Knife Edge (U)		
			A	B	E	A	B	E	A	B	A	B	
24"(610mm)	24"(610mm)	WURA-2424-	S	\$ 482.36	\$ 568.76	\$ 1052.60	\$ 842.36	\$ 928.76	\$ 1412.60	\$ 851.00	\$ 885.56	\$ 1259.00	\$ 1293.56
	26"(660mm)	WURA-2426-	S	499.64	593.24	1117.40	879.64	973.24	1497.40	899.00	936.44	1329.00	1366.44
	30"(762mm)	WURA-2430-	S	534.20	642.20	1247.00	954.20	1062.20	1667.00	995.00	1038.20	1469.00	1512.20
	32"(813mm)	WURA-2432-	S	551.48	666.68	1311.80	991.48	1106.68	1751.80	1043.00	1089.08	1539.00	1585.08
	36"(914mm)	WURA-2436-	S	586.04	715.64	1441.40	1066.04	1195.64	1921.40	1139.00	1190.84	1679.00	1730.84
	38"(965mm)	WURA-2438-	S	603.32	740.12	1506.20	1103.32	1240.12	2006.20	1187.00	1241.72	1749.00	1803.72
	42"(1067mm)	WURA-2442-	S	637.88	789.08	1635.80	1177.88	1329.08	2175.80	1283.00	1343.48	1889.00	1949.48
	44"(1118mm)	WURA-2444-	S	655.16	813.56	1700.60	1215.16	1373.56	2260.60	1331.00	1394.36	1959.00	2022.36
	48"(1219mm)	WURA-2448-	S	689.72	862.52	1830.20	1289.72	1462.52	2430.20	1427.00	1496.12	2099.00	2168.12
	50"(1270mm)	WURA-2450-	S	707.00	887.00	1895.00	1327.00	1507.00	2515.00	1475.00	1547.00	2169.00	2241.00
	54"(1372mm)	WURA-2454-	S	741.56	935.96	2024.60	1401.56	1595.96	2684.60	1571.00	1648.76	2309.00	2386.76
	56"(1422mm)	WURA-2456-	S	758.84	960.44	2089.40	1438.84	1640.44	2769.40	1619.00	1699.64	2379.00	2459.64
	60"(1524mm)	WURA-2460-	S	793.40	1009.40	2219.00	1393.40	1609.40	2819.00	1715.00	1801.40	2375.00	2461.40
	62"(1575mm)	WURA-2462-	S	810.68	1033.88	2283.80	1430.68	1653.88	2903.80	1763.00	1852.28	2445.00	2534.28
	66"(1676mm)	WURA-2466-	S	845.24	1082.84	2413.40	1505.24	1742.84	3073.40	1859.00	1954.04	2585.00	2680.04
	68"(1727mm)	WURA-2468-	S	862.52	1107.32	2478.20	1542.52	1787.32	3158.20	1907.00	2004.92	2655.00	2752.92
	72"(1829mm)	WURA-2472-	S	897.08	1156.28	2607.80	1617.08	1876.28	3327.80	2003.00	2106.68	2795.00	2898.68
	74"(1880mm)	WURA-2474-	S	914.36	1180.76	2672.60	1654.36	1920.76	3412.60	2051.00	2157.56	2865.00	2971.56
	78"(1981mm)	WURA-2478-	S	948.92	1229.72	2802.20	1728.92	2009.72	3582.20	2147.00	2259.32	3005.00	3117.32
	80"(2032mm)	WURA-2480-	S	966.20	1254.20	2867.00	1766.20	2054.20	3667.00	2195.00	2310.20	3075.00	3190.20
	84"(2134mm)	WURA-2484-	S	1000.76	1303.16	2996.60	1840.76	2143.16	3836.60	2291.00	2411.96	3215.00	3335.96
	86"(2184mm)	WURA-2486-	S	1018.04	1327.64	3061.40	1878.04	2187.64	3921.40	2339.00	2462.84	3285.00	3408.84
	90"(2286mm)	WURA-2490-	S	1052.60	1376.60	3191.00	1952.60	2276.60	4091.00	2435.00	2564.60	3425.00	3554.60
	92"(2337mm)	WURA-2492-	S	1069.88	1401.08	3255.80	1989.88	2321.08	4175.80	2483.00	2615.48	3495.00	3627.48
96"(2438mm)	WURA-2496-	S	1104.44	1450.04	3385.40	2064.44	2410.04	4345.40	2579.00	2717.24	3635.00	3773.24	
98"(2489mm)	WURA-2498-	S	1121.72	1474.52	3450.20	2101.72	2454.52	4430.20	2627.00	2768.12	3705.00	3846.12	
102"(2591mm)	WURA-24A2-	S	1156.28	1523.48	3579.80	2176.28	2543.48	4599.80	2723.00	2869.88	3845.00	3991.88	
104"(2642mm)	WURA-24A4-	S	1173.56	1547.96	3644.60	2213.56	2587.96	4684.60	2771.00	2929.76	3915.00	4064.76	
108"(2743mm)	WURA-24A8-	S	1208.12	1596.92	3774.20	2288.12	2676.92	4854.20	2867.00	3022.52	4055.00	4210.52	
110"(2794mm)	WURA-24B0-	S	1225.40	1621.40	3839.00	2325.40	2721.40	4939.00	2915.00	3073.40	4125.00	4283.40	
114"(2896mm)	WURA-24B4-	S	1259.96	1670.36	3968.60	2399.96	2810.36	5108.60	3011.00	3175.16	4265.00	4429.16	
116"(2946mm)	WURA-24B6-	S	1277.24	1694.84	4033.40	2437.24	2854.84	5193.40	3059.00	3226.04	4335.00	4502.04	
120"(3048mm)	WURA-24C0-	S	1311.80	1743.80	4163.00	2511.80	2943.80	5363.00	3155.00	3327.80	4475.00	4647.80	
30"(762mm)	24"(610mm)	WURA-3024-	S	\$ 534.20	\$ 642.20	\$ 1247.00	\$ 924.20	\$ 1032.20	\$ 1637.00	\$ 995.00	\$ 1038.20	\$ 1439.00	\$ 1482.20
	26"(660mm)	WURA-3026-	S	555.80	672.80	1328.00	965.80	1082.80	1738.00	1055.00	1101.80	1521.00	1567.80
	30"(762mm)	WURA-3030-	S	599.00	734.00	1490.00	1049.00	1184.00	1940.00	1175.00	1229.00	1685.00	1739.00
	32"(813mm)	WURA-3032-	S	620.60	764.60	1571.00	1090.60	1234.60	2041.00	1235.00	1292.60	1767.00	1824.60
	36"(914mm)	WURA-3036-	S	663.80	825.80	1733.00	1173.80	1335.80	2243.00	1355.00	1419.80	1931.00	1995.80
	38"(965mm)	WURA-3038-	S	685.40	856.40	1814.00	1215.40	1386.40	2344.00	1415.00	1483.40	2013.00	2081.40
	42"(1067mm)	WURA-3042-	S	728.60	917.60	1976.00	1298.60	1487.60	2546.00	1535.00	1610.60	2177.00	2252.60
	44"(1118mm)	WURA-3044-	S	750.20	948.20	2057.00	1340.20	1538.20	2647.00	1595.00	1674.20	2259.00	2338.20
	48"(1219mm)	WURA-3048-	S	793.40	1009.40	2219.00	1423.40	1639.40	2849.00	1715.00	1801.40	2423.00	2509.40
	50"(1270mm)	WURA-3050-	S	815.00	1040.00	2300.00	1465.00	1690.00	2950.00	1775.00	1865.00	2505.00	2595.00
	54"(1372mm)	WURA-3054-	S	858.20	1101.20	2462.00	1548.20	1791.20	3152.00	1895.00	1992.20	2669.00	2766.20
	56"(1422mm)	WURA-3056-	S	879.80	1131.80	2543.00	1589.80	1841.80	3253.00	1955.00	2055.80	2751.00	2851.80
	60"(1524mm)	WURA-3060-	S	923.00	1193.00	2705.00	1623.00	1793.00	3305.00	2075.00	2183.00	2735.00	2843.00
	62"(1575mm)	WURA-3062-	S	944.60	1223.60	2786.00	1664.60	1843.60	3406.00	2135.00	2246.60	2817.00	2928.60
	66"(1676mm)	WURA-3066-	S	987.80	1284.80	2948.00	1647.80	1944.80	3608.00	2255.00	2373.80	2981.00	3099.80
	68"(1727mm)	WURA-3068-	S	1009.40	1315.40	3029.00	1689.40	1995.40	3709.00	2315.00	2437.40	3063.00	3185.40
	72"(1829mm)	WURA-3072-	S	1052.60	1376.60	3191.00	1772.60	2096.60	3911.00	2435.00	2564.60	3227.00	3356.60
	74"(1880mm)	WURA-3074-	S	1074.20	1407.20	3272.00	1814.20	2147.20	4012.00	2495.00	2628.20	3309.00	3442.20
	78"(1981mm)	WURA-3078-	S	1117.40	1468.40	3434.00	1897.40	2248.40	4214.00	2615.00	2755.40	3473.00	3613.40
	80"(2032mm)	WURA-3080-	S	1139.00	1499.00	3515.00	1939.00	2299.00	4315.00	2675.00	2819.00	3555.00	3699.00
	84"(2134mm)	WURA-3084-	S	1182.20	1560.20	3677.00	2022.20	2400.20	4517.00	2795.00	2946.20	3719.00	3870.20
	86"(2184mm)	WURA-3086-	S	1203.80	1590.80	3758.00	2063.80	2450.80	4618.00	2855.00	3009.80	3801.00	3955.80
	90"(2286mm)	WURA-3090-	S	1247.00	1652.00	3920.00	2147.00	2552.00	4820.00	2975.00	3137.00	3965.00	4127.00
	92"(2337mm)	WURA-3092-	S	1268.60	1682.60	4001.00	2188.60	2602.60	4921.00	3035.00	3200.60	4047.00	4212.60
96"(2438mm)	WURA-3096-	S	1311.80	1743.80	4163.00	2271.80	2703.80	5123.00	3155.00	3327.80	4211.00	4383.80	
98"(2489mm)	WURA-3098-	S	1333.40	1774.40	4244.00	2313.40	2754.40	5224.00	3215.00	3391.40	4293.00	4469.40	
102"(2591mm)	WURA-30A2-	S	1376.60	1835.60	4406.00	2396.60	2855.60	5426.00	3335.00	3518.60	4457.00	4640.60	
104"(2642mm)	WURA-30A4-	S	1398.20	1866.20	4487.00	2438.20	2906.20	5527.00	3395.00	3582.20	4539.00	4726.20	
108"(2743mm)	WURA-30A8-	S	1441.40	1927.40	4649.00	2521.40	3007.40	5729.00	3515.00	3709.40	4703.00	4897.40	
110"(2794mm)	WURA-30B0-	S	1463.00	1958.00	4730.00	2563.00	3058.00	5830.00	3575.00	3773.00	4785.00	4983.00	
114"(2896mm)	WURA-30B4-	S	1506.20	2019.20	4892.00	2646.20	3159.20	6032.00	3695.00	3900.20	4949.00	5154.20	
116"(2946mm)	WURA-30B6-	S	1527.80	2049.80	4973.00	2687.80	3209.80	6133.00	3755.00	3963.80	5031.00	5239.80	
120"(3048mm)	WURA-30C0-	S	1571.00	2111.00	5135.00	2771.00	3311.00	6335.00	3875.00	4091.00	5195.00	5411.00	

Adaptable Worksurfaces — Rectangular

Rectangular Transition

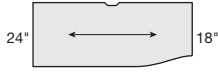

WURT-N43



WURT-N34

Class CA

Unique Specifications

- Worksurface less than 42"(1067mm)W suggested pedestal style is mobile.
- Worksurfaces greater than 42"(1067mm)W attached pedestal may be installed on deepest side.

To Order, Specify:

1) Product number, including:

1 Surface Option:

- L** Laminate
- W** Wood

2 Edge Option:

Laminate:

- J** Edgeband
- F** Knife

Wood:

- K** Edgeband
- U** Knife

3 Wireway Option:

- A** Notched
- C** Without

2) Laminate color or Wood finish color.

3) Edge trim color (laminite only).

Left/Right Depth	Width	Number 1 2 3	HPL Edgeband (J)			HPL Knife Edge (F)			Wood Edgeband (K)		Wood Knife Edge (U)			
			A	B	E	A	B	E	A	B	A	B		
24"(610mm)/18"(457mm)	24"(610mm)	WURT-2424-	S	N43	\$525.68	\$564.16	\$684.52	\$813.52	\$852.00	\$972.36	\$1187.59	\$1245.38	\$1594.25	\$1652.04
	30"(762mm)	WURT-2430-	S	N43	592.88	635.98	772.06	901.60	944.70	1080.78	1326.37	1391.18	1770.11	1834.92
	36"(914mm)	WURT-2436-	S	N43	660.08	707.80	859.60	989.68	1037.40	1189.20	1465.15	1536.98	1945.97	2017.80
	42"(1067mm)	WURT-2442-	S	N43	727.28	779.62	947.14	1077.76	1130.10	1297.62	1603.93	1682.78	2121.83	2200.68
	48"(1219mm)	WURT-2448-	S	N43	794.48	851.44	1034.68	1165.84	1222.80	1406.04	1742.71	1828.58	2297.69	2383.56
	54"(1372mm)	WURT-2454-	S	N43	861.68	923.26	1122.22	1253.92	1315.50	1514.46	1881.49	1974.38	2473.55	2566.44
24"(610mm)/30"(762mm)	24"(610mm)	WURT-3024-	S	N45	\$564.16	\$602.64	\$723.00	\$852.00	\$890.48	\$1010.84	\$1226.07	\$1283.86	\$1632.73	\$1690.52
	30"(762mm)	WURT-3030-	S	N45	631.36	674.46	810.54	940.08	983.18	1119.26	1364.85	1429.66	1808.59	1873.40
	36"(914mm)	WURT-3036-	S	N45	698.56	746.28	898.08	1028.16	1075.88	1227.68	1503.63	1575.46	1984.45	2056.28
	42"(1067mm)	WURT-3042-	S	N45	765.76	818.10	985.62	1116.24	1168.58	1336.10	1642.41	1721.26	2160.31	2239.16
	48"(1219mm)	WURT-3048-	S	N45	832.96	889.92	1073.16	1204.32	1261.28	1444.52	1781.19	1867.06	2336.17	2422.04
	54"(1372mm)	WURT-3054-	S	N45	900.16	961.74	1160.70	1292.40	1353.98	1552.94	1919.97	2012.86	2512.03	2604.92
30"(762mm)/24"(610mm)	24"(610mm)	WURT-3024-	S	N54	\$564.16	\$602.64	\$723.00	\$852.00	\$890.48	\$1010.84	\$1226.07	\$1283.86	\$1632.73	\$1690.52
	30"(762mm)	WURT-3030-	S	N54	631.36	674.46	810.54	940.08	983.18	1119.26	1364.85	1429.66	1808.59	1873.40
	36"(914mm)	WURT-3036-	S	N54	698.56	746.28	898.08	1028.16	1075.88	1227.68	1503.63	1575.46	1984.45	2056.28
	42"(1067mm)	WURT-3042-	S	N54	765.76	818.10	985.62	1116.24	1168.58	1336.10	1642.41	1721.26	2160.31	2239.16
	48"(1219mm)	WURT-3048-	S	N54	832.96	889.92	1073.16	1204.32	1261.28	1444.52	1781.19	1867.06	2336.17	2422.04
	54"(1372mm)	WURT-3054-	S	N54	900.16	961.74	1160.70	1292.40	1353.98	1552.94	1919.97	2012.86	2512.03	2604.92
30"(762mm)/24"(610mm)	24"(610mm)	WURT-3060-	S	N54	967.36	1033.56	1248.24	1380.48	1446.68	1661.36	2058.75	2158.66	2687.89	2787.80
	30"(762mm)	WURT-3060-	S	N54	967.36	1033.56	1248.24	1380.48	1446.68	1661.36	2058.75	2158.66	2687.89	2787.80
	36"(914mm)	WURT-3060-	S	N54	967.36	1033.56	1248.24	1380.48	1446.68	1661.36	2058.75	2158.66	2687.89	2787.80
	42"(1067mm)	WURT-3060-	S	N54	967.36	1033.56	1248.24	1380.48	1446.68	1661.36	2058.75	2158.66	2687.89	2787.80
	48"(1219mm)	WURT-3060-	S	N54	967.36	1033.56	1248.24	1380.48	1446.68	1661.36	2058.75	2158.66	2687.89	2787.80
	54"(1372mm)	WURT-3060-	S	N54	967.36	1033.56	1248.24	1380.48	1446.68	1661.36	2058.75	2158.66	2687.89	2787.80

Adaptable Worksurfaces — Rectangular

Swell/Inverse Swell

Swell

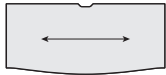

WURS

Inverse Swell

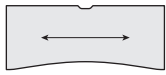

WURW
Class CA

Unique Specifications

- Suggested pedestal style is mobile.
- Belong Hatch cutout only available on Swell work surface.

To Order, Specify:

1) Product number, including:

1 Surface Option:

- L** Laminate
- W** Wood

2 Edge Option:

- Laminate:
- J** Edgeband
 - F** Knife

- Wood:
- K** Edgeband
 - U** Knife

3 Wireway/Cutout Option:

- A** Notched
- C** Without
- H** Belong Hatch

2) Laminate color or Wood finish color.

3) Edge trim color (laminite only).

Depth	Swell Depth	Width	Number	1	2	3	HPL Edgeband (J)			HPL Knife Edge (F)			Wood Edgeband (K)		Wood Knife Edge (U)	
							A	B	E	A	B	E	A	B	A	B
Swell																
18"(457mm)	21"(533mm)	24"(610mm)	WURS-1824-	S	\$ 508.51	\$544.19	\$657.21	\$789.30	\$824.98	\$938.00	\$1040.67	\$1100.13	\$1434.28	\$1493.74		
		30"(762mm)	WURS-1830-	S	561.02	600.42	725.26	857.56	896.96	1021.80	1145.43	1210.95	1566.74	1632.26		
		36"(914mm)	WURS-1836-	S	614.54	657.66	794.32	929.98	973.10	1109.76	1250.19	1321.77	1704.74	1776.32		
		42"(1067mm)	WURS-1842-	S	668.06	714.90	863.38	1002.40	1049.24	1197.72	1354.95	1432.59	1842.74	1920.38		
		48"(1219mm)	WURS-1848-	S	721.58	772.14	932.44	1074.82	1125.38	1285.68	1459.71	1543.41	1980.74	2064.44		
		54"(1372mm)	WURS-1854-	S	775.10	829.38	1001.50	1147.24	1201.52	1373.64	1564.47	1654.23	2187.74	2208.50		
		60"(1524mm)	WURS-1860-	S	828.62	886.62	1070.56	1219.66	1277.66	1461.60	1669.23	1765.05	2256.74	2352.56		
24"(610mm)	27"(686mm)	24"(610mm)	WURS-2424-	S	\$ 526.33	\$562.01	\$675.03	\$814.97	\$850.65	\$963.67	\$1076.39	\$1135.85	\$1479.83	\$1539.29		
		30"(762mm)	WURS-2430-	S	578.84	618.24	743.08	883.23	922.63	1047.47	1187.15	1252.67	1618.29	1683.81		
		36"(914mm)	WURS-2436-	S	632.36	675.48	812.14	955.65	998.77	1135.43	1297.91	1369.49	1762.29	1833.87		
		42"(1067mm)	WURS-2442-	S	685.88	732.72	881.20	1028.07	1074.91	1223.39	1408.67	1486.31	1906.29	1983.93		
		48"(1219mm)	WURS-2448-	S	739.40	789.96	950.26	1100.49	1151.05	1311.35	1519.43	1603.13	2050.29	2133.99		
		54"(1372mm)	WURS-2454-	S	792.92	847.20	1019.32	1172.91	1227.19	1399.31	1630.19	1719.95	2194.29	2284.05		
		60"(1524mm)	WURS-2460-	S	846.44	904.44	1088.38	1245.33	1303.33	1487.27	1740.95	1836.77	2338.29	2434.11		
30"(762mm)	33"(838mm)	24"(610mm)	WURS-3024-	S	\$ 688.87	\$724.55	\$837.57	\$1028.37	\$1064.05	\$1177.07	\$1413.34	\$1472.80	\$1905.10	\$1964.56		
		30"(762mm)	WURS-3030-	S	741.38	780.78	905.62	1096.63	1136.03	1260.87	1529.80	1595.32	2049.26	2114.78		
		36"(914mm)	WURS-3036-	S	794.90	838.02	974.68	1169.05	1212.17	1348.83	1646.26	1717.84	2198.96	2270.54		
		42"(1067mm)	WURS-3042-	S	848.42	895.26	1043.74	1241.47	1288.31	1436.79	1762.72	1840.36	2348.66	2426.30		
		48"(1219mm)	WURS-3048-	S	901.94	952.50	1112.80	1313.89	1364.45	1524.75	1879.18	1962.88	2498.36	2582.06		
		54"(1372mm)	WURS-3054-	S	955.46	1009.74	1181.86	1386.31	1440.59	1612.71	1995.64	2085.40	2648.06	2737.82		
		60"(1524mm)	WURS-3060-	S	1008.98	1066.98	1250.92	1458.73	1516.73	1700.67	2112.10	2207.92	2797.76	2893.58		
Inverse Swell																
18"(457mm)	15"(381mm)	24"(610mm)	WURW-1824-	S	\$ 486.57	\$520.70	\$628.87	\$755.30	\$789.43	\$897.60	\$1089.84	\$1146.73	\$1466.51	\$1523.40		
		30"(762mm)	WURW-1830-	S	536.69	574.18	693.75	820.62	858.11	977.68	1190.04	1252.57	1593.21	1655.74		
		36"(914mm)	WURW-1836-	S	587.75	628.60	759.57	889.92	930.77	1061.74	1290.24	1358.41	1725.21	1793.38		
		42"(1067mm)	WURW-1842-	S	638.81	683.02	825.39	959.22	1003.43	1145.80	1390.44	1464.25	1857.21	1931.02		
		48"(1219mm)	WURW-1848-	S	689.87	737.44	891.21	1028.52	1076.09	1229.86	1490.64	1570.09	1989.21	2068.66		
		54"(1372mm)	WURW-1854-	S	740.93	791.86	957.03	1097.82	1148.75	1313.92	1590.84	1675.93	2121.21	2206.30		
		60"(1524mm)	WURW-1860-	S	791.99	846.28	1022.85	1167.12	1221.41	1397.98	1691.04	1781.77	2253.21	2343.94		
24"(610mm)	21"(533mm)	24"(610mm)	WURW-2424-	S	\$ 503.63	\$537.76	\$645.93	\$779.85	\$813.98	\$922.15	\$1124.00	\$1180.89	\$1510.04	\$1566.93		
		30"(762mm)	WURW-2430-	S	553.75	591.24	710.81	845.17	882.66	1002.23	1229.90	1292.43	1642.44	1704.97		
		36"(914mm)	WURW-2436-	S	604.81	645.66	776.63	914.47	955.32	1086.29	1335.80	1403.97	1780.14	1848.31		
		42"(1067mm)	WURW-2442-	S	655.87	700.08	842.45	983.77	1027.98	1170.35	1441.70	1515.51	1917.84	1991.65		
		48"(1219mm)	WURW-2448-	S	706.93	754.50	908.27	1053.07	1100.64	1254.41	1547.60	1627.05	2055.54	2134.99		
		54"(1372mm)	WURW-2454-	S	757.99	808.92	974.09	1122.37	1173.30	1338.47	1653.50	1738.59	2193.24	2278.33		
		60"(1524mm)	WURW-2460-	S	809.05	863.34	1039.91	1191.67	1245.96	1422.53	1759.40	1850.13	2330.94	2421.67		
30"(762mm)	27"(686mm)	24"(610mm)	WURW-3024-	S	\$ 659.17	\$693.30	\$801.47	\$984.10	\$1018.23	\$1126.40	\$1446.45	\$1503.34	\$1917.02	\$1973.91		
		30"(762mm)	WURW-3030-	S	709.29	746.78	866.35	1049.42	1086.91	1206.48	1558.05	1620.58	2055.12	2117.65		
		36"(914mm)	WURW-3036-	S	760.35	801.20	932.17	1118.72	1159.57	1290.54	1669.65	1737.82	2198.52	2266.69		
		42"(1067mm)	WURW-3042-	S	811.41	855.62	997.99	1188.02	1232.23	1374.60	1781.25	1855.06	2341.92	2415.73		
		48"(1219mm)	WURW-3048-	S	862.47	910.04	1063.81	1257.32	1304.89	1458.66	1892.85	1972.30	2485.32	2564.77		
		54"(1372mm)	WURW-3054-	S	913.53	964.46	1129.63	1326.62	1377.55	1542.72	2004.45	2089.54	2628.72	2713.81		
		60"(1524mm)	WURW-3060-	S	964.59	1018.88	1195.45	1395.92	1450.21	1626.78	2116.05	2206.78	2772.12	2862.85		

Adaptable Worksurfaces — Rectangular

Wedge/Sharp Wedge

Wedge

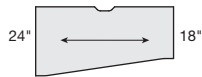
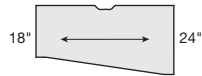
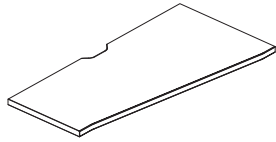

WURE-N34
WURE-N43

Sharp Wedge



Class CA

Unique Specification

- Suggested pedestal style is mobile.

To Order, Specify:

1) Product number, including:

1 Surface Option:

- L** Laminate
- W** Wood

2 Edge Option:

Laminate:

- J** Edgeband
- F** Knife

Wood:

- K** Edgeband
- U** Knife

3 Wireway/Cutout Option:

- A** Notched
- C** Without
- H** Belong Hatch

2) Laminate color or Wood finish color.

3) Edge trim color (laminite only).

Left/Right Depth	Width	Number 1 2 3	HPL Edgeband (J)			HPL Knife Edge (F)			Wood Edgeband (K)		Wood Knife Edge (U)	
			A	B	E	A	B	E	A	B	A	B
Wedge												
24"(610mm)/18"(457mm)	24"(610mm)	WURE-2424- S N43	\$ 757.65	\$ 797.90	\$ 918.13	\$1046.28	\$1086.53	\$ 1206.76	\$ 1398.89	\$ 1429.55	\$ 1782.93	\$ 1813.59
	30"(762mm)	WURE-2430- S N43	822.09	866.90	1000.99	1136.04	1180.85	1314.94	1536.77	1584.59	1962.33	2010.15
	36"(914mm)	WURE-2436- S N43	886.53	935.90	1083.85	1225.80	1275.17	1423.12	1674.65	1739.63	2141.73	2206.71
	42"(1067mm)	WURE-2442- S N43	950.97	1004.90	1166.71	1315.56	1369.49	1531.30	1812.53	1894.67	2321.13	2403.27
	48"(1219mm)	WURE-2448- S N43	1015.41	1073.90	1249.57	1405.32	1463.81	1639.48	1950.41	2049.71	2500.53	2599.83
	54"(1372mm)	WURE-2454- S N43	1079.85	1142.90	1332.43	1495.08	1558.13	1747.66	2088.29	2204.75	2679.93	2796.39
	60"(1524mm)	WURE-2460- S N43	1144.29	1211.90	1415.29	1584.84	1652.45	1855.84	2226.17	2359.79	2859.33	2992.95
	66"(1676mm)	WURE-2466- S N43	1208.73	1280.90	1498.15	1674.60	1746.77	1964.02	2364.05	2514.83	3038.73	3189.51
	72"(1829mm)	WURE-2472- S N43	1273.17	1349.90	1581.01	1764.36	1841.09	2072.20	2501.93	2669.87	3218.13	3386.07
	78"(1981mm)	WURE-2478- S N43	1337.61	1418.90	1663.87	1854.12	1935.41	2180.38	2639.81	2824.91	3397.53	3582.63
	84"(2134mm)	WURE-2484- S N43	1402.05	1487.90	1746.73	1943.88	2029.73	2288.56	2777.69	2979.95	3576.93	3779.19
	90"(2286mm)	WURE-2490- S N43	1466.49	1556.90	1829.59	2033.64	2124.05	2396.74	2915.57	3134.99	3756.33	3975.75
	96"(2438mm)	WURE-2496- S N43	1530.93	1625.90	1912.45	2123.40	2218.37	2504.92	3053.45	3290.03	3935.73	4172.31
	102"(2591mm)	WURE-24A2- S N43	1595.37	1694.90	1995.31	2213.16	2312.69	2613.10	3191.33	3445.07	4115.13	4368.87
	108"(2743mm)	WURE-24A8- S N43	1659.81	1763.90	2078.17	2302.92	2407.01	2721.28	3329.21	3600.11	4294.53	4565.43
	114"(2896mm)	WURE-24B4- S N43	1702.77	1809.90	2133.41	2362.76	2469.89	2793.40	3421.13	3703.47	4414.13	4696.47
	120"(3048mm)	WURE-24CO- S N43	1788.69	1901.90	2243.89	2482.44	2595.65	2937.64	3604.97	3910.19	4653.33	4958.55

Adaptable Worksurfaces — Rectangular

Wedge/Sharp Wedge

Left/Right Depth	Width	Number ①② ③	HPL Edgeband (J)			HPL Knife Edge (F)			Wood Edgeband (K)		Wood Knife Edge (U)	
			A	B	E	A	B	E	A	B	A	B
18"(457mm)/24"(610mm)	24"(610mm)	WURE-2424- S N34	\$ 757.65	\$ 797.90	\$ 918.13	\$ 1046.28	\$ 1086.53	\$ 1206.76	\$ 1398.89	\$ 1429.55	\$ 1782.93	\$ 1813.59
	30"(762mm)	WURE-2430- S N34	822.09	866.90	1000.99	1136.04	1180.85	1314.94	1536.77	1584.59	1962.33	2010.15
	36"(914mm)	WURE-2436- S N34	886.53	935.90	1083.85	1225.80	1275.17	1423.12	1674.65	1739.63	2141.73	2206.71
	42"(1067mm)	WURE-2442- S N34	950.97	1004.90	1166.71	1315.56	1369.49	1531.30	1812.53	1894.67	2321.13	2403.27
	48"(1219mm)	WURE-2448- S N34	1015.41	1073.90	1249.57	1405.32	1463.81	1639.48	1950.41	2049.71	2500.53	2599.83
	54"(1372mm)	WURE-2454- S N34	1079.85	1142.90	1332.43	1495.08	1558.13	1747.66	2088.29	2204.75	2679.93	2796.39
	60"(1524mm)	WURE-2460- S N34	1144.29	1211.90	1415.29	1584.84	1652.45	1855.84	2226.17	2359.79	2859.33	2992.95
	66"(1676mm)	WURE-2466- S N34	1208.73	1280.90	1498.15	1674.60	1746.77	1964.02	2364.05	2514.83	3038.73	3189.51
	72"(1829mm)	WURE-2472- S N34	1273.17	1349.90	1581.01	1764.36	1841.09	2072.20	2501.93	2669.87	3218.13	3386.07
	78"(1981mm)	WURE-2478- S N34	1337.61	1418.90	1663.87	1854.12	1935.41	2180.38	2639.81	2824.91	3397.53	3582.63
	84"(2134mm)	WURE-2484- S N34	1402.05	1487.90	1746.73	1943.88	2029.73	2288.56	2777.69	2979.95	3576.93	3779.19
	90"(2286mm)	WURE-2490- S N34	1466.49	1556.90	1829.59	2033.64	2124.05	2396.74	2915.57	3134.99	3756.33	3975.75
	96"(2438mm)	WURE-2496- S N34	1530.93	1625.90	1912.45	2123.40	2218.37	2504.92	3053.45	3290.03	3935.73	4172.31
	102"(2591mm)	WURE-24A2- S N34	1595.37	1694.90	1995.31	2213.16	2312.69	2613.10	3191.33	3445.07	4115.13	4368.87
108"(2743mm)	WURE-24A8- S N34	1659.81	1763.90	2078.17	2302.92	2407.01	2721.28	3329.21	3600.11	4294.53	4565.43	
114"(2896mm)	WURE-24B4- S N34	1702.77	1809.90	2133.41	2362.76	2469.89	2793.40	3421.13	3703.47	4414.13	4696.47	
120"(3048mm)	WURE-24CO- S N34	1788.69	1901.90	2243.89	2482.44	2595.65	2937.64	3604.97	3910.19	4653.33	4958.55	
30"(762mm)/24"(610mm)	24"(610mm)	WURE-3024- S N54	\$ 776.79	\$ 817.04	\$ 937.27	\$ 1065.42	\$ 1105.67	\$ 1225.90	\$ 1418.03	\$ 1448.69	\$ 1802.07	\$ 1832.73
	30"(762mm)	WURE-3030- S N54	841.23	886.04	1020.13	1155.18	1199.99	1334.08	1555.91	1603.73	1981.47	2029.29
	36"(914mm)	WURE-3036- S N54	905.67	955.04	1102.99	1244.94	1294.31	1442.26	1693.79	1758.77	2160.87	2225.85
	42"(1067mm)	WURE-3042- S N54	970.11	1024.04	1185.85	1334.70	1388.63	1550.44	1831.67	1913.81	2340.27	2422.41
	48"(1219mm)	WURE-3048- S N54	1034.55	1093.04	1268.71	1424.46	1482.95	1658.62	1969.55	2068.85	2519.67	2618.97
	54"(1372mm)	WURE-3054- S N54	1098.99	1162.04	1351.57	1514.22	1577.27	1766.80	2107.43	2223.89	2699.07	2815.53
	60"(1524mm)	WURE-3060- S N54	1163.43	1231.04	1434.43	1603.98	1671.59	1874.98	2245.31	2378.93	2878.47	3012.09
	66"(1676mm)	WURE-3066- S N54	1227.87	1300.04	1517.29	1693.74	1765.91	1983.16	2383.19	2533.97	3057.87	3208.65
	72"(1829mm)	WURE-3072- S N54	1292.31	1369.04	1600.15	1783.50	1860.23	2091.34	2521.07	2689.01	3237.27	3405.21
	78"(1981mm)	WURE-3078- S N54	1356.75	1438.04	1683.01	1873.26	1954.55	2199.52	2658.95	2844.05	3416.67	3601.77
	84"(2134mm)	WURE-3084- S N54	1421.19	1507.04	1765.87	1963.02	2048.87	2307.70	2796.83	2999.09	3596.07	3798.33
	90"(2286mm)	WURE-3090- S N54	1485.63	1576.04	1848.73	2052.78	2143.19	2415.88	2934.71	3154.13	3775.47	3994.89
	96"(2438mm)	WURE-3096- S N54	1550.07	1645.04	1931.59	2142.54	2237.51	2524.06	3072.59	3309.17	3954.87	4191.45
	102"(2591mm)	WURE-30A2- S N54	1614.51	1714.04	2014.45	2232.30	2331.83	2632.24	3210.47	3464.21	4134.27	4388.01
108"(2743mm)	WURE-30A8- S N54	1678.95	1783.04	2097.31	2322.06	2426.15	2740.42	3348.35	3619.25	4313.67	4584.57	
114"(2896mm)	WURE-30B4- S N54	1721.91	1829.04	2152.55	2381.90	2489.03	2812.54	3440.27	3722.61	4433.27	4715.61	
120"(3048mm)	WURE-30CO- S N54	1807.83	1921.04	2263.03	2501.58	2614.79	2956.78	3624.11	3929.33	4672.47	4977.69	
24"(610mm)/30"(762mm)	24"(610mm)	WURE-3024- S N45	\$ 776.79	\$ 817.04	\$ 937.27	\$ 1065.42	\$ 1105.67	\$ 1225.90	\$ 1418.03	\$ 1448.69	\$ 1802.07	\$ 1832.73
	30"(762mm)	WURE-3030- S N45	841.23	886.04	1020.13	1155.18	1199.99	1334.08	1555.91	1603.73	1981.47	2029.29
	36"(914mm)	WURE-3036- S N45	905.67	955.04	1102.99	1244.94	1294.31	1442.26	1693.79	1758.77	2160.87	2225.85
	42"(1067mm)	WURE-3042- S N45	970.11	1024.04	1185.85	1334.70	1388.63	1550.44	1831.67	1913.81	2340.27	2422.41
	48"(1219mm)	WURE-3048- S N45	1034.55	1093.04	1268.71	1424.46	1482.95	1658.62	1969.55	2068.85	2519.67	2618.97
	54"(1372mm)	WURE-3054- S N45	1098.99	1162.04	1351.57	1514.22	1577.27	1766.80	2107.43	2223.89	2699.07	2815.53
	60"(1524mm)	WURE-3060- S N45	1163.43	1231.04	1434.43	1603.98	1671.59	1874.98	2245.31	2378.93	2878.47	3012.09
	66"(1676mm)	WURE-3066- S N45	1227.87	1300.04	1517.29	1693.74	1765.91	1983.16	2383.19	2533.97	3057.87	3208.65
	72"(1829mm)	WURE-3072- S N45	1292.31	1369.04	1600.15	1783.50	1860.23	2091.34	2521.07	2689.01	3237.27	3405.21
	78"(1981mm)	WURE-3078- S N45	1356.75	1438.04	1683.01	1873.26	1954.55	2199.52	2658.95	2844.05	3416.67	3601.77
	84"(2134mm)	WURE-3084- S N45	1421.19	1507.04	1765.87	1963.02	2048.87	2307.70	2796.83	2999.09	3596.07	3798.33
	90"(2286mm)	WURE-3090- S N45	1485.63	1576.04	1848.73	2052.78	2143.19	2415.88	2934.71	3154.13	3775.47	3994.89
	96"(2438mm)	WURE-3096- S N45	1550.07	1645.04	1931.59	2142.54	2237.51	2524.06	3072.59	3309.17	3954.87	4191.45
	102"(2591mm)	WURE-30A2- S N45	1614.51	1714.04	2014.45	2232.30	2331.83	2632.24	3210.47	3464.21	4134.27	4388.01
108"(2743mm)	WURE-30A8- S N45	1678.95	1783.04	2097.31	2322.06	2426.15	2740.42	3348.35	3619.25	4313.67	4584.57	
114"(2896mm)	WURE-30B4- S N45	1721.91	1829.04	2152.55	2381.90	2489.03	2812.54	3440.27	3722.61	4433.27	4715.61	
120"(3048mm)	WURE-30CO- S N45	1807.83	1921.04	2263.03	2501.58	2614.79	2956.78	3624.11	3929.33	4672.47	4977.69	

Adaptable Worksurfaces — Rectangular

Wedge/Sharp Wedge

Left/Right Depth	Width	Number ①② ③	HPL Edgeband (J)			HPL Knife Edge (F)			Wood Edgeband (K)		Wood Knife Edge (U)			
			A	B	E	A	B	E	A	B	A	B		
Sharp Wedge														
24"(610mm)/18"(457mm)	24"(610mm)	WURG-2424-	S	N43	\$ 732.06	\$ 774.40	\$ 900.51	\$1023.78	\$1066.12	\$ 1192.23	\$1406.72	\$ 1528.00	\$ 1805.76	\$ 1927.04
	30"(762mm)	WURG-2430-	S	N43	804.10	846.57	989.22	1120.06	1162.53	1305.18	1554.60	1702.17	1997.73	2145.30
	36"(914mm)	WURG-2436-	S	N43	876.14	918.74	1077.93	1216.34	1258.94	1418.13	1702.48	1876.34	2189.70	2363.56
	42"(1067mm)	WURG-2442-	S	N43	948.18	990.91	1166.64	1312.62	1355.35	1531.08	1850.36	2050.51	2381.67	2581.82
	48"(1219mm)	WURG-2448-	S	N43	1020.22	1063.08	1255.35	1408.90	1451.76	1644.03	1998.24	2224.68	2573.64	2800.08
	54"(1372mm)	WURG-2454-	S	N43	1092.26	1135.25	1344.06	1505.18	1548.17	1756.98	2146.12	2398.85	2765.61	3018.34
	60"(1524mm)	WURG-2460-	S	N43	1164.30	1207.42	1432.77	1601.46	1644.58	1869.93	2294.00	2573.02	2957.58	3236.60
18"(457mm)/24"(610mm)	24"(610mm)	WURG-2424-	S	N34	\$ 732.06	\$ 774.40	\$ 900.51	\$1023.78	\$1066.12	\$ 1192.23	\$1406.72	\$ 1528.00	\$ 1805.76	\$ 1927.04
	30"(762mm)	WURG-2430-	S	N34	804.10	846.57	989.22	1120.06	1162.53	1305.18	1554.60	1702.17	1997.73	2145.30
	36"(914mm)	WURG-2436-	S	N34	876.14	918.74	1077.93	1216.34	1258.94	1418.13	1702.48	1876.34	2189.70	2363.56
	42"(1067mm)	WURG-2442-	S	N34	948.18	990.91	1166.64	1312.62	1355.35	1531.08	1850.36	2050.51	2381.67	2581.82
	48"(1219mm)	WURG-2448-	S	N34	1020.22	1063.08	1255.35	1408.90	1451.76	1644.03	1998.24	2224.68	2573.64	2800.08
	54"(1372mm)	WURG-2454-	S	N34	1092.26	1135.25	1344.06	1505.18	1548.17	1756.98	2146.12	2398.85	2765.61	3018.34
	60"(1524mm)	WURG-2460-	S	N34	1164.30	1207.42	1432.77	1601.46	1644.58	1869.93	2294.00	2573.02	2957.58	3236.60
30"(762mm)/24"(610mm)	24"(610mm)	WURG-3024-	S	N54	\$ 742.64	\$ 785.53	\$ 915.07	\$1043.60	\$1086.49	\$ 1216.03	\$ 1435.01	\$ 1561.33	\$ 1834.05	\$ 1960.37
	30"(762mm)	WURG-3030-	S	N54	814.68	857.70	1003.78	1139.88	1182.90	1328.98	1582.89	1735.50	2026.02	2178.63
	36"(914mm)	WURG-3036-	S	N54	886.72	929.87	1092.49	1236.16	1279.31	1441.93	1730.77	1909.67	2217.99	2396.89
	42"(1067mm)	WURG-3042-	S	N54	958.76	1002.04	1181.20	1332.44	1375.72	1554.88	1878.65	2083.84	2409.96	2615.15
	48"(1219mm)	WURG-3048-	S	N54	1030.80	1074.21	1269.91	1428.72	1472.13	1667.83	2026.53	2258.01	2601.93	2833.41
	54"(1372mm)	WURG-3054-	S	N54	1102.84	1146.38	1358.62	1525.00	1568.54	1780.78	2174.41	2432.18	2793.90	3051.67
	60"(1524mm)	WURG-3060-	S	N54	1174.88	1218.55	1447.33	1621.28	1664.95	1893.73	2322.29	2606.35	2985.87	3269.93
24"(610mm)/30"(762mm)	24"(610mm)	WURG-3024-	S	N45	\$ 742.64	\$ 785.53	\$ 915.07	\$1043.60	\$1086.49	\$ 1216.03	\$ 1435.01	\$ 1561.33	\$ 1834.05	\$ 1960.37
	30"(762mm)	WURG-3030-	S	N45	814.68	857.70	1003.78	1139.88	1182.90	1328.98	1582.89	1735.50	2026.02	2178.63
	36"(914mm)	WURG-3036-	S	N45	886.72	929.87	1092.49	1236.16	1279.31	1441.93	1730.77	1909.67	2217.99	2396.89
	42"(1067mm)	WURG-3042-	S	N45	958.76	1002.04	1181.20	1332.44	1375.72	1554.88	1878.65	2083.84	2409.96	2615.15
	48"(1219mm)	WURG-3048-	S	N45	1030.80	1074.21	1269.91	1428.72	1472.13	1667.83	2026.53	2258.01	2601.93	2833.41
	54"(1372mm)	WURG-3054-	S	N45	1102.84	1146.38	1358.62	1525.00	1568.54	1780.78	2174.41	2432.18	2793.90	3051.67
	60"(1524mm)	WURG-3060-	S	N45	1174.88	1218.55	1447.33	1621.28	1664.95	1893.73	2322.29	2606.35	2985.87	3269.93

Adaptable Worksurfaces — Rectangular

Rectangular Radius End



(Right-hand orientation)



(Left-hand orientation)

WURR
Class CA

Unique Specifications

- Separately specified floor support required on radius end:
–Side/corner bracket with work surface support leg or column.
- Worksurfaces less than 42”(1067mm)W, suggested pedestal style is mobile.
- Laminate work surface will have 3mm edgeband or knife edge on user edge and side and 1mm edgeband on remaining side and back.

To Order, Specify:

1) Product number, including:

1 Surface Option:

- L** Laminate
- W** Wood

2 Edge Option:

Laminate:

- J** Edgeband
- F** Knife

Wood:

- K** Edgeband
- U** Knife

3 Wireway Option:

- A** Notched
- C** Without

4 Orientation (as seated):

- R** Right-hand
- L** Left-hand

2) Laminate color or Wood finish color.

3) Edge trim color (laminite only).

Depth	Width	Number 1 2 3 4	HPL Edgeband (J)			HPL Knife Edge (F)			Wood Edgeband (K)		Wood Knife Edge (U)	
			A	B	E	A	B	E	A	B	A	B
18"(457mm)	24"(610mm)	WURR-1824- S	\$ 568.14	\$ 602.27	\$ 705.66	\$ 833.11	\$ 867.24	\$ 970.63	\$ 1156.21	\$ 1207.43	\$ 1530.14	\$ 1581.36
	30"(762mm)	WURR-1830- S	634.28	672.85	789.26	914.45	953.02	1069.43	1291.87	1348.73	1725.60	1782.46
	36"(914mm)	WURR-1836- S	701.36	744.37	873.80	999.77	1042.78	1172.21	1427.53	1490.03	1933.02	1995.52
	42"(1067mm)	WURR-1842- S	768.44	815.89	958.34	1085.09	1132.54	1274.99	1563.19	1631.33	2140.44	2208.58
	48"(1219mm)	WURR-1848- S	835.52	887.41	1042.88	1170.41	1222.30	1377.77	1698.85	1772.63	2347.86	2421.64
	54"(1372mm)	WURR-1854- S	902.60	958.93	1127.42	1255.73	1312.06	1480.55	1834.51	1913.93	2555.28	2634.70
60"(1524mm)	WURR-1860- S	969.68	1030.45	1211.96	1341.05	1401.82	1583.33	1970.17	2055.23	2762.70	2847.76	
24"(610mm)	24"(610mm)	WURR-2424- S	\$ 581.45	\$ 615.58	\$ 718.97	\$ 850.18	\$ 884.31	\$ 987.70	\$ 1171.41	\$ 1222.63	\$ 1554.74	\$ 1605.96
	30"(762mm)	WURR-2430- S	647.59	686.16	802.57	931.52	970.09	1086.50	1310.31	1367.17	1753.44	1810.30
	36"(914mm)	WURR-2436- S	714.67	757.68	887.11	1016.84	1059.85	1189.28	1449.21	1511.71	1964.10	2026.60
	42"(1067mm)	WURR-2442- S	781.75	829.20	971.65	1102.16	1149.61	1292.06	1588.11	1656.25	2174.76	2242.90
	48"(1219mm)	WURR-2448- S	848.83	900.72	1056.19	1187.48	1239.37	1394.84	1727.01	1800.79	2385.42	2459.20
	54"(1372mm)	WURR-2454- S	915.91	972.24	1140.73	1272.80	1329.13	1497.62	1865.91	1945.33	2596.08	2675.50
60"(1524mm)	WURR-2460- S	982.99	1043.76	1225.27	1358.12	1418.89	1600.40	2004.81	2089.87	2806.74	2891.80	
30"(762mm)	24"(610mm)	WURR-3024- S	\$ 759.71	\$ 793.84	\$ 897.23	\$ 1097.72	\$ 1131.85	\$ 1235.24	\$ 1418.02	\$ 1469.24	\$ 1917.79	\$ 1969.01
	30"(762mm)	WURR-3030- S	825.85	864.42	980.83	1179.06	1217.63	1334.04	1560.34	1617.20	2119.91	2176.77
	36"(914mm)	WURR-3036- S	892.93	935.94	1065.37	1264.38	1307.39	1436.82	1702.66	1765.16	2333.99	2396.49
	42"(1067mm)	WURR-3042- S	960.01	1007.46	1149.91	1349.70	1397.15	1539.60	1844.98	1913.12	2548.07	2616.21
	48"(1219mm)	WURR-3048- S	1027.09	1078.98	1234.45	1435.02	1486.91	1642.38	1987.30	2061.08	2762.15	2835.93
	54"(1372mm)	WURR-3054- S	1094.17	1150.50	1318.99	1520.34	1576.67	1745.16	2129.62	2209.04	2976.23	3055.65
60"(1524mm)	WURR-3060- S	1161.25	1222.02	1403.53	1605.66	1666.43	1847.94	2271.94	2357.00	3190.31	3275.37	

Adaptable Worksurfaces — Corner

General Specifications



WUCB-R45
WUCB-L54
Bent

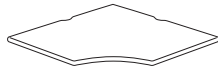

WUCR
Corner, 90° Wrap-Around

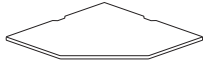

WUCA-L
Corner, 90° Straight Front



WUCT-N34
WUCT-N43
Corner 90° Wrap-Around
Transitional

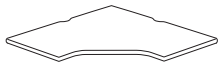

WUCN
Corner, 90° Notched



WUCH-N34
WUCH-N43
Corner, 90° Notched
Transitional



WUCX-R34
WUCX-L43
Corner, 90° Wrap-Around
Transitional Extended

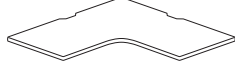

WUCQ-N44
90° Merger



WUCU
Corner, 90° Angled



WUCF-L45
WUCF-L54
Corner, 90° Angled-
Transitional

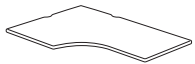

WUCE-R44
WUCE-L44
Corner, 90° Wrap-Around
Extended



WUCP-R44
WUCP-L44
Corner, 90° Notched
Extended

Common Features

- Includes worksurface and tie plate.
- Available in high-pressure laminate (HPL) or wood veneer.
- Laminate edge option:
 - (J) 3mm edgeband on user side with 1mm edgeband on sides and back.
 - (F) Knife edge on user side and 1mm edgeband on sides and back. Knife edge profile receives a clear coat finish.
- Wood veneer edge option:
 - (K) 3mm edgeband on user side with 1mm edgeband on sides and back.
 - (U) Knife edge on user side and 1mm edgeband on sides and back. Knife edge profile receives a clear coat finish.
- Worksurfaces predrilled to accept most support options.
- Optional wireway:
 - Wireway will be color-matched to solid side/back edge trim. Wood veneer or patterned/wood grain laminate will have a Charcoal wireway.
 - Refer to Specification Guide for wireway details.
- Optional Belong Hatch cutout:
 - Laminate tops only with one cutout.
 - Available on worksurfaces 30" (762mm) D and widths of 54" (1372mm) and 60" (1524mm).
 - Requires separately specified Belong Hatch.
 - Refer to Specification Guide for cutout details.
- **Installed worksurfaces without wireway will not allow clearance for power plug.**
- Depth, width and length shown in nominal dimensions.

Specification Tips

- **Corner bracket is required and must be separately specified.**
- **Worksurface support specific to product line and worksurface edge guidelines; must be separately specified.**
- Knife edge requires use of worksurface supports for that application; worksurface support panel and/or side bracket for use with knife edge.
- Intermediate support is required for unsupported worksurface span greater than 60" (1524mm).
- Not intended for use on Height Adjustable Tables.

Note: Separately specified worksurface reinforcement bar provides additional support for worksurfaces with 60" (1524mm) spans that are heavily loaded and not otherwise supported by mid-span cantilevers, worksurface support panels, columns, legs or attached lower storage.

Adaptable Worksurfaces — Corner Bent

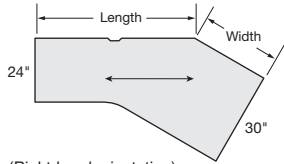

(Right-hand orientation)

WUCB-R45

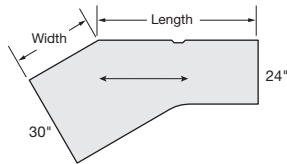

(Left-hand orientation)

WUCB-L54

Class CA

To Order, Specify:

1) Product number, including:

1 Surface Option:

- L** Laminate
- W** Wood

2 Edge Option:

Laminate:

- J** Edgeband
- F** Knife

Wood:

- K** Edgeband
- U** Knife

3 Wireway/Cutout Option:

- A** Notched
- C** Without

2) Laminate color or Wood finish color.

3) Edge trim color (laminite only).

Left/Right Depth	Width	Length	Number ①②③	HPL Edgeband (J)		HPL Knife Edge (F)		Wood Edgeband (K)		Wood Knife Edge (U)	
				A	B	A	B	A	B	A	B
24"(610mm)/30"(762mm)	24"(610mm)	36"(914mm)	WUCB-2436- S R45	\$ 1247.52	\$1336.92	\$ 1767.45	\$ 1856.85	\$ 1905.84	\$2046.02	\$ 2521.56	\$ 2661.74
		42"(1067mm)	WUCB-2442- S R45	1406.50	1507.28	1978.04	2078.82	2075.99	2246.47	2749.87	2920.35
		48"(1219mm)	WUCB-2448- S R45	1667.06	1779.22	2290.21	2402.37	2550.88	2751.66	3282.92	3483.70
		60"(1524mm)	WUCB-2460- S R45	1883.44	2018.36	2609.81	2744.73	2992.76	3254.14	3841.12	4102.50
24"(610mm)/30"(762mm)	30"(762mm)	36"(914mm)	WUCB-3036- S R45	\$ 1406.50	\$1507.28	\$ 1978.04	\$ 2078.82	\$2075.99	\$2246.47	\$ 2749.87	\$2920.35
		42"(1067mm)	WUCB-3042- S R45	1565.48	1677.64	2188.63	2300.79	2246.14	2446.92	2978.18	3178.96
		48"(1219mm)	WUCB-3048- S R45	1826.04	1949.58	2500.80	2624.34	2721.03	2952.11	3511.23	3742.31
		60"(1524mm)	WUCB-3060- S R45	2042.42	2188.72	2820.40	2966.70	3162.91	3454.59	4069.43	4361.11
30"(762mm)/24"(610mm)	24"(610mm)	36"(914mm)	WUCB-2436- S L54	\$ 1247.52	\$1336.92	\$ 1767.45	\$ 1856.85	\$ 1905.84	\$2046.02	\$ 2521.56	\$ 2661.74
		42"(1067mm)	WUCB-2442- S L54	1406.50	1507.28	1978.04	2078.82	2075.99	2246.47	2749.87	2920.35
		48"(1219mm)	WUCB-2448- S L54	1667.06	1779.22	2290.21	2402.37	2550.88	2751.66	3282.92	3483.70
		60"(1524mm)	WUCB-2460- S L54	1883.44	2018.36	2609.81	2744.73	2992.76	3254.14	3841.12	4102.50
30"(762mm)/24"(610mm)	30"(762mm)	36"(914mm)	WUCB-3036- S L54	\$ 1406.50	\$1507.28	\$ 1978.04	\$ 2078.82	\$2075.99	\$2246.47	\$ 2749.87	\$2920.35
		42"(1067mm)	WUCB-3042- S L54	1565.48	1677.64	2188.63	2300.79	2246.14	2446.92	2978.18	3178.96
		48"(1219mm)	WUCB-3048- S L54	1826.04	1949.58	2500.80	2624.34	2721.03	2952.11	3511.23	3742.31
		60"(1524mm)	WUCB-3060- S L54	2042.42	2188.72	2820.40	2966.70	3162.91	3454.59	4069.43	4361.11

Adaptable Worksurfaces — Corner

Merger Corner – 90°

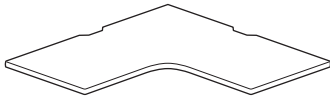

Unique Specifications

- 90° Merger is suggested alternative to using two perpendicular rectangular worksurfaces.
- Not designed for use with an adjustable keyboard pad.

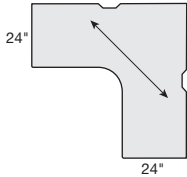

WUCQ-N44
Class CA

To Order, Specify:

1) Product number, including:

1 Surface Option:

- L** Laminate
- W** Wood

2 Edge Option:

Laminate:

- J** Edgeband
- F** Knife

Wood:

- K** Edgeband
- U** Knife

3 Wireway Option:

- A** Notched
- C** Without

2) Laminate color or Wood finish color.

3) Edge trim color (laminite only).

Depth	Width	Number	① ② ③	HPL Edgeband (J)		HPL Knife Edge (F)		Wood Edgeband (K)		Wood Knife Edge (U)	
				A	B	A	B	A	B	A	B
18"(457mm)	36"(914mm)	WUCQ-3636-	S N33	\$ 932.37	\$ 988.42	\$ 1312.76	\$ 1368.81	\$1443.91	\$1488.65	\$ 1885.03	\$ 1929.77
	42"(1067mm)	WUCQ-4242-	S N33	1019.90	1075.95	1492.82	1548.87	1597.54	1642.28	1972.56	2017.30
	48"(1219mm)	WUCQ-4848-	S N33	1212.37	1268.42	1733.19	1789.24	1838.64	1883.38	2444.05	2488.79
	54"(1372mm)	WUCQ-5454-	S N33	1406.80	1462.85	1988.99	2045.04	N/A	N/A	N/A	N/A
24"(610mm)	36"(914mm)	WUCQ-3636-	S N44	\$ 967.39	\$1023.44	\$ 1347.78	\$ 1403.83	\$1478.93	\$1523.67	\$ 1920.05	\$ 1964.79
	42"(1067mm)	WUCQ-4242-	S N44	1054.92	1110.97	1527.84	1583.89	1632.56	1677.30	2007.58	2052.32
	48"(1219mm)	WUCQ-4848-	S N44	1247.39	1303.44	1768.21	1824.26	1873.66	1918.40	2479.07	2523.81
	54"(1372mm)	WUCQ-5454-	S N44	1441.82	1497.87	2024.01	2080.06	N/A	N/A	N/A	N/A
30"(762mm)	36"(914mm)	WUCQ-3636-	S N55	\$ 1115.14	\$ 1171.19	\$ 1495.53	\$ 1551.58	\$1626.68	\$ 1671.42	\$2067.80	\$ 2112.54
	42"(1067mm)	WUCQ-4242-	S N55	1202.67	1258.72	1675.59	1731.64	1780.31	1825.05	2155.33	2200.07
	48"(1219mm)	WUCQ-4848-	S N55	1395.14	1451.19	1915.96	1972.01	N/A	N/A	N/A	N/A
	54"(1372mm)	WUCQ-5454-	S N55	1589.57	1645.62	2171.76	2227.81	N/A	N/A	N/A	N/A

Adaptable Worksurfaces — Corner

Straight Front Corner – 90°

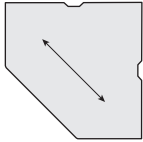
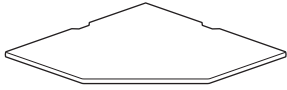

WUCA-L
Class CA

To Order, Specify:

1) Product number, including:

1 Surface Option:

- L** Laminate
- W** Wood

2 Edge Option:

Laminate:

- J** Edgeband
- F** Knife

Wood:

- K** Edgeband
- U** Knife

3 Wireway Option:

- A** Notched
- C** Without

2) Laminate color or Wood finish color.

3) Edge trim color (laminite only).

Depth	Width	Number	① ② ③	HPL Edgeband (J)		HPL Knife Edge (F)		Wood Edgeband (K)		Wood Knife Edge (U)	
				A	B	A	B	A	B	A	B
18"(457mm)	36"(914mm)	WUCA-3636-	■ S N33	\$1028.22	\$1084.86	\$1404.82	\$ 1461.46	\$1494.29	\$ 1558.46	\$ 1938.97	\$2003.14
	42"(1067mm)	WUCA-4242-	■ S N33	1096.94	1162.29	1510.16	1575.51	1626.45	1722.72	2123.08	2219.35
	48"(1219mm)	WUCA-4848-	■ S N33	1271.37	1345.43	1721.21	1795.27	1864.32	1992.69	2412.90	2541.27
	54"(1372mm)	WUCA-5454-	■ S N33	1332.52	1415.29	1818.98	1901.75	N/A	N/A	N/A	N/A
24"(610mm)	36"(914mm)	WUCA-3636-	■ S N44	\$1062.19	\$ 1118.83	\$1438.79	\$1495.43	\$1528.26	\$ 1592.43	\$ 1972.94	\$ 2037.11
	42"(1067mm)	WUCA-4242-	■ S N44	1130.91	1196.26	1544.13	1609.48	1660.42	1756.69	2157.05	2253.32
	48"(1219mm)	WUCA-4848-	■ S N44	1305.34	1379.40	1755.18	1829.24	1898.29	2026.66	2446.87	2575.24
	54"(1372mm)	WUCA-5454-	■ S N44	1366.49	1449.26	1852.95	1935.72	N/A	N/A	N/A	N/A
30"(762mm)	36"(914mm)	WUCA-3636-	■ S N55	\$1205.67	\$1262.31	\$1582.27	\$1638.91	\$ 1671.74	\$ 1735.91	\$ 2116.42	\$ 2180.59
	42"(1067mm)	WUCA-4242-	■ S N55	1274.39	1339.74	1687.61	1752.96	1803.90	1900.17	2300.53	2396.80
	48"(1219mm)	WUCA-4848-	■ S N55	1448.82	1522.88	1898.66	1972.72	N/A	N/A	N/A	N/A
	54"(1372mm)	WUCA-5454-	■ S N55	1509.97	1592.74	1996.43	2079.20	N/A	N/A	N/A	N/A

Adaptable Worksurfaces — Corner

Wrap-Around Corner – 90°

Wrap-Around

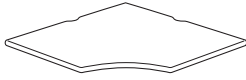

WUCR

Wrap-Around Transitional

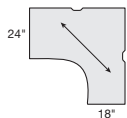
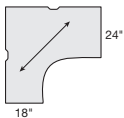
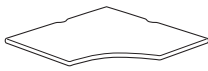

WUCT
Class CA

To Order, Specify:

1) Product number, including:

1 Surface Option:

- L** Laminate
- W** Wood

2 Edge Option:

Laminate:

- J** Edgeband
- F** Knife

Wood:

- K** Edgeband
- U** Knife

3 Wireway Option:

- A** Notched
- C** Without

2) Laminate color or Wood finish color.

3) Edge trim color (laminite only).

Left/Right Depth	Width	Number ①②③	HPL Edgeband (J)		HPL Knife Edge (F)		Wood Edgeband (K)		Wood Knife Edge (U)			
			A	B	A	B	A	B	A	B		
90° Wrap-Around												
18" (457mm)	36" (914mm)	WUCR-3636-	S	N33	\$ 985.78	\$1040.05	\$ 1354.37	\$1408.64	\$ 1787.29	\$ 1967.12	\$2222.11	\$ 2401.94
	42" (1067mm)	WUCR-4242-	S	N33	1131.22	1194.79	1522.37	1585.94	1982.83	2197.94	2468.83	2683.94
	48" (1219mm)	WUCR-4848-	S	N33	1276.66	1349.53	1690.37	1763.24	2178.37	2428.76	2715.55	2965.94
	54" (1372mm)	WUCR-5454-	S	N33	1422.10	1504.27	1858.37	1940.54	N/A	N/A	N/A	N/A
24" (610mm)	36" (914mm)	WUCR-3636-	S	N44	\$1073.18	\$ 1141.75	\$ 1450.67	\$ 1519.24	\$1903.87	\$ 2101.66	\$2338.69	\$2536.48
	42" (1067mm)	WUCR-4242-	S	N44	1218.62	1296.49	1618.67	1696.54	2099.41	2332.48	2585.41	2818.48
	48" (1219mm)	WUCR-4848-	S	N44	1364.06	1451.23	1786.67	1873.84	2294.95	2563.30	2832.13	3100.48
	54" (1372mm)	WUCR-5454-	S	N44	1509.50	1605.97	1954.67	2051.14	N/A	N/A	N/A	N/A
30" (762mm)	36" (914mm)	WUCR-3636-	S	N55	\$1160.58	\$1243.45	\$ 1546.97	\$1629.84	\$2020.45	\$2236.20	\$2455.27	\$ 2671.02
	42" (1067mm)	WUCR-4242-	S	N55	1306.02	1398.19	1714.97	1807.14	2215.99	2467.02	2701.99	2953.02
	48" (1219mm)	WUCR-4848-	S	N55	1451.46	1552.93	1882.97	1984.44	N/A	N/A	N/A	N/A
	54" (1372mm)	WUCR-5454-	S	N55	1596.90	1707.67	2050.97	2161.74	N/A	N/A	N/A	N/A
90° Wrap-Around Transitional												
18" (457mm)/24" (610mm)	36" (914mm)	WUCT-3636-	S	N34	\$1029.48	\$1090.90	\$ 1402.52	\$1463.94	\$ 1845.58	\$2034.39	\$2280.40	\$2469.21
	42" (1067mm)	WUCT-4242-	S	N34	1174.92	1245.64	1570.52	1641.24	2041.12	2265.21	2527.12	2761.21
	48" (1219mm)	WUCT-4848-	S	N34	1320.36	1400.38	1738.52	1818.54	2236.66	2496.03	2773.84	3033.21
	54" (1372mm)	WUCT-5454-	S	N34	1465.80	1555.12	1906.52	1995.84	N/A	N/A	N/A	N/A
24" (610mm)/18" (457mm)	36" (914mm)	WUCT-3636-	S	N43	\$1029.48	\$1090.90	\$ 1402.52	\$1463.94	\$ 1845.58	\$2034.39	\$2280.40	\$2469.21
	42" (1067mm)	WUCT-4242-	S	N43	1174.92	1245.64	1570.52	1641.24	2041.12	2265.21	2527.12	2761.21
	48" (1219mm)	WUCT-4848-	S	N43	1320.36	1400.38	1738.52	1818.54	2236.66	2496.03	2773.84	3033.21
	54" (1372mm)	WUCT-5454-	S	N43	1465.80	1555.12	1906.52	1995.84	N/A	N/A	N/A	N/A
24" (610mm)/30" (762mm)	36" (914mm)	WUCT-3636-	S	N45	\$ 1116.88	\$ 1192.60	\$ 1498.82	\$ 1574.54	\$ 1962.16	\$ 2168.93	\$2396.98	\$2603.75
	42" (1067mm)	WUCT-4242-	S	N45	1262.32	1347.34	1666.82	1751.84	2157.70	2399.75	2643.70	2885.75
	48" (1219mm)	WUCT-4848-	S	N45	1407.76	1502.08	1834.82	1929.14	N/A	N/A	N/A	N/A
	54" (1372mm)	WUCT-5454-	S	N45	1553.20	1656.82	2002.82	2106.44	N/A	N/A	N/A	N/A
30" (762mm)/24" (610mm)	36" (914mm)	WUCT-3636-	S	N54	\$ 1116.88	\$ 1192.60	\$ 1498.82	\$ 1574.54	\$ 1962.16	\$ 2168.93	\$2396.98	\$2603.75
	42" (1067mm)	WUCT-4242-	S	N54	1262.32	1347.34	1666.82	1751.84	2157.70	2399.75	2643.70	2885.75
	48" (1219mm)	WUCT-4848-	S	N54	1407.76	1502.08	1834.82	1929.14	N/A	N/A	N/A	N/A
	54" (1372mm)	WUCT-5454-	S	N54	1553.20	1656.82	2002.82	2106.44	N/A	N/A	N/A	N/A

Adaptable Worksurfaces — Corner

Wrap-Around Extended Corner – 90°

Wrap-Around Extended

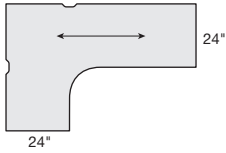
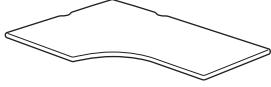

(Right-hand orientation)
WUCE-R44

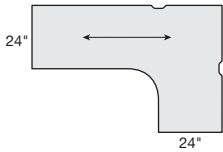

(Left-hand orientation)
WUCE-L44

Wrap-Around Extended Transitional

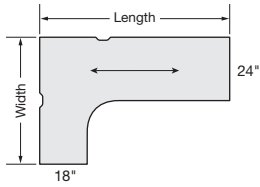

(Right-hand orientation)
WUCX-R34

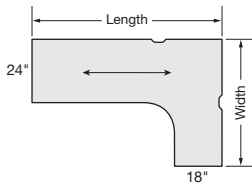

(Left-hand orientation)
WUCX-L43
Class CA

To Order, Specify:

1) Product number, including:

1 Surface Option:

- L** Laminate
- W** Wood

2 Edge Option:

Laminate:

- J** Edgeband
- F** Knife

Wood:

- K** Edgeband
- U** Knife

3 Wireway Option:

- A** Notched
- C** Without

4 Orientation (as seated):

- R** Right-hand
- L** Left-hand

2) Laminate color or Wood finish color.

3) Edge trim color (laminated only).

Adaptable Worksurfaces — Corner

Wrap-Around Extended Corner – 90°

Depth	Width	Length	Number	①	②	③	④	HPL Edgeband (J)		HPL Knife Edge (F)		Wood Edgeband (K)		Wood Knife Edge (U)	
								A	B	A	B	A	B	A	B
90° Wrap-Around Extended															
18"(457mm)	36"(914mm)	42"(1067mm)	WUCE-3642-	S	33	\$ 1381.48	\$ 1464.66	\$ 1901.65	\$ 1984.83	\$ 2245.88	\$ 2400.67	\$ 2880.34	\$ 3035.13		
		48"(1219mm)	WUCE-3648-	S	33	1399.62	1483.81	1938.35	2022.54	2264.79	2423.00	2921.68	3079.89		
		54"(1372mm)	WUCE-3654-	S	33	1417.76	1502.96	1975.05	2060.25	2283.70	2445.33	2963.02	3124.65		
		60"(1524mm)	WUCE-3660-	S	33	1435.90	1522.11	2011.75	2097.96	2302.61	2467.66	3004.36	3169.41		
		66"(1676mm)	WUCE-3666-	S	33	1587.68	1674.90	2182.09	2269.31	2538.25	2706.72	3262.43	3430.90		
24"(610mm)	36"(914mm)	42"(1067mm)	WUCE-3642-	S	44	\$ 1432.80	\$ 1520.10	\$ 1952.97	\$ 2040.27	\$ 2293.32	\$ 2456.75	\$ 2927.78	\$ 3091.21		
		48"(1219mm)	WUCE-3648-	S	44	1450.94	1539.25	1989.67	2077.98	2312.23	2479.08	2969.12	3135.97		
		54"(1372mm)	WUCE-3654-	S	44	1469.08	1558.40	2026.37	2115.69	2331.14	2501.41	3010.46	3180.73		
		60"(1524mm)	WUCE-3660-	S	44	1487.22	1577.55	2063.07	2153.40	2350.05	2523.74	3051.80	3225.49		
		66"(1676mm)	WUCE-3666-	S	44	1639.00	1730.34	2233.41	2324.75	2585.69	2762.80	3309.87	3486.98		
30"(762mm)	36"(914mm)	42"(1067mm)	WUCE-3642-	S	55	\$ 1700.80	\$ 1792.22	\$ 2220.97	\$ 2312.39	\$ 2557.44	\$ 2729.51	\$ 3191.90	\$ 3363.97		
		48"(1219mm)	WUCE-3648-	S	55	1718.94	1811.37	2257.67	2350.10	2576.35	2751.84	3233.24	3408.73		
		54"(1372mm)	WUCE-3654-	S	55	1737.08	1830.52	2294.37	2387.81	2595.26	2774.17	3274.58	3453.49		
		60"(1524mm)	WUCE-3660-	S	55	1755.22	1849.67	2331.07	2425.52	2614.17	2796.50	3315.92	3498.25		
		66"(1676mm)	WUCE-3666-	S	55	1907.00	2002.46	2501.41	2596.87	2849.81	3035.56	3573.99	3759.74		
18"(457mm)	42"(1067mm)	48"(1219mm)	WUCE-4248-	S	33	\$ 1417.76	\$ 1502.96	\$ 1975.05	\$ 2060.25	\$ 2283.70	\$ 2445.33	\$ 2963.02	\$ 3124.65		
		54"(1372mm)	WUCE-4254-	S	33	1435.90	1522.11	2011.75	2097.96	2302.61	2467.66	3004.36	3169.41		
		60"(1524mm)	WUCE-4260-	S	33	1454.04	1541.26	2048.45	2135.67	2321.52	2489.99	3045.70	3214.17		
		66"(1676mm)	WUCE-4266-	S	33	1639.23	1727.46	2252.20	2340.43	2557.16	2729.05	3303.77	3475.66		
		72"(1829mm)	WUCE-4272-	S	33	1768.16	1857.40	2399.69	2488.93	2798.54	2973.85	3567.58	3742.89		
24"(610mm)	42"(1067mm)	48"(1219mm)	WUCE-4248-	S	44	\$ 1469.08	\$ 1558.40	\$ 2026.37	\$ 2115.69	\$ 2331.14	\$ 2501.41	\$ 3010.46	\$ 3180.73		
		54"(1372mm)	WUCE-4254-	S	44	1487.22	1577.55	2063.07	2153.40	2350.05	2523.74	3051.80	3225.49		
		60"(1524mm)	WUCE-4260-	S	44	1505.36	1596.70	2099.77	2191.11	2368.96	2546.07	3093.14	3270.25		
		66"(1676mm)	WUCE-4266-	S	44	1690.55	1782.90	2303.52	2395.87	2604.60	2785.13	3351.21	3531.74		
		72"(1829mm)	WUCE-4272-	S	44	1819.48	1912.84	2451.01	2544.37	2845.98	3029.93	3615.02	3798.97		
30"(762mm)	42"(1067mm)	48"(1219mm)	WUCE-4248-	S	55	\$ 1737.08	\$ 1830.52	\$ 2294.37	\$ 2387.81	\$ 2595.26	\$ 2774.17	\$ 3274.58	\$ 3453.49		
		54"(1372mm)	WUCE-4254-	S	55	1755.22	1849.67	2331.07	2425.52	2614.17	2796.50	3315.92	3498.25		
		60"(1524mm)	WUCE-4260-	S	55	1773.36	1868.82	2367.77	2463.23	2633.08	2818.83	3357.26	3543.01		
		66"(1676mm)	WUCE-4266-	S	55	1958.55	2055.02	2571.52	2667.99	2868.72	3057.89	3615.33	3804.50		
		72"(1829mm)	WUCE-4272-	S	55	2087.48	2184.96	2719.01	2816.49	3110.10	3302.69	3879.14	4071.73		
18"(457mm)	48"(1219mm)	54"(1372mm)	WUCE-4854-	S	33	\$ 1454.04	\$ 1541.26	\$ 2048.45	\$ 2135.67	\$ 2321.52	\$ 2489.99	\$ 3045.70	\$ 3214.17		
		60"(1524mm)	WUCE-4860-	S	33	1472.18	1560.41	2085.15	2173.38	2340.43	2512.32	3087.04	3258.93		
		66"(1676mm)	WUCE-4866-	S	33	1690.78	1780.02	2322.31	2411.55	2576.07	2751.38	3345.11	3520.42		
		72"(1829mm)	WUCE-4872-	S	33	1819.71	1909.96	2469.80	2560.05	2817.45	2996.18	3608.92	3787.65		
		24"(610mm)	48"(1219mm)	54"(1372mm)	WUCE-4854-	S	44	\$ 1505.36	\$ 1596.70	\$ 2099.77	\$ 2191.11	\$ 2368.96	\$ 2546.07	\$ 3093.14	\$ 3270.25
30"(762mm)	48"(1219mm)	54"(1372mm)	WUCE-4854-	S	55	\$ 1773.36	\$ 1868.82	\$ 2367.77	\$ 2463.23	\$ 2633.08	\$ 2818.83	\$ 3357.26	\$ 3543.01		
		60"(1524mm)	WUCE-4860-	S	55	1791.50	1887.97	2404.47	2500.94	2651.99	2841.16	3398.60	3587.77		
		66"(1676mm)	WUCE-4866-	S	55	2010.10	2107.58	2641.63	2739.11	2887.63	3080.22	3656.67	3849.26		
		72"(1829mm)	WUCE-4872-	S	55	2139.03	2237.52	2789.12	2887.61	3129.01	3325.02	3920.48	4116.49		
		18"(457mm)	54"(1372mm)	60"(1524mm)	WUCE-5460-	S	33	\$ 1490.32	\$ 1579.56	\$ 2121.85	\$ 2211.09	N/A	N/A	N/A	N/A
24"(610mm)	54"(1372mm)	66"(1676mm)	WUCE-5466-	S	33	1742.33	1832.58	2392.42	2482.67	N/A	N/A	N/A	N/A		
		72"(1829mm)	WUCE-5472-	S	33	1871.26	1962.52	2539.91	2631.17	N/A	N/A	N/A	N/A		
		60"(1524mm)	WUCE-5460-	S	44	\$ 1541.64	\$ 1635.00	\$ 2173.17	\$ 2266.53	N/A	N/A	N/A	N/A		
30"(762mm)	54"(1372mm)	66"(1676mm)	WUCE-5466-	S	44	1793.65	1888.02	2443.74	2538.11	N/A	N/A	N/A	N/A		
		72"(1829mm)	WUCE-5472-	S	44	1922.58	2017.96	2591.23	2686.61	N/A	N/A	N/A	N/A		
		60"(1524mm)	WUCE-5460-	S	55	\$ 1809.64	\$ 1907.12	\$ 2441.17	\$ 2538.65	N/A	N/A	N/A	N/A		
18"(457mm)	60"(1524mm)	66"(1676mm)	WUCE-6066-	S	33	\$ 1793.88	\$ 1885.14	\$ 2462.53	\$ 2553.79	N/A	N/A	N/A	N/A		
		72"(1829mm)	WUCE-6072-	S	33	1922.81	2015.08	2610.02	2702.29	N/A	N/A	N/A	N/A		
		66"(1676mm)	WUCE-6066-	S	44	\$ 1845.20	\$ 1940.58	\$ 2513.85	\$ 2609.23	N/A	N/A	N/A	N/A		
24"(610mm)	60"(1524mm)	72"(1829mm)	WUCE-6072-	S	44	1974.13	2070.52	2661.34	2757.73	N/A	N/A	N/A	N/A		
		66"(1676mm)	WUCE-6066-	S	55	\$ 2113.20	\$ 2212.70	\$ 2781.85	\$ 2881.35	N/A	N/A	N/A	N/A		
30"(762mm)	60"(1524mm)	72"(1829mm)	WUCE-6072-	S	55	2242.13	2342.64	2929.34	3029.85	N/A	N/A	N/A	N/A		

Adaptable Worksurfaces — Corner

Wrap-Around Extended Corner – 90°

Left/Right Depth	Width	Length	Number ①② ③④	HPL Edgeband (J)		HPL Knife Edge (F)		Wood Edgeband (K)		Wood Knife Edge (U)			
				A	B	A	B	A	B	A	B		
90° Wrap-Around Transitional Extended													
18"(457mm)/24"(610mm)	36"(914mm)	42"(1067mm)	WUCX-3642-	S	34	\$1558.05	\$1643.29	\$2078.22	\$2163.46	\$2521.11	\$2680.22	\$3155.57	\$3314.68
		48"(1219mm)	WUCX-3648-	S	34	1576.19	1662.44	2114.92	2201.17	2540.02	2702.55	3196.91	3359.44
		54"(1372mm)	WUCX-3654-	S	34	1594.33	1681.59	2151.62	2238.88	2558.93	2724.88	3238.25	3404.20
		60"(1524mm)	WUCX-3660-	S	34	1612.47	1700.74	2188.32	2276.59	2577.84	2747.21	3279.59	3448.96
		66"(1676mm)	WUCX-3666-	S	34	1764.25	1853.53	2358.66	2447.94	2813.48	2986.27	3537.66	3710.45
		72"(1829mm)	WUCX-3672-	S	34	1893.18	1983.47	2506.15	2596.44	3054.86	3231.07	3801.47	3977.68
24"(610mm)/18"(457mm)	36"(914mm)	42"(1067mm)	WUCX-3642-	S	43	\$1558.05	\$1643.29	\$2078.22	\$2163.46	\$2521.11	\$2680.22	\$3155.57	\$3314.68
		48"(1219mm)	WUCX-3648-	S	43	1576.19	1662.44	2114.92	2201.17	2540.02	2702.55	3196.91	3359.44
		54"(1372mm)	WUCX-3654-	S	43	1594.33	1681.59	2151.62	2238.88	2558.93	2724.88	3238.25	3404.20
		60"(1524mm)	WUCX-3660-	S	43	1612.47	1700.74	2188.32	2276.59	2577.84	2747.21	3279.59	3448.96
		66"(1676mm)	WUCX-3666-	S	43	1764.25	1853.53	2358.66	2447.94	2813.48	2986.27	3537.66	3710.45
		72"(1829mm)	WUCX-3672-	S	43	1893.18	1983.47	2506.15	2596.44	3054.86	3231.07	3801.47	3977.68
24"(610mm)/30"(762mm)	36"(914mm)	42"(1067mm)	WUCX-3642-	S	45	\$1609.37	\$1698.73	\$2129.54	\$2218.90	\$2568.55	\$2736.30	\$3203.01	\$3370.76
		48"(1219mm)	WUCX-3648-	S	45	1627.51	1717.88	2166.24	2256.61	2587.46	2758.63	3244.35	3415.52
		54"(1372mm)	WUCX-3654-	S	45	1645.65	1737.03	2202.94	2294.32	2606.37	2780.96	3285.69	3460.28
		60"(1524mm)	WUCX-3660-	S	45	1663.79	1756.18	2239.64	2332.03	2625.28	2803.29	3327.03	3505.04
		66"(1676mm)	WUCX-3666-	S	45	1815.57	1908.97	2409.98	2503.38	2860.92	3042.35	3585.10	3766.53
		72"(1829mm)	WUCX-3672-	S	45	1944.50	2038.91	2557.47	2651.88	3102.30	3287.15	3848.91	4033.76
30"(762mm)/24"(610mm)	36"(914mm)	42"(1067mm)	WUCX-3642-	S	54	\$1609.37	\$1698.73	\$2129.54	\$2218.90	\$2568.55	\$2736.30	\$3203.01	\$3370.76
		48"(1219mm)	WUCX-3648-	S	54	1627.51	1717.88	2166.24	2256.61	2587.46	2758.63	3244.35	3415.52
		54"(1372mm)	WUCX-3654-	S	54	1645.65	1737.03	2202.94	2294.32	2606.37	2780.96	3285.69	3460.28
		60"(1524mm)	WUCX-3660-	S	54	1663.79	1756.18	2239.64	2332.03	2625.28	2803.29	3327.03	3505.04
		66"(1676mm)	WUCX-3666-	S	54	1815.57	1908.97	2409.98	2503.38	2860.92	3042.35	3585.10	3766.53
		72"(1829mm)	WUCX-3672-	S	54	1944.50	2038.91	2557.47	2651.88	3102.30	3287.15	3848.91	4033.76
18"(457mm)/24"(610mm)	42"(1067mm)	48"(1219mm)	WUCX-4248-	S	34	\$1594.33	\$1681.59	\$2151.62	\$2238.88	\$2558.93	\$2724.88	\$3238.25	\$3404.20
		54"(1372mm)	WUCX-4254-	S	34	1612.47	1700.74	2188.32	2276.59	2577.84	2747.21	3279.59	3448.96
		60"(1524mm)	WUCX-4260-	S	34	1630.61	1719.89	2225.02	2314.30	2596.75	2769.54	3320.93	3493.72
		66"(1676mm)	WUCX-4266-	S	34	1815.80	1906.09	2428.77	2519.06	2832.39	3008.60	3579.00	3755.21
		72"(1829mm)	WUCX-4272-	S	34	1944.73	2036.03	2576.26	2667.56	3073.77	3253.40	3842.81	4022.44
		24"(610mm)/18"(457mm)	42"(1067mm)	48"(1219mm)	WUCX-4248-	S	43	\$1594.33	\$1681.59	\$2151.62	\$2238.88	\$2558.93	\$2724.88
54"(1372mm)	WUCX-4254-			S	43	1612.47	1700.74	2188.32	2276.59	2577.84	2747.21	3279.59	3448.96
60"(1524mm)	WUCX-4260-			S	43	1630.61	1719.89	2225.02	2314.30	2596.75	2769.54	3320.93	3493.72
66"(1676mm)	WUCX-4266-			S	43	1815.80	1906.09	2428.77	2519.06	2832.39	3008.60	3579.00	3755.21
72"(1829mm)	WUCX-4272-			S	43	1944.73	2036.03	2576.26	2667.56	3073.77	3253.40	3842.81	4022.44
24"(610mm)/30"(762mm)	42"(1067mm)			48"(1219mm)	WUCX-4248-	S	45	\$1645.65	\$1737.03	\$2202.94	\$2294.32	\$2606.37	\$2780.96
		54"(1372mm)	WUCX-4254-	S	45	1663.79	1756.18	2239.64	2332.03	2625.28	2803.29	3327.03	3505.04
		60"(1524mm)	WUCX-4260-	S	45	1681.93	1775.33	2276.34	2369.74	2644.19	2825.62	3368.37	3549.80
		66"(1676mm)	WUCX-4266-	S	45	1867.12	1961.53	2480.09	2574.50	2879.83	3064.68	3626.44	3811.29
		72"(1829mm)	WUCX-4272-	S	45	1996.05	2091.47	2627.58	2723.00	3121.21	3309.48	3890.25	4078.52
		30"(762mm)/24"(610mm)	42"(1067mm)	48"(1219mm)	WUCX-4248-	S	54	\$1645.65	\$1737.03	\$2202.94	\$2294.32	\$2606.37	\$2780.96
54"(1372mm)	WUCX-4254-			S	54	1663.79	1756.18	2239.64	2332.03	2625.28	2803.29	3327.03	3505.04
60"(1524mm)	WUCX-4260-			S	54	1681.93	1775.33	2276.34	2369.74	2644.19	2825.62	3368.37	3549.80
66"(1676mm)	WUCX-4266-			S	54	1867.12	1961.53	2480.09	2574.50	2879.83	3064.68	3626.44	3811.29
72"(1829mm)	WUCX-4272-			S	54	1996.05	2091.47	2627.58	2723.00	3121.21	3309.48	3890.25	4078.52

Adaptable Worksurfaces — Corner

Wrap-Around Extended Corner – 90°

Left/Right Depth	Width	Length	Number ①② ③④	HPL Edgeband (J)		HPL Knife Edge (F)		Wood Edgeband (K)		Wood Knife Edge (U)			
				A	B	A	B	A	B	A	B		
18"(457mm)/24"(610mm)	48"(1219mm)	54"(1372mm)	WUCX-4854-	S	34	\$ 1630.61	\$ 1719.89	\$ 2225.02	\$ 2314.30	\$ 2596.75	\$ 2769.54	\$ 3320.93	\$ 3493.72
		60"(1524mm)	WUCX-4860-	S	34	1648.75	1739.04	2261.72	2352.01	2615.66	2791.87	3362.27	3538.48
		66"(1676mm)	WUCX-4866-	S	34	1867.35	1958.65	2498.88	2590.18	2851.30	3030.93	3620.34	3799.97
		72"(1829mm)	WUCX-4872-	S	34	1996.28	2088.59	2646.37	2738.68	3092.68	3275.73	3884.15	4067.20
24"(610mm)/18"(457mm)	48"(1219mm)	54"(1372mm)	WUCX-4854-	S	43	\$ 1630.61	\$ 1719.89	\$ 2225.02	\$ 2314.30	\$ 2596.75	\$ 2769.54	\$ 3320.93	\$ 3493.72
		60"(1524mm)	WUCX-4860-	S	43	1648.75	1739.04	2261.72	2352.01	2615.66	2791.87	3362.27	3538.48
		66"(1676mm)	WUCX-4866-	S	43	1867.35	1958.65	2498.88	2590.18	2851.30	3030.93	3620.34	3799.97
		72"(1829mm)	WUCX-4872-	S	43	1996.28	2088.59	2646.37	2738.68	3092.68	3275.73	3884.15	4067.20
24"(610mm)/30"(762mm)	48"(1219mm)	54"(1372mm)	WUCX-4854-	S	45	\$ 1681.93	\$ 1775.33	\$ 2276.34	\$ 2369.74	\$ 2644.19	\$ 2825.62	\$ 3368.37	\$ 3549.80
		60"(1524mm)	WUCX-4860-	S	45	1700.07	1794.48	2313.04	2407.45	2663.10	2847.95	3409.71	3594.56
		66"(1676mm)	WUCX-4866-	S	45	1918.67	2014.09	2550.20	2645.62	2898.74	3087.01	3667.78	3856.05
		72"(1829mm)	WUCX-4872-	S	45	2047.60	2144.03	2697.69	2794.12	3140.12	3331.81	3931.59	4123.28
30"(762mm)/24"(610mm)	48"(1219mm)	54"(1372mm)	WUCX-4854-	S	54	\$ 1681.93	\$ 1775.33	\$ 2276.34	\$ 2369.74	\$ 2644.19	\$ 2825.62	\$ 3368.37	\$ 3549.80
		60"(1524mm)	WUCX-4860-	S	54	1700.07	1794.48	2313.04	2407.45	2663.10	2847.95	3409.71	3594.56
		66"(1676mm)	WUCX-4866-	S	54	1918.67	2014.09	2550.20	2645.62	2898.74	3087.01	3667.78	3856.05
		72"(1829mm)	WUCX-4872-	S	54	2047.60	2144.03	2697.69	2794.12	3140.12	3331.81	3931.59	4123.28
18"(457mm)/24"(610mm)	54"(1372mm)	60"(1524mm)	WUCX-5460-	S	34	\$ 1666.89	\$ 1758.19	\$ 2298.42	\$ 2389.72	N/A	N/A	N/A	N/A
		66"(1676mm)	WUCX-5466-	S	34	1918.90	2011.21	2568.99	2661.30	N/A	N/A	N/A	N/A
		72"(1829mm)	WUCX-5472-	S	34	2047.83	2141.15	2716.48	2809.80	N/A	N/A	N/A	N/A
24"(610mm)/18"(457mm)	54"(1372mm)	60"(1524mm)	WUCX-5460-	S	43	\$ 1666.89	\$ 1758.19	\$ 2298.42	\$ 2389.72	N/A	N/A	N/A	N/A
		66"(1676mm)	WUCX-5466-	S	43	1918.90	2011.21	2568.99	2661.30	N/A	N/A	N/A	N/A
		72"(1829mm)	WUCX-5472-	S	43	2047.83	2141.15	2716.48	2809.80	N/A	N/A	N/A	N/A
24"(610mm)/30"(762mm)	54"(1372mm)	60"(1524mm)	WUCX-5460-	S	45	\$ 1718.21	\$ 1813.63	\$ 2349.74	\$ 2445.16	N/A	N/A	N/A	N/A
		66"(1676mm)	WUCX-5466-	S	45	1970.22	2066.65	2620.31	2716.74	N/A	N/A	N/A	N/A
		72"(1829mm)	WUCX-5472-	S	45	2099.15	2196.59	2767.80	2865.24	N/A	N/A	N/A	N/A
30"(762mm)/24"(610mm)	54"(1372mm)	60"(1524mm)	WUCX-5460-	S	54	\$ 1718.21	\$ 1813.63	\$ 2349.74	\$ 2445.16	N/A	N/A	N/A	N/A
		66"(1676mm)	WUCX-5466-	S	54	1970.22	2066.65	2620.31	2716.74	N/A	N/A	N/A	N/A
		72"(1829mm)	WUCX-5472-	S	54	2099.15	2196.59	2767.80	2865.24	N/A	N/A	N/A	N/A
18"(457mm)/24"(610mm)	60"(1524mm)	66"(1676mm)	WUCX-6066-	S	34	\$ 1970.45	\$ 2063.77	\$ 2639.10	\$ 2732.42	N/A	N/A	N/A	N/A
		72"(1829mm)	WUCX-6072-	S	34	2099.38	2193.71	2786.59	2880.92	N/A	N/A	N/A	N/A
24"(610mm)/18"(457mm)	60"(1524mm)	66"(1676mm)	WUCX-6066-	S	43	\$ 1970.45	\$ 2063.77	\$ 2639.10	\$ 2732.42	N/A	N/A	N/A	N/A
		72"(1829mm)	WUCX-6072-	S	43	2099.38	2193.71	2786.59	2880.92	N/A	N/A	N/A	N/A
24"(610mm)/30"(762mm)	60"(1524mm)	66"(1676mm)	WUCX-6066-	S	45	\$ 2021.77	\$ 2119.21	\$ 2690.42	\$ 2787.86	N/A	N/A	N/A	N/A
		72"(1829mm)	WUCX-6072-	S	45	2150.70	2249.15	2837.91	2936.36	N/A	N/A	N/A	N/A
30"(762mm)/24"(610mm)	60"(1524mm)	66"(1676mm)	WUCX-6066-	S	54	\$ 2021.77	\$ 2119.21	\$ 2690.42	\$ 2787.86	N/A	N/A	N/A	N/A
		72"(1829mm)	WUCX-6072-	S	54	2150.70	2249.15	2837.91	2936.36	N/A	N/A	N/A	N/A

Adaptable Worksurfaces — Corner

Notched Corner – 90°

Notched

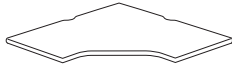

WUCN

Notched Transitional

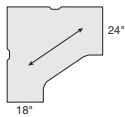

WUCH-N34

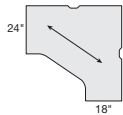

WUCH-N43

Class CA

To Order, Specify:

1) Product number, including:

1 Surface Option:

L Laminate

W Wood

2 Edge Option:

Laminate:

J Edgeband

F Knife

Wood:

K Edgeband

U Knife

3 Wireway Option:

A Notched

C Without

2) Laminate color or Wood finish color.

3) Edge trim color (laminite only).

Left/Right Depth	Width	Number ①②③	HPL Edgeband (J)		HPL Knife Edge (F)		Wood Edgeband (K)		Wood Knife Edge (U)			
			A	B	A	B	A	B	A	B		
Notched												
18"(457mm)	36"(914mm)	WUCN-3636-	S	N33	\$1064.31	\$ 119.84	\$ 1435.11	\$1490.64	\$1544.31	\$1586.89	\$ 1979.57	\$2022.15
	42"(1067mm)	WUCN-4242-	S	N33	1195.78	1262.41	1605.98	1672.61	1744.23	1792.33	2225.64	2273.74
	48"(1219mm)	WUCN-4848-	S	N33	1329.10	1406.83	1786.58	1864.31	1944.15	1997.77	2480.94	2534.56
	54"(1372mm)	WUCN-5454-	S	N33	1506.86	1595.69	2011.62	2100.45	N/A	N/A	N/A	N/A
24"(610mm)	36"(914mm)	WUCN-3636-	S	N44	\$1093.92	\$ 1149.45	\$ 1464.72	\$1620.25	\$1573.92	\$ 1616.50	\$2009.18	\$ 2051.76
	42"(1067mm)	WUCN-4242-	S	N44	1225.39	1292.02	1635.59	1702.22	1773.84	1821.94	2255.25	2303.35
	48"(1219mm)	WUCN-4848-	S	N44	1358.71	1436.44	1816.19	1893.92	1973.76	2027.38	2510.55	2564.17
	54"(1372mm)	WUCN-5454-	S	N44	1536.47	1625.30	2041.23	2130.06	N/A	N/A	N/A	N/A
30"(762mm)	36"(914mm)	WUCN-3636-	S	N55	\$ 1123.54	\$ 1179.07	\$ 1494.34	\$1549.87	\$1603.54	\$1646.12	\$2038.80	\$ 2081.38
	42"(1067mm)	WUCN-4242-	S	N55	1255.01	1321.64	1665.21	1731.84	1803.46	1851.56	2284.87	2332.97
	48"(1219mm)	WUCN-4848-	S	N55	1388.33	1466.06	1845.81	1923.54	N/A	N/A	N/A	N/A
	54"(1372mm)	WUCN-5454-	S	N55	1566.09	1654.92	2070.85	2159.68	N/A	N/A	N/A	N/A
Notched Transitional												
18"(457mm)/24"(610mm)	36"(914mm)	WUCH-3636-	S	N34	\$1045.82	\$ 1101.35	\$ 1416.62	\$1472.15	\$1625.82	\$1668.40	\$ 1961.08	\$2003.66
	42"(1067mm)	WUCH-4242-	S	N34	1177.29	1243.92	1587.49	1654.12	1725.74	1773.84	2207.15	2255.25
	48"(1219mm)	WUCH-4848-	S	N34	1310.61	1388.34	1768.09	1845.82	1925.66	1979.28	2462.45	2516.07
	54"(1372mm)	WUCH-5454-	S	N34	1488.37	1577.20	1993.13	2081.96	N/A	N/A	N/A	N/A
24"(610mm)/18"(457mm)	36"(914mm)	WUCH-3636-	S	N43	\$1045.82	\$ 1101.35	\$ 1416.62	\$1472.15	\$1525.82	\$1568.40	\$ 1961.08	\$2003.66
	42"(1067mm)	WUCH-4242-	S	N43	1177.29	1243.92	1587.49	1654.12	1725.74	1773.84	2207.15	2255.25
	48"(1219mm)	WUCH-4848-	S	N43	1310.61	1388.34	1768.09	1845.82	1925.66	1979.28	2462.45	2516.07
	54"(1372mm)	WUCH-5454-	S	N43	1488.37	1577.20	1993.13	2081.96	N/A	N/A	N/A	N/A
24"(610mm)/30"(762mm)	36"(914mm)	WUCH-3636-	S	N45	\$ 1105.05	\$ 1160.58	\$ 1475.85	\$ 1531.38	\$1585.05	\$ 1627.63	\$2020.31	\$2062.89
	42"(1067mm)	WUCH-4242-	S	N45	1236.52	1303.15	1646.72	1713.35	1784.97	1833.07	2266.38	2314.48
	48"(1219mm)	WUCH-4848-	S	N45	1369.84	1447.57	1827.32	1905.05	N/A	N/A	N/A	N/A
	54"(1372mm)	WUCH-5454-	S	N45	1547.60	1636.43	2052.36	2141.19	N/A	N/A	N/A	N/A
30"(762mm)/24"(610mm)	36"(914mm)	WUCH-3636-	S	N54	\$ 1105.05	\$ 1160.58	\$ 1475.85	\$ 1531.38	\$1585.05	\$ 1627.63	\$2020.31	\$2062.89
	42"(1067mm)	WUCH-4242-	S	N54	1236.52	1303.15	1646.72	1713.35	1784.97	1833.07	2266.38	2314.48
	48"(1219mm)	WUCH-4848-	S	N54	1369.84	1447.57	1827.32	1905.05	N/A	N/A	N/A	N/A
	54"(1372mm)	WUCH-5454-	S	N54	1547.60	1636.43	2052.36	2141.19	N/A	N/A	N/A	N/A

Adaptable Worksurfaces — Corner

Notch Extended Corner – 90°

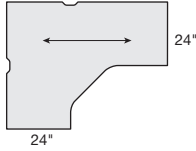
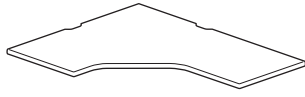

(Right-hand orientation)
WUCP-R44

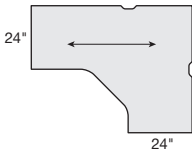

(Left-hand orientation)
WUCP-L44
Class CA

To Order, Specify:

1) Product number, including:

1 Surface Option:

- L** Laminate
- W** Wood

2 Edge Option:

- Laminate:
- J** Edgeband
 - F** Knife

- Wood:
- K** Edgeband
 - U** Knife

3 Wireway/Cutout Option:

- A** Notched
- C** Without

4 Orientation (as seated):

- R** Right-hand
- L** Left-hand

2) Laminate color or Wood finish color.

3) Edge trim color (laminite only).

Depth	Width	Length	Number	HPL Edgeband (J)		HPL Knife Edge (F)		Wood Edgeband (K)		Wood Knife Edge (U)			
				1	2	3	4	A	B	A	B	A	B
18"(457mm)	36"(914mm)	42"(1067mm)	WUCP-3642-	S	33	\$ 1491.24	\$ 1587.53	\$2009.43	\$ 2105.72	\$ 2178.38	\$ 2323.74	\$2808.10	\$2953.46
		48"(1219mm)	WUCP-3648-	S	33	1529.00	1627.84	2065.86	2164.70	2245.41	2402.68	2903.88	3061.15
		54"(1372mm)	WUCP-3654-	S	33	1566.76	1668.15	2122.29	2223.68	2312.44	2481.62	2999.66	3168.84
		60"(1524mm)	WUCP-3660-	S	33	1604.52	1708.46	2178.72	2282.66	2379.47	2560.56	3095.44	3276.53
		66"(1676mm)	WUCP-3666-	S	33	1642.28	1748.77	2235.15	2341.64	2446.50	2639.50	3191.22	3384.22
		72"(1829mm)	WUCP-3672-	S	33	1885.81	1994.85	2497.35	2606.39	2719.30	2924.21	3492.77	3697.68
24"(610mm)	36"(914mm)	42"(1067mm)	WUCP-3642-	S	44	\$ 1533.89	\$ 1633.61	\$2052.08	\$ 2151.80	\$ 2212.26	\$2363.63	\$ 2841.98	\$2993.35
		48"(1219mm)	WUCP-3648-	S	44	1571.65	1673.92	2108.51	2210.78	2279.29	2442.57	2937.76	3101.04
		54"(1372mm)	WUCP-3654-	S	44	1609.41	1714.23	2164.94	2269.76	2346.32	2521.51	3033.54	3208.73
		60"(1524mm)	WUCP-3660-	S	44	1647.17	1754.54	2221.37	2328.74	2413.35	2600.45	3129.32	3316.42
		66"(1676mm)	WUCP-3666-	S	44	1684.93	1794.85	2277.80	2387.72	2480.38	2679.39	3225.10	3424.11
		72"(1829mm)	WUCP-3672-	S	44	1928.46	2040.93	2540.00	2652.47	2753.18	2964.10	3526.65	3737.57
30"(762mm)	36"(914mm)	42"(1067mm)	WUCP-3642-	S	55	\$ 1576.54	\$ 1679.69	\$2094.73	\$ 2197.88	\$2246.14	\$2403.52	\$ 2875.86	\$3033.24
		48"(1219mm)	WUCP-3648-	S	55	1614.30	1720.00	2151.16	2256.86	2313.17	2482.46	2971.64	3140.93
		54"(1372mm)	WUCP-3654-	S	55	1652.06	1760.31	2207.59	2315.84	2380.20	2561.40	3067.42	3248.62
		60"(1524mm)	WUCP-3660-	S	55	1689.82	1800.62	2264.02	2374.82	2447.23	2640.34	3163.20	3356.31
		66"(1676mm)	WUCP-3666-	S	55	1727.58	1840.93	2320.45	2433.80	2514.26	2719.28	3258.98	3464.00
		72"(1829mm)	WUCP-3672-	S	55	1971.11	2087.01	2582.65	2698.55	2787.06	3003.99	3560.53	3777.46
18"(457mm)	42"(1067mm)	48"(1219mm)	WUCP-4248-	S	33	\$ 1566.76	\$ 1668.15	\$ 2122.29	\$ 2223.68	\$ 2312.44	\$ 2481.62	\$2999.66	\$ 3168.84
		54"(1372mm)	WUCP-4254-	S	33	1604.52	1708.46	2178.72	2282.66	2379.47	2560.56	3095.44	3276.53
		60"(1524mm)	WUCP-4260-	S	33	1642.28	1748.77	2235.15	2341.64	2446.50	2639.50	3191.22	3384.22
		66"(1676mm)	WUCP-4266-	S	33	1680.04	1789.08	2291.58	2400.62	2513.53	2718.44	3287.00	3491.91
		72"(1829mm)	WUCP-4272-	S	33	1923.57	2035.16	2553.78	2665.37	2786.33	3003.15	3588.55	3805.37
		24"(610mm)	42"(1067mm)	48"(1219mm)	WUCP-4248-	S	44	\$ 1609.41	\$ 1714.23	\$ 2164.94	\$ 2269.76	\$2346.32	\$ 2521.51
54"(1372mm)	WUCP-4254-			S	44	1647.17	1754.54	2221.37	2328.74	2413.35	2600.45	3129.32	3316.42
60"(1524mm)	WUCP-4260-			S	44	1684.93	1794.85	2277.80	2387.72	2480.38	2679.39	3225.10	3424.11
66"(1676mm)	WUCP-4266-			S	44	1722.69	1835.16	2334.23	2446.70	2547.41	2758.33	3320.88	3531.80
72"(1829mm)	WUCP-4272-			S	44	1966.22	2081.24	2596.43	2711.45	2820.21	3043.04	3622.43	3845.26
30"(762mm)	42"(1067mm)			48"(1219mm)	WUCP-4248-	S	55	\$ 1652.06	\$ 1760.31	\$ 2207.59	\$ 2315.84	\$2380.20	\$ 2561.40
		54"(1372mm)	WUCP-4254-	S	55	1689.82	1800.62	2264.02	2374.82	2447.23	2640.34	3163.20	3356.31
		60"(1524mm)	WUCP-4260-	S	55	1727.58	1840.93	2320.45	2433.80	2514.26	2719.28	3258.98	3464.00
		66"(1676mm)	WUCP-4266-	S	55	1765.34	1881.24	2376.88	2492.78	2581.29	2798.22	3354.76	3571.69
		72"(1829mm)	WUCP-4272-	S	55	2008.87	2127.32	2639.08	2757.53	2854.09	3082.93	3656.31	3885.15

Adaptable Worksurfaces — Corner

Notch Extended Corner – 90°

Depth	Width	Length	Number 1 2 3 4	HPL Edgeband (J)		HPL Knife Edge (F)		Wood Edgeband (K)		Wood Knife Edge (U)	
				A	B	A	B	A	B	A	B
18"(457mm)	48"(1219mm)	54"(1372mm)	WUCP-4854- S 33	\$ 1642.28	\$ 1748.77	\$ 2235.15	\$ 2341.64	\$2446.50	\$2639.50	\$ 3191.22	\$3384.22
		60"(1524mm)	WUCP-4860- S 33	1680.04	1789.08	2291.58	2400.62	2513.53	2718.44	3287.00	3491.91
		66"(1676mm)	WUCP-4866- S 33	1717.80	1829.39	2348.01	2459.60	2580.56	2797.38	3382.78	3599.60
		72"(1829mm)	WUCP-4872- S 33	1961.33	2075.47	2610.21	2724.35	2853.36	3082.09	3684.33	3913.06
24"(610mm)	48"(1219mm)	54"(1372mm)	WUCP-4854- S 44	\$ 1684.93	\$ 1794.85	\$ 2277.80	\$ 2387.72	\$2480.38	\$ 2679.39	\$ 3225.10	\$3424.11
		60"(1524mm)	WUCP-4860- S 44	1722.69	1835.16	2334.23	2446.70	2547.41	2758.33	3320.88	3531.80
		66"(1676mm)	WUCP-4866- S 44	1760.45	1875.47	2390.66	2505.68	2614.44	2837.27	3416.66	3639.49
		72"(1829mm)	WUCP-4872- S 44	2003.98	2121.55	2652.86	2770.43	2887.24	3121.98	3718.21	3952.95
30"(762mm)	48"(1219mm)	54"(1372mm)	WUCP-4854- S 55	\$ 1727.58	\$ 1840.93	\$ 2320.45	\$ 2433.80	\$ 2514.26	\$ 2719.28	\$ 3258.98	\$3464.00
		60"(1524mm)	WUCP-4860- S 55	1765.34	1881.24	2376.88	2492.78	2581.29	2798.22	3354.76	3571.69
		66"(1676mm)	WUCP-4866- S 55	1803.10	1921.55	2433.31	2551.76	2648.32	2877.16	3450.54	3679.38
		72"(1829mm)	WUCP-4872- S 55	2046.63	2167.63	2695.51	2816.51	2921.12	3161.87	3752.09	3992.84
18"(457mm)	54"(1372mm)	60"(1524mm)	WUCP-5460- S 33	\$ 1717.80	\$ 1829.39	\$ 2348.01	\$ 2459.60	N/A	N/A	N/A	N/A
		66"(1676mm)	WUCP-5466- S 33	1755.56	1869.70	2404.44	2518.58	N/A	N/A	N/A	N/A
		72"(1829mm)	WUCP-5472- S 33	1999.09	2115.78	2666.64	2783.33	N/A	N/A	N/A	N/A
24"(610mm)	54"(1372mm)	60"(1524mm)	WUCP-5460- S 44	\$ 1760.45	\$ 1875.47	\$ 2390.66	\$ 2505.68	N/A	N/A	N/A	N/A
		66"(1676mm)	WUCP-5466- S 44	1798.21	1915.78	2447.09	2564.66	N/A	N/A	N/A	N/A
		72"(1829mm)	WUCP-5472- S 44	2041.74	2161.86	2709.29	2829.41	N/A	N/A	N/A	N/A
30"(762mm)	54"(1372mm)	60"(1524mm)	WUCP-5460- S 55	\$ 1803.10	\$ 1921.55	\$ 2433.31	\$ 2551.76	N/A	N/A	N/A	N/A
		66"(1676mm)	WUCP-5466- S 55	1840.86	1961.86	2489.74	2610.74	N/A	N/A	N/A	N/A
		72"(1829mm)	WUCP-5472- S 55	2084.39	2207.94	2751.94	2875.49	N/A	N/A	N/A	N/A
18"(457mm)	60"(1524mm)	66"(1676mm)	WUCP-6066- S 33	\$ 1793.32	\$ 1910.01	\$ 2460.87	\$ 2577.56	N/A	N/A	N/A	N/A
		72"(1829mm)	WUCP-6072- S 33	2036.85	2156.09	2723.07	2842.31	N/A	N/A	N/A	N/A
24"(610mm)	60"(1524mm)	66"(1676mm)	WUCP-6066- S 44	\$ 1835.97	\$ 1956.09	\$ 2503.52	\$ 2623.64	N/A	N/A	N/A	N/A
		72"(1829mm)	WUCP-6072- S 44	2079.50	2202.17	2765.72	2888.39	N/A	N/A	N/A	N/A
30"(762mm)	60"(1524mm)	66"(1676mm)	WUCP-6066- S 55	\$ 1878.62	\$ 2002.17	\$ 2546.17	\$ 2669.72	N/A	N/A	N/A	N/A
		72"(1829mm)	WUCP-6072- S 55	2122.15	2248.25	2808.37	2934.47	N/A	N/A	N/A	N/A

Adaptable Worksurfaces — Corner

Angled Corner – 90°

Angled

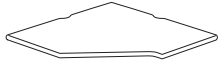

(Left-hand orientation)



(Right-hand orientation)

WUCU

Angled Transitional

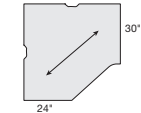
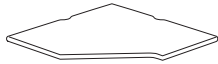

(Left-hand orientation)

WUCF-L45

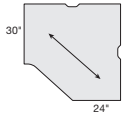

(Right-hand orientation)

WUCF

Class CA

To Order, Specify:

1) Product number, including:

1 Surface Option:

L Laminate

W Wood

2 Edge Option:

Laminate:

J Edgeband

F Knife

Wood:

K Edgeband

U Knife

3 Wireway Option:

A Notched

C Without

4 Orientation (as seated):

(Angled Corner only)

R Right-hand

L Left-hand

2) Laminate color or Wood finish color.

3) Edge trim color (laminite only).

Left/Right Depth	Width	Number	1 2 3 4		HPL Edgeband (J)		HPL Knife Edge (F)		Wood Edgeband (K)		Wood Knife Edge (U)	
			A	B	A	B	A	B	A	B		
Angled												
18"(457mm)	36"(914mm)	WUCU-3636-	S	33	\$ 957.58	\$1009.93	\$1260.74	\$ 1313.09	\$1350.42	\$ 1425.18	\$ 1733.89	\$ 1808.65
	42"(1067mm)	WUCU-4242-	S	33	1032.58	1097.29	1400.96	1465.67	1515.66	1636.53	1983.37	2104.24
	48"(1219mm)	WUCU-4848-	S	33	1201.06	1278.13	1634.66	1711.73	1774.38	1941.36	2326.33	2493.31
	54"(1372mm)	WUCU-5454-	S	33	1369.54	1458.97	1868.36	1957.79	N/A	N/A	N/A	N/A
24"(610mm)	36"(914mm)	WUCU-3636-	S	44	\$ 996.88	\$1052.37	\$ 1312.12	\$ 1367.61	\$1406.76	\$ 1489.12	\$ 1776.39	\$ 1858.75
	42"(1067mm)	WUCU-4242-	S	44	1071.88	1139.73	1452.34	1520.19	1572.00	1700.47	2025.87	2154.34
	48"(1219mm)	WUCU-4848-	S	44	1240.36	1320.57	1686.04	1766.25	1830.72	2005.30	2368.83	2543.41
	54"(1372mm)	WUCU-5454-	S	44	1408.84	1501.41	1919.74	2012.31	N/A	N/A	N/A	N/A
30"(762mm)	36"(914mm)	WUCU-3636-	S	55	\$1036.18	\$1094.81	\$1363.50	\$ 1422.13	\$1463.10	\$ 1553.06	\$ 1818.89	\$ 1908.85
	42"(1067mm)	WUCU-4242-	S	55	1111.18	1182.17	1503.72	1574.71	1628.34	1764.41	2068.37	2204.44
	48"(1219mm)	WUCU-4848-	S	55	1279.66	1363.01	1737.42	1820.77	N/A	N/A	N/A	N/A
	54"(1372mm)	WUCU-5454-	S	55	1448.14	1543.85	1971.12	2066.83	N/A	N/A	N/A	N/A
Angled Transitional												
18"(457mm)/24"(610mm)	36"(914mm)	WUCF-3636-	S	34	\$ 883.75	\$ 937.67	\$ 1192.95	\$ 1246.87	\$1285.11	\$ 1363.67	\$ 1661.66	\$ 1740.22
	42"(1067mm)	WUCF-4242-	S	34	1052.23	1118.51	1426.65	1492.93	1543.83	1668.50	2004.62	2129.29
	48"(1219mm)	WUCF-4848-	S	34	1220.71	1299.35	1660.35	1738.99	1802.55	1973.33	2347.58	2518.36
	54"(1372mm)	WUCF-5454-	S	34	1389.19	1480.19	1894.05	1985.05	N/A	N/A	N/A	N/A
24"(610mm)/18"(457mm)	36"(914mm)	WUCF-3636-	S	43	\$ 883.75	\$ 937.67	\$ 1192.95	\$ 1246.87	\$1285.11	\$ 1363.67	\$ 1661.66	\$ 1740.22
	42"(1067mm)	WUCF-4242-	S	43	1052.23	1118.51	1426.65	1492.93	1543.83	1668.50	2004.62	2129.29
	48"(1219mm)	WUCF-4848-	S	43	1220.71	1299.35	1660.35	1738.99	1802.55	1973.33	2347.58	2518.36
	54"(1372mm)	WUCF-5454-	S	43	1389.19	1480.19	1894.05	1985.05	N/A	N/A	N/A	N/A
24"(610mm)/30"(762mm)	36"(914mm)	WUCF-3636-	S	45	\$ 923.05	\$ 980.11	\$1244.33	\$ 1301.39	\$ 1341.45	\$ 1427.61	\$ 1704.16	\$ 1790.32
	42"(1067mm)	WUCF-4242-	S	45	1091.53	1160.95	1478.03	1547.45	1600.17	1732.44	2047.12	2179.39
	48"(1219mm)	WUCF-4848-	S	45	1260.01	1341.79	1711.73	1793.51	N/A	N/A	N/A	N/A
	54"(1372mm)	WUCF-5454-	S	45	1428.49	1522.63	1945.43	2039.57	N/A	N/A	N/A	N/A
30"(762mm)/24"(610mm)	36"(914mm)	WUCF-3636-	S	54	\$ 923.05	\$ 980.11	\$1244.33	\$ 1301.39	\$ 1341.45	\$ 1427.61	\$ 1704.16	\$ 1790.32
	42"(1067mm)	WUCF-4242-	S	54	1091.53	1160.95	1478.03	1547.45	1600.17	1732.44	2047.12	2179.39
	48"(1219mm)	WUCF-4848-	S	54	1260.01	1341.79	1711.73	1793.51	N/A	N/A	N/A	N/A
	54"(1372mm)	WUCF-5454-	S	54	1428.49	1522.63	1945.43	2039.57	N/A	N/A	N/A	N/A

Adaptable Worksurfaces — Convergent

General Specifications

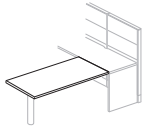

WURV
Rectangular Convergent



WURD
D-Shaped Convergent

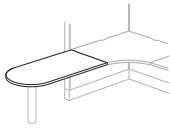

WUDD
D-Shaped Ender
Convergent

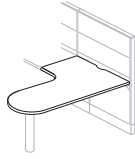

WUCD-L
D-Shaped Convergent,
Wrap-Around

Common Features

- Includes worksurface and tie plate.
- Available in high-pressure laminate (HPL) or wood veneer.
- Laminate edge option:
 - [J] 3mm edgeband on user side(s) with 1mm edgeband on sides and back (width).
 - [F] Knife edge on user side(s) and 1mm edgeband on sides and back (width). Knife edge profile receives a clear coat finish.
- Wood veneer edge option:
 - [K] 3mm edgeband on user side(s) with 1mm edgeband on sides and back (width).
 - [U] Knife edge on user side(s) and 1mm edgeband on sides and back (width). Knife edge profile receives a clear coat finish.
- Laminate Grade E available on Rectangular worksurfaces only.
- Worksurfaces predrilled to accept most support options. 36"(914mm)W and above are predrilled for pedestals.
- Optional wireway:
 - Wireway will be color-matched to solid side/back edge trim. Wood veneer or patterned/wood grain laminate will have a Charcoal wireway.
 - Refer to Specification Guide for wireway details.
- Optional Belong Hatch cutout:
 - Laminate tops only with one cutout.
 - Available on worksurfaces 30"(762mm), 34"(864mm) and 36"(914mm)D and widths of 60"(1524mm) and 72"(1829mm)
 - Requires separately specified Belong Hatch.
 - Refer to Specification Guide for cutout details.
- **Installed worksurfaces without wireway will not allow clearance for power plug.**
- Depth, width and length shown in nominal dimensions.

Specification Tips

- **Must be attached to a panel or face of a straight worksurface (exception: D-Shaped Ender).**
- **Worksurface support is specific to product line and worksurface edge guidelines; separately specified.**
- Convergent worksurfaces require floor support. Please select one of the following options:
 - Worksurface support post or column
 - Attached lower storage
- Knife edge requires use of worksurface supports for that application; worksurface support panel and/or side bracket for use with knife edge.
- Intermediate support is required for unsupported worksurface span greater than 60"(1524mm).

Note: Separately specified worksurface reinforcement bar provides additional support for worksurfaces with 60"(1524mm) spans that are heavily loaded and not otherwise supported by mid-span cantilevers, worksurface support panels, columns, legs or attached lower storage.

Adaptable Worksurfaces — Convergent Rectangular

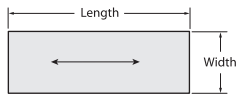
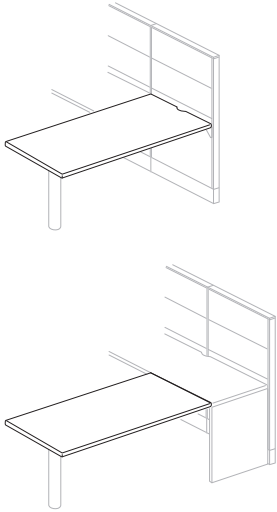

WURV
Class CA

To Order, Specify:

1) Product number, including:

1 Surface Option:

- L** Laminate
- W** Wood

2 Edge Option:

- Laminate:
- J** Edgeband
 - F** Knife

- Wood:
- K** Edgeband
 - U** Knife

3 Wireway Option:

- A** Notched
- C** Without

2) Laminate color or Wood finish color.

3) Edge trim color (laminite only).

Width	Length	Number 1 2 3	HPL Edgeband (J)			HPL Knife Edge (F)			Wood Edgeband (K)		Wood Knife Edge (U)	
			A	B	E	A	B	E	A	B	A	B
24"(610mm)	36"(914mm)	WURV-2436- S	\$ 575.76	\$ 610.59	\$ 717.80	\$ 930.04	\$ 964.87	\$1072.08	\$ 1378.55	\$ 1439.01	\$ 1814.72	\$ 1875.18
	42"(1067mm)	WURV-2442- S	652.60	687.43	794.64	1027.18	1062.01	1169.22	1492.79	1553.25	1961.96	2022.42
	48"(1219mm)	WURV-2448- S	732.00	766.83	874.04	1135.00	1169.83	1277.04	1607.03	1667.49	2122.40	2182.86
	54"(1372mm)	WURV-2454- S	808.84	843.67	950.88	1232.14	1266.97	1374.18	1721.27	1781.73	2269.64	2330.10
	60"(1524mm)	WURV-2460- S	888.24	923.07	1030.28	1339.96	1374.79	1482.00	1835.51	1895.97	2430.08	2490.54
	66"(1676mm)	WURV-2466- S	966.36	1001.19	1108.40	1442.44	1477.27	1584.48	1949.75	2010.21	2583.92	2644.38
	72"(1829mm)	WURV-2472- S	1043.20	1078.03	1185.24	1539.58	1574.41	1681.62	2063.99	2124.45	2731.16	2791.62
30"(762mm)	36"(914mm)	WURV-3036- S	\$ 683.26	\$ 718.09	\$ 825.30	\$ 1124.17	\$ 1159.00	\$1266.21	\$ 1514.16	\$ 1574.62	\$2004.77	\$2065.23
	42"(1067mm)	WURV-3042- S	756.74	791.57	898.78	1217.95	1252.78	1359.99	1646.10	1706.56	2169.71	2230.17
	48"(1219mm)	WURV-3048- S	832.78	867.61	974.82	1322.41	1357.24	1464.45	1778.04	1838.50	2347.85	2408.31
	54"(1372mm)	WURV-3054- S	906.26	941.09	1048.30	1416.19	1451.02	1558.23	1909.98	1970.44	2512.79	2573.25
	60"(1524mm)	WURV-3060- S	982.30	1017.13	1124.34	1520.65	1555.48	1662.69	2041.92	2102.38	2690.93	2751.39
	66"(1676mm)	WURV-3066- S	1057.06	1091.89	1199.10	1619.77	1654.60	1761.81	2173.86	2234.32	2862.47	2922.93
	72"(1829mm)	WURV-3072- S	1130.54	1165.37	1272.58	1713.55	1748.38	1855.59	2305.80	2366.26	3027.41	3087.87
36"(914mm)	36"(914mm)	WURV-3636- S	\$ 757.21	\$ 792.04	\$ 899.25	\$1232.31	\$ 1267.14	\$ 1374.35	\$ 1611.31	\$ 1671.77	\$ 2112.80	\$ 2173.26
	42"(1067mm)	WURV-3642- S	834.05	868.88	976.09	1329.45	1364.28	1471.49	1802.59	1863.05	2337.08	2397.54
	48"(1219mm)	WURV-3648- S	913.45	948.28	1055.49	1437.27	1472.10	1579.31	1993.87	2054.33	2574.56	2635.02
	54"(1372mm)	WURV-3654- S	990.29	1025.12	1132.33	1534.41	1569.24	1676.45	2185.15	2245.61	2798.84	2859.30
	60"(1524mm)	WURV-3660- S	1069.69	1104.52	1211.73	1642.23	1677.06	1784.27	2376.43	2436.89	3036.32	3096.78
	66"(1676mm)	WURV-3666- S	1147.81	1182.64	1289.85	1744.71	1779.54	1886.75	2567.71	2628.17	3267.20	3327.66
	72"(1829mm)	WURV-3672- S	1224.65	1259.48	1366.69	1841.85	1876.68	1983.89	2758.99	2819.45	3491.48	3551.94

Adaptable Worksurfaces — Convergent

D-Shape Convergent

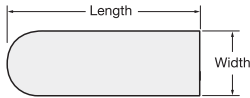
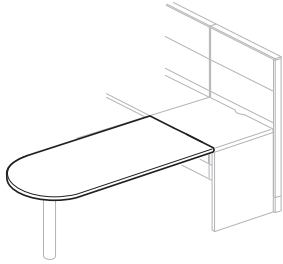
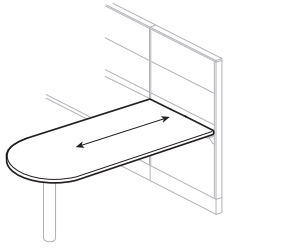

WURD
Class CA

To Order, Specify:

1) Product number, including:

1 Surface Option:

- L** Laminate
- W** Wood

2 Edge Option:

- Laminate:
- J** Edgeband
 - F** Knife
- Wood:
- K** Edgeband
 - U** Knife

3 Wireway Option:

- A** Notched
- C** Without

2) Laminate color or Wood finish color.

3) Edge trim color (laminite only).

Width	Length	Number ① ② ③	HPL Edgeband (J)		HPL Knife Edge (F)		Wood Edgeband (K)		Wood Knife Edge (U)	
			A	B	A	B	A	B	A	B
24"(610mm)	36"(914mm)	WURD-2436- S	\$ 814.47	\$ 850.52	\$ 1321.98	\$ 1358.03	\$ 1551.03	\$ 1613.60	\$2005.29	\$ 2067.86
	42"(1067mm)	WURD-2442- S	894.09	935.78	1423.25	1464.94	1764.45	1838.36	2266.96	2340.87
	48"(1219mm)	WURD-2448- S	976.35	1024.62	1535.82	1584.09	1977.87	2065.01	2547.93	2635.07
	54"(1372mm)	WURD-2454- S	1055.97	1108.94	1637.09	1690.06	2191.29	2287.88	2809.60	2906.19
	60"(1524mm)	WURD-2460- S	1138.23	1197.78	1749.66	1809.21	2404.71	2514.53	3090.57	3200.39
	66"(1676mm)	WURD-2466- S	1219.17	1284.36	1856.58	1921.77	2618.13	2739.29	3361.89	3483.05
	72"(1829mm)	WURD-2472- S	1298.79	1368.68	1957.85	2027.74	2831.55	2962.16	3623.56	3754.17
30"(762mm)	36"(914mm)	WURD-3036- S	\$ 889.16	\$ 925.21	\$ 1456.62	\$ 1492.67	\$ 1735.95	\$ 1798.52	\$ 2246.55	\$ 2309.12
	42"(1067mm)	WURD-3042- S	965.24	1006.93	1554.35	1596.04	1952.25	2026.16	2511.10	2585.01
	48"(1219mm)	WURD-3048- S	1043.96	1092.23	1663.38	1711.65	2168.55	2255.69	2794.95	2882.09
	54"(1372mm)	WURD-3054- S	1120.04	1173.01	1761.11	1814.08	2384.85	2481.44	3059.50	3156.09
	60"(1524mm)	WURD-3060- S	1198.76	1258.31	1870.14	1929.69	2601.15	2710.97	3343.35	3453.17
	66"(1676mm)	WURD-3066- S	1276.16	1341.35	1973.52	2038.71	2817.45	2938.61	3617.55	3738.71
	72"(1829mm)	WURD-3072- S	1352.24	1422.13	2071.25	2141.14	3033.75	3164.36	3882.10	4012.71
36"(914mm)	36"(914mm)	WURD-3636- S	\$ 949.95	\$ 986.00	\$ 1523.00	\$ 1559.05	\$ 1808.98	\$ 1871.55	\$ 2330.85	\$ 2393.42
	42"(1067mm)	WURD-3642- S	1029.57	1071.26	1624.27	1665.96	2028.22	2102.13	2598.34	2672.25
	48"(1219mm)	WURD-3648- S	1111.83	1160.10	1736.84	1785.11	2247.46	2334.60	2885.13	2972.27
	54"(1372mm)	WURD-3654- S	1191.45	1244.42	1838.11	1891.08	2466.70	2563.29	3152.62	3249.21
	60"(1524mm)	WURD-3660- S	1273.71	1333.26	1950.68	2010.23	2685.94	2795.76	3439.41	3549.23
	66"(1676mm)	WURD-3666- S	1354.65	1419.84	2057.60	2122.79	2905.18	3026.34	3716.55	3837.71
	72"(1829mm)	WURD-3672- S	1434.27	1504.16	2158.87	2228.76	3124.42	3255.03	3984.04	4114.65

Adaptable Worksurfaces — Convergent

D-Shape Ender Convergent

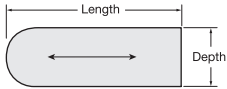
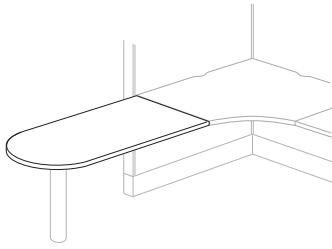

WUDD
Class CA

Unique Specification

- Must be attached to the depth of adjoining worksurface.

To Order, Specify:

- 1) Product number, including:

1 Surface Option:

- L** Laminate
- W** Wood

2 Edge Option:

Laminate:

- J** Edgeband
- F** Knife

Wood:

- K** Edgeband
- U** Knife

- 2) Laminate color or Wood finish color.

- 3) Edge trim color (laminite only).

Depth	Length	Number 1 2	HPL Edgeband (J)		HPL Knife Edge (F)		Wood Edgeband (K)		Wood Knife Edge (U)	
			A	B	A	B	A	B	A	B
18"(457mm)	36"(914mm)	WUDD-1836- SC	\$ 697.41	\$ 730.16	\$ 953.05	\$ 985.80	\$ 1431.84	\$ 1495.35	\$ 1859.47	\$ 1922.98
	42"(1067mm)	WUDD-1842- SC	761.97	800.12	1040.77	1078.92	1628.34	1703.31	2113.63	2188.60
	48"(1219mm)	WUDD-1848- SC	826.53	870.08	1128.49	1172.04	1824.84	1911.27	2367.79	2454.22
	54"(1372mm)	WUDD-1854- SC	891.09	940.04	1216.21	1265.16	2021.34	2119.23	2621.95	2719.84
	60"(1524mm)	WUDD-1860- SC	955.65	1010.00	1303.93	1358.28	2217.84	2327.19	2876.11	2985.46
	66"(1676mm)	WUDD-1866- SC	1020.21	1079.96	1391.65	1451.40	2414.34	2535.15	3130.27	3251.08
	72"(1829mm)	WUDD-1872- SC	1084.77	1149.92	1479.37	1544.52	2610.84	2743.11	3384.43	3516.70
24"(610mm)	36"(914mm)	WUDD-2436- SC	\$ 751.75	\$ 784.50	\$ 1028.27	\$ 1061.02	\$ 1499.24	\$ 1562.75	\$ 1949.79	\$ 2013.30
	42"(1067mm)	WUDD-2442- SC	833.65	871.80	1133.33	1171.48	1718.72	1793.69	2226.93	2301.90
	48"(1219mm)	WUDD-2448- SC	915.55	959.10	1238.39	1281.94	1938.20	2024.63	2504.07	2590.50
	54"(1372mm)	WUDD-2454- SC	997.45	1046.40	1343.45	1392.40	2157.68	2255.57	2781.21	2879.10
	60"(1524mm)	WUDD-2460- SC	1079.35	1133.70	1448.51	1502.86	2377.16	2486.51	3058.35	3167.70
	66"(1676mm)	WUDD-2466- SC	1161.25	1221.00	1553.57	1613.32	2596.64	2717.45	3335.49	3456.30
	72"(1829mm)	WUDD-2472- SC	1243.15	1308.30	1658.63	1723.78	2816.12	2948.39	3612.63	3744.90
30"(762mm)	36"(914mm)	WUDD-3036- SC	\$ 825.34	\$ 858.09	\$ 1392.67	\$ 1425.42	\$ 1678.29	\$ 1741.80	\$ 2185.99	\$ 2249.50
	42"(1067mm)	WUDD-3042- SC	903.76	941.91	1494.25	1532.40	1897.77	1972.74	2463.13	2538.10
	48"(1219mm)	WUDD-3048- SC	982.18	1025.73	1595.83	1639.38	2117.25	2203.68	2740.27	2826.70
	54"(1372mm)	WUDD-3054- SC	1060.60	1109.55	1697.41	1746.36	2336.73	2434.62	3017.41	3115.30
	60"(1524mm)	WUDD-3060- SC	1139.02	1193.37	1798.99	1853.34	2556.21	2665.56	3294.55	3403.90
	66"(1676mm)	WUDD-3066- SC	1217.44	1277.19	1900.57	1960.32	2775.69	2896.50	3571.69	3692.50
	72"(1829mm)	WUDD-3072- SC	1295.86	1361.01	2002.15	2067.30	2995.17	3127.44	3848.83	3981.10

Adaptable Worksurfaces — Convergent

D-Shape Convergent Wrap-Around

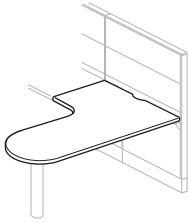

Unique Specifications

- 36"(914mm)W surfaces have a 24"(610mm) diameter D-shaped radius.
- 42"(1067mm)-60"(1524mm)W surfaces have a 30"(762mm) diameter D-shaped radius.
- Mini cantilever brackets are for use with 18"(457mm)D worksurface with knife edge only.

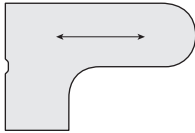

(Right-hand orientation)

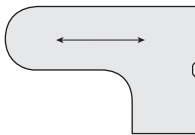

(Left-hand orientation)

WUCD-L
Class CA

To Order, Specify:

1) Product number, including:

1 Surface Option:

- L** Laminate
- W** Wood

2 Edge Option:

Laminate:

- J** Edgeband
- F** Knife

Wood:

- K** Edgeband
- U** Knife

3 Wireway Option:

- A** Notched
- C** Without

4 Orientation (as seated):

- R** Right-hand
- L** Left-hand

2) Laminate color or Wood finish color.

3) Edge trim color (laminite only).

Depth	Width	Length	Number	HPL Edgeband (J)			HPL Knife Edge (F)		Wood Edgeband (K)		Wood Knife Edge (U)		
				1	2	3	4	A	B	A	B	A	B
18"(457mm)	36"(914mm)	60"(1524mm)	WUCD-3660-	S	3	\$1596.02	\$1710.93	\$2019.30	\$2134.21	\$2678.16	\$2874.17	\$3231.47	\$3427.48
		66"(1676mm)	WUCD-3666-	S	3	1647.68	1766.31	2091.90	2210.53	2774.40	2987.33	3355.85	3568.78
		72"(1829mm)	WUCD-3672-	S	3	1797.04	1919.39	2262.20	2384.55	2968.34	3198.19	3577.93	3807.78
24"(610mm)	36"(914mm)	60"(1524mm)	WUCD-3660-	S	4	\$1640.76	\$1758.56	\$2056.99	\$2174.79	\$2706.65	\$2907.48	\$3258.41	\$3459.24
		66"(1676mm)	WUCD-3666-	S	4	1692.42	1813.94	2129.59	2251.11	2802.89	3020.64	3382.79	3600.54
		72"(1829mm)	WUCD-3672-	S	4	1841.78	1967.02	2299.89	2425.13	2996.83	3231.50	3604.87	3839.54
30"(762mm)	36"(914mm)	60"(1524mm)	WUCD-3660-	S	5	\$1685.50	\$1806.19	\$2094.68	\$2215.37	\$2735.14	\$2940.79	\$3285.35	\$3491.00
		66"(1676mm)	WUCD-3666-	S	5	1737.16	1861.57	2167.28	2291.69	2831.38	3053.95	3409.73	3632.30
		72"(1829mm)	WUCD-3672-	S	5	1886.52	2014.65	2337.58	2465.71	3025.32	3264.81	3631.81	3871.30
18"(457mm)	42"(1067mm)	60"(1524mm)	WUCD-4260-	S	3	\$1692.42	\$1813.94	\$2129.59	\$2251.11	\$2802.89	\$3020.64	\$3382.79	\$3600.54
		66"(1676mm)	WUCD-4266-	S	3	1744.08	1869.32	2202.19	2327.43	2899.13	3133.80	3507.17	3741.84
		72"(1829mm)	WUCD-4272-	S	3	1795.74	1924.70	2274.79	2403.75	2995.37	3246.96	3631.55	3883.14
24"(610mm)	42"(1067mm)	60"(1524mm)	WUCD-4260-	S	4	\$1737.16	\$1861.57	\$2167.28	\$2291.69	\$2831.38	\$3053.95	\$3409.73	\$3632.30
		66"(1676mm)	WUCD-4266-	S	4	1788.82	1916.95	2239.88	2368.01	2927.62	3167.11	3534.11	3773.60
		72"(1829mm)	WUCD-4272-	S	4	1840.48	1972.33	2312.48	2444.33	3023.86	3280.27	3658.49	3914.90
30"(762mm)	42"(1067mm)	60"(1524mm)	WUCD-4260-	S	5	\$1781.90	\$1909.20	\$2204.97	\$2332.27	\$2859.87	\$3087.26	\$3436.67	\$3664.06
		66"(1676mm)	WUCD-4266-	S	5	1833.56	1964.58	2277.57	2408.59	2956.11	3200.42	3561.05	3805.36
		72"(1829mm)	WUCD-4272-	S	5	1885.22	2019.96	2350.17	2484.91	3052.35	3313.58	3685.43	3946.66
18"(457mm)	48"(1219mm)	60"(1524mm)	WUCD-4860-	S	3	\$1744.08	\$1869.32	\$2202.19	\$2327.43	\$2899.13	\$3133.80	\$3507.17	\$3741.84
		66"(1676mm)	WUCD-4866-	S	3	1795.74	1924.70	2274.79	2403.75	2995.37	3246.96	3631.55	3883.14
		72"(1829mm)	WUCD-4872-	S	3	1847.40	1980.08	2347.39	2480.07	3091.61	3360.12	3755.93	4024.44
24"(610mm)	48"(1219mm)	60"(1524mm)	WUCD-4860-	S	4	\$1788.82	\$1916.95	\$2239.88	\$2368.01	\$2927.62	\$3167.11	\$3534.11	\$3773.60
		66"(1676mm)	WUCD-4866-	S	4	1840.48	1972.33	2312.48	2444.33	3023.86	3280.27	3658.49	3914.90
		72"(1829mm)	WUCD-4872-	S	4	1892.14	2027.71	2385.08	2520.65	3120.10	3393.43	3782.87	4056.20
30"(762mm)	48"(1219mm)	60"(1524mm)	WUCD-4860-	S	5	\$1833.56	\$1964.58	\$2277.57	\$2408.59	\$2956.11	\$3200.42	\$3561.05	\$3805.36
		66"(1676mm)	WUCD-4866-	S	5	1885.22	2019.96	2350.17	2484.91	3052.35	3313.58	3685.43	3946.66
		72"(1829mm)	WUCD-4872-	S	5	1936.88	2075.34	2422.77	2561.23	3148.59	3426.74	3809.81	4087.96

Adaptable Worksurfaces — Convergent

D-Shape Convergent Wrap-Around

Depth	Width	Length	Number ①② ③④	HPL Edgeband (J)		HPL Knife Edge (F)		Wood Edgeband (K)		Wood Knife Edge (U)	
				A	B	A	B	A	B	A	B
18"(457mm)	54"(1372mm)	60"(1524mm)	WUCD-5460- S 3	\$ 1795.74	\$ 1924.70	\$ 2274.79	\$ 2403.75	N/A	N/A	N/A	N/A
		66"(1676mm)	WUCD-5466- S 3	1847.40	1980.08	2347.39	2480.07	N/A	N/A	N/A	N/A
		72"(1829mm)	WUCD-5472- S 3	1899.06	2035.46	2419.99	2556.39	N/A	N/A	N/A	N/A
24"(610mm)	54"(1372mm)	60"(1524mm)	WUCD-5460- S 4	\$ 1840.48	\$ 1972.33	\$ 2312.48	\$ 2444.33	N/A	N/A	N/A	N/A
		66"(1676mm)	WUCD-5466- S 4	1892.14	2027.71	2385.08	2520.65	N/A	N/A	N/A	N/A
		72"(1829mm)	WUCD-5472- S 4	1943.80	2083.09	2457.68	2596.97	N/A	N/A	N/A	N/A
30"(762mm)	54"(1372mm)	60"(1524mm)	WUCD-5460- S 5	\$ 1885.22	\$ 2019.96	\$ 2350.17	\$ 2484.91	N/A	N/A	N/A	N/A
		66"(1676mm)	WUCD-5466- S 5	1936.88	2075.34	2422.77	2561.23	N/A	N/A	N/A	N/A
		72"(1829mm)	WUCD-5472- S 5	1988.54	2130.72	2495.37	2637.55	N/A	N/A	N/A	N/A
18"(457mm)	60"(1524mm)	60"(1524mm)	WUCD-6060- S 3	\$ 1847.40	\$ 1980.08	\$ 2347.39	\$ 2480.07	N/A	N/A	N/A	N/A
		66"(1676mm)	WUCD-6066- S 3	1899.06	2035.46	2419.99	2556.39	N/A	N/A	N/A	N/A
		72"(1829mm)	WUCD-6072- S 3	1950.72	2090.84	2492.59	2632.71	N/A	N/A	N/A	N/A
24"(610mm)	60"(1524mm)	60"(1524mm)	WUCD-6060- S 4	\$ 1892.14	\$ 2027.71	\$ 2385.08	\$ 2520.65	N/A	N/A	N/A	N/A
		66"(1676mm)	WUCD-6066- S 4	1943.80	2083.09	2457.68	2596.97	N/A	N/A	N/A	N/A
		72"(1829mm)	WUCD-6072- S 4	1995.46	2138.47	2530.28	2673.29	N/A	N/A	N/A	N/A
30"(762mm)	60"(1524mm)	60"(1524mm)	WUCD-6060- S 5	\$ 1936.88	\$ 2075.34	\$ 2422.77	\$ 2561.23	N/A	N/A	N/A	N/A
		66"(1676mm)	WUCD-6066- S 5	1988.54	2130.72	2495.37	2637.55	N/A	N/A	N/A	N/A
		72"(1829mm)	WUCD-6072- S 5	2040.20	2186.10	2567.97	2713.87	N/A	N/A	N/A	N/A

Adaptable Worksurfaces — Conference End

Conference End

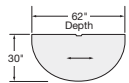
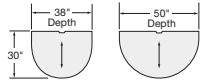

WUDC

Key Conference End

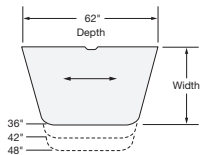
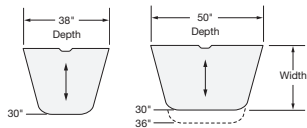
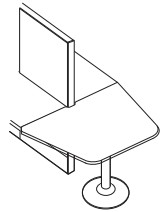

WURY
Class CA

Features

- Includes worksurface and tie plate.
- High-Pressure Laminate (HPL) with 3mm edgeband (J) or knife edge (F) on user edge and 1mm edgeband on back. Knife edge profile receives a clear coat finish.
- Wood veneer worksurface with 3mm edgeband (K) or knife (U) on user edge and 1mm edgeband on back. Knife edge profile receives a clear coat finish.
- Worksurfaces predrilled to accept most support options.
- Wireway along back edge is color-matched to solid side/back edge trim. When wood veneer or wood grain or patterned laminate is specified, wireway will be Charcoal. Refer to Specification Guide for wireway details.
- Depths and widths shown in nominal dimensions.
- Wireway required to accommodate end-of-run trim.

Specification Tips

- **Worksurface support specific to product line and worksurface edge guidelines; must be separately specified; refer to Specification Guide**
- Key ends with single support posts or columns are generally not considered to be panel supports. See load guidelines in Specification Guide to insure that the panels are properly supported.
- The back edge of the key end must be supported by either
 - Two FMK brackets (50"(1270mm)/62"(1575mm) depths)
 - A standard link bracket (pair)
 - Worksurface support panel.
 - A combination of the previous three
- **The front of the key end must be supported by one of the following:**
 - Support post or column - **REQUIRED**

To Order, Specify:

1) Product number, including:

1 Surface Option:

- L** Laminate
- W** Wood

2 Edge Option:

- Laminate:
- J** Edgeband
 - F** Knife

- Wood:
- K** Edgeband
 - U** Knife

3 Wireway Option:

- A** Notched
- D** Compose End-of-Run

2) Laminate color or Wood finish color.

3) Edge trim color (laminite only).

Note: Grain direction for Conference and Key Conference End over 62"(1575mm)D will be reversed.

Depth	Width	Number ①②③	HPL Edgeband (J)		HPL Knife Edge (F)		Wood Edgeband (K)		Wood Knife Edge (U)	
			A	B	A	B	A	B	A	B
Conference End										
38"(965mm)	30"(762mm)	WUDC-3830- [] [] S []	\$ 1051.87	\$ 1123.83	\$ 1497.01	\$ 1568.97	\$ 3105.03	\$ 3254.76	\$ 3963.75	\$ 4113.48
50"(1270mm)	30"(762mm)	WUDC-5030- [] [] S []	1105.51	1182.15	1569.25	1645.89	3268.23	3448.56	4172.07	4352.40
62"(1575mm)	30"(762mm)	WUDC-6230- [] [] S []	1159.15	1240.47	1641.49	1722.81	3431.43	3642.36	4380.39	4591.32
Key Conference End										
38"(965mm)	30"(762mm)	WURY-3830- [] [] S []	\$ 1389.76	\$ 1489.32	\$ 1953.76	\$ 2053.32	\$ 3766.97	\$ 4033.14	\$ 4897.68	\$ 5163.85
50"(1270mm)	30"(762mm)	WURY-5030- [] [] S []	\$ 1397.35	\$ 1497.43	\$ 1964.00	\$ 2064.08	\$ 3773.90	\$ 4041.27	\$ 4904.61	\$ 5171.98
	36"(914mm)	WURY-5036- [] [] S []	1427.37	1529.70	2002.03	2104.36	3862.47	4145.72	5018.97	5302.22
62"(1575mm)	36"(914mm)	WURY-6236- [] [] S []	\$ 1434.96	\$ 1537.81	\$ 2012.27	\$ 2115.12	\$ 3869.40	\$ 4153.85	\$ 5025.90	\$ 5310.35
	42"(1067mm)	WURY-6242- [] [] S []	1464.98	1570.08	2050.30	2155.40	3957.97	4258.30	5140.26	5440.59
	48"(1219mm)	WURY-6248- [] [] S []	1495.00	1602.35	2088.33	2195.68	4046.54	4362.75	5254.62	5570.83

Adaptable Worksurfaces — 120° Link

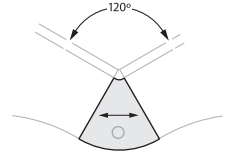
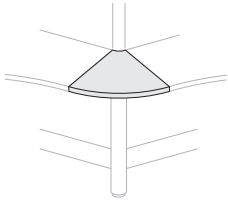

WUDZ
Class CA

Features

- Includes worksurface and tie plate.
- High-Pressure Laminate (HPL) with 3mm edgeband (J) or knife edge (F) on user edge and 1mm edgeband on sides and back. Knife edge profile receives a clear coat finish.
- Wood veneer worksurface with 3mm edgeband (K) or knife (U) on user edge and 1mm edgeband on back. Knife edge profile receives a clear coat finish.
- Worksurfaces predrilled to accept most support options.
- Depth shown in nominal dimensions.

Specification Tips

- Support column, leg or worksurface support panel may be used dependent upon application.
- Use with Corner, 120° Wrap-Around worksurfaces.
- **Worksurface support specific to product line and worksurface edge guidelines; must be separately specified; refer to Specification Guide for support and load.**
 - P-Leg
 - Support post
 - Support column
 - Worksurface support panel
 - Tie plate with 18"(457mm) depth
 - Flush mount plates with 24"(610mm) and 30"(762mm) depths
 - Standard link cantilevers
- Knife edge requires use of worksurface supports for that application; worksurface support panel and/or side bracket for use with knife edge.
- Mini cantilever brackets are for use with 18"(457mm)D worksurfaces with knife edge only.

To Order, Specify:

1) Product number, including:

1 Surface Option:

- L** Laminate
- W** Wood

2 Edge Option:

- Laminate:
- J** Edgeband
 - F** Knife
- Wood:
- K** Edgeband
 - U** Knife

2) Laminate color or Wood finish color.

3) Edge trim color (laminite only).

Depth	Number ①②	HPL Edgeband (J)		HPL Knife Edge (F)		Wood Edgeband (K)		Wood Knife Edge (U)	
		A	B	A	B	A	B	A	B
18"(457mm)	WUDZ-1820- ■ ■ SC	\$532.36	\$570.98	\$ 819.55	\$ 858.17	\$1430.40	\$1550.30	\$ 1921.36	\$ 2041.26
24"(610mm)	WUDZ-2426- ■ ■ SC	583.93	622.55	871.12	909.74	1589.70	1668.90	2080.66	2159.86
30"(762mm)	WUDZ-3032- ■ ■ SC	824.96	885.92	1204.63	1265.59	2218.76	2367.09	2920.95	3069.28

Adaptable Worksurfaces — Rectangular Key

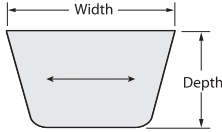
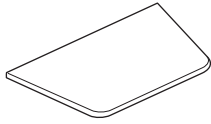

WURY
Class CA

Features

- Includes worksurface and tie plate.
- High-Pressure Laminate (HPL) with 3mm edgeband (J) or knife edge (F) on user edge and 1mm edgeband on sides and back. Knife edge profile receives a clear coat finish.
- Wood veneer surface with 3mm edgeband (K) or knife (U) on user edge and 1mm edgeband on sides and back. Knife edge profile receives a clear coat finish.
- **Worksurface width dimension attaches directly to panel and matches panel width.**
- Worksurfaces predrilled to accept most support options.
- Optional wireway can be specified to accommodate panel end-of-run trim. Wireway is color-matched to solid side/edge trim. When wood veneer or wood grain or patterned laminate is specified, wireway will be Charcoal. Refer to Specification Guide for wireway details.
- **Installed worksurfaces without wireway will not allow clearance for power plug.**
- Depths and widths shown in nominal dimensions.

Specification Tips

- **Worksurface support specific to product line and worksurface edge guidelines; must be separately specified; refer to Specification Guide for support and load.**
- Knife edge requires use of worksurface supports for that application; worksurface support panel and/or side bracket for use with knife edge.
- **Support post or column is required.**

To Order, Specify:

1) Product number, including:

1 Surface Option:

L Laminate

W Wood

2 Edge Option:

Laminate:

J Edgeband

F Knife

Wood:

K Edgeband

U Knife

3 Wireway/Cutout Option:

A Notched

C Without

2) Laminate color or Wood finish color.

3) Edge trim color (laminite only).

Width	Length	Number ①② ③	HPL Edgeband (J)		HPL Knife Edge (F)		Wood Edgeband (K)		Wood Knife Edge (U)	
			A	B	A	B	A	B	A	B
30"(762mm)	36"(914mm)	WURY-3036- ■ ■ S ■	\$ 1130.25	\$ 1213.15	\$ 1602.03	\$ 1684.93	\$ 3083.39	\$ 3267.39	\$ 4106.75	\$ 4290.75
	48"(1219mm)	WURY-3048- ■ ■ S ■	1201.40	1289.16	1698.26	1786.02	3248.16	3461.51	4319.44	4532.79
36"(914mm)	48"(1219mm)	WURY-3648- ■ ■ S ■	\$ 1275.00	\$ 1368.00	\$ 1795.11	\$ 1888.11	\$ 3439.23	\$ 3686.57	\$ 4564.08	\$ 4811.42
	60"(1524mm)	WURY-3660- ■ ■ S ■	1346.15	1444.01	1891.34	1989.20	3604.00	3880.69	4776.77	5053.46
	72"(1829mm)	WURY-3672- ■ ■ S ■	1417.30	1520.02	1987.57	2090.29	3768.77	4074.81	4989.46	5295.50
42"(1067mm)	60"(1524mm)	WURY-4260- ■ ■ S ■	\$ 1419.75	\$ 1522.85	\$ 1988.19	\$ 2091.29	\$ 3795.07	\$ 4105.75	\$ 5021.41	\$ 5332.09
	72"(1829mm)	WURY-4272- ■ ■ S ■	1490.90	1598.86	2084.42	2192.38	3959.84	4299.87	5234.10	5574.13
48"(1219mm)	60"(1524mm)	WURY-4860- ■ ■ S ■	\$ 1493.35	\$ 1601.69	\$ 2085.04	\$ 2193.38	\$ 3986.14	\$ 4330.81	\$ 5266.05	\$ 5610.72
	72"(1829mm)	WURY-4872- ■ ■ S ■	1564.50	1677.70	2181.27	2294.47	4150.91	4524.93	5478.74	5852.76

Adaptable Worksurfaces

Countertop

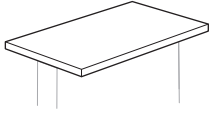

WUTS
Class CA

Features

- Includes countertop and tie plate.
- High-Pressure Laminate (HPL) with 3mm edgeband (J) or knife edge (F) on user edge and 1mm edgeband on ends. Knife edge profile receives a clear coat finish.
- Wood veneer surface with 3mm edgeband (K) or knife (U) on user edges and 1mm edgeband on ends. Knife edge profile receives a clear coat finish.
- Depths and widths shown in nominal dimensions.

Specification Tips

- For use in applications that match panel width or multiple panel widths.
- **Countertop support specific to product line; must be separately specified.**

To Order, Specify:

1) Product number, including:

1 Surface Option:

L Laminate

W Wood

2 Edge Option:

Laminate:

J Edgeband

F Knife

Wood:

K Edgeband

U Knife

2) Laminate color or Wood finish color.

3) Edge trim color (laminite only).

Width	Length	Number ①②	HPL Edgeband (J)		HPL Knife Edge (F)		Wood Edgeband (K)		Wood Knife Edge (U)	
			A	B	A	B	A	B	A	B
12"(305mm)	24"(610mm)	WUTS-1224- SC	\$ 578.01	\$ 620.42	\$1090.16	\$ 1132.57	\$ 1011.13	\$1050.48	\$ 1539.38	\$ 1578.73
	30"(762mm)	WUTS-1230- SC	608.07	652.64	1130.78	1175.35	1060.75	1108.80	1602.44	1650.49
	36"(914mm)	WUTS-1236- SC	638.13	684.86	1171.40	1218.13	1110.37	1167.12	1665.50	1722.25
	42"(1067mm)	WUTS-1242- SC	668.19	717.08	1212.02	1260.91	1159.99	1225.44	1728.56	1794.01
	48"(1219mm)	WUTS-1248- SC	698.25	749.30	1252.64	1303.69	1209.61	1283.76	1791.62	1865.77
	54"(1372mm)	WUTS-1254- SC	728.31	781.52	1293.26	1346.47	1259.23	1342.08	1854.68	1937.53
	60"(1524mm)	WUTS-1260- SC	758.37	813.74	1333.88	1389.25	1308.85	1400.40	1917.74	2009.29
	66"(1676mm)	WUTS-1266- SC	788.43	845.96	1374.50	1432.03	1358.47	1458.72	1980.80	2081.05
	72"(1829mm)	WUTS-1272- SC	818.49	878.18	1415.12	1474.81	1408.09	1517.04	2043.86	2152.81
	78"(1981mm)	WUTS-1278- SC	848.55	910.40	1455.74	1517.59	1457.71	1575.36	2106.92	2224.57
	84"(2134mm)	WUTS-1284- SC	878.61	942.62	1496.36	1560.37	1507.33	1633.68	2169.98	2296.33
	90"(2286mm)	WUTS-1290- SC	908.67	974.84	1536.98	1603.15	1556.95	1692.00	2233.04	2368.09
	96"(2438mm)	WUTS-1296- SC	938.73	1007.06	1577.60	1645.93	1606.57	1750.32	2296.10	2439.85
	102"(2591mm)	WUTS-12A2- SC	968.79	1039.28	1618.22	1688.71	1656.19	1808.64	2359.16	2511.61
	108"(2743mm)	WUTS-12A8- SC	998.85	1071.50	1658.84	1731.49	1705.81	1866.96	2422.22	2583.37
	114"(2896mm)	WUTS-12B4- SC	1028.91	1103.72	1699.46	1774.27	1755.43	1925.28	2485.28	2655.13
120"(3048mm)	WUTS-12C0- SC	1058.97	1135.94	1740.08	1817.05	1805.05	1983.60	2548.34	2726.89	

Adaptable Worksurfaces — Adjustable Split Top

Rectangular

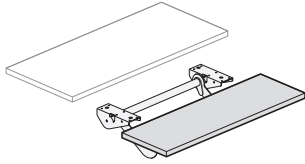

WUKR
Class CA

Features

- Includes one split rectangular split top surface with spring assist mechanism and hardware.
- Available in high-pressure laminate (HPL) only with 3mm edgeband on user edge and 1mm edgeband on sides and back.
- Spring assist mechanism:
 - Available in charcoal finish color only.
 - Spring assisted adjustment with manual lock.
 - Adjusts 6”(152mm) above and 6”(152mm) below worksurface.

Specification Tips

- For use with 18”(457mm)D adaptable worksurfaces (WURA); separately specified.
- May be used with same width worksurface or larger.
- Overall depth of worksurface with split top is 30”(762mm).
- Rectangular worksurface split top applications are designed to align with adjacent 30”(762mm)D worksurfaces.
- Split top is designed to allow pinch point clearance to accommodate cables.
- Not designed for use on worksurfaces with knife edge.
- Not for use with attached pedestals.

To Order, Specify:

- 1) Product number.
- 2) Laminate color.
- 3) Edgeband color.

Depth	Width	Minimum Worksurface	Number	HPL	
		Width		A	B
12”(305mm)	34”(864mm)	36”(914mm)	WUKR-1236-LJSC	\$2561.38	\$2980.42
	40”(1016mm)	42”(1067mm)	WUKR-1242-LJSC	2731.01	3177.83
	46”(1168mm)	48”(1219mm)	WUKR-1248-LJSC	2900.64	3375.24

Corner — 90°

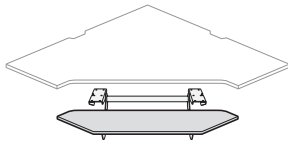

WUKC
Class CA

Features

- Includes one 90° corner split top surface with spring assist mechanism and hardware.
- Available in high-pressure laminate (HPL) only with 3mm edgeband on user edge and 1mm edgeband on sides and back.
- Spring assist mechanism:
 - Available in charcoal finish color only.
 - Spring assisted adjustment with manual lock.
 - Adjusts 6”(152mm) above and 6”(152mm) below worksurface.

Specification Tips

- For use with 18”(457mm)D x 48”(1219mm)W Corner — 90° worksurfaces (WUCN); separately specified.
- Overall depth of worksurface with split top is 30”(762mm).
- Corner worksurface split top applications are designed to align with adjacent 18”(457mm)D worksurfaces.
- Split top is designed to allow pinch point clearance to accommodate cables.
- Not designed for use with adjacent worksurfaces 24”(610mm) or 30”(762mm)D.
- Not designed for use on worksurfaces with knife edge.
- Not for use with attached pedestals.

To Order, Specify:

- 1) Product number.
- 2) Laminate color.
- 3) Edgeband color.

Depth	Width	Number	HPL	
			A	B
12”(305mm)	48”(1219mm)	WUKC-1248-LJSC	\$2731.01	\$3177.83

Worksurface Supports

Standard Cantilever Bracket

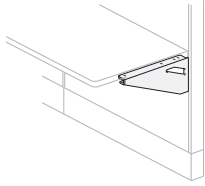

ZEBD-1600
(Right-hand shown)
Class CA

Features

- Includes one right- and/or one left-handed bracket and mounting screws.
- Provides cantilever support for the left and/or right side of worksurface.
- Installs in panel side trim rail.
- Cantilever bracket can be used on either a 18"(457mm)-, 24"(610mm)- or 30"(762mm)D worksurface.
- Mounts worksurface in one inch vertical increments from a minimum of 15"(381mm)H.
- Provides clear access leg swing when supporting 24"(610mm)- and 30"(762mm)D worksurfaces at standard 29"(737mm) height.
- (P) finish option standard in black.

To Order, Specify:

- 1) Product number.
- 1 **Color Option:**
 - P** Standard
 - C** Trim color (A, B).
- 2) Trim color if applicable.

Description	Height	Depth	Width	Number ①	Price		
					P	A C	B C
Pair	9"(229mm)	16.5"(419mm)	1.625"(41mm)	ZEBD-1600- P	\$187.61	\$276.28	\$289.42
Left-hand				ZEBD-1600- L	114.23	146.48	150.87
Right-hand				ZEBD-1600- R	114.23	146.48	150.87

Standard Mini Cantilever Bracket

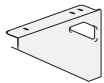

ZEBD-1000
(Right-hand shown)
Class CA

Features

- Includes one right- and/or one left-handed bracket and mounting screws.
- Provides cantilever support for the left or right side of worksurface.
- Installs in panel side trim rail.
- Cantilever bracket to be used on 18"(457mm)D rectangular radius end worksurface with edgeband.
- Mounts worksurface in one inch vertical increments from a minimum of 15"(381mm)H.
- (P) finish option standard in black.

To Order, Specify:

- 1) Product number.
- 1 **Color Option:**
 - P** Standard
 - C** Trim color (A, B).
- 2) Trim color if applicable.

Description	Height	Depth	Width	Number ①	Price		
					P	A C	B C
Pair	9"(229mm)	10.5"(267mm)	1.625"(41mm)	ZEBD-1000- P	\$ 211.69	\$300.36	\$313.50
Left-hand				ZEBD-1000- L	128.01	160.26	164.65
Right-hand				ZEBD-1000- R	128.01	160.26	164.65

Standard Link Cantilever Bracket

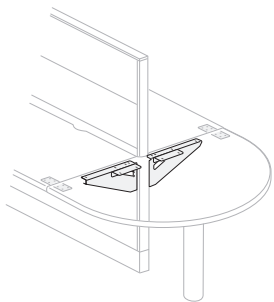

ZEBL-1600
Left Right
Class CA

Features

- Includes one right- and/or one left-handed bracket, with attached angle bracket and mounting screws.
- Provides cantilever support for the left or right side of conference end, key conference end and 120° link and the adjoining worksurface.
- Installs in panel side trim rail.
- Cantilever bracket can be used on either a 18"(457mm)-, 24"(610mm)- or 30"(762mm)D worksurface.
- Mounts worksurface in one inch vertical increments from a minimum of 15"(381mm)H.
- Provides clear access leg swing when supporting 24"(610mm)- and 30"(762mm)D worksurfaces at standard 29"(737mm) height.
- (P) finish option standard in black.

Specification Tip

- To be used with conference end, key conference end, D-shape ender and 120° link only.

To Order, Specify:

- 1) Product number.
- 1 **Color Option:**
 - P** Standard
 - C** Trim color (A, B).
- 2) Trim color if applicable.

Description	Height	Depth	Width	Number ①	Price		
					P	A C	B C
Pair	9"(229mm)	16.5"(419mm)	3.75"(95mm)	ZEBL-1600- P	\$219.86	\$308.53	\$321.67
Left-hand				ZEBL-1600- L	132.65	164.90	169.29
Right-hand				ZEBL-1600- R	132.65	164.90	169.29

Worksurface Supports

Side Bracket

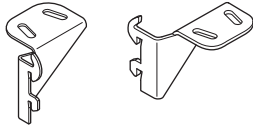

ZEBA-0000
(Right-hand)
Class CA

(Left-hand)

Features

- Includes one left- or right-hand bracket and mounting screws.
- Mounts ends of rectilinear worksurface to adjacent panel.
- Worksurface depth and return panel width must be equal.
- Standard in Charcoal finish only.

Specification Tip

- Not recommended for use with convergent worksurface.

To Order, Specify:

- 1) Product number
(No finish specification required.)

Description	Height	Depth	Width	Number	Price
Left	2"(51mm)	1.5"(38mm)	2.625"(67mm)	ZEBA-0000-PL	\$35.58
Right				ZEBA-0000-PR	35.58

Convergent Mount Bracket

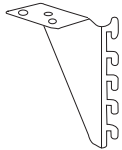

ZEBV-0000
(Right-hand)
Class CA

Features

- Includes one left- or right-hand bracket, mounting screws and anti-dislodgement clip.
- Mounts one corner of straight end of convergent worksurface to panel side rails.
- Standard in Charcoal finish only.

To Order, Specify:

- 1) Product number.
(No finish specification required.)

Description	Height	Depth	Width	Number	Price
Left	4.75"(121mm)	1.875"(48mm)	4.25"(108mm)	ZEBV-0000-PL	\$42.91
Right				ZEBV-0000-PR	42.91

Flush Mount Plate



ZUBF-0000
Class CA

Features

- Includes one bracket and mounting screws.
- Mounts straight end of convergent worksurfaces or conference end worksurfaces to panel-hung worksurfaces.
- Provides 90° attachment of two worksurfaces at the same height.
- Standard in Charcoal finish only.

To Order, Specify:

- 1) Product number.
(No finish specification required.)

	Depth	Width	Number	Price
	3"(76mm)	4"(102mm)	ZUBF-0000-PN	\$41.23

Rear-Corner Bracket

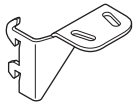

ZEBR-0000
Class CA

Features

- Includes one left-hand bracket and mounting screws.
- Attaches rear corner of worksurface to left hand side trim rail of panel.
- Standard in Charcoal finish only.
- **Required for all corner worksurfaces.**

To Order, Specify:

- 1) Product number.
(No finish specification required.)

	Height	Depth	Width	Number	Price
	2"(51mm)	1.5"(38mm)	2.625"(67mm)	ZEBR-0000-PN	\$32.69

Worksurface Supports

Counter Top Brackets

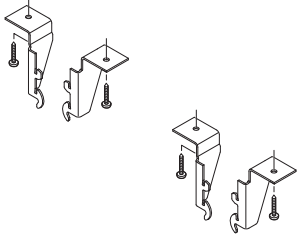

Z2BT-0000
ZEBT-0000
ZHBT-0000
Class CA

Features

- Includes countertop brackets and screws to support countertops up to 60"(1524mm) wide. For wider widths order additional brackets as needed so that brackets are positioned a maximum of 60"(1524mm) apart.
- For UniGroup radius wood top cap, specify UniGroup for radius steel top cap and add field supplied spacers to accommodate height difference.
- UniGroup Too for square painted top cap brackets are available in Metallic finish.

To Order, Specify:

- 1) Product number.
- 2) Trim color.

Description	Height	Number	Price	
			A	B
UniGroup Too for Square Painted Top Cap	2.59"(66mm)	Z2BT-0000-PNE	\$167.77	\$169.46
UniGroup for Radius Steel Top Cap	2.76"(70mm)	ZEBT-0000-PNE	167.77	N/A

Pedestal-to-Panel Bracket

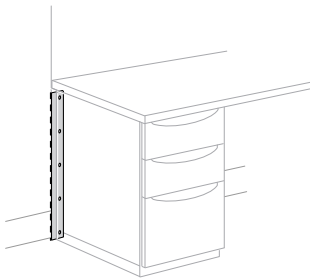

ZEBN-0000
Class CA

Features

- Includes one handed bracket and mounting screws.
- Installs in side trim rail slots and attaches to the back side of an attached pedestal.
- Bracket is predrilled for attachment to pedestal.

To Order, Specify:

- 1) Product number.
- 2) Trim color.

Specification Tips

- Worksurface and pedestal have to be same depth (nominal).
- Not for use with lateral files.
- For use with edgeband worksurfaces.

Description	Height	Depth	Number	Price	
				A	B
Left-hand	2"(51mm)	27.25"(692mm)	ZEBN-0000-PLJ	\$306.30	\$330.31
Right-hand			ZEBN-0000-PRJ	306.30	330.31

Worksurface Supports

Worksurface Support Panels

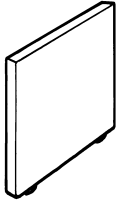

Edgeband



Knife

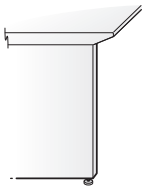

ZEFS
Class CA

Features

- Includes support panel with glides and mounting hardware.
- Installs in panel frame component slots and attaches under the end of a worksurface.
- Provides full support for one end of equal depth worksurfaces.
- Recommended in heavy loading conditions.
- Non-handed design may be installed in left-hand, right-hand or shared configuration.
- High-Pressure Laminate (HPL) or wood surfaces with plastic edge trim, 3mm radiused user edge provides soft access to knee space.
- Adjustable glides provide a maximum of 2.5" (64mm) of height adjustment.

Specification Tips

- Specify worksurface support panel to match worksurface edge option.
- Separately specify Anti-Dislodgement Bracket for additional support. Please refer to Anti-Dislodgement Bracket price list page for specification tips.

To Order, Specify:

- 1) Product number, including:

1 Edge Options:

- J Edgeband
- F Knife

- 2) Laminate color.

- 3) Edge trim color.

Height	Thickness	Depth	Number	1	HPL	
					A	B
27.875"(708mm)	1.5"(38mm)	12"(305mm)	ZEFS-1200-LNE	<input type="checkbox"/>	\$ 512.46	\$555.37
		18"(457mm)	ZEFS-1800-LNE	<input type="checkbox"/>	555.36	595.09
		24"(610mm)	ZEFS-2400-LNE	<input type="checkbox"/>	598.26	634.81
		30"(762mm)	ZEFS-3000-LNE	<input type="checkbox"/>	641.16	674.53

Anti Dislodgement Bracket

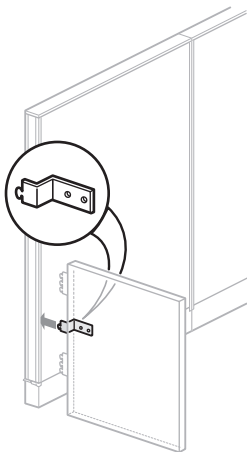

ZEBF-0000-P
Class CA

Features

- Includes one left or right-hand shared or non-shared anti-dislodgement bracket and mounting screws.
- Standard in black finish only.

Specification Tips

- **Anti-Dislodgement Bracket only for use with worksurface support panels used in conjunction with a worksurface.**
- Worksurface support panel with anti-dislodgement bracket can be used in place of a return panel in some applications.
- See Load and Support guidelines for details.

To Order, Specify:

- 1) Product number, including:
(No finish specification required.)

1 Handedness:

- R Right
- L Left

Number	Price
ZEBF-0000-P <input type="checkbox"/>	\$173.56

Worksurface Supports

Straight Leg Basic

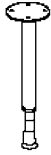

WUCL-0001
Class CA

Features

- Includes one leg and mounting screws.
- 4" (102mm) glide adjustment range allows worksurface heights from 27" (686mm) to 31" (787mm).
- 2.25" (57mm) diameter column includes 6" (152mm)-diameter top plate.
- Standard in Charcoal finish only.
- Shipped assembled.
- Predrilled for convergent worksurfaces and end-of-run worksurface application.

To Order, Specify:

- 1) Product number.
(No finish specification required.)

Number	Price
WUCL-0001	\$308.80

Support Column

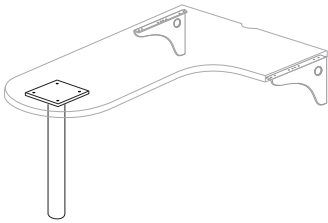

WUCC-0004
Class CA

Features

- Includes one column and mounting screws.
- Column adjusts vertically for worksurface heights from 26" (660mm) to 30" (762mm).
- 3" (76mm)-diameter column includes 6" (152mm)- square top plate.

To Order, Specify:

- 1) Product number.
- 2) Trim color.

Number	Price	
	A	B
WUCC-0004	\$500.23	\$524.71

Worksurface Supports

Double Support Leg

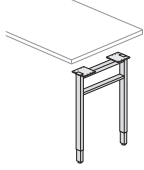

ZZFK
Class CA

Features

- Includes one double leg and mounting hardware.
- Leg may be installed in left-hand or right-hand configuration.
- 6" adjustment range allows worksurface heights from 26"(660mm) to 32"(813mm).
- Provides full support for one end of equal depth worksurface.

Specification Tips

- One end of worksurface must be panel attached, not to be used as freestanding.
- Double leg with glide can be used to replace support post or support column.

To Order, Specify:

- 1) Product number.
- 2) Trim color.

Description	Height (Adjustable)	Number	Price	
			A	B
18"(457mm)	27"(686mm)	ZZFK-1800-PNFG	\$ 966.31	\$992.70
24"(610mm)		ZZFK-2400-PNFG	1017.14	1043.53
30"(762mm)		ZZFK-3000-PNFG	1067.97	1094.36

Single Support Leg

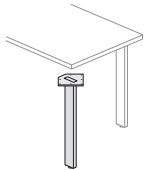

ZUFJ-0101-PNFG
Class CA

Features

- Includes one single post and mounting hardware.
- Glide provides 0.5"(13mm) of height adjustment.

Specification Tips

- May be used for worksurface applications.
- One end of worksurface must be panel attached, not to be used as freestanding.

To Order, Specify:

- 1) Product number.
- 2) Trim color.

Description	Height	Depth	Width	Number	Price	
					A	B
Single Post with Glide	28"(711mm)	3.25"(83mm)	1.125"(29mm)	ZUFJ-0101-PNFG	\$300.17	\$325.82

Support Post

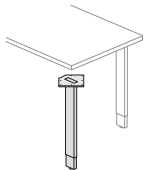

ZZFJ
Class CA

Features

- Includes one single post and mounting hardware.
- 6"(152mm) height adjustment (26"(660mm)-32"(813mm)).

Specification Tip

- May be used for worksurface and freestanding table applications.

To Order, Specify:

- 1) Product number.
- 2) Trim color.

Description	Height (Adjustable)	Number	Price	
			A	B
Single post with glide, adjustable	26"(660mm)/30"(762mm)	ZZFJ-0101-PNFG	\$572.34	\$598.89

Worksurface Supports

Make-A-Corner

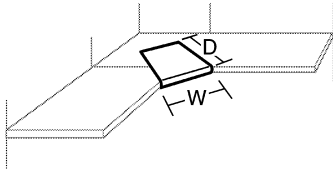

MAC-0001
Class CA

Features

- Creates an angled edge between two (2) perpendicular regular worksurfaces.
- Slides over the top of 1.82"(46mm) thick worksurfaces.
- Accommodates an adjustable keyboard or mouse pad track (screws included).

To Order, Specify:

- 1) Product number.
- 2) Non-metallic trim color.

Height	Width	Number	Price
21.125"(537mm)	26.125"(664mm)	MAC-0001	\$441.09

Adaptable Upper Storage

Straight Mini Shelf, Standard Mount

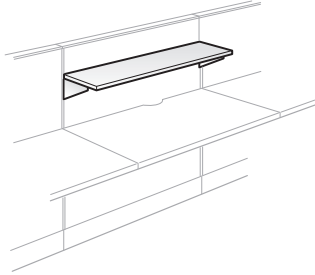

UESY-PM
Class CA

Features

- Includes shelf, brackets, and hardware.
- Shelf thickness is 0.75"(19mm).
- Shipped unassembled.
- To be installed in connector slots on same size panel or on a combination of panels that equals the shelf width.
- Support brackets must be installed under shelf surface.
- Designed for lightweight accessories.
- Does not accept separately specified task lights.

To Order, Specify:

- 1) Product number.
- 2) Laminate shelf color.
- 3) Edgeband trim color.
- 4) Trim color for brackets.

Height	Depth	Width	Number	Laminate		B Trim	
				A Trim	B	A	B
4.25"(108mm)	6.25"(159mm)	18"(457mm)	UESY-0418-PM	\$398.82	\$402.85	\$425.17	\$429.20
		24"(610mm)	UESY-0424-PM	418.34	422.37	448.75	452.78
		30"(762mm)	UESY-0430-PM	437.73	441.76	468.14	472.17
		36"(914mm)	UESY-0436-PM	457.24	461.27	489.68	493.71
		42"(1067mm)	UESY-0442-PM	476.63	480.66	511.10	515.13
		48"(1219mm)	UESY-0448-PM	496.02	500.05	532.52	536.55

Corner Mini Shelf, Standard Mount

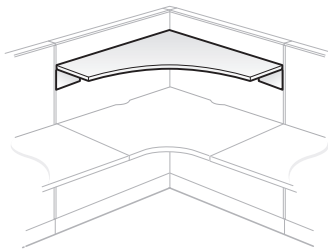

UESZ-PM
Class CA

Features

- Includes shelf, brackets, and hardware.
- Middle of shelf is 15.25"(387mm)D.
- Shelf thickness is 0.75"(19mm).
- Shipped unassembled.

Specification Tips

- To be installed in connector slots on two panels or on a combination of panels of equivalent widths in 90° configuration.
- Support brackets must be installed under shelf surface.
- Designed for lightweight accessories.
- Does not accept separately specified task lights.

To Order, Specify:

- 1) Product number.
- 2) Laminate shelf color.
- 3) Edgeband trim color.
- 4) Trim color for brackets.

Height	Depth	Width	Number	Laminate		B Trim	
				A Trim	B	A	B
4.25"(108mm)	6.25"(159mm)	24"(610mm)	UESZ-0424-PM	\$790.77	\$796.86	\$ 847.55	\$ 853.64
		30"(762mm)	UESZ-0430-PM	841.24	847.33	898.02	904.11
		36"(914mm)	UESZ-0436-PM	891.71	897.80	951.55	957.64
		42"(1067mm)	UESZ-0442-PM	942.18	948.27	1005.08	1011.17
		48"(1219mm)	UESZ-0448-PM	992.65	998.74	1058.61	1064.70

Adaptable Upper Storage

Overhead Storage Unit

Standard Mount

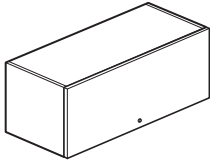

UEFS-PM

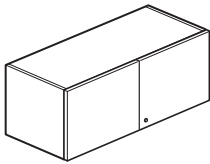

UEKS-PM

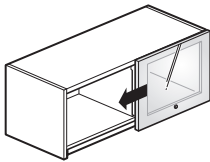

UEHF-QM
Class CA

Features

- Includes door front without lock, top shelf, bottom shelf with back stop, end panels, and hardware. Optional locks available.
- Door available in painted, high-pressure laminate (HPL), translucent or wood.
- Inside dimensions:
–Height: 12.75”(324mm)
–Depth: 13.25”(337mm)
- Locks are available in black or chrome.
- For lock options, refer to Lock Program section of the Accessories Price List.
- Accepts separately specified task lights.
- Safety interlock prevents dislodgement from panel component slots.
- Flipper door stores on top of unit.
- Flipper Door - 66”(1676mm) and 72”(1829mm)W units have two doors, one lock per door if locking option is specified.
- Cabinet Door - 24”(610mm)-42”(1067mm)W units have two cabinet doors with one lock if locking option is specified.
– 48”(1219mm)-72”(1829mm)W units have four cabinet doors with two locks if locking option is specified.
- Single Slider Door - Door is half the width of the unit.
- Shipped unassembled.

Specification Tips

- To be installed in connector slots on same size panel or on a maximum of two panel frames that equal the width of the storage unit.
- Specify separate shelf gang clip for unbalanced configurations with greater than one row of overhead storage units.
- Units cannot be retrofitted with different door style; i.e., flipper doors cannot be changed to cabinet doors.
- Doors cannot be retrofitted with locks.
- Standard mount overhead storage unit cannot be retrofitted to up mount overhead storage unit.
- Cannot be used on top of slat tile.
- Flipper doors can be field retrofitted with slow close mechanism from eParts.

To Order, Specify:

1) Product number, including:

1 Locking Option:

- N** Non-locking
- L** Locking (add **\$33.74** list)

2 Close Option: (Flipper door only)

- S** Slow close 24”(610mm)-60”(1524mm)W units (add **\$552.54** list)
66”(1676mm) and
72”(1829mm)W units (add **\$1105.08** list)

□ No specification required for standard close.

2) Trim color for shelf and end panels.

3) Door surface options:

Painted:

–Trim color

Laminate:

–Laminate surface color
–Edgeband trim color

Translucent:

–Translucent color

Wood:

–Wood finish color

4) Trim color for lock housing (if applicable).

Adaptable Upper Storage

Overhead Storage Unit

Height	Depth	Width	Painted Flipper Door Number ①②	Trim A		Trim B	
				Trim A	B	Trim A	B
Painted							
16"(406mm)	14"(356mm)	24"(610mm)	UEFS-1624-PM	\$ 1175.20	\$ 1181.53	\$ 1192.07	\$ 1198.40
		30"(762mm)	UEFS-1630-PM	1229.38	1236.78	1248.34	1255.74
		36"(914mm)	UEFS-1636-PM	1283.56	1292.03	1304.61	1313.08
		42"(1067mm)	UEFS-1642-PM	1337.74	1347.28	1360.88	1370.42
		48"(1219mm)	UEFS-1648-PM	1391.92	1402.53	1417.15	1427.76
		54"(1372mm)	UEFS-1654-PM	1446.10	1457.78	1473.42	1485.10
		60"(1524mm)	UEFS-1660-PM	1624.69	1637.44	1654.10	1666.85
		66"(1676mm)	UEFS-1666-PM	1955.13	1968.95	1986.63	2000.45
		72"(1829mm)	UEFS-1672-PM	2304.58	2319.47	2338.17	2353.06

Height	Depth	Width	Painted Cabinet Door Number ①	Trim A		Trim B	
				Trim A	B	Trim A	B
16"(406mm)	14"(356mm)	24"(610mm)	UEKS-1624-PM	\$ 1958.24	\$ 1964.57	\$ 1975.11	\$ 1981.44
		30"(762mm)	UEKS-1630-PM	2012.42	2019.82	2031.38	2038.78
		36"(914mm)	UEKS-1636-PM	2066.60	2075.07	2087.65	2096.12
		42"(1067mm)	UEKS-1642-PM	2120.78	2130.32	2143.92	2153.46
		48"(1219mm)	UEKS-1648-PM	2250.25	2260.86	2275.48	2286.09
		54"(1372mm)	UEKS-1654-PM	2446.36	2458.04	2473.68	2485.36
		60"(1524mm)	UEKS-1660-PM	2673.42	2686.17	2702.83	2715.58
		66"(1676mm)	UEKS-1666-PM	3225.33	3239.15	3256.83	3270.65
		72"(1829mm)	UEKS-1672-PM	3722.43	3737.32	3756.02	3770.91

Height	Depth	Width	Painted Single Slider Door Number ①	Trim A		Trim B	
				Trim A	B	Trim A	B
16"(406mm)	14"(356mm)	24"(610mm)	UEHS-1624-PM	\$ 1175.20	\$ 1181.53	\$ 1192.07	\$ 1198.40
		30"(762mm)	UEHS-1630-PM	1229.38	1236.78	1248.34	1255.74
		36"(914mm)	UEHS-1636-PM	1283.56	1292.03	1304.61	1313.08
		42"(1067mm)	UEHS-1642-PM	1337.74	1347.28	1360.88	1370.42
		48"(1219mm)	UEHS-1648-PM	1391.92	1402.53	1417.15	1427.76
		54"(1372mm)	UEHS-1654-PM	1446.10	1457.78	1473.42	1485.10
		60"(1524mm)	UEHS-1660-PM	1624.69	1637.44	1654.10	1666.85
		66"(1676mm)	UEHS-1666-PM	1955.13	1968.95	1986.63	2000.45
		72"(1829mm)	UEHS-1672-PM	2304.58	2319.47	2338.17	2353.06

Adaptable Upper Storage

Overhead Storage Unit

Height	Depth	Width	Laminate Flipper Door Number ①②	HPL A Trim		HPL B Trim	
				A	B	A	B
Laminate							
16"(406mm)	14"(356mm)	24"(610mm)	UEFS-1624-LM	\$ 1597.17	\$ 1614.04	\$ 1628.83	\$ 1645.70
		30"(762mm)	UEFS-1630-LM	1691.22	1710.18	1722.88	1741.84
		36"(914mm)	UEFS-1636-LM	1785.27	1806.32	1816.93	1837.98
		42"(1067mm)	UEFS-1642-LM	1879.32	1902.46	1910.98	1934.12
		48"(1219mm)	UEFS-1648-LM	1973.37	1998.60	2005.03	2030.26
		54"(1372mm)	UEFS-1654-LM	2067.42	2094.74	2099.08	2126.40
		60"(1524mm)	UEFS-1660-LM	2290.14	2319.55	2321.80	2351.21
		66"(1676mm)	UEFS-1666-LM	2776.38	2807.88	2808.04	2839.54
		72"(1829mm)	UEFS-1672-LM	3264.83	3298.42	3296.49	3330.08

Height	Depth	Width	Laminate Cabinet Door Number ①	HPL A Trim		HPL B Trim	
				A	B	A	B
16"(406mm)	14"(356mm)	24"(610mm)	UEKS-1624-LM	\$ 2718.67	\$ 2735.54	\$ 2750.33	\$ 2767.20
		30"(762mm)	UEKS-1630-LM	2812.72	2831.68	2844.38	2863.34
		36"(914mm)	UEKS-1636-LM	2906.77	2927.82	2938.43	2959.48
		42"(1067mm)	UEKS-1642-LM	3000.82	3023.96	3032.48	3055.62
		48"(1219mm)	UEKS-1648-LM	3135.46	3160.69	3167.12	3192.35
		54"(1372mm)	UEKS-1654-LM	3439.88	3467.20	3471.54	3498.86
		60"(1524mm)	UEKS-1660-LM	3765.92	3795.33	3797.58	3826.99
		66"(1676mm)	UEKS-1666-LM	4505.25	4536.75	4536.91	4568.41
		72"(1829mm)	UEKS-1672-LM	5240.47	5274.06	5272.13	5305.72

Height	Depth	Width	Laminate Single Slider Door Number ①	HPL A Trim		HPL B Trim	
				A	B	A	B
16"(406mm)	14"(356mm)	24"(610mm)	UEHS-1624-LM	\$ 1597.17	\$ 1614.04	\$ 1628.83	\$ 1645.70
		30"(762mm)	UEHS-1630-LM	1691.22	1710.18	1722.88	1741.84
		36"(914mm)	UEHS-1636-LM	1785.27	1806.32	1816.93	1837.98
		42"(1067mm)	UEHS-1642-LM	1879.32	1902.46	1910.98	1934.12
		48"(1219mm)	UEHS-1648-LM	1973.37	1998.60	2005.03	2030.26
		54"(1372mm)	UEHS-1654-LM	2067.42	2094.74	2099.08	2126.40
		60"(1524mm)	UEHS-1660-LM	2290.14	2319.55	2321.80	2351.21
		66"(1676mm)	UEHS-1666-LM	2776.38	2807.88	2808.04	2839.54
		72"(1829mm)	UEHS-1672-LM	3264.83	3298.42	3296.49	3330.08

Adaptable Upper Storage Overhead Storage Unit

Height	Depth	Width	Translucent Flipper Door	Trim	
			Number ①②	A	B
Translucent					
16"(406mm)	14"(356mm)	24"(610mm)	UEFF-1624-QM	\$ 1841.36	\$ 1858.23
		30"(762mm)	UEFF-1630-QM	1922.63	1941.59
		36"(914mm)	UEFF-1636-QM	2003.90	2024.95
		42"(1067mm)	UEFF-1642-QM	2085.17	2108.31
		48"(1219mm)	UEFF-1648-QM	2166.44	2191.67
		54"(1372mm)	UEFF-1654-QM	2247.71	2275.03
		60"(1524mm)	UEFF-1660-QM	2512.45	2541.86
		66"(1676mm)	UEFF-1666-QM	3076.63	3108.13
		72"(1829mm)	UEFF-1672-QM	3501.70	3535.29

Height	Depth	Width	Translucent Cabinet Door	Trim	
			Number ①	A	B
16"(406mm)	14"(356mm)	24"(610mm)	UEKF-1624-QM	\$2962.86	\$ 2979.73
		30"(762mm)	UEKF-1630-QM	3075.69	3094.65
		36"(914mm)	UEKF-1636-QM	3188.52	3209.57
		42"(1067mm)	UEKF-1642-QM	3301.35	3324.49
		48"(1219mm)	UEKF-1648-QM	3451.80	3477.03
		54"(1372mm)	UEKF-1654-QM	3769.56	3796.88
		60"(1524mm)	UEKF-1660-QM	4106.74	4136.15
		66"(1676mm)	UEKF-1666-QM	4934.96	4966.46
		72"(1829mm)	UEKF-1672-QM	5696.08	5729.67

Height	Depth	Width	Translucent Single Slider Door	Trim	
			Number ①	A	B
16"(406mm)	14"(356mm)	24"(610mm)	UEHF-1624-QM	\$ 1841.36	\$ 1858.23
		30"(762mm)	UEHF-1630-QM	1922.63	1941.59
		36"(914mm)	UEHF-1636-QM	2003.90	2024.95
		42"(1067mm)	UEHF-1642-QM	2085.17	2108.31
		48"(1219mm)	UEHF-1648-QM	2166.44	2191.67
		54"(1372mm)	UEHF-1654-QM	2247.71	2275.03
		60"(1524mm)	UEHF-1660-QM	2512.45	2541.86
		66"(1676mm)	UEHF-1666-QM	3076.63	3108.13
		72"(1829mm)	UEHF-1672-QM	3501.70	3535.29

Adaptable Upper Storage

Overhead Storage Unit

Height	Depth	Width	Wood Flipper Door Number ①②	Wood A Trim		Wood B Trim	
				A	B	A	B
Wood							
16"(406mm)	14"(356mm)	24"(610mm)	UEFS-1624-WM ■■	\$ 2186.23	\$2203.10	\$2308.54	\$ 2325.41
		30"(762mm)	UEFS-1630-WM ■■	2273.71	2292.67	2396.02	2414.98
		36"(914mm)	UEFS-1636-WM ■■	2361.19	2382.24	2483.50	2504.55
		42"(1067mm)	UEFS-1642-WM ■■	2448.67	2471.81	2570.98	2594.12
		48"(1219mm)	UEFS-1648-WM ■■	2536.15	2561.38	2658.46	2683.69
		54"(1372mm)	UEFS-1654-WM ■■	2623.63	2650.95	2745.94	2773.26
		60"(1524mm)	UEFS-1660-WM ■■	2968.38	2997.79	3090.69	3120.10
		66"(1676mm)	UEFS-1666-WM ■■	3490.30	3521.80	3612.61	3644.11
		72"(1829mm)	UEFS-1672-WM ■■	4054.43	4088.02	4176.74	4210.33

Height	Depth	Width	Wood Cabinet Door Number ①	Wood A Trim		Wood B Trim	
				A	B	A	B
16"(406mm)	14"(356mm)	24"(610mm)	UEKS-1624-WM ■	\$3402.50	\$ 3419.37	\$3524.81	\$ 3541.68
		30"(762mm)	UEKS-1630-WM ■	3502.70	3521.66	3625.01	3643.97
		36"(914mm)	UEKS-1636-WM ■	3602.90	3623.95	3725.21	3746.26
		42"(1067mm)	UEKS-1642-WM ■	3703.10	3726.24	3825.41	3848.55
		48"(1219mm)	UEKS-1648-WM ■	3843.11	3868.34	3965.42	3990.65
		54"(1372mm)	UEKS-1654-WM ■	4190.31	4217.63	4312.62	4339.94
		60"(1524mm)	UEKS-1660-WM ■	4559.95	4589.36	4682.26	4711.67
		66"(1676mm)	UEKS-1666-WM ■	5405.07	5436.57	5527.38	5558.88
		72"(1829mm)	UEKS-1672-WM ■	6243.47	6277.06	6365.78	6399.37

Height	Depth	Width	Wood Single Slider Door Number ①	Wood A Trim		Wood B Trim	
				A	B	A	B
16"(406mm)	14"(356mm)	24"(610mm)	UEHS-1624-WM ■	\$ 2186.23	\$2203.10	\$2308.54	\$ 2325.41
		30"(762mm)	UEHS-1630-WM ■	2273.71	2292.67	2396.02	2414.98
		36"(914mm)	UEHS-1636-WM ■	2361.19	2382.24	2483.50	2504.55
		42"(1067mm)	UEHS-1642-WM ■	2448.67	2471.81	2570.98	2594.12
		48"(1219mm)	UEHS-1648-WM ■	2536.15	2561.38	2658.46	2683.69
		54"(1372mm)	UEHS-1654-WM ■	2623.63	2650.95	2745.94	2773.26
		60"(1524mm)	UEHS-1660-WM ■	2968.38	2997.79	3090.69	3120.10
		66"(1676mm)	UEHS-1666-WM ■	3490.30	3521.80	3612.61	3644.11
		72"(1829mm)	UEHS-1672-WM ■	4054.43	4088.02	4176.74	4210.33

Adaptable Upper Storage Overhead Storage Unit

Up Mount

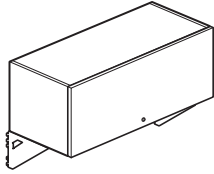

UEGS-PM

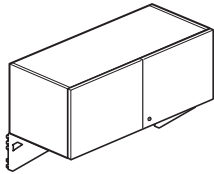

UELS-PM

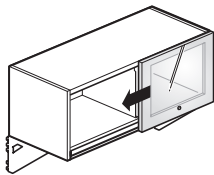

UEJS-PM
Class CA

Features

- Includes door front without lock, top shelf, bottom shelf with full back, end panels, mounting brackets and hardware. Optional locks available.
- Door available in painted, high-pressure laminate (HPL), translucent or wood.
- Inside dimensions:
–Height: 12.75”(324mm)
–Depth: 13.25”(337mm)
- Up-Mount brackets are color-matched to case.
- Locks are available in black or chrome.
- For lock options, refer to Lock Program section of the Accessories Price List.
- Accepts separately specified task lights.
- Safety interlock prevents dislodgement from panel component slots.
- Flipper door stores on top of unit.
- Cabinet Door - 24”(610mm)-42”(1067mm)W units have two cabinet doors with one lock if locking option is specified.
– 48”(1219mm)W units have four cabinet doors with two locks if locking option is specified.
- Single Slider Door - Door is half the width of the unit.
- Doors shipped separate - ships unassembled.

Specification Tips

- To be installed in connector slots on same size panel or on a maximum of two panel frames that equal the width of the storage unit.
- Specify separate shelf gang clip for unbalanced configurations with greater than one row of overhead storage units.
- Doors cannot be retrofitted with locks.
- Up-mount overhead storage unit cannot be retrofitted to standard mount overhead storage unit.
- Recommended for single row application.
- Recommended for use with 50”(1270mm) or 58”(1473mm)H panel configurations.
- Using up mount overheads limits allowable panel runs to 8 feet maximum and requires worksurfaces use side-mount brackets, worksurface support panels or other form of floor support. (Fully cantilevered worksurfaces are not allowed). Return panels on each end must equal height of panel run and depth of worksurface.
- Flipper doors can be field retrofitted with slow close mechanism from eParts.

To Order, Specify:

1) Product number, including:

1 Locking Option:

- N** Non-locking
- L** Locking (add **\$33.74** list)

2 Close Option: (Flipper door only)

- S** Slow close (add **\$552.54** list)
- No specification required for standard close.

2) Trim color for shelf and end panels.

3) Door surface options:

Painted:

- Trim color

Laminate:

- Laminate surface color
- Edgeband trim color

Translucent:

- Translucent color

Wood:

- Wood finish color

4) Trim color for lock housing (if applicable).

Adaptable Upper Storage

Overhead Storage Unit

Height	Depth	Width	Painted Flipper Door Number ①②	Trim A		Trim B	
				Trim A	B	Trim A	B
Painted							
16"(406mm)	14"(356mm)	24"(610mm)	UEGS-1624-PM ■ ■	\$1642.47	\$1648.80	\$1659.34	\$1665.67
		30"(762mm)	UEGS-1630-PM ■ ■	1696.65	1704.05	1715.61	1723.01
		36"(914mm)	UEGS-1636-PM ■ ■	1750.83	1759.30	1771.88	1780.35
		42"(1067mm)	UEGS-1642-PM ■ ■	1805.01	1814.55	1828.15	1837.69
		48"(1219mm)	UEGS-1648-PM ■ ■	1859.19	1869.80	1884.42	1895.03

Height	Depth	Width	Painted Cabinet Door Number ①	Trim A		Trim B	
				Trim A	B	Trim A	B
16"(406mm)	14"(356mm)	24"(610mm)	UELS-1624-PM ■	\$2775.38	\$2781.71	\$2792.25	\$2798.58
		30"(762mm)	UELS-1630-PM ■	2829.56	2836.96	2848.52	2855.92
		36"(914mm)	UELS-1636-PM ■	2883.74	2892.21	2904.79	2913.26
		42"(1067mm)	UELS-1642-PM ■	2937.92	2947.46	2961.06	2970.60
		48"(1219mm)	UELS-1648-PM ■	3067.39	3078.00	3092.62	3103.23

Height	Depth	Width	Painted Single Slider Door Number ①	Trim A		Trim B	
				Trim A	B	Trim A	B
16"(406mm)	14"(356mm)	24"(610mm)	UEJS-1624-PM ■	\$1642.47	\$1648.80	\$1659.34	\$1665.67
		30"(762mm)	UEJS-1630-PM ■	1696.65	1704.05	1715.61	1723.01
		36"(914mm)	UEJS-1636-PM ■	1750.83	1759.30	1771.88	1780.35
		42"(1067mm)	UEJS-1642-PM ■	1805.01	1814.55	1828.15	1837.69
		48"(1219mm)	UEJS-1648-PM ■	1859.19	1869.80	1884.42	1895.03

Adaptable Upper Storage

Overhead Storage Unit

Height	Depth	Width	Laminate Flipper Door Number ①②	HPL A Trim		HPL B Trim	
				A	B	A	B
Laminate							
16"(406mm)	14"(356mm)	24"(610mm)	UEGS-1624-LM	\$2268.16	\$2285.03	\$2299.82	\$ 2316.69
		30"(762mm)	UEGS-1630-LM	2362.21	2381.17	2393.87	2412.83
		36"(914mm)	UEGS-1636-LM	2456.26	2477.31	2487.92	2508.97
		42"(1067mm)	UEGS-1642-LM	2550.31	2573.45	2581.97	2605.11
		48"(1219mm)	UEGS-1648-LM	2644.36	2669.59	2676.02	2701.25

Height	Depth	Width	Laminate Cabinet Door Number ①	HPL A Trim		HPL B Trim	
				A	B	A	B
16"(406mm)	14"(356mm)	24"(610mm)	UELS-1624-LM	\$ 3887.89	\$3904.76	\$ 3919.55	\$3936.42
		30"(762mm)	UELS-1630-LM	3981.94	4000.90	4013.60	4032.56
		36"(914mm)	UELS-1636-LM	4075.99	4097.04	4107.65	4128.70
		42"(1067mm)	UELS-1642-LM	4170.04	4193.18	4201.70	4224.84
		48"(1219mm)	UELS-1648-LM	4304.68	4329.91	4336.34	4361.57

Height	Depth	Width	Laminate Single Slider Door Number ①	HPL A Trim		HPL B Trim	
				A	B	A	B
16"(406mm)	14"(356mm)	24"(610mm)	UEJS-1624-LM	\$2268.16	\$2285.03	\$2299.82	\$ 2316.69
		30"(762mm)	UEJS-1630-LM	2362.21	2381.17	2393.87	2412.83
		36"(914mm)	UEJS-1636-LM	2456.26	2477.31	2487.92	2508.97
		42"(1067mm)	UEJS-1642-LM	2550.31	2573.45	2581.97	2605.11
		48"(1219mm)	UEJS-1648-LM	2644.36	2669.59	2676.02	2701.25

Adaptable Upper Storage Overhead Storage Unit

Height	Depth	Width	Translucent Flipper Door	Trim	
			Number ①②	A	B
Translucent					
16"(406mm)	14"(356mm)	24"(610mm)	UEGF-1624-QM ■■	\$2576.52	\$2593.39
		30"(762mm)	UEGF-1630-QM ■■	2657.79	2676.75
		36"(914mm)	UEGF-1636-QM ■■	2739.06	2760.11
		42"(1067mm)	UEGF-1642-QM ■■	2820.33	2843.47
		48"(1219mm)	UEGF-1648-QM ■■	2901.60	2926.83

Height	Depth	Width	Translucent Cabinet Door	Trim	
			Number ①	A	B
16"(406mm)	14"(356mm)	24"(610mm)	UELF-1624-QM ■	\$4225.05	\$4241.92
		30"(762mm)	UELF-1630-QM ■	4337.88	4356.84
		36"(914mm)	UELF-1636-QM ■	4450.71	4471.76
		42"(1067mm)	UELF-1642-QM ■	4563.54	4586.68
		48"(1219mm)	UELF-1648-QM ■	4713.99	4739.22

Height	Depth	Width	Translucent Single Slider Door	Trim	
			Number ①	A	B
16"(406mm)	14"(356mm)	24"(610mm)	UEJF-1624-QM ■	\$2576.52	\$2593.39
		30"(762mm)	UEJF-1630-QM ■	2657.79	2676.75
		36"(914mm)	UEJF-1636-QM ■	2739.06	2760.11
		42"(1067mm)	UEJF-1642-QM ■	2820.33	2843.47
		48"(1219mm)	UEJF-1648-QM ■	2901.60	2926.83

Adaptable Upper Storage

Overhead Storage Unit

Height	Depth	Width	Wood Flipper Door Number ①②	Wood A Trim		Wood B Trim	
				A	B	A	B
Wood							
16"(406mm)	14"(356mm)	24"(610mm)	UEGS-1624-WM	\$2888.20	\$2905.07	\$3010.51	\$3027.38
		30"(762mm)	UEGS-1630-WM	2975.68	2994.64	3097.99	3116.95
		36"(914mm)	UEGS-1636-WM	3063.16	3084.21	3185.47	3206.52
		42"(1067mm)	UEGS-1642-WM	3150.64	3173.78	3272.95	3296.09
		48"(1219mm)	UEGS-1648-WM	3238.12	3263.35	3360.43	3385.66

Height	Depth	Width	Wood Cabinet Door Number ①	Wood A Trim		Wood B Trim	
				A	B	A	B
16"(406mm)	14"(356mm)	24"(610mm)	UELS-1624-WM	\$4735.53	\$4752.40	\$4857.84	\$4874.71
		30"(762mm)	UELS-1630-WM	4835.73	4854.69	4958.04	4977.00
		36"(914mm)	UELS-1636-WM	4935.93	4956.98	5058.24	5079.29
		42"(1067mm)	UELS-1642-WM	5036.13	5059.27	5158.44	5181.58
		48"(1219mm)	UELS-1648-WM	5176.14	5201.37	5298.45	5323.68

Height	Depth	Width	Wood Single Slider Door Number ①	Wood A Trim		Wood B Trim	
				A	B	A	B
16"(406mm)	14"(356mm)	24"(610mm)	UEJS-1624-WM	\$2888.20	\$2905.07	\$3010.51	\$3027.38
		30"(762mm)	UEJS-1630-WM	2975.68	2994.64	3097.99	3116.95
		36"(914mm)	UEJS-1636-WM	3063.16	3084.21	3185.47	3206.52
		42"(1067mm)	UEJS-1642-WM	3150.64	3173.78	3272.95	3296.09
		48"(1219mm)	UEJS-1648-WM	3238.12	3263.35	3360.43	3385.66

Adaptable Upper Storage

Open Shelf Standard Mount

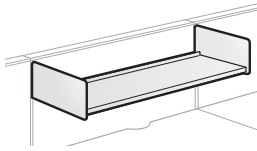

UESN
Class CA

Features

- Includes shelf with back stop, end panels and hardware.
- Accepts separately specified task lights.
- Safety interlock prevents dislodgment from panel connector slots.
- Shelf thickness is 2"(51mm).
- Shipped unassembled.

Specification Tips

- Specify separate shelf gang clip for unbalanced configurations with greater than one row of shelves.
- To be installed in component mounting rails on same size panel or on a maximum of two panel frames that equals the shelf width.

To Order, Specify:

- 1) Product number.
- 2) Trim color.

Height	Depth	Width	Number	Trim	
				A	B
8"(203mm)	14"(356mm)	24"(610mm)	UESN-0824-PM	\$398.97	\$ 418.97
		30"(762mm)	UESN-0830-PM	413.22	438.20
		36"(914mm)	UESN-0836-PM	427.47	457.43
		42"(1067mm)	UESN-0842-PM	441.72	476.66
		48"(1219mm)	UESN-0848-PM	455.97	495.89
		54"(1372mm)	UESN-0854-PM	470.22	515.12
		60"(1524mm)	UESN-0860-PM	484.47	534.35
		66"(1676mm)	UESN-0866-PM	498.72	553.58
		72"(1829mm)	UESN-0872-PM	512.97	572.81

Shelf Divider

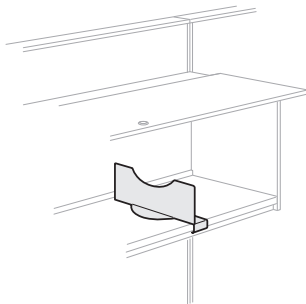

NADR-8
Class CA

Features

- To be used to divide space laterally on overhead storage units and open shelves.
- Includes box of eight shelf dividers.
- May be used on all Compose shelves or standard mount or up-mount overhead storage units.

To Order, Specify:

- 1) Product number.
- 2) Trim color.

Height	Depth	Width	Number	Trim	
				A	B
4"(102mm)	13.25"(337mm)	1.75"(44mm)	NADR-8	\$477.08	\$502.89

Overhead Storage Unit / Shelf Gang Clip

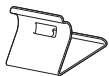

NUB-1
Class CA

Features

- Includes one ganging clip.
- Provides additional stability in unbalanced panel configurations with adjacent shelves and overheads.
- Required for all adjacent shelves and unbalanced panel configurations.
- Standard in black finish.

To Order, Specify:

- 1) Product number.
(No finish specification required.)

Number	Price
NUB-1	\$81.78

Wall Mount Components

Overhead Storage Unit

Wall Mount

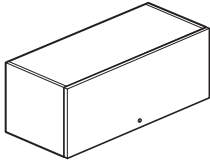

UUFS-PW

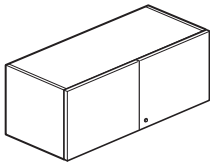

UUKS-PW

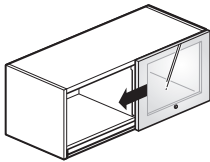

UUHF-QW
Class CA

Features

- Includes door front with lock option, top shelf, bottom shelf with back stop, end panels, mounting bar and hardware. Optional locks and non-structural back are available.
- Door available in painted, high-pressure laminate (HPL), translucent or wood.
- Inside dimensions:
–Height: 12.75”(324mm)
–Depth: 13.25”(337mm)
- Locks are available in black or chrome.
- For lock options, refer to Lock Program section of the Accessories Price List.
- Accepts separately specified task lights.
- Safety interlock prevents dislodgement from wall.
- Flipper Door - 66”(1676mm) and 72”(1829mm)W units have two doors, one lock per door if locking option is specified.
- Flipper door stores on top of unit.
- Cabinet Door - 24”(610mm)-42”(1067mm)W units have two cabinet doors with one lock if locking option is specified.
– 48”(1219mm)-72”(1829mm)W units have four cabinet doors with two locks if locking option is specified.
- Single Slider Door - Door is half the width of the unit.
- Shipped unassembled.

Specification Tips

- Doors cannot be retrofitted with locks.
- Must be properly anchored to a structural wall.
- Anchors are not provided, must be field supplied.
- Flipper doors can be field retrofitted with slow close mechanism from eParts.

To Order, Specify:

1) Product number, including:

1 Locking Option:

- N** Non-locking
- L** Locking (add **\$33.74** list)

2 Close Option: (Flipper door only)

- S** Slow close 24”(610mm)-60”(1524mm)W units (add **\$552.54** list)
66”(1676mm) and 72”(1829mm)W units (add **\$1105.08** list)

□ No specification required for standard close.

2) Trim color for shelf and end panels.

3) Door surface options:

Painted:

–Trim color

Laminate:

–Laminate surface color
–Edgeband trim color

Translucent:

–Translucent color

Wood:

–Wood finish color

4) Trim color for lock housing (if applicable).

Wall Mount Components

Overhead Storage Unit

Height	Depth	Width	Painted Flipper Door Number ①②	Trim A		Trim B	
				Trim A	B	Trim A	B
Painted							
16"(406mm)	14"(356mm)	24"(610mm)	UUFS-1624-PW	\$ 1265.97	\$ 1272.30	\$ 1282.84	\$ 1289.17
		30"(762mm)	UUFS-1630-PW	1320.15	1327.55	1339.11	1346.51
		36"(914mm)	UUFS-1636-PW	1374.33	1382.80	1395.38	1403.85
		42"(1067mm)	UUFS-1642-PW	1428.51	1438.05	1451.65	1461.19
		48"(1219mm)	UUFS-1648-PW	1482.69	1493.30	1507.92	1518.53
		54"(1372mm)	UUFS-1654-PW	1536.87	1548.55	1564.19	1575.87
		60"(1524mm)	UUFS-1660-PW	1715.46	1728.21	1744.87	1757.62
		66"(1676mm)	UUFS-1666-PW	2045.90	2059.72	2077.40	2091.22
		72"(1829mm)	UUFS-1672-PW	2395.35	2410.24	2428.94	2443.83

Height	Depth	Width	Painted Cabinet Door Number ①	Trim A		Trim B	
				Trim A	B	Trim A	B
16"(406mm)	14"(356mm)	24"(610mm)	UUKS-1624-PW	\$2049.01	\$2055.34	\$2065.88	\$2072.21
		30"(762mm)	UUKS-1630-PW	2103.19	2110.59	2122.15	2129.55
		36"(914mm)	UUKS-1636-PW	2157.37	2165.84	2178.42	2186.89
		42"(1067mm)	UUKS-1642-PW	2211.55	2221.09	2234.69	2244.23
		48"(1219mm)	UUKS-1648-PW	2341.02	2351.63	2366.25	2376.86
		54"(1372mm)	UUKS-1654-PW	2537.13	2548.81	2564.45	2576.13
		60"(1524mm)	UUKS-1660-PW	2764.19	2776.94	2793.60	2806.35
		66"(1676mm)	UUKS-1666-PW	3316.10	3329.92	3347.60	3361.42
		72"(1829mm)	UUKS-1672-PW	3813.20	3828.09	3846.79	3861.68

Height	Depth	Width	Painted Single Slider Door Number ①	Trim A		Trim B	
				Trim A	B	Trim A	B
16"(406mm)	14"(356mm)	24"(610mm)	UUHS-1624-PW	\$ 1265.97	\$ 1272.30	\$ 1282.84	\$ 1289.17
		30"(762mm)	UUHS-1630-PW	1320.15	1327.55	1339.11	1346.51
		36"(914mm)	UUHS-1636-PW	1374.33	1382.80	1395.38	1403.85
		42"(1067mm)	UUHS-1642-PW	1428.51	1438.05	1451.65	1461.19
		48"(1219mm)	UUHS-1648-PW	1482.69	1493.30	1507.92	1518.53
		54"(1372mm)	UUHS-1654-PW	1536.87	1548.55	1564.19	1575.87
		60"(1524mm)	UUHS-1660-PW	1715.46	1728.21	1744.87	1757.62
		66"(1676mm)	UUHS-1666-PW	2045.90	2059.72	2077.40	2091.22
		72"(1829mm)	UUHS-1672-PW	2395.35	2410.24	2428.94	2443.83

Wall Mount Components

Overhead Storage Unit









Height	Depth	Width	Laminate Flipper Door Number ①②	HPL A Trim		HPL B Trim	
				A	B	A	B
Laminate							
16"(406mm)	14"(356mm)	24"(610mm)	UUFS-1624-LW	\$ 1896.15	\$ 1913.02	\$ 1927.81	\$ 1944.68
		30"(762mm)	UUFS-1630-LW	1990.20	2009.16	2021.86	2040.82
		36"(914mm)	UUFS-1636-LW	2084.25	2105.30	2115.91	2136.96
		42"(1067mm)	UUFS-1642-LW	2178.30	2201.44	2209.96	2233.10
		48"(1219mm)	UUFS-1648-LW	2272.35	2297.58	2304.01	2329.24
		54"(1372mm)	UUFS-1654-LW	2366.40	2393.72	2398.06	2425.38
		60"(1524mm)	UUFS-1660-LW	2589.12	2618.53	2620.78	2650.19
		66"(1676mm)	UUFS-1666-LW	3075.36	3106.86	3107.02	3138.52
		72"(1829mm)	UUFS-1672-LW	3563.81	3597.40	3595.47	3629.06









Height	Depth	Width	Laminate Cabinet Door Number ①	HPL A Trim		HPL B Trim	
				A	B	A	B
16"(406mm)	14"(356mm)	24"(610mm)	UUKS-1624-LW	\$ 3017.65	\$3034.52	\$3049.31	\$3066.18
		30"(762mm)	UUKS-1630-LW	3111.70	3130.66	3143.36	3162.32
		36"(914mm)	UUKS-1636-LW	3205.75	3226.80	3237.41	3258.46
		42"(1067mm)	UUKS-1642-LW	3299.80	3322.94	3331.46	3354.60
		48"(1219mm)	UUKS-1648-LW	3434.44	3459.67	3466.10	3491.33
		54"(1372mm)	UUKS-1654-LW	3738.86	3766.18	3770.52	3797.84
		60"(1524mm)	UUKS-1660-LW	4064.90	4094.31	4096.56	4125.97
		66"(1676mm)	UUKS-1666-LW	4804.23	4835.73	4835.89	4867.39
		72"(1829mm)	UUKS-1672-LW	5539.45	5573.04	5571.11	5604.70









Height	Depth	Width	Laminate Single Slider Door Number ①	HPL A Trim		HPL B Trim	
				A	B	A	B
16"(406mm)	14"(356mm)	24"(610mm)	UUHS-1624-LW	\$ 1896.15	\$ 1913.02	\$ 1927.81	\$ 1944.68
		30"(762mm)	UUHS-1630-LW	1990.20	2009.16	2021.86	2040.82
		36"(914mm)	UUHS-1636-LW	2084.25	2105.30	2115.91	2136.96
		42"(1067mm)	UUHS-1642-LW	2178.30	2201.44	2209.96	2233.10
		48"(1219mm)	UUHS-1648-LW	2272.35	2297.58	2304.01	2329.24
		54"(1372mm)	UUHS-1654-LW	2366.40	2393.72	2398.06	2425.38
		60"(1524mm)	UUHS-1660-LW	2589.12	2618.53	2620.78	2650.19
		66"(1676mm)	UUHS-1666-LW	3075.36	3106.86	3107.02	3138.52
		72"(1829mm)	UUHS-1672-LW	3563.81	3597.40	3595.47	3629.06

Wall Mount Components

Overhead Storage Unit

Height	Depth	Width	Translucent	Trim	
			Flipper Door Number ①②	A	B
16"(406mm)	14"(356mm)	24"(610mm)	UUFF-1624-QW 	\$ 2237.83	\$ 2254.70
		30"(762mm)	UUFF-1630-QW 	2319.10	2338.06
		36"(914mm)	UUFF-1636-QW 	2400.37	2421.42
		42"(1067mm)	UUFF-1642-QW 	2481.64	2504.78
		48"(1219mm)	UUFF-1648-QW 	2562.91	2588.14
		54"(1372mm)	UUFF-1654-QW 	2644.18	2671.50
		60"(1524mm)	UUFF-1660-QW 	2908.92	2938.33
		66"(1676mm)	UUFF-1666-QW 	3473.10	3504.60
		72"(1829mm)	UUFF-1672-QW 	3898.17	3931.76

Height	Depth	Width	Translucent	Trim	
			Cabinet Door Number ①	A	B
16"(406mm)	14"(356mm)	24"(610mm)	UUKF-1624-QW 	\$ 3359.33	\$ 3376.20
		30"(762mm)	UUKF-1630-QW 	3472.16	3491.12
		36"(914mm)	UUKF-1636-QW 	3584.99	3606.04
		42"(1067mm)	UUKF-1642-QW 	3697.82	3720.96
		48"(1219mm)	UUKF-1648-QW 	3848.27	3873.50
		54"(1372mm)	UUKF-1654-QW 	4166.03	4193.35
		60"(1524mm)	UUKF-1660-QW 	4503.21	4532.62
		66"(1676mm)	UUKF-1666-QW 	5331.43	5362.93
		72"(1829mm)	UUKF-1672-QW 	6092.55	6126.14

Height	Depth	Width	Translucent	Trim	
			Single Slider Door Number ①	A	B
16"(406mm)	14"(356mm)	24"(610mm)	UUHF-1624-QW 	\$ 2237.83	\$ 2254.70
		30"(762mm)	UUHF-1630-QW 	2319.10	2338.06
		36"(914mm)	UUHF-1636-QW 	2400.37	2421.42
		42"(1067mm)	UUHF-1642-QW 	2481.64	2504.78
		48"(1219mm)	UUHF-1648-QW 	2562.91	2588.14
		54"(1372mm)	UUHF-1654-QW 	2644.18	2671.50
		60"(1524mm)	UUHF-1660-QW 	2908.92	2938.33
		66"(1676mm)	UUHF-1666-QW 	3473.10	3504.60
		72"(1829mm)	UUHF-1672-QW 	3898.17	3931.76

Wall Mount Components

Overhead Storage Unit

Height	Depth	Width	Wood Flipper Door Number ①②	Wood A Trim		Wood B Trim	
				A	B	A	B
Wood							
16"(406mm)	14"(356mm)	24"(610mm)	UUFS-1624-WW	\$2460.37	\$ 2477.24	\$2582.68	\$2599.55
		30"(762mm)	UUFS-1630-WW	2547.85	2566.81	2670.16	2689.12
		36"(914mm)	UUFS-1636-WW	2635.33	2656.38	2757.64	2778.69
		42"(1067mm)	UUFS-1642-WW	2722.81	2745.95	2845.12	2868.26
		48"(1219mm)	UUFS-1648-WW	2810.29	2835.52	2932.60	2957.83
		54"(1372mm)	UUFS-1654-WW	2897.77	2925.09	3020.08	3047.40
		60"(1524mm)	UUFS-1660-WW	3242.52	3271.93	3364.83	3394.24
		66"(1676mm)	UUFS-1666-WW	3764.44	3795.94	3886.75	3918.25
		72"(1829mm)	UUFS-1672-WW	4328.57	4362.16	4450.88	4484.47

Height	Depth	Width	Wood Cabinet Door Number ①	Wood A Trim		Wood B Trim	
				A	B	A	B
16"(406mm)	14"(356mm)	24"(610mm)	UUKS-1624-WW	\$3883.34	\$3900.21	\$4005.65	\$4022.52
		30"(762mm)	UUKS-1630-WW	3983.54	4002.50	4105.85	4124.81
		36"(914mm)	UUKS-1636-WW	4083.74	4104.79	4206.05	4227.10
		42"(1067mm)	UUKS-1642-WW	4183.94	4207.08	4306.25	4329.39
		48"(1219mm)	UUKS-1648-WW	4323.95	4349.18	4446.26	4471.49
		54"(1372mm)	UUKS-1654-WW	4671.15	4698.47	4793.46	4820.78
		60"(1524mm)	UUKS-1660-WW	5040.79	5070.20	5163.10	5192.51
		66"(1676mm)	UUKS-1666-WW	5885.91	5917.41	6008.22	6039.72
		72"(1829mm)	UUKS-1672-WW	6724.31	6757.90	6846.62	6880.21

Height	Depth	Width	Wood Single Slider Door Number ①	Wood A Trim		Wood B Trim	
				A	B	A	B
16"(406mm)	14"(356mm)	24"(610mm)	UUHS-1624-WW	\$2460.37	\$ 2477.24	\$2582.68	\$2599.55
		30"(762mm)	UUHS-1630-WW	2547.85	2566.81	2670.16	2689.12
		36"(914mm)	UUHS-1636-WW	2635.33	2656.38	2757.64	2778.69
		42"(1067mm)	UUHS-1642-WW	2722.81	2745.95	2845.12	2868.26
		48"(1219mm)	UUHS-1648-WW	2810.29	2835.52	2932.60	2957.83
		54"(1372mm)	UUHS-1654-WW	2897.77	2925.09	3020.08	3047.40
		60"(1524mm)	UUHS-1660-WW	3242.52	3271.93	3364.83	3394.24
		66"(1676mm)	UUHS-1666-WW	3764.44	3795.94	3886.75	3918.25
		72"(1829mm)	UUHS-1672-WW	4328.57	4362.16	4450.88	4484.47

Wall Mount Components

Wall Track

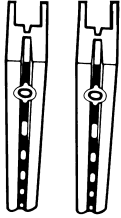

WT
Class AA

Features

- Includes two wall tracks and attachment screws (#10 2.5"(51mm) long).
- For attachment of components to structural walls.
- See installation instructions for proper mounting.

Specification Tip

- Not for use with up-mount overhead storage unit.

To Order, Specify:

- 1) Product number.
- 2) Trim color for track.

Height	Depth	Width	Number	Trim	
				A	B
60"(1524mm)	0.75"(19mm)	0.625"(16mm)	WT-60	\$268.80	\$282.19
72"(1829mm)			WT-72	315.58	328.97
84"(2134mm)			WT-84	362.36	375.75

Back for Wall Mounted Overhead Storage Unit

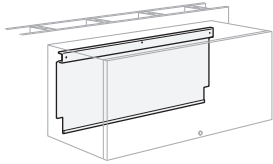

UUFB-P
Class CA

Features

- Includes one painted back and mounting hardware.
- Used to cover wall mount attachment brackets.

Specification Tips

- For use on Wall Mount Overhead Storage Units only.
- Back must match width of Wall Mounted Overhead Storage Units.

To Order, Specify:

- 1) Product number.
- 2) Trim color.

Outside Height	Width	Number	Trim	
			A	B
16"(406mm)	24"(610mm)	UUFB-0024-P	\$446.16	\$ 491.58
	30"(762mm)	UUFB-0030-P	456.57	501.99
	36"(914mm)	UUFB-0036-P	466.98	512.40
	42"(1067mm)	UUFB-0042-P	477.39	522.81
	48"(1219mm)	UUFB-0048-P	487.80	533.22
	54"(1372mm)	UUFB-0054-P	498.21	543.63
	60"(1524mm)	UUFB-0060-P	508.62	554.04
	66"(1676mm)	UUFB-0066-P	519.03	564.45
	72"(1829mm)	UUFB-0072-P	529.44	574.86

Worksurface and Gallery Panel Wall Mount Bracket

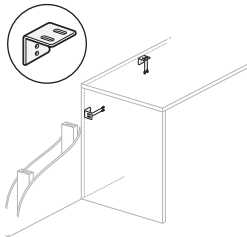

ZUBW
Class CA

Feature

- Includes one steel non-handed bracket and hardware.

Specification Tips

- **Screws/anchors for attachment to wall are field supplied.**
- **Must be properly anchored to a structural wall.**

- May be used to mount:
 - Gallery Panel to wall
 - Two brackets required
 - Worksurface to wall
 - 24"(610mm)-42"(1067mm)W requires two brackets
 - 48"(1219mm)-78"(1981mm)W requires three brackets
 - 84"(2134mm)-120"(3048mm)W requires four brackets
 - Worksurface Support Panel to wall
 - One bracket required
- Worksurface front corner support requirements:
 - One corner must be floor supported.
 - Second corner must be floor supported or attached to an adjacent worksurface with flush mount kit.
 - Distance between floor supports may not exceed 10 feet.

To Order, Specify:

- 1) Product number.
- 2) Trim color (if applicable).

Description	Depth	Width	Number	Price	Trim	
					A	B
Attachment Bracket (Black)	2"(51mm)	2"(51mm)	ZUBW-0000-PN	\$ 43.91	N/A	N/A
Attachment Bracket (trim color required)	2"(51mm)	2"(51mm)	ZUBW-0000-CN	N/A	\$ 50.91	\$ 59.80

Wall Mount Components

Tackboard, Wall Mount

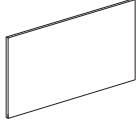

KUAF
Class CA

Feature

- Includes one tackboard and attachment hardware for structural wall.

Specification Tips

- Designed to be used under wall mounted overhead storage units.
- **Not for use with wall track.**

To Order, Specify:

- 1) Product number.
- 2) Fabric surface and color.

Nominal Height	Width	Number	Fabric					
			A	B	C	E	F	G
16"(406mm)	24"(610mm)	KUAF-1624	\$ 313.34	\$323.66	\$333.98	\$385.63	\$ 413.95	\$ 431.63
	30"(762mm)	KUAF-1630	370.55	383.45	396.35	460.92	496.32	518.42
	36"(914mm)	KUAF-1636	436.12	451.64	467.12	544.60	587.08	613.64
	42"(1067mm)	KUAF-1642	494.72	512.83	530.89	621.28	670.84	701.83
	48"(1219mm)	KUAF-1648	553.33	574.02	594.66	697.97	754.61	790.02
	54"(1372mm)	KUAF-1654	611.93	635.21	658.43	774.65	838.37	878.21
	60"(1524mm)	KUAF-1660	670.53	696.40	722.20	851.33	922.13	966.40

Markerboard, Wall Mount

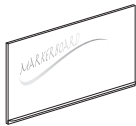

KUAM
Class CA

Features

- Includes non-magnetic white laminate erasable writing surface with tray and attachment hardware for structural wall.
- Tray available in charcoal only.
- Markers and erasers not included.

Specification Tips

- Designed to be used under wall mounted overhead storage units.
- Does not allow task light cord to pass behind.

- **Not for use with wall track.**

- **The following products are recommended to maintain the markerboard appearance:**

- Dry erase marker kit (includes holder, six markers and eraser), order part# 7062-8001.
- Markerboard cleaner and conditioner, order part# 7031-7001.
- Markerboard spray cleaner, order part# 7031-7002.

To Order, Specify:

- 1) Product number.
(No finish specification required.)

Nominal Height	Width	Number	Price
16"(406mm)	24"(610mm)	KUAM-1624	\$ 517.40
	30"(762mm)	KUAM-1630	546.65
	36"(914mm)	KUAM-1636	575.90
	42"(1067mm)	KUAM-1642	605.15
	48"(1219mm)	KUAM-1648	634.40
	54"(1372mm)	KUAM-1654	663.65
	60"(1524mm)	KUAM-1660	692.90
24"(610mm)	24"(610mm)	KUAM-2424	\$ 681.31
	30"(762mm)	KUAM-2430	710.56
	36"(914mm)	KUAM-2436	739.81
	42"(1067mm)	KUAM-2442	769.06
	48"(1219mm)	KUAM-2448	798.31
	54"(1372mm)	KUAM-2454	827.56
	60"(1524mm)	KUAM-2460	856.81
32"(813mm)	24"(610mm)	KUAM-3224	\$ 921.58
	30"(762mm)	KUAM-3230	950.83
	36"(914mm)	KUAM-3236	980.08
	42"(1067mm)	KUAM-3242	1009.33
	48"(1219mm)	KUAM-3248	1038.58
	54"(1372mm)	KUAM-3254	1067.83
	60"(1524mm)	KUAM-3260	1097.08

Wall Mount Components

Adaptable Shelf Divider

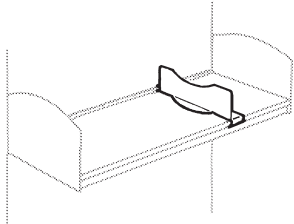

NADR-8
Class CA

Features

- Includes box of eight shelf dividers.
- To be used to divide space laterally on panel mounted shelves or up mount shelves, standard or up mount overhead storage units, or vertical storage units, Adaptable open shelf and Adaptable overhead storage unit.

To Order, Specify:

- 1) Product number.
- 2) Trim color.

Height	Depth	Width	Number	Trim	
				A	B
4"(102mm)	13.25"(337mm)	1.75"(44mm)	NADR-8	\$477.08	\$502.89

Wall Mount Components

Slat, Wall Mount

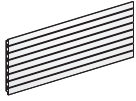

KUPY
Class CA

Features

- Includes slat tile & attachment brackets.
- Belong work tools and Jump Stuff slat tile tools may be used.

Specification Tips

- Designed to be used under wall mounted overhead storage units.
- Allows space for task light cord routing.

To Order, Specify:

- 1) Product number.
- 2) Trim color.

Nominal Height	Width	Number	Trim	
			A	B
16"(406mm)	18"(457mm)	KUPY-1618	\$452.36	\$460.75
	24"(610mm)	KUPY-1624	489.71	500.18
	30"(762mm)	KUPY-1630	527.06	539.61
	36"(914mm)	KUPY-1636	564.41	579.04
	42"(1067mm)	KUPY-1642	601.76	618.47
	48"(1219mm)	KUPY-1648	639.11	657.90
	54"(1372mm)	KUPY-1654	676.46	697.33
	60"(1524mm)	KUPY-1660	713.81	736.76

Tack Strips/Tackboards

Tack Strip



HTB
Class AC

Features

- Includes tack strip and attachment hardware.
- HTB tack strips can be applied to all panel surface types.
- Tack strip to be installed on one or more panels of equivalent widths when designated tack area is required or can be mounted to wall track.

To Order, Specify:

- 1) Product number.
- 2) Fabric surface and color.

Height	Thickness	Width	Number	Fabric					
				A	B	C	E	F	G
5"(127mm)	1"(25mm)	24"(610mm)	HTB-2405	\$362.75	\$ 417.02	\$478.54	\$608.83	\$699.30	\$753.56
		30"(762mm)	HTB-3005	378.30	434.89	499.06	634.95	729.29	785.87
		36"(914mm)	HTB-3605	393.85	452.76	519.58	661.07	759.28	818.18
		42"(1067mm)	HTB-4205	409.40	470.63	540.10	687.19	789.27	850.49
		48"(1219mm)	HTB-4805	424.95	488.50	560.62	713.31	819.26	882.80
		54"(1372mm)	HTB-5405	440.50	506.37	581.14	739.43	849.25	915.11
		60"(1524mm)	HTB-6005	456.05	524.24	601.66	765.55	879.24	947.42

Tackboard

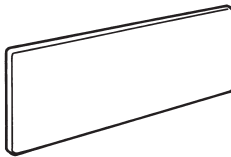

HTB
Class AC

Features

- Includes tackboard and attachment hardware.
- HTB tackboards can be applied to all panel surface types.
- Tackboard to be installed on one or more panels of equivalent widths when designated tack area required or can be mounted to wall track.

To Order, Specify:

- 1) Product number.
- 2) Fabric surface and color.

Height	Thickness	Width	Number	Fabric					
				A	B	C	E	F	G
11"(279mm)	1"(25mm)	24"(610mm)	HTB-2411	\$424.85	\$488.60	\$560.80	\$ 713.23	\$ 819.30	\$ 882.74
16"(406mm)			HTB-2416	476.60	548.25	629.35	800.23	919.30	990.39
33"(838mm)			HTB-2433	652.55	751.06	862.42	1096.03	1259.30	1356.40
11"(279mm)	1"(25mm)	30"(762mm)	HTB-3011	\$440.40	\$506.47	\$ 581.32	\$ 739.35	\$ 849.29	\$ 915.05
16"(406mm)			HTB-3016	492.15	566.12	649.87	826.35	949.29	1022.70
33"(838mm)			HTB-3033	668.10	768.93	882.94	1122.15	1289.29	1388.71
11"(279mm)	1"(25mm)	36"(914mm)	HTB-3611	\$455.95	\$524.34	\$ 601.84	\$ 765.47	\$ 879.28	\$ 947.36
16"(406mm)			HTB-3616	507.70	583.99	670.39	852.47	979.28	1055.01
33"(838mm)			HTB-3633	683.65	786.80	903.46	1148.27	1319.28	1421.02
11"(279mm)	1"(25mm)	42"(1067mm)	HTB-4211	\$ 471.50	\$542.21	\$622.36	\$ 791.59	\$ 909.27	\$ 979.67
16"(406mm)			HTB-4216	523.25	601.86	690.91	878.59	1009.27	1087.32
33"(838mm)			HTB-4233	699.20	804.67	923.98	1174.39	1349.27	1453.33
11"(279mm)	1"(25mm)	48"(1219mm)	HTB-4811	\$ 487.05	\$560.08	\$642.88	\$ 817.71	\$ 939.26	\$ 1011.98
16"(406mm)			HTB-4816	538.80	619.73	711.43	904.71	1039.26	1119.63
33"(838mm)			HTB-4833	714.75	822.54	944.50	1200.51	1379.26	1485.64
11"(279mm)	1"(25mm)	54"(1372mm)	HTB-5411	\$502.60	\$ 577.95	\$663.40	\$ 843.83	\$ 969.25	\$1044.29
16"(406mm)			HTB-5416	554.35	637.60	731.95	930.83	1069.25	1151.94
33"(838mm)			HTB-5433	730.30	840.41	965.02	1226.63	1409.25	1517.95
11"(279mm)	1"(25mm)	60"(1524mm)	HTB-6011	\$ 518.15	\$595.82	\$683.92	\$ 869.95	\$ 999.24	\$1076.60
16"(406mm)			HTB-6016	569.90	655.47	752.47	956.95	1099.24	1184.25
33"(838mm)			HTB-6033	745.85	858.28	985.54	1252.75	1439.24	1550.26

Markerboards/Wall Accessory Slat Pad

Markerboard — Non-Magnetic Surface

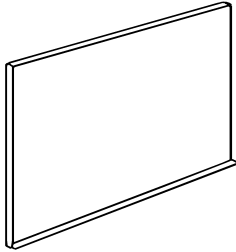

MEAM
Class CA

HNAM
Class BA

Features

- Includes markerboard and tray.
- White erasable writing surface with tray for storage of dry erase markers and eraser.
- Markers and erasers not included.
- Non-magnetic.
- Tray is standard in charcoal and edge is standard in white finish colors.
- May be used on wall track.

Specification Tips

- **The following products are recommended to maintain the markerboard appearance:**
 - Dry erase marker kit (includes holder, six markers and eraser), order part# 7062-8001.
 - Markerboard cleaner and conditioner, order part# 7031-7001.
 - Markerboard spray cleaner, order part# 7031-7002.

To Order, Specify:

- 1) Product number.
(No finish specification required.)

Height	Depth	Width	Number	Price
16"(406mm)	3.25"(83mm)	30"(762mm)	MEAM-3016	\$ 571.08
		36"(914mm)	MEAM-3616	600.00
		42"(1067mm)	MEAM-4216	628.92
		48"(1219mm)	MEAM-4816	657.84
23.125"(587mm)	3.25"(83mm)	60"(1524mm)	MEAM-6016	715.68
		30"(762mm)	HNAM-3023	\$ 747.77
		36"(914mm)	HNAM-3623	796.79
		42"(1067mm)	HNAM-4223	845.81
48.125"(1222mm)	3.25"(83mm)	48"(1219mm)	HNAM-4823	894.83
		60"(1524mm)	HNAM-6023	992.87
		60"(1524mm)	HNAM-6048	\$1306.62

Wall Accessory Slat Pad

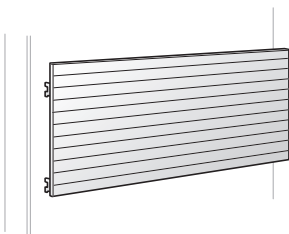

HGRY
Class BA

Features

- Includes one pad, end caps and attachment brackets.
- Assembled slat pad thickness is 0.375"(10mm).

Specification Tips

- Attaches to a UniGroup Too, UniGroup or panel or a combination of panels that equal the pad width.
- Designed to work with Belong work tools and Jump Stuff slat pad tools.
- Can be mounted under a shelf or overhead storage unit.
- Intended to provide paper management capabilities.
- May be used on wall track.

To Order, Specify:

- 1) Product number.
- 2) Trim color.

Height	Width	Number	Trim	
			A	B
16"(406mm)	24"(610mm)	HGRY-2416	\$ 437.75	\$492.45
	30"(762mm)	HGRY-3016	484.20	538.90
	36"(914mm)	HGRY-3616	530.35	585.05
	42"(1067mm)	HGRY-4216	576.80	631.50
	48"(1219mm)	HGRY-4816	622.95	677.65
	54"(1372mm)	HGRY-5416	669.40	724.10
	60"(1524mm)	HGRY-6016	715.55	770.25

Markerboard Accessories

Markerboard Accessories

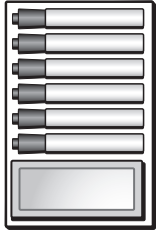

7062-8001

Feature

- Recommended dry erase marker products to maintain, clean & condition markerboards.

To Order, Specify:

- 1) Product number
(No finish specification required.)

Description	Number	Price
Dry Erase Marker Kit (holder, six markers and eraser)	7062-8001	\$220.31
Cleaner and Conditioner	7031-7001	263.03
Spray Cleaner	7031-7002	80.29



7031-7002



7031-7001
Class YA

Belong Work Tools Mounting Rails

For use with Adaptable Worksurfaces

Tool Rail — Worksurface Mount C-Clamp or Thru-Mount

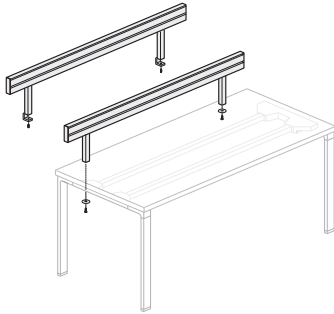

KURI-1224-CSN
Class YA

Features

- Includes one double sided rail with two posts, two rail end caps and attachment hardware.
- Mounts to worksurface to support rail tools.
- 1.19”(30mm) C-clamp Rail mounts on worksurfaces from 0.75”(19mm) to 1.75”(44mm) thick.
- Thru-mount Rail mounts on 1.19”(30mm) thick worksurfaces.
- Posts are 1.25”(32mm) thick.
- Belong Rail tools separately specified.
- Belong Work Tools or JumpStuff Slat Pad Tools may be used; separately specified.
- Rail overall height above worksurface: 11.81”(300mm).
- Distance between rail bottom and top of worksurface: 7.44”(189mm).
- Ships unassembled.

Specification Tips

- Designed for single sided Reside desking and single sided benching applications.
- **Not designed to be used in front of panel mounted accessories (tackboard, markerboard).**
- Rail holds up to a maximum of 40 pounds(18.14kg) evenly distributed on one side.
- Rail may be installed off modular.
- Heavy load application; additional posts can be ordered.
- Monitor arm cannot be mounted in post positions.
- Thru-mount post can be attached flush to back edge of worksurface.
- C-clamp rail can be attached to panel mounted worksurface with notch or radius wireways without removing the worksurface.
- Under worksurface: 4”(102mm) of clearance is necessary between back of worksurface and adjacent component for clamp attachment.
- Gap between screen and horizontal surface allows installation of Belong Tool Rail.
- Utility tray provides clearance for installation of Belong Tool Rail.
- Refer to Specification Guide for planning rules.

Note: No more than 6”(152mm) of rail can be extended beyond outside of support.

To Order, Specify:

- 1) Product number.
- 2) Trim color for rail/post.
- 3) Trim color for rail end caps:
 - TR-K Charcoal
 - TR-J Graphite
 - TR-FM Snow

Rail Height	Width	Description	Number	Price	
				A	B
1.19”(30mm) Thick Top					
4”(102mm)	24”(610mm)	C-Clamp	KURI-1224-CSN	\$490.46	\$ 512.47
	30”(762mm)		KURI-1230-CSN	516.50	540.51
	36”(914mm)		KURI-1236-CSN	542.54	568.55
	42”(1067mm)		KURI-1242-CSN	568.58	596.59
	48”(1219mm)		KURI-1248-CSN	594.62	624.63
	54”(1372mm)		KURI-1254-CSN	620.66	652.67
	60”(1524mm)		KURI-1260-CSN	780.83	814.84
2”(51mm) thick Top					
4”(102mm)	24”(610mm)	C-Clamp	KURI-1224-CMN	\$490.46	\$ 512.47
	30”(762mm)		KURI-1230-CMN	516.50	540.51
	36”(914mm)		KURI-1236-CMN	542.54	568.55
	42”(1067mm)		KURI-1242-CMN	568.58	596.59
	48”(1219mm)		KURI-1248-CMN	594.62	624.63
	54”(1372mm)		KURI-1254-CMN	620.66	652.67
	60”(1524mm)		KURI-1260-CMN	780.83	814.84
1.19”(30mm) Thick Top					
4”(102mm)	24”(610mm)	Thru-mount	KURI-1224-TSN	\$490.46	\$ 512.47
	30”(762mm)		KURI-1230-TSN	516.50	540.51
	36”(914mm)		KURI-1236-TSN	542.54	568.55
	42”(1067mm)		KURI-1242-TSN	568.58	596.59
	48”(1219mm)		KURI-1248-TSN	594.62	624.63
	54”(1372mm)		KURI-1254-TSN	620.66	652.67
	60”(1524mm)		KURI-1260-TSN	780.83	814.84
2”(51mm) thick Top					
4”(102mm)	24”(610mm)	Thru-mount	KURI-1224-TMN	\$490.46	\$ 512.47
	30”(762mm)		KURI-1230-TMN	516.50	540.51
	36”(914mm)		KURI-1236-TMN	542.54	568.55
	42”(1067mm)		KURI-1242-TMN	568.58	596.59
	48”(1219mm)		KURI-1248-TMN	594.62	624.63
	54”(1372mm)		KURI-1254-TMN	620.66	652.67
	60”(1524mm)		KURI-1260-TMN	780.83	814.84

Belong Work Tools Mounting Rails

For use with Adaptable Worksurfaces

Tool Rail — Single Post — C-Clamp or Thru-mount

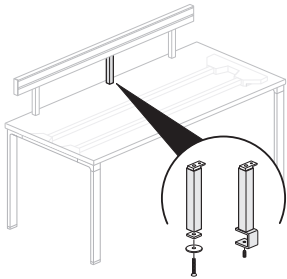

KUPI-0000-CSN
Class YA

Features

- Includes one C-clamp or one Thru-mount Post and attachment hardware.
- Posts mount on worksurfaces 1.81"(46mm)-2"(51mm) thick.
- Posts are 1.25"(32mm) thick.

Specification Tips

- Posts supports slide along rail bottom groove.
- For use with C-clamp or Thru-mount tool rail only.
- Monitor arm cannot be mounted in post position.
- Extra single posts can be ordered when additional support for monitor arms and paper management are attached to Tool Rail.
- Refer to Specification Guide for planning rules.

To Order, Specify:

- 1) Product number.
- 2) Trim color.

Post Height	Description	Number	Price	
			A	B
1.19"(30mm) Thick Top				
7.5"(191mm)	C-Clamp	KUPI-0000-CSN	\$152.12	\$164.13
2"(51mm) Thick Top				
7.5"(191mm)	C-Clamp	KUPI-0000-CMN	\$152.12	\$164.13
1.19"(30mm) Thick Top				
7.5"(191mm)	Thru-mount	KUPI-0000-TSN	\$152.12	\$164.13
2"(51mm) Thick Top				
7.5"(191mm)	Thru-mount	KUPI-0000-TMN	\$152.12	\$164.13

Lighting

Task

Reed Premiere™ Stand-Alone LED Task Light

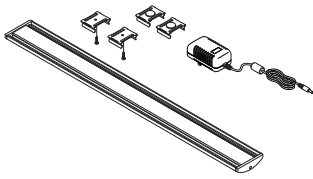

LUTS-0017-19ULD5
Class YA

Features

- Includes 17"(432mm) LED fixture, 15 watt power supply with nine foot removable power cord.
- Standard in anodized (silver) color with white end caps.
- Height: 0.5"(13mm); Width: 2.0"(51mm); Length: 16.4"(417mm).

Specification Tips

- For use with 120 volt, 60 hertz electrical system.
- Color Temp: 3500K.
- Color Rendition Index: 84 CRI.
- Rated Lifespan: 50,000 hour.
- Not intended for daisy chaining.
- Single touch on/off with continuous dimming from 15-100%.
- Automatic shutoff after 10 hours.
- Includes screw and magnetic attachment hardware for steel, laminate and wood.
- Intended for use in horizontal applications.

To Order, Specify:

- 1) Product number.
(No finish specification required.)

Fixture Length	Watts	Number	Price
16.4"(417mm)	7.8	LUTS-0017-19ULD5	\$ 403.51

Reed Premier™ Starter LED Task Light

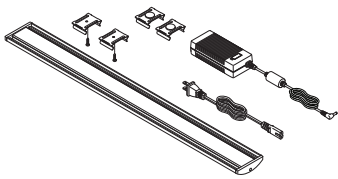

LUTS-0017-12ULD6
Class YA

Features

- Includes LED fixture, 60 watt power supply with twelve foot removable power cord.
- Standard in anodized (silver) color with white end caps.
- Height: 0.5"(13mm); Width: 2.0"(51mm); Lengths: 16.4"(417mm), 30.1"(765mm), 43.7"(1110mm) or 57.4"(1458mm).

Specification Tips

- For use with 120 volt, 60 hertz electrical system.
- Color Temp: 3500K.
- Color Rendition Index: 84 CRI.
- Rated Lifespan: 50,000 hour.
- Refer to the Specification Guide for a chart showing the total number of light fixtures that can be daisy chained together.
- Single touch on/off with continuous dimming from 15-100%.
- Automatic shutoff after 10 hours.
- Includes screw and magnetic attachment hardware for steel, laminate and wood.
- Intended for use in horizontal applications.

To Order, Specify:

- 1) Product number.
(No finish specification required.)

Fixture Length	Watts	Number	Price
16.4"(417mm)	7.8	LUTS-0017-12ULD6	\$ 554.84
30.1"(765mm)	17.6	LUTS-0031-12ULD6	807.40
43.7"(1110mm)	25.9	LUTS-0044-12ULD6	1041.92
57.4"(1458mm)	33.6	LUTS-0058-12ULD6	1294.48

Lighting

Task

Reed Premiere™ Add-On LED Task Light — For Use with Reed Premier Starter LED Task Lights

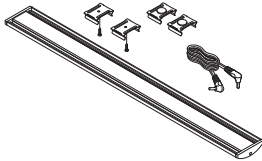

LUTD-0017-1NULDN
Class YA



Features

- Includes LED fixture, 8”(203mm) and 30”(762mm) daisy chain cord.
- Standard in anodized (silver) color with white end caps.
- Height: 0.5”(13mm); Width: 2.0”(51mm); Lengths: 16.4”(417mm), 30.1”(765mm), 43.7”(1110mm) or 57.4”(1458mm).

Specification Tips

- For use with 120 volt, 60 hertz electrical system.
- Color Temp: 3500K.
- Color Rendition Index: 84 CRI.
- Rated Lifespan: 50,000 hour.
- Refer to the Specification Guide for a chart showing the total number of light fixtures that can be daisy chained together.
- Single touch on/off with continuous dimming from 15-100%.
- Automatic shutoff after 10 hours.
- Includes screw and magnetic attachment hardware for steel, laminate and wood.
- Intended for use in horizontal applications.

To Order, Specify:

- 1) Product number.
(No finish specification required.)

Fixture Length	Watts	Number	Price
16.4”(417mm)	7.8	LUTD-0017-1NULDN	\$ 403.51
30.1”(765mm)	17.6	LUTD-0031-1NULDN	656.07
43.7”(1110mm)	25.9	LUTD-0044-1NULDN	890.59
57.4”(1458mm)	33.6	LUTD-0058-1NULDN	1143.15

Reed Premier™ Add-On Occupancy Sensor

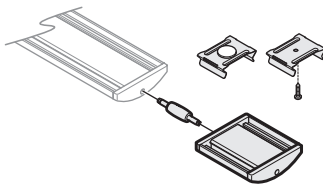

LUTS-0000
Class YA



Features

- Includes occupancy sensor and attachment connector.
- Standard in anodized (silver) color with white end caps.
- Height: 0.7”(18mm); Width: 2.0”(51mm); Length: 2.3”(58mm).

Specification Tips

- For use with 120 volt, 60 hertz electrical system.
- Includes screw and magnetic attachment hardware for steel, laminate and wood.
- Intended for use in horizontal applications.

To Order, Specify:

- 1) Product number.
(No finish specification required.)

Number	Price
LUTS-0000	\$ 454.00

Lighting

Task

Adaptable LED Task Light – Stand Alone

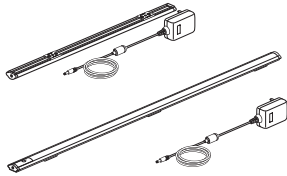

LUTN
Class YA – GSA Open Market



Features

- Includes 17"(432mm), 31"(787mm) or 44"(1118mm) LED fixture, one on/off/dimmer pack, 18 watt power supply with black nine foot power cord, two adhesive cord managers and screw/magnetic attachment hardware.
- Standard in anodized (silver) color with black caps.
- Height: 0.5"(13mm); Width: 1.18"(30mm).
- Automatic turn off after 12 hours (+/- 15 mins).

Specification Tips

- For use with 120 volt, 60 hertz electrical system.
- Color Temp: 3500K.
- Color Rendition Index: 85 CRI.
- Rated Lifespan: 52,000 hour.
- **Not intended for daisy chaining.**
- Single touch on/off with continuous dimming from 15-100% with last state memory.
- Intended for use under shelf or cabinet.

To Order, Specify:

- 1) Product number.
(No finish specification required.)

Fixture Length	Total Length with Switch	Watts	Number	Price
17"(432mm)	18.6"(472mm)	5.6	LUTN-0017-19ULDN	\$ 268.98
31"(787mm)	32.6"(828mm)	10.3	LUTN-0031-19ULDN	305.38
44"(1118mm)	45.6"(1158mm)	14.3	LUTN-0044-19ULDN	339.18

Adaptable LED Task Light – Starter Kit

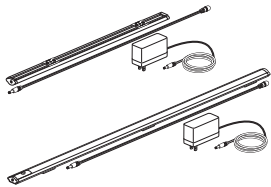

LUTT
Class YA – GSA Open Market



Features

- Includes LED fixture, one on/off/dimmer pack, 65 watt power supply with eleven foot power cord, two adhesive cord managers, and screw/magnetic attachment hardware.
- Standard in anodized (silver) color with black caps.
- Height: 0.5"(13mm); Width: 1.18"(30mm).
- Automatic turn off after 12 hours (+/- 15 mins).

Specification Tips

- For use with 120 volt, 60 hertz electrical system.
- Color Temp: 3500K.
- Color Rendition Index: 85 CRI.
- Rated Lifespan: 52,000 hour.
- Refer to the Specification Guide or under the Adaptable LED Task Light - Add-On Kit for a chart showing the total number of light fixtures that can be daisy chained together.
- Single touch on/off with continuous dimming from 15-100% with last state memory.
- The on/off dimmer switch on the Starter Kit fixture will control all connected Add-On lights.
- Intended for use under shelf or cabinet.

To Order, Specify:

- 1) Product number.
(No finish specification required.)

Fixture Length	Total Length with Switch	Watts	Number	Price
17"(432mm)	18.6"(472mm)	5.6	LUTT-0017-11ULDN	\$ 305.15
31"(787mm)	32.6"(828mm)	10.3	LUTT-0031-11ULDN	341.55
44"(1118mm)	45.6"(1158mm)	14.3	LUTT-0044-11ULDN	375.35

Lighting

Task

Adaptable LED Task Light – Add-On Kit

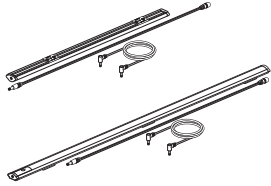

LUTA
Class YA – GSA Open Market



Features

- Includes LED fixture, 18”(457mm) daisy chain cord, two adhesive cord managers, and screw/magnetic attachment hardware.
- Standard in anodized (silver) color with black caps.
- Height: 0.5”(13mm); Width: 1.18”(30mm).

Specification Tips

- For use with 120 volt, 60 hertz electrical system.
- Color Temp: 3500K.
- Color Rendition Index: 85 CRI.
- Rated Lifespan: 52,000 hour.
- Refer to the chart at right for the total number of light fixtures that can be daisy chained together.
- The on/off dimmer switch on the Starter Kit fixture will control all connected Add-On lights.
- Intended for use under shelf or cabinet.

To Order, Specify:

- 1) Product number.
(No finish specification required.)

Acceptable Daisy Chain Light Combinations

Daisy Chain Combinations	# of 17” Lights	# of 31” Lights	# of 44” Lights
Combination 1	1	1	1
Combination 2	1	1	0
Combination 3	1	2	0
Combination 4	1	0	1
Combination 5	1	0	0
Combination 6	2	1	0
Combination 7	2	0	1
Combination 8	2	0	0
Combination 9	3	1	0
Combination 10	3	0	0
Combination 11	4	0	0
Combination 12	0	1	1
Combination 14	0	2	0
Combination 15	0	3	0
Combination 17	0	0	2

Fixture Length	Watts	Number	Price
17”(432mm)	5.6	LUTA-0017-1NULDN	\$ 226.51
31”(787mm)	10.3	LUTA-0031-1NULDN	262.91
44”(1118mm)	14.3	LUTA-0044-1NULDN	296.71

UniGroup Too Resources

Surfaces Materials

COM Yardage Requirements

Index

Warranty/Terms of Sale

Surface Materials

Finish Color Legend

Wood

Grade A

Double Cut

2P-RL	Applegate
CQ-HKL	Auburn
CQ-HBF	Clove
WE-RD	Dune
WJ-RE	Ebony ⁽¹⁾
2N-RL	Echo
WE-RT	Melba ⁽¹⁾
W4-PB	Pebble
CQ-WG	Walnut Grove

Grade B

Cherry

VC-CA1	Amber
VC-W23	American
VC-HKF	Burgundy
VC-W33	Caramel
VC-W30	Heritage
VC-W32	Pacific
VC-HKA	Toffee

Maple

VP-LM	Light
VP-N	Natural ⁽²⁾

Maple Quarter Cut

NM-N	Natural
------	---------

Oak

VJ-HKC	Urban
--------	-------

Rift Cut White Oak

NR-W15	Espresso
NR-W40	Mocha

Walnut

VR-CPK	Bourbon
VR-HKG	Colombian
VR-W15	Espresso
VR-W31	Retro

Walnut Quarter Cut

NW-W35	Clear
NW-W31	Retro

HPL

Grade A

Solid Color

H-34	Beige
H-AK	Chalk
H-8J	Charcoal
H-3J	Graphite
H-62	Gray Tone
H-WL	Linen
H-3P	Platinum
H-AA	Putty
H-3E	Smoke

Patterned

H-P1	Linen Casual
H-P2	Linen Classic
H-P3	Linen Crisp
H-P4	Linen Flax

Wood

H-B06	Brazilwood
H-E79	Colombian Walnut
H-AE	Maple
H-DYP	New Age Oak
H-E15	River Cherry
H-C09	Williamsburg Cherry

Grade B

Premium Wood Grain

H-C8	Blonde Modern Cherry
H-D1	Daintree
H-KP	Field Elm
H-KN	Grey Elm
H-KM	Landmark Wood
H-D2	Mocha Modern Cherry
H-KL	Neo Walnut
H-KR	Phantom Ecru
H-KS	Phantom Pearl
H-C9	Spiced Modern Cherry

Grade E

Premium

H-C2	Drift
H-C6	Hatch
H-C1	Hay
H-C5	Mineral
H-C4	Molasses
H-C3	Pecan
H-C7	Tanned

Edgeband

Solid Color

HP-34	Beige
HP-AK	Chalk
HP-8J	Charcoal
HP-3J	Graphite
HP-62	Gray Tone
HP-WL	Linen
HP-3P	Platinum
HP-AA	Putty
HP-3E	Smoke

Patterned Edgeband

HP-P1	Linen Casual
HP-P2	Linen Classic
HP-P3	Linen Crisp
HP-P4	Linen Flax

Wood Grain

HP-C8	Blonde Modern Cherry
HP-B06	Brazilwood
HP-E79	Colombian Walnut
HP-D1	Daintree
HP-KP	Field Elm
HP-KN	Grey Elm
HP-KM	Landmark Wood
HP-AE	Maple
HP-D2	Mocha Modern Cherry
HP-KL	Neo Walnut
HP-DYP	New Age Oak
HP-KR	Phantom Ecru
HP-KS	Phantom Pearl
HP-E15	River Cherry
HP-C9	Spiced Modern Cherry
HP-C09	Williamsburg Cherry

Ply-Edge

HP-PW	Ply-Edge
-------	----------

Premium

HP-C2	Drift
HP-C6	Hatch
HP-C1	Hay
HP-C5	Mineral
HP-C4	Molasses
HP-C3	Pecan
HP-C7	Tanned

Trim

Grade A

TR-R	Beige
TR-AK	Chalk
TR-K	Charcoal
TR-J	Graphite
TR-G	Gray Tone
TR-AA	Putty
TR-E	Smoke

Grade B

TR-MC	Metallic Champagne
TR-LE	Metallic Silver
TR-MG	Metallic Gunmetal

Tempered Glass

Grade A

SK-1C	Clear
-------	-------

Grade C

SQ-ER	English Reeded
-------	----------------

Grade D

SQ-CM	Checks Mix
SQ-VM	Vertical Moire

Acrylic

SK-1E	Frosted Acrylic
-------	-----------------

Lock Plugs

LR-BL	Black
LR-BP	Chrome

⁽¹⁾Available on Adaptable Components only.

⁽²⁾Not available on UniGroup Panels.

ALERT: These materials are current, however they are being considered for future obsolescence due to low volume.

Wood	
VJ-W42	Brindle
2R-RL	Butternut
NW-W15	Espresso
NP-W08	Golden
NP-W07	Light
NX-U	Medium
VR-W12	Naturally Walnut
WC-RW	Wenge

HPL	
H-AM	Amber Cherry
H-AD	Medium Cherry

Edgeband	
HP-AM	Cherry
HP-AD	Medium Cherry

Forestry Stewardship Council (FSC) Statement:

In our continuing support of sustainable forestry and responsible purchasing, Haworth North America is offering FSC certified wood products at no up-charge. By providing FSC certified material, Haworth is supporting our client's green building goals and demonstrating our collective commitment to source materials more sustainably. Haworth will provide to you the necessary FSC-certified paperwork with your shipment. For more information, FAQs, and a complete FSC product list (including product exceptions), go to the Library and search FSC

Surface Materials

Fabrics/Color Legend

Vertical Fabrics

Grade A

- (36) Aerial
- (6X) Chevron
- (35) Etch
- (L6) Highlands
- (C1) Striae
- (PY) Tailored
- (3A) Tellure

Grade B

- (4HV) Blanket
- (33) Camp
- (L5) Classic
- (34) Fields
- (3JV) Hobson
- (6) Hue
- (3LV) Novelty
- (32) Peca
- (PV) Ritz
- (WS) Shimmer

Grade C

- (SW) Sisal
- (4S) Thorman

* For most current finish and fabric availability please reference surfaces.haworth.com.

ALERT: These materials are current, however they are being considered for future obsolescence due to low volume.

Vertical Fabrics

(PH) Birds Nest

Haworth+

For information on the Haworth+ alliance program, including images and product availability, please refer to: Haworth.com > Surface Collection > Haworth+ Library

Customer's Own Material (COM)

For general Customer's Own Material (COM) information including processes and forms, please refer to:

Haworth.com > Surface Collection > Resources > COM

For information on approved COM's, please refer to:

Haworth.com > Surface Collection > COM Library

COM Yardage Requirements

UniGroup Too

Actual (Inches)		54"(1372mm) Roll (Linear Yards)			66"(1676mm) Roll (Linear Yards)		
Height	Width	Directional Rightway	Directional Railroad	Non-directional	Directional Rightway	Directional Railroad	Non-directional
Straight Panel (one side)							
32"(813mm)	24"(610mm)	0.42	0.78	0.42	0.42	0.39	0.39
	30"(762mm)	0.83	0.94	0.83	0.42	0.47	0.42
	36"(914mm)	0.83	1.11	0.83	0.83	0.56	0.56
	42"(1067mm)	0.83	1.28	0.83	0.83	0.64	0.64
	48"(1219mm)	0.83	1.44	0.83	0.83	0.72	0.72
	60"(1524mm)	N/A	1.78	1.78	0.83	0.89	0.83
40"(1016mm)	24"(610mm)	0.51	0.78	0.51	0.51	0.78	0.51
	30"(762mm)	1.03	0.94	0.94	0.51	0.94	0.51
	36"(914mm)	1.03	1.11	1.03	1.03	1.11	1.03
	42"(1067mm)	1.03	1.28	1.03	1.03	1.28	1.03
	48"(1219mm)	1.03	1.44	1.03	1.03	1.44	1.03
	60"(1524mm)	N/A	1.78	1.78	1.03	1.78	1.03
48"(1219mm)	24"(610mm)	0.61	0.78	0.61	0.61	0.78	0.61
	30"(762mm)	1.22	0.94	0.94	0.61	0.94	0.61
	36"(914mm)	1.22	1.11	1.11	1.22	1.11	1.11
	42"(1067mm)	1.22	1.28	1.22	1.22	1.28	1.22
	48"(1219mm)	1.22	1.44	1.22	1.22	1.44	1.22
	60"(1524mm)	N/A	1.78	1.78	1.22	1.78	1.22
56"(1422mm)	24"(610mm)	0.78	0.78	0.78	0.78	0.78	0.78
	30"(762mm)	1.56	0.94	0.94	0.78	0.94	0.78
	36"(914mm)	1.56	1.11	1.11	1.56	1.11	1.11
	42"(1067mm)	1.56	1.28	1.28	1.56	1.28	1.28
	48"(1219mm)	1.56	1.44	1.44	1.56	1.44	1.44
	60"(1524mm)	N/A	1.78	1.78	1.56	1.78	1.56
64"(1626mm)	24"(610mm)	0.89	N/A	0.89	0.89	0.78	0.78
	30"(762mm)	1.78	N/A	1.78	0.89	0.94	0.89
	36"(914mm)	1.78	N/A	1.78	1.78	1.11	1.11
	42"(1067mm)	1.78	N/A	1.78	1.78	1.28	1.28
	48"(1219mm)	1.78	N/A	1.78	1.78	1.44	1.44
	60"(1524mm)	N/A	N/A	N/A	1.78	1.78	1.78
72"(1829mm)	24"(610mm)	0.94	N/A	0.94	0.94	0.78	0.78
	30"(762mm)	1.89	N/A	1.89	0.94	0.94	0.94
	36"(914mm)	1.89	N/A	1.89	1.89	1.11	1.11
	42"(1067mm)	1.89	N/A	1.89	1.89	1.28	1.28
	48"(1219mm)	1.89	N/A	1.89	1.89	1.44	1.44
	60"(1524mm)	N/A	N/A	N/A	1.89	1.78	1.78
80"(2032mm)	24"(610mm)	1.14	N/A	1.14	1.14	N/A	1.14
	30"(762mm)	2.28	N/A	2.28	1.14	N/A	1.14
	36"(914mm)	2.28	N/A	2.28	2.28	N/A	2.28
	42"(1067mm)	2.28	N/A	2.28	2.28	N/A	2.28
	48"(1219mm)	2.28	N/A	2.28	2.28	N/A	2.28
	60"(1524mm)	N/A	N/A	N/A	2.28	N/A	2.28

COM Yardage Requirements

UniGroup Too

Actual (Inches)		54"(1372mm) Roll (Linear Yards)			66"(1676mm) Roll (Linear Yards)		
Height	Width	Directional Rightway	Directional Railroad	Non-directional	Directional Rightway	Directional Railroad	Non-directional
Finish Posts							
32"(813mm)		0.10	0.10	0.10	0.08	0.10	0.08
40"(1016mm)		0.13	0.19	0.13	0.10	0.10	0.10
48"(1219mm)		0.16	0.19	0.16	0.12	0.19	0.12
56"(1422mm)		0.21	0.19	0.19	0.16	0.19	0.15
64"(1626mm)		0.24	N/A	0.24	0.19	0.19	0.19
72"(1829mm)		0.25	N/A	0.25	0.20	0.19	0.19
80"(2032mm)		0.31	N/A	0.31	0.24	N/A	0.24

Actual (Inches)		54"(1372mm) Roll (Linear Yards)			66"(1676mm) Roll (Linear Yards)		
Height	Width	Directional Rightway	Directional Railroad	Non-directional	Directional Rightway	Directional Railroad	Non-directional
Tackboard and Tack Strip							
5"(127mm)	24"(610mm)	0.31	0.21	0.21	0.31	0.14	0.14
	30"(762mm)	0.31	0.25	0.25	0.31	0.17	0.17
	36"(914mm)	0.31	0.29	0.29	0.31	0.19	0.19
	42"(1067mm)	0.31	0.33	0.31	0.31	0.22	0.22
	48"(1219mm)	0.31	0.38	0.31	0.31	0.25	0.25
	60"(1524mm)	N/A	0.46	0.46	0.31	0.31	0.31
11"(279mm)	24"(610mm)	0.47	0.42	0.42	0.47	0.28	0.28
	30"(762mm)	0.47	0.50	0.47	0.47	0.33	0.33
	36"(914mm)	0.47	0.58	0.47	0.47	0.39	0.39
	42"(1067mm)	0.47	0.67	0.47	0.47	0.44	0.44
	48"(1219mm)	0.47	0.75	0.47	0.47	0.50	0.47
	54"(1372mm)	N/A	0.83	0.83	0.47	0.56	0.47
16"(406mm)	24"(610mm)	0.61	0.42	0.42	0.61	0.28	0.28
	30"(762mm)	0.61	0.50	0.50	0.61	0.33	0.33
	36"(914mm)	0.61	0.58	0.58	0.61	0.39	0.39
	42"(1067mm)	0.61	0.67	0.61	0.61	0.44	0.44
	48"(1219mm)	0.61	0.75	0.61	0.61	0.50	0.50
	54"(1372mm)	N/A	0.83	0.83	0.61	0.56	0.56
33"(838mm)	24"(610mm)	1.08	0.83	0.83	1.08	0.83	0.83
	30"(762mm)	1.08	1.00	1.00	1.08	1.00	1.00
	36"(914mm)	1.08	1.17	1.08	1.08	1.17	1.08
	42"(1067mm)	1.08	1.33	1.08	1.08	1.33	1.08
	48"(1219mm)	1.08	1.50	1.08	1.08	1.50	1.08
	54"(1372mm)	N/A	1.67	1.67	1.08	1.67	1.08
60"(1524mm)	N/A	1.83	1.83	1.08	1.83	1.08	

COM Yardage Requirements

UniGroup

Actual (Inches)		54"(1372mm) Roll (Linear Yards)			66"(1676mm) Roll (Linear Yards)		
Height	Width	Directional Rightway	Directional Railroad	Non-directional	Directional Rightway	Directional Railroad	Non-directional
Straight Panel (one side)							
30"(762mm)	12"(305mm)	0.28	0.44	0.28	0.21	0.22	0.21
	18"(457mm)	0.42	0.61	0.42	0.28	0.31	0.28
	24"(610mm)	0.42	0.78	0.42	0.42	0.39	0.39
	30"(762mm)	0.83	0.94	0.83	0.42	0.47	0.42
	36"(914mm)	0.83	1.11	0.83	0.83	0.56	0.56
	42"(1067mm)	0.83	1.28	0.83	0.83	0.64	0.64
	48"(1219mm)	0.83	1.44	0.83	0.83	0.72	0.72
	54"(1372mm)	N/A	1.61	1.61	0.83	0.81	0.81
	60"(1524mm)	N/A	1.78	1.78	0.83	0.89	0.83
	37"(940mm)	12"(305mm)	0.34	0.44	0.34	0.26	0.44
18"(457mm)		0.51	0.61	0.51	0.34	0.61	0.34
24"(610mm)		0.51	0.78	0.51	0.51	0.78	0.51
30"(762mm)		1.03	0.94	0.94	0.51	0.94	0.51
36"(914mm)		1.03	1.11	1.03	1.03	1.11	1.03
42"(1067mm)		1.03	1.28	1.03	1.03	1.28	1.03
48"(1219mm)		1.03	1.44	1.03	1.03	1.44	1.03
54"(1372mm)		N/A	1.61	1.61	1.03	1.61	1.03
60"(1524mm)		N/A	1.78	1.78	1.03	1.78	1.03
44"(1118mm)		12"(305mm)	0.41	0.44	0.41	0.31	0.44
	18"(457mm)	0.61	0.61	0.61	0.41	0.61	0.41
	24"(610mm)	0.61	0.78	0.61	0.61	0.78	0.61
	30"(762mm)	1.22	0.94	0.94	0.61	0.94	0.61
	36"(914mm)	1.22	1.11	1.11	1.22	1.11	1.11
	42"(1067mm)	1.22	1.28	1.22	1.22	1.28	1.22
	48"(1219mm)	1.22	1.44	1.22	1.22	1.44	1.22
	54"(1372mm)	N/A	1.61	1.61	1.22	1.61	1.22
	60"(1524mm)	N/A	1.78	1.78	1.22	1.78	1.22
	50"(1270mm)	12"(305mm)	0.46	0.44	0.44	0.35	0.44
18"(457mm)		0.69	0.61	0.61	0.46	0.61	0.46
24"(610mm)		0.69	0.78	0.69	0.69	0.78	0.69
30"(762mm)		1.39	0.94	0.94	0.69	0.94	0.69
36"(914mm)		1.39	1.11	1.11	1.39	1.11	1.11
42"(1067mm)		1.39	1.28	1.28	1.39	1.28	1.28
48"(1219mm)		1.39	1.44	1.39	1.39	1.44	1.39
54"(1372mm)		N/A	1.61	1.61	1.39	1.61	1.39
60"(1524mm)		N/A	1.78	1.78	1.39	1.78	1.39
64"(1626mm)		12"(305mm)	0.59	N/A	0.59	0.44	0.44
	18"(457mm)	0.89	N/A	0.89	0.59	0.61	0.59
	24"(610mm)	0.89	N/A	0.89	0.89	0.78	0.78
	30"(762mm)	1.78	N/A	1.78	0.89	0.94	0.89
	36"(914mm)	1.78	N/A	1.78	1.78	1.11	1.11
	42"(1067mm)	1.78	N/A	1.78	1.78	1.28	1.28
	48"(1219mm)	1.78	N/A	1.78	1.78	1.44	1.44
	54"(1372mm)	N/A	N/A	N/A	1.78	1.61	1.61
	60"(1524mm)	N/A	N/A	N/A	1.78	1.78	1.78
	68"(1727mm)	12"(305mm)	0.63	N/A	0.63	0.47	0.44
18"(457mm)		0.94	N/A	0.94	0.63	0.61	0.61
24"(610mm)		0.94	N/A	0.94	0.94	0.78	0.78
30"(762mm)		1.89	N/A	1.89	0.94	0.94	0.94
36"(914mm)		1.89	N/A	1.89	1.89	1.11	1.11
42"(1067mm)		1.89	N/A	1.89	1.89	1.28	1.28
48"(1219mm)		1.89	N/A	1.89	1.89	1.44	1.44
54"(1372mm)		N/A	N/A	N/A	1.89	1.61	1.61
60"(1524mm)		N/A	N/A	N/A	1.89	1.78	1.78

COM Yardage Requirements

UniGroup

Actual (Inches)		54"(1372mm) Roll (Linear Yards)			66"(1676mm) Roll (Linear Yards)		
Height	Width	Directional Rightway	Directional Railroad	Non-directional	Directional Rightway	Directional Railroad	Non-directional
Straight Panel							
82"(2083mm)	12"(305mm)	0.76	N/A	0.76	0.57	N/A	0.57
	18"(457mm)	1.14	N/A	1.14	0.76	N/A	0.76
	24"(610mm)	1.14	N/A	1.14	1.14	N/A	1.14
	30"(762mm)	2.28	N/A	2.28	1.14	N/A	1.14
	36"(914mm)	2.28	N/A	2.28	2.28	N/A	2.28
	42"(1067mm)	2.28	N/A	2.28	2.28	N/A	2.28
	48"(1219mm)	2.28	N/A	2.28	2.28	N/A	2.28
	54"(1372mm)	N/A	N/A	N/A	2.28	N/A	2.28
	60"(1524mm)	N/A	N/A	N/A	2.28	N/A	2.28

Actual (Inches)		54"(1372mm) Roll (Linear Yards)			66"(1676mm) Roll (Linear Yards)		
Height	Width	Directional Rightway	Directional Railroad	Non-directional	Directional Rightway	Directional Railroad	Non-directional
Add-On Panel (one side)							
12"(305mm)	12"(305mm)	0.15	0.15	0.15	0.11	0.11	0.11
	18"(459mm)	0.22	0.20	0.20	0.15	0.15	0.15
	24"(610mm)	0.25	0.26	0.25	0.25	0.26	0.25
	30"(762mm)	0.50	0.32	0.32	0.25	0.32	0.25
	36"(914mm)	0.50	0.37	0.37	0.50	0.37	0.37
	42"(1067mm)	0.50	0.43	0.43	0.45	0.40	0.40
	48"(1219mm)	0.50	0.48	0.48	0.50	0.48	0.48
	54"(1372mm)	N/A	0.54	0.54	0.45	0.40	0.40
	60"(1524mm)	N/A	0.59	0.59	0.50	0.59	0.50
14"(356mm)	12"(305mm)	0.17	0.15	0.15	0.13	0.15	0.13
	18"(457mm)	0.25	0.20	0.20	0.17	0.20	0.17
	24"(610mm)	0.25	0.26	0.25	0.25	0.26	0.25
	30"(762mm)	0.50	0.31	0.31	0.25	0.31	0.25
	36"(914mm)	0.50	0.37	0.37	0.50	0.37	0.37
	42"(1067mm)	0.50	0.43	0.43	0.50	0.43	0.43
	48"(1219mm)	0.50	0.48	0.48	0.50	0.48	0.49
	54"(1372mm)	N/A	0.54	0.54	0.50	0.54	0.50
	60"(1524mm)	N/A	0.59	0.59	0.50	0.59	0.50
18"(457mm)	12"(305mm)	0.20	0.22	0.20	0.15	0.15	0.15
	18"(457mm)	0.31	0.31	0.31	0.20	0.20	0.20
	24"(610mm)	0.31	0.39	0.31	0.31	0.26	0.26
	30"(762mm)	0.61	0.47	0.47	0.31	0.31	0.31
	36"(914mm)	0.61	0.56	0.56	0.61	0.37	0.37
	42"(1067mm)	0.61	0.64	0.61	0.61	0.43	0.43
	48"(1219mm)	0.61	0.72	0.61	0.61	0.48	0.48
	54"(1372mm)	N/A	0.81	0.81	0.61	0.54	0.54
	60"(1524mm)	N/A	0.89	0.89	0.61	0.59	0.59
20"(508mm)	12"(305mm)	0.22	0.22	0.22	0.17	0.22	0.17
	18"(457mm)	0.33	0.31	0.31	0.22	0.31	0.22
	24"(610mm)	0.33	0.39	0.33	0.33	0.39	0.33
	30"(762mm)	0.67	0.47	0.47	0.33	0.47	0.33
	36"(914mm)	0.67	0.56	0.56	0.67	0.56	0.56
	42"(1067mm)	0.67	0.64	0.64	0.67	0.64	0.64
	48"(1219mm)	0.67	0.72	0.67	0.67	0.72	0.67
	54"(1372mm)	N/A	0.81	0.81	0.67	0.81	0.67
	60"(1524mm)	N/A	0.89	0.89	0.67	0.89	0.67

COM Yardage Requirements

UniGroup

Actual (Inches)		54"(1372mm) Roll (Linear Yards)			66"(1676mm) Roll (Linear Yards)		
Height	Width	Directional Rightway	Directional Railroad	Non-directional	Directional Rightway	Directional Railroad	Non-directional
Add-On Panel (continued)							
24"(610mm)	12"(305mm)	0.26	0.22	0.22	0.19	0.22	0.19
	18"(457mm)	0.39	0.31	0.31	0.26	0.31	0.26
	24"(610mm)	0.39	0.39	0.39	0.39	0.39	0.39
	30"(762mm)	0.78	0.47	0.47	0.39	0.47	0.39
	36"(914mm)	0.78	0.56	0.56	0.78	0.56	0.56
	42"(1067mm)	0.78	0.64	0.64	0.78	0.64	0.64
	48"(1219mm)	0.78	0.72	0.72	0.78	0.72	0.72
	54"(1372mm)	N/A	0.81	0.81	0.78	0.81	0.78
	60"(1524mm)	N/A	0.89	0.89	0.78	0.89	0.78
Wainscot Panel							
*	12"(305mm)	0.20	0.36	0.20	0.16	0.18	0.16
	18"(457mm)	0.40	0.53	0.40	0.27	0.26	0.26
	24"(610mm)	0.40	0.69	0.40	0.40	0.35	0.35
	36"(914mm)	0.81	1.03	0.81	0.81	0.51	0.51
	48"(1219mm)	0.81	1.36	0.81	0.81	0.68	0.68
	60"(1524mm)	N/A	1.69	1.69	0.81	0.85	0.81

*Usage for 67"/68" and 81"/82" high panels

Actual (Inches)		54"(1372mm) Roll (Linear Yards)			66"(1676mm) Roll (Linear Yards)		
Height	Width	Directional Rightway	Directional Railroad	Non-directional	Directional Rightway	Directional Railroad	Non-directional
Finish Posts							
30"(762mm)		0.10	0.10	0.10	0.08	0.10	0.08
37"(940mm)		0.13	0.19	0.13	0.10	0.10	0.10
44"(1118mm)		0.16	0.19	0.16	0.12	0.19	0.12
50"(1270mm)		0.18	0.19	0.18	0.14	0.19	0.14
56"(1422mm)		0.21	0.19	0.19	0.16	0.19	0.15
64"(1626mm)		0.24	N/A	0.24	0.19	0.19	0.19
68"(1727mm)		0.25	N/A	0.25	0.20	0.19	0.19
82"(2083mm)		0.31	N/A	0.31	0.24	N/A	0.24

Actual (Inches)		54"(1372mm) Roll (Linear Yards)			66"(1676mm) Roll (Linear Yards)		
Height	Width	Directional Rightway	Directional Railroad	Non-directional	Directional Rightway	Directional Railroad	Non-directional
Flipper Doors							
16 3/4"(425mm)	24"(610mm)	0.61	0.42	0.42	0.31	0.28	0.28
	30"(762mm)	0.61	0.50	0.50	0.61	0.33	0.33
	36"(914mm)	0.61	0.58	0.58	0.61	0.39	0.39
	42"(1067mm)	0.61	0.67	0.61	0.61	0.44	0.44
	48"(1219mm)	0.61	0.75	0.61	0.61	0.50	0.50
	60"(1524mm)	N/A	0.92	0.92	0.61	0.61	0.61

COM Yardage Requirements

UniGroup

Actual (Inches)		54"(1372mm) Roll (Linear Yards)			66"(1676mm) Roll (Linear Yards)		
Height	Width	Directional Rightway	Directional Railroad	Non-directional	Directional Rightway	Directional Railroad	Non-directional
Tackboard and Tack Strip							
5"(127mm)	24"(610mm)	0.31	0.21	0.21	0.31	0.14	0.14
	30"(762mm)	0.31	0.25	0.25	0.31	0.17	0.17
	36"(914mm)	0.31	0.29	0.29	0.31	0.19	0.19
	42"(1067mm)	0.31	0.33	0.31	0.31	0.22	0.22
	48"(1219mm)	0.31	0.38	0.31	0.31	0.25	0.25
	60"(1524mm)	N/A	0.46	0.46	0.31	0.31	0.31
11"(279mm)	24"(610mm)	0.47	0.42	0.42	0.47	0.28	0.28
	30"(762mm)	0.47	0.50	0.47	0.47	0.33	0.33
	36"(914mm)	0.47	0.58	0.47	0.47	0.39	0.39
	42"(1067mm)	0.47	0.67	0.47	0.47	0.44	0.44
	48"(1219mm)	0.47	0.75	0.47	0.47	0.50	0.47
	54"(1372mm)	N/A	0.83	0.83	0.47	0.56	0.47
16"(406mm)	24"(610mm)	0.61	0.42	0.42	0.61	0.28	0.28
	30"(762mm)	0.61	0.50	0.50	0.61	0.33	0.33
	36"(914mm)	0.61	0.58	0.58	0.61	0.39	0.39
	42"(1067mm)	0.61	0.67	0.61	0.61	0.44	0.44
	48"(1219mm)	0.61	0.75	0.61	0.61	0.50	0.50
	54"(1372mm)	N/A	0.83	0.83	0.61	0.56	0.56
33"(838mm)	24"(610mm)	1.08	0.83	0.83	1.08	0.83	0.83
	30"(762mm)	1.08	1.00	1.00	1.08	1.00	1.00
	36"(914mm)	1.08	1.17	1.08	1.08	1.17	1.08
	42"(1067mm)	1.08	1.33	1.08	1.08	1.33	1.08
	48"(1219mm)	1.08	1.50	1.08	1.08	1.50	1.08
	54"(1372mm)	N/A	1.67	1.67	1.08	1.67	1.08
60"(1524mm)	N/A	1.83	1.83	1.08	1.83	1.08	

Index

Products are listed alphabetically in this index by alpha-numeric prefix/suffix codes.

Product Code	Product Description	Page
7031-0501	Panel Accessories – Friction Pad	.64
7031-0501	Panel Accessories – Friction Pad	.94
7031-7001	Markerboard Accessories	.184
7031-7002	Markerboard Accessories	.184
7062-8001	Markerboard Accessories	.184
BFM-1-B	Electrical Components – Base Feed Module – Hardwire Connection	.103
BFM-1-C	Electrical Components — Hardwire – Base Feed Kit	.118
BFM-2-A	Electrical Components – Single Circuit Base Feed Module – Receptacle Connection with Power Cord	.104
BFM-2-B	Electrical Components – Single Circuit Base Feed Module – Receptacle Connection with Power Cord	.103
BFM-6-B	Electrical Components – Base Feed Module — Concealed Hardwire Connection	.104
BPM-1-C	Electrical Components — Hardwire – Blank Cover Plate	.118
CH-8	Panel Accessories – All-Purpose Hook	.94
CMPF-1-BR	Electrical and Cable Management Accessories – Cable Management Pole — One Channel	.115
CMPT-1-B	Electrical and Cable Management Accessories – Cable Management Pole — Two Channels	.115
E2AG	UniGroup Too Panels – Glazed Add-On Panel	.53
E2AL-1	Panel Accessories – UniGroup Too Top Cap Aligner	.61
E2AM	UniGroup Too Panels – Fabric Add-On Panel	.52
E2BN-B	UniGroup Too Panels – Monolithic Panel Core without Insert(s) — No Power	.42
E2BP-B	UniGroup Too Panels – Monolithic Panel Core without Insert(s) — Powered	.44
E2CA-120	Panel Accessories – 120° Square Painted Top Cap for 2-Way or 3-Way	.60
E2CC-90	Panel Accessories – 90° Square Painted Top Cap for 2-Way, 3-Way, 4-Way	.60
E2CH-8	Panel Accessories – All-Purpose Hook	.64
E2DS	Swing Door – Single Door — Laminate	.55
E2EC-1	Panel Accessories – UniGroup Too Top Cap End Plug	.61
E2FM	Electrical Components – Top Feed Module	.107
E2FM-NT	Electrical Components — Hardwire / International – Top Feed Module	.119
E2FM-X	Electrical Components – Top Feed Module	.107
E2FN-B	UniGroup Too Panels – Fabric Monolithic Panel — No Power	.24
E2FP-B	UniGroup Too Panels – Fabric Monolithic Panel — Powered	.27
E2GN-B	UniGroup Too Panels – Glazed Monolithic Panel — No Power	.46
E2GP-B	UniGroup Too Panels – Glazed Monolithic Panel — Powered	.48
E2JF	UniGroup Too Panels – Base Insert	.50
E2LN-B	UniGroup Too Panels – Monolithic Panel with Full-Height Inserts — No Power	.30
E2LP-B	UniGroup Too Panels – Monolithic Panel with Full-Height Inserts — Powered	.33
E2MN-B	UniGroup Too Panels – Basic Monolithic Panel — No Power	.18
E2MP-B	UniGroup Too Panels – Basic Monolithic Panel — Powered	.21
E2PA	Panel Accessories – 120° Full-Height Finish Post — Square Painted Top Cap	.57
E2PA-V	Panel Accessories – 120° Variable-Height Finish Post — Square Painted Top Cap	.57
E2PC	Panel Accessories – 90° Full-Height Finish Post — Square Painted Top Cap	.56
E2PC-120-B	Panel Accessories – 120° Power Connector Cover	.57
E2PC-90-B	Panel Accessories – 90° Power Connector Cover — Square Profile	.56
E2PC-V	Panel Accessories – 90° Variable-Height Finish Post — Square Painted Top Cap	.56
E2PS	Panel Accessories – 180° Full-Height Finish Post — Square Painted Top Cap	.58
E2PS-N	Panel Accessories – 180° Vertical Cover only, (no top cap or base raceway cover)	.59
E2PS-V	Panel Accessories – 180° Variable-Height Finish Post — Square Painted Top Cap	.58
E2SN-B	UniGroup Too Panels – Monolithic Panel with Segmented Inserts — No Power	.36
E2SP-B	UniGroup Too Panels – Monolithic Panel with Segmented Inserts — Powered	.39
E2TF	UniGroup Too Panels – Upper Inserts	.51
E2TK	Panel Accessories – T-Mount Kits	.64
E2TM	UniGroup Too Panels – Upper Inserts	.51
E2TS-P	Panel Accessories – Retrofit Kits – Square Painted Top Caps	.99

Index

Product Code	Product Description	Page
E2TS-T	Panel Accessories – Retrofit Kits – Square Painted Top Caps	.95
E2TS-U	Panel Accessories – Retrofit Kits – Square Painted Top Caps	.95
E2UR-A	Panel Accessories – Retrofit Kits – Trim Strip for UniGroup Fabric and Glazed Add-On Panels	.95
EAF	UniGroup Panels – Fabric Add-On Panel	.85
EAG	UniGroup Panels – Glazed Add-On Panel	.87
EBEJ-0072-3WF	Electrical Components – Raised Floor Base Feed Module	.105
EC-10-B	Electrical and Cable Management Accessories – Base Raceway End Cap	.114
EC-10-B	Panel Accessories – Base Raceway End Cap	.61
EDS-BHL	Swing Door with Steel Top Cap – Single Door — Laminated	.89
EFN-B	UniGroup Panels – Monolithic Panel with Steel Top Cap — No Power	.65
EFP-B	UniGroup Panels – Monolithic Panel with Steel Top Cap — Powered	.68
EGN-B	UniGroup Panels – Glazed Monolithic Panel with Steel Top Cap — No Power	.81
EGP-B	UniGroup Panels – Glazed Monolithic Panel with Steel Top Cap — Powered	.83
EMN-B	UniGroup Panels – Basic Monolithic Panel with Steel Top Cap — No Power	.71
EMP-B	UniGroup Panels – Basic Monolithic Panel with Steel Top Cap — Powered	.74
EON-B	UniGroup Panels – Open Frame Panel with Steel Top Cap — No Power	.77
EOP-B	UniGroup Panels – Open Frame Panel with Steel Top Cap — Powered	.79
ETOR	Electrical and Cable Management Accessories – Expanded Top Cap Raceway	.116
EVEJ-3WF	Electrical Components – Internal Power Base AI Feed	.105
FBEW	Electrical Components – Wall Feed Field Wired 1 Port	.106
FC-1	Electrical and Cable Management Accessories – Expanded Top Finish Cap	.116
FC-2	Electrical and Cable Management Accessories – Expanded Top Finish Cap	.116
FC-3	Electrical and Cable Management Accessories – Expanded Top Finish Cap	.116
FC-4	Electrical and Cable Management Accessories – Expanded Top Finish Cap	.116
FC-90	Electrical and Cable Management Accessories – Expanded Top Finish Cap	.116
FPC-2	Panel Accessories – Steel Top Cap for 3-Way and 4-Way	.91
FPPC-B	Panel Accessories – 90° Finish Post — for Steel Top Cap — Painted Surface	.90
FPPS-B	Panel Accessories – 180° Finish Post — for Steel Top Cap — Painted Surface	.91
H2PC	Panel Accessories – Retrofit Kits – 90° Full-Height Finish Post — Square Painted Top Cap	.99
H2PC-V	Panel Accessories – Retrofit Kits – 90° Variable-Height Finish Post — Square Painted Top Cap	.99
H2PS	Panel Accessories – Retrofit Kits – 180° Full-Height Finish Post — Square Painted Top Cap	.100
H2PS-V	Panel Accessories – Retrofit Kits – 180° Variable-Height Finish Post — Square Painted Top Cap	.100
HAB	Panel Accessories – Seismic Anchoring Bracket	.64
HAB	Panel Accessories – Seismic Anchoring Bracket	.94
HCT-0000	Electrical Components — International – Plastic Liner	.120
HE	Panel Accessories – Hinges	.63
HE	Panel Accessories – Hinges	.93
HGRY	Markerboards/Wall Accessory Slat Pad – Wall Accessory Slat Pad	.183
HNAM	Markerboards/Wall Accessory Slat Pad – Markerboard — Non-Magnetic Surface	.183
HTB	Tack Strips/Tackboards – Tack Board	.182
HTB	Tack Strips/Tackboards – Tack Strip	.182
KUAF	Wall Mount Components – Tackboard, Wall Mount	.179
KUAM	Wall Mount Components – Markerboard, Wall Mount	.179
KUP1-0000-CSN	Belong Work Tools Mounting Rails – For use with Adaptable Worksurfaces — Tool Rail — Single Post — C-Clamp or Thru-mount	.186
KUPY	Wall Mount Components – Slat, Wall Mount	.181
KUR1-1224-CSN	Belong Work Tools Mounting Rails – For use with Adaptable Worksurfaces — Tool Rail—Worksurface Mount C-Clamp or Thru-Mount	.185
LUTA	Lighting – Task — Adaptable LED Task Light – Add-On Kit	.190
LUTD-0017-INULDN	Lighting – Task — Reed Premiere™ Add-On LED Task Light	.188
LUTN	Lighting – Task — Adjustable LED Task Light – Stand-Alone	.189
LUTS-0000	Lighting – Task — Reed Premier™ Add-On Occupancy Sensor	.188

Index

Product Code	Product Description	Page
LUTS-0017-12ULD6	Lighting – Task — Reed Premier™ Starter LED Task Light	.187
LUTS-0017-19ULD5	Lighting – Task — Reed Premiere™ Stand-Alone LED Task Light	.187
LUTT	Lighting – Task — Adaptable LED Task Light – Starter Kit	.189
MAC-0001	Worksurface Supports – Make-A-Corner	.160
MEAM	Markerboards/Wall Accessory Slat Pad – Markerboard — Non-Magnetic Surface	.183
NADR-8	Shelf Accessories – Adaptable Shelf Dividers	.180
NADR-8	Upper Storage — Adaptable – Shelf Divider	.172
NEP-1	Electrical and Cable Management Accessories – Power Breaker Marker	.115
NUB-1	Upper Storage — Adaptable – Overhead Storage Unit / Shelf Gang Clip	.172
PCC-180-B	Panel Accessories – 180° Power Connector Cover — Radius Profile	.90
PCC-90-B	Panel Accessories – 90° Power Connector Cover	.90
PCF-3-B	Electrical Components – Flexible Power Connector — Panel-to-Panel	.109
PCOF-1-B	Electrical Components – Connector Assembly – 12” Pass-Through	.110
PCSS-3-B	Electrical Components – Flexible Power Connector — Straight Span	.110
PPC-180-B	Panel Accessories – 180° Power Connector Cover	.59
PRCN-B	Electrical Components – Ported Raceway Covers	.113
PRCP	Electrical Components — Hardwire – Raceway Covers	.118
PRCP-B	Electrical Components – Ported Raceway Covers	.113
PRD-2000-M13	Electrical Components – Duplex Receptacle – 20 Amp	.112
PRD-3-B	Electrical Components – Duplex Receptacle – 15 Amp	.111
PRDI-5-B	Electrical Components – Duplex Receptacle – 15 Amp	.111
RKN-B	Electrical Components – Raceway Retrofit Kit	.111
RKP-00-C	Electrical Components — Hardwire – Dual Power Access Raceway Kit — 4”-High Base Raceway	.118
RKP-3-LB	Electrical Components – Raceway Cover – 20 Amp	.112
RKP-3-LS	Electrical Components – Raceway Cover – 20 Amp	.112
RKP-B	Electrical Components – Raceway Retrofit Kit	.111
SPCL-1613	Clerestory Kits – 2-Way Connector Kit	.102
SPCL-1614	Clerestory Kits – 3-Way Connector Kit	.102
SPCL-1615	Clerestory Kits – 4-Way Connector Kit	.102
SPCL-1616	Clerestory Kits – Straight Track Kit	.102
SPCL-1622	Clerestory Kits – End Kit	.102
SRE	Panel Accessories – Side Trim Rail	.62
SRE	Panel Accessories – Side Trim Rail	.92
SREH	Panel Accessories – Full Height Side Trim Rail — for use with Add-On Panels	.62
SREH	Panel Accessories – Full-Height Side Trim Rails — for use with Add-On Panels	.92
TFM-B	Electrical Components – Top Feed Module — UniGroup Only	.108
TFM-NT	Electrical Components — Hardwire / International – Top Feed Module	.119
TFM-X	Electrical Components – Top Feed Module — UniGroup Only	.108
TMKT-B	Panel Accessories – T-Mount Kit — Center and End Conditions	.94
U2PA	Panel Accessories – Retrofit Kits – 120° Full-Height Finish Post — Square Painted Top Cap	.97
U2PA-V	Panel Accessories – Retrofit Kits – 120° Variable-Height Finish Post — Square Painted Top Cap	.97
U2PC	Panel Accessories – Retrofit Kits – 90° Full-Height Finish Post — Square Painted Top Cap	.96
U2PC-V	Panel Accessories – Retrofit Kits – 90° Variable-Height Finish Post — Square Painted Top Cap	.96
U2PS	Panel Accessories – Retrofit Kits – 180° Full-Height Finish Post — Square Painted Top Cap	.98
U2PS-V	Panel Accessories – Retrofit Kits – 180° Variable-Height Finish Post — Square Painted Top Cap	.98
UEFS-PM	Upper Storage — Adaptable – Overhead Storage Unit — Standard Mount	.162
UEGS-PM	Upper Storage — Adaptable – Overhead Storage Unit — Up Mount	.167
UEHF-QM	Upper Storage — Adaptable – Overhead Storage Unit — Standard Mount	.162
UEJS-PM	Upper Storage — Adaptable – Overhead Storage Unit — Up Mount	.167
UEKS-PM	Upper Storage — Adaptable – Overhead Storage Unit — Standard Mount	.162
UELS-PM	Upper Storage — Adaptable – Overhead Storage Unit — Up Mount	.167
UESN	Upper Storage — Adaptable – Open Shelf Standard Mount	.172

Index

Product Code	Product Description	Page
UESY-PM	Adaptable Upper Storage – Straight Mini Shelf, Standard Mount	.161
UUF8-P	Wall Mount Components – Back for Wall Mounted Overhead Storage Unit	.178
UUF8-PW	Wall Mount Components – Overhead Storage Unit — Wall Mount	.173
UUHF-QW	Wall Mount Components – Overhead Storage Unit — Wall Mount	.173
UUKS-PW	Wall Mount Components – Overhead Storage Unit — Wall Mount	.173
VEEH-3	Electrical Components – Infeed Harness	.106
VEZP	Panel Accessories – Filler Post — Sliding Door	.54
VUZF	Panel Accessories – Sliding Door	.54
WMK	Panel Accessories – Wall Mount Kit	.63
WMK	Panel Accessories – Wall Mount Kit	.93
WT	Panel Accessories – Wall Track	.63
WT	Panel Accessories – Wall Track	.93
WT	Wall Mount Components – Wall Track	.178
WUCA-L	Adaptable Worksurfaces — Corner – General Specifications	.130
WUCA-L	Adaptable Worksurfaces — Corner – Straight Front Corner – 90°	.133
WUCB-L54	Adaptable Worksurfaces — Corner – Bent	.131
WUCB-L54	Adaptable Worksurfaces — Corner – General Specifications	.130
WUCB-R45	Adaptable Worksurfaces — Corner – Bent	.131
WUCB-R45	Adaptable Worksurfaces — Corner – General Specifications	.130
WUCC-0004	Worksurface Supports – Straight Leg Basic	.158
WUCD-L	Adaptable Worksurfaces — Convergent – D-Shape Convergent Wrap-Around	.147
WUCD-L	Adaptable Worksurfaces — Convergent – General Specifications	.143
WUCE-L44	Adaptable Worksurfaces — Corner – General Specifications	.130
WUCE-L44	Adaptable Worksurfaces — Corner – Wrap-Around Extended Corner – 90° — Wrap-Around Extended/Wrap-Around Extended Transitional	.135
WUCE-R44	Adaptable Worksurfaces — Corner – General Specifications	.130
WUCE-R44	Adaptable Worksurfaces — Corner – Wrap-Around Extended Corner – 90° — Wrap-Around Extended/Wrap-Around Extended Transitional	.135
WUCF	Adaptable Worksurfaces — Corner – Angled Corner – 90° — Angled/Angled Transitional	.142
WUCF-L45	Adaptable Worksurfaces — Corner – Angled Corner – 90° — Angled/Angled Transitional	.142
WUCF-L45	Adaptable Worksurfaces — Corner – General Specifications	.130
WUCF-L54	Adaptable Worksurfaces — Corner – General Specifications	.130
WUCH-N34	Adaptable Worksurfaces — Corner – General Specifications	.130
WUCH-N34	Adaptable Worksurfaces — Corner – Notched Corner – 90° — Notched/Notched Transitional	.139
WUCH-N43	Adaptable Worksurfaces — Corner – General Specifications	.130
WUCH-N43	Adaptable Worksurfaces — Corner – Notched Corner – 90° — Notched/Notched Transitional	.139
WUCL-0001	Worksurface Supports – Straight Leg Basic	.158
WUCN	Adaptable Worksurfaces — Corner – General Specifications	.130
WUCN	Adaptable Worksurfaces — Corner – Notched Corner – 90° — Notched/Notched Transitional	.139
WUCP-L44	Adaptable Worksurfaces — Corner – General Specifications	.130
WUCP-L44	Adaptable Worksurfaces — Corner – Notched Extended Corner – 90°	.140
WUCP-R44	Adaptable Worksurfaces — Corner – General Specifications	.130
WUCP-R44	Adaptable Worksurfaces — Corner – Notched Extended Corner – 90°	.140
WUCQ-N44	Adaptable Worksurfaces — Corner – General Specifications	.130
WUCQ-N44	Adaptable Worksurfaces — Corner – Merger Corner – 90°	.132
WUCR	Adaptable Worksurfaces — Corner – General Specifications	.130
WUCR	Adaptable Worksurfaces — Corner – Wrap-Around Corner – 90° — Wrap-Around/Wrap-Around Transitional	.134
WUCT	Adaptable Worksurfaces — Corner – Wrap-Around Corner – 90° — Wrap-Around/Wrap-Around Transitional	.134
WUCT-N34	Adaptable Worksurfaces — Corner – General Specifications	.130
WUCT-N43	Adaptable Worksurfaces — Corner – General Specifications	.130
WUCU	Adaptable Worksurfaces — Corner – Angled Corner – 90° — Angled/Angled Transitional	.142
WUCU	Adaptable Worksurfaces — Corner – General Specifications	.130

Index

Product Code	Product Description	Page
WUCX-L43	Adaptable Worksurfaces — Corner – General Specifications	.130
WUCX-L43	Adaptable Worksurfaces — Corner – Wrap-Around Extended Corner – 90° — Wrap-Around Extended/Wrap-Around Extended Transitional	.135
WUCX-R34	Adaptable Worksurfaces — Corner – General Specifications	.130
WUCX-R34	Adaptable Worksurfaces — Corner – Wrap-Around Extended Corner – 90° — Wrap-Around Extended/Wrap-Around Extended Transitional	.135
WUDC	Adaptable Worksurfaces — Conference End – Conference End/Key Conference End	.149
WUDD	Adaptable Worksurfaces — Convergent – D-Shape Ender Convergent	.146
WUDD	Adaptable Worksurfaces — Convergent – General Specifications	.143
WUDZ	Adaptable Worksurfaces — 120° Link	.150
WUKC	Adaptable Worksurfaces — Adjustable Split Top – Corner — 90°	.153
WUKR	Adaptable Worksurfaces — Adjustable Split Top – Rectangular	.153
WURA	Adaptable Worksurfaces — Rectangular – General Specifications	.121
WURA	Adaptable Worksurfaces — Rectangular – Rectangular	.122
WURD	Adaptable Worksurfaces — Convergent – D-Shape Convergent	.145
WURD	Adaptable Worksurfaces — Convergent – General Specifications	.143
WURE-N34	Adaptable Worksurfaces — Rectangular – General Specifications	.121
WURE-N34	Adaptable Worksurfaces — Rectangular – Wedge/Sharp Wedge—Wedge/Sharp Wedge	.126
WURE-N43	Adaptable Worksurfaces — Rectangular – General Specifications	.121
WURE-N43	Adaptable Worksurfaces — Rectangular – Wedge/Sharp Wedge—Wedge/Sharp Wedge	.126
WURG-N34	Adaptable Worksurfaces — Rectangular – General Specifications	.121
WURG_N34	Adaptable Worksurfaces — Rectangular – Wedge/Sharp Wedge—Wedge/Sharp Wedge	.126
WURG-N43	Adaptable Worksurfaces — Rectangular – General Specifications	.121
WURG-N43	Adaptable Worksurfaces — Rectangular – Wedge/Sharp Wedge—Wedge/Sharp Wedge	.126
WURR	Adaptable Worksurfaces — Rectangular – General Specifications	.121
WURR	Adaptable Worksurfaces — Rectangular – Rectangular Radius End	.129
WURS	Adaptable Worksurfaces — Rectangular – General Specifications	.121
WURS	Adaptable Worksurfaces — Rectangular – Swell/Inverse Swell—Swell/Inverse Swell	.125
WURT-N34	Adaptable Worksurfaces — Rectangular – General Specifications	.121
WURT-N34	Adaptable Worksurfaces — Rectangular – Rectangular Transition	.124
WURT-N43	Adaptable Worksurfaces — Rectangular – General Specifications	.121
WURT-N43	Adaptable Worksurfaces — Rectangular – Rectangular Transition	.124
WURV	Adaptable Worksurfaces — Convergent – General Specifications	.143
WURV	Adaptable Worksurfaces — Convergent – Rectangular	.144
WURW	Adaptable Worksurfaces — Rectangular – General Specifications	.121
WURW	Adaptable Worksurfaces — Rectangular – Swell/Inverse Swell—Swell/Inverse Swell	.125
WURY	Adaptable Worksurfaces — Conference End – Conference End/Key Conference End	.149
WURY	Adaptable Worksurfaces — Rectangular Key	.151
WUTS	Adaptable Worksurfaces – Countertop	.152
Z2BT-0000	Worksurface Supports – Convergent Mount Bracket	.156
ZEBA-0000	Worksurface Supports – Side Bracket	.155
ZEBD-1000	Worksurface Supports – Standard Mini Cantilever Bracket	.154
ZEBD-1600	Worksurface Supports – Standard Cantilever Bracket	.154
ZEBF-0000-P	Worksurface Supports – Anti Dislodgement Bracket	.157
ZEBL-1600	Worksurface Supports – Standard Cantilever Link Cantilever Bracket	.154
ZEBN-0000	Worksurface Supports – Pedestal-to-Panel Bracket	.156
ZEBR-0000	Worksurface Supports – Convergent Mount Bracket	.155
ZEBT-0000	Worksurface Supports – Convergent Mount Bracket	.156
ZEBV-0000	Worksurface Supports – Convergent Mount Bracket	.155
ZEFS	Worksurface Supports – Worksurface Support Panels	.157
ZHBT-0000	Worksurface Supports – Convergent Mount Bracket	.156
ZUBF-0000	Worksurface Supports – Convergent Mount Bracket	.155

Index

<u>Product Code</u>	<u>Product Description</u>	<u>Page</u>
ZUBW	Wall Mount Components – Worksurface and Gallery Panel Wall Mount Bracket178
ZUFJ-0101-PNFG	Worksurface Supports – Single Support Leg159
ZZFJ	Worksurface Supports – Support Post159
ZZFK	Worksurface Supports – Double Support Leg159

Product Compatibility and Limited Warranty Policy

Great Expectations

You have them as a Haworth customer and so do we. And because we value our customers, we cover our products with the Haworth North America Product Compatibility and Limited Warranty Policy.

Our Commitment To Product Compatibility – Integrated Product Platforms

As a market leader in the design and manufacture of workspaces that adapt to change, we strive to maintain product compatibility within our various generations of integrated product platforms. This benefits the customer who desires to update or modify their work environment. It also benefits the customer needing to replace a product due to damage or other reasons but which is no longer manufactured or is otherwise unavailable, such as a fabric or finish that is discontinued because of changing market preferences. In both circumstances, we often can provide products with comparable function and performance.

Our Commitment To Product Quality – The Haworth North America Limited Warranty

To ensure customer satisfaction and peace of mind, we stand behind our products with the Haworth North America Limited Warranty. To review the current version of the limited warranty including its terms and conditions, please go to:

www.haworth.com/warranty or contact OneTouch@Haworth.com or 1 877 429 6784.

Warranty Requests or Questions

For questions or service requests pertaining to the Haworth Limited Warranty, please contact your Haworth dealer.

If you are unsure who your dealer is, please contact **OneTouch@Haworth.com or 1 877 429 6784.**

Terms of Sale

The Terms of Sale apply to all products in the North America Price Lists. To review the current version of the North American Terms of Sale, please go to:

www.haworth.com/terms-of-sale or contact OneTouch@Haworth.com or 1 877 429 6784.

HAWORTH

HAWORTH® is a registered trademark of Haworth, Inc.
© Haworth, Inc. All rights reserved. 2026 2.26
haworth.com | 800 344 2600