

Compose Storage

GSA Price List – February 2026



This price list is based upon Haworth's December 2025 commercial pricing.
GENERAL SERVICES ADMINISTRATION FEDERAL SUPPLY SERVICE
Authorized Federal Supply Scheduled Price List (Catalog) Office Furniture, Wood Casegoods and Tables
(FSC Group 71, Part I, FSC Classes 7105, 7110, 7125 and 7195)
Contract No: GS-O3F-057DA | Contract Period: February 28, 2026 – February 7, 2031 | Business: Large
Contractor: Haworth, Inc. | One Haworth Center | Holland, MI 49423-9576 | 1.616.393.3000





This Haworth North American price book contains US list prices.

Canadian customers can convert the US list price into their Canadian equivalent by going to www.Haworth.com/Canada to find the current Canadian multipliers. These multiplier factors allow you to convert the US list price into a Canadian list price.

HAWORTH, INC.

GENERAL SERVICES ADMINISTRATION

FEDERAL ACQUISITION SERVICES

Authorized Federal Supply Schedule Furniture (FSC Group 71, FSC Classes 7105, 7110, 7125 and 7195)

Contract Number:	GS-03F-057DA
Contract Start Date:	February 28, 2026
Contract End Date:	February 7, 2031
Contractor:	HAWORTH, INC. One Haworth Center Holland, MI 49423-9576 1-616-393-3000 http://www.haworth.com/government
Business Size:	Large

Information for Ordering Activities I-FSS-600

Online access to Haworth's Authorized Federal Supply Schedule contract ordering information, terms and conditions, and up-to-date product and discount listing can be found at GSA Advantage, eLibrary link [here](#).



This Page Intentionally Left Blank

Compose Storage Price List

Includes pricing, catalog numbers, finish codes/availability, specification requirements, line art, dimensions, and specification tips for Compose Storage.

Modular Lower Storage

Storage Tops

Freestanding Storage

Upper Storage

Table of Contents

Price List

Statement of Line 7-9

Modular Lower Storage

- Mobile Pedestals 10
- Attached/Freestanding Pedestals 12
- Pedestal Accessories 14
- Pedestal Cushion 14
- Pencil Tray 14
- Storage-to-Panel Bracket 14
- Attached or Freestanding Lateral File 15
- Attached or Freestanding Lateral File with Open Shelf 17
- Combination Unit 19
- Lateral File and Storage Accessories 21
- File/Storage Cushion 21
- Storage-to-Panel Bracket 21
- Lateral File Hanging Bar 21

Storage Tops

- Individual/Common 22
- Continuous 23
- Off-Modular 24

Freestanding Storage

- Double Hinged Door Storage Cabinet 25
- Open Storage Cabinet 27
- Side Bookcase Storage Cabinet 29
- Personal Storage Tower with Wardrobe Bookcase Upper Storage 31
- Wardrobe 33

Upper Storage

- Stack-On Storage 35

Finished Back 37

Worksurface Support End 38

Resources

Surface Materials

- Finish/Color Legend 40

Index 42

Lifetime Product Warranty Inside Back Cover

Statement of Line

Mobile Pedestals

Page 10



Exposed Caster Base
Box/File Pedestal

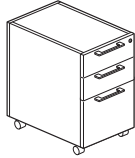

Exposed Caster Base
Box/Box/File Pedestal

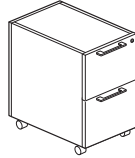

Exposed Caster Base
File/File Pedestal

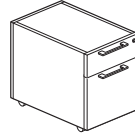

Side Panel Caster Base
Box/File Pedestal

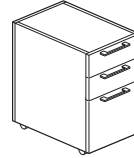

Side Panel Caster Base
Box/Box/File Pedestal

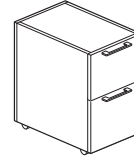

Side Panel Caster Base
File/File Pedestal

Attached/Freestanding Pedestals

Page 12

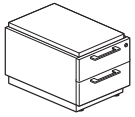

Box/Box Pedestal

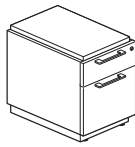

Box/File Pedestal

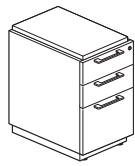

Box/Box/File Pedestal

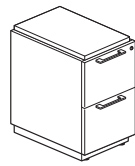

File/File Pedestal

Pedestal Accessories

Page 14



Pedestal Cushion

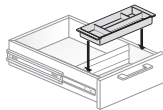

Pencil Tray

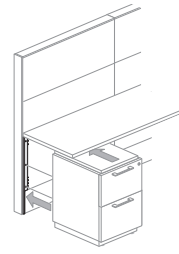

Storage-to-Panel Bracket

Lateral File

Page 15

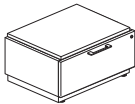

1H Lateral File

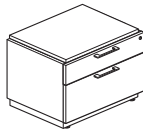

1.5H Lateral File

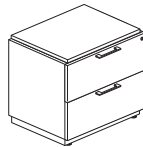

2H Lateral File



3H Lateral File

Lateral File with Open Shelf

Page 17

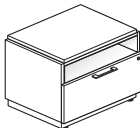

1.5H Open Shelf Lateral File

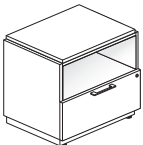

2H Open Shelf Lateral File

Combination Unit

Page 19

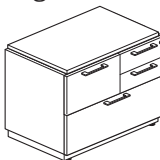

Right Hand Combination Unit

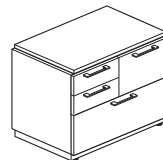

Left Hand Combination Unit

Statement of Line

Lateral File and Storage Accessories

Page 21

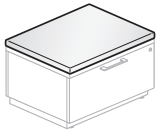

File/Storage Cushion

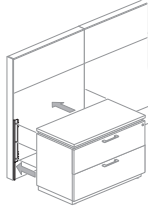

Storage-to-Panel Bracket

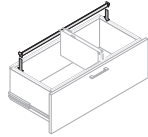

Lateral File Hanging Bar

Storage Tops

Pages 22-24



Individual/Common



Individual/Common

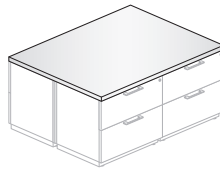

Individual/Common

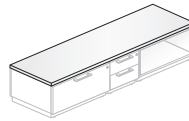

Continuous

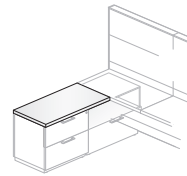

Off-Modular

Storage Cabinet

Pages 25-28

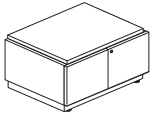

1H Storage Unit with Doors

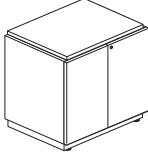

2H Storage Unit with Doors

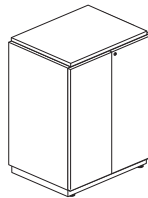

3H Storage Unit with Doors

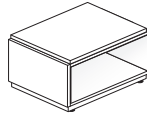

1H Storage Unit without Doors

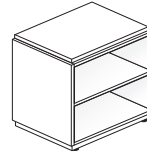

2H Storage Unit without Doors

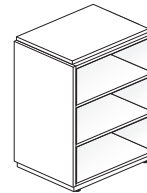

3H Storage Unit without Doors

Personal Storage Tower

Pages 29-32

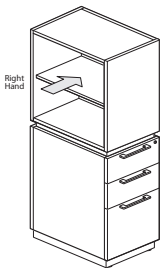

Side Bookcase - Right Hand

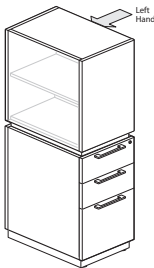

Side Bookcase - Left Hand

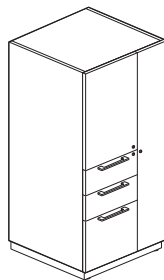

Wardrobe - Right Hand

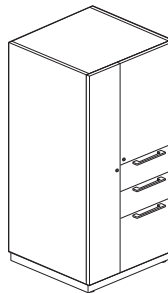

Wardrobe - Left Hand

Statement of Line

Wardrobes

Pages 33-34



Locking Right Hand Swing Wardrobe

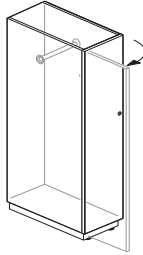

Locking Left Hand Swing Wardrobe

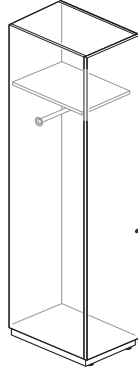

Locking Left Hand Swing Wardrobe

Stack-on Storage

Pages 35-36

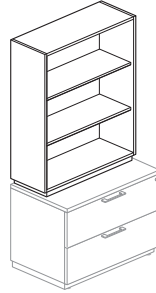

Without Doors Stack-on Storage

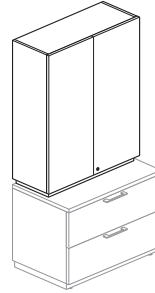

Full Height Doors Stack-on Storage

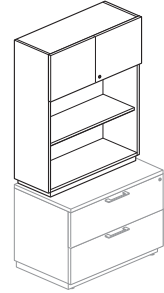

Partial Doors on Top Stack-on Storage

Finished Back

Page 37

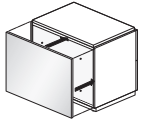

Finished Back

Worksurface Support End

Page 38

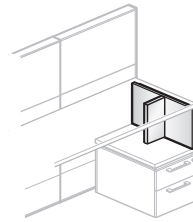

End

Modular Lower Storage – Mobile Pedestals

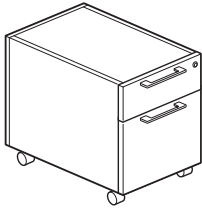

BZMA-CLN

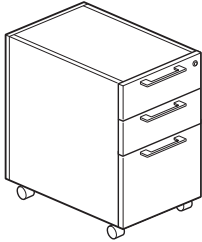

BZMH-CLN

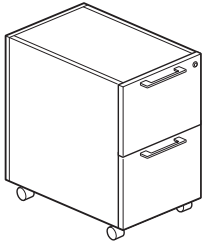

BZMJ-CLN

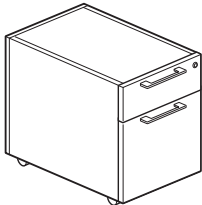

BZMA-GLN

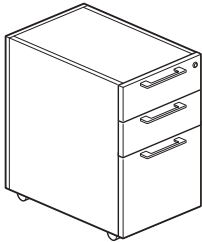

BZMH-GLN

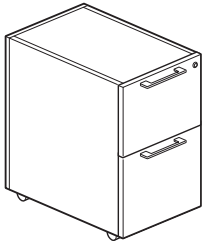

BZMJ-GLN
Class TA

Features

- Mobile Pedestals include:
 - Drawer pull options.
 - Exposed caster base or side panel base with casters options.
 - Black miterfold drawer interiors.
 - High-Pressure Laminate (HPL) case with back and High-Pressure Laminate (HPL) drawer fronts. Case edgeband matches drawer front edgeband.
- Box drawers include one black plastic divider each.
- One black plastic pencil tray included with Box/File or Box/Box/File pedestal.
- File drawer includes integrated file hanging system for letter front-to-back filing.
- All drawers have full extension slides.
- Standard with lock; lock plugs available in chrome or black.
- For lock options, refer to Lock Program section of the Accessories Price List.
- Drawer Pull Options:
 - Crescent (7), Linear (8) and Classic (9) pulls standard in Brushed Nickel finish (no specification required).
 - Integrated Aluminum J-Pull (K); aluminum finger pull requires trim color.
- Base Options:
 - Exposed Caster Base (C); includes two front locking swivel casters and two rear non-locking swivel casters.
 - Side Panel Base (G); includes four non-locking swivel casters; sides/front extend to floor visually hiding casters.
- Casters are standard in black and not height adjustable.
- Standard with installed counterweight.
- Case ships partially assembled, finished back and casters field installed.

Specification Tips

- Mobile pedestal back and top are finished and intended for visual exposure.
- Cushion may be separately specified; recommended for use with a box/file pedestal.
- Refer to Specification Guide for planning information.

To Order, Specify:

1) Product number, including:

1 Pull Options:

7 Crescent

8 Linear

9 Classic

K Aluminum J-Pull

2) Case laminate surface color.

3) Lock plug trim color.

4) Aluminum J-Pull trim color, if applicable.

5) Laminate case edge trim color.

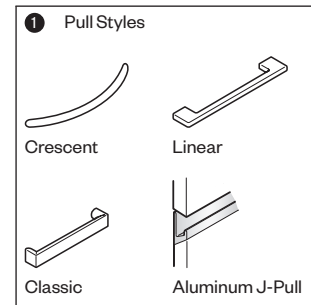

Modular Lower Storage – Mobile Pedestals

Actual Height	Actual Depth	Actual Width	Description	Pull	Number	①	HPL A	B
Exposed Caster Base								
20.2"(513mm)	17.68"(449mm)	15.5"(394mm)	Box/File	7,8,9	BZMA-1816-LLB	CLN	\$ 2287.11	\$ 2375.88
				K	BZMA-1816-LLBKCLN		2574.00	2662.77
20.2"(513mm)	23.68"(601mm)	15.5"(394mm)	Box/File	7,8,9	BZMA-2416-LLB	CLN	\$2342.28	\$ 2431.05
				K	BZMA-2416-LLBKCLN		2629.17	2717.94
26.2"(665mm)	17.68"(449mm)	15.5"(394mm)	Box/Box/File	7,8,9	BZMH-1816-LLB	CLN	\$ 2541.45	\$2650.61
				K	BZMH-1816-LLBKCLN		2971.80	3080.96
26.2"(665mm)	23.68"(601mm)	15.5"(394mm)	Box/Box/File	7,8,9	BZMH-2416-LLB	CLN	\$2598.81	\$ 2707.97
				K	BZMH-2416-LLBKCLN		3029.16	3138.32
26.2"(665mm)	17.68"(449mm)	15.5"(394mm)	File/File	7,8,9	BZMJ-1816-LLB	CLN	\$2390.64	\$ 2487.70
				K	BZMJ-1816-LLBKCLN		2677.53	2774.59
26.2"(665mm)	23.68"(601mm)	15.5"(394mm)	File/File	7,8,9	BZMJ-2416-LLB	CLN	\$2442.39	\$ 2539.45
				K	BZMJ-2416-LLBKCLN		2729.28	2826.34
Side Panel Caster Base								
20.9"(531mm)	17.68"(449mm)	15.5"(394mm)	Box/File	7,8,9	BZMA-1816-LLB	GLN	\$ 2287.11	\$ 2375.88
				K	BZMA-1816-LLBKGLN		2574.00	2662.77
20.9"(531mm)	23.68"(601mm)	15.5"(394mm)	Box/File	7,8,9	BZMA-2416-LLB	GLN	\$2342.28	\$ 2431.05
				K	BZMA-2416-LLBKGLN		2629.17	2717.94
26.9"(683mm)	17.68"(449mm)	15.5"(394mm)	Box/Box/File	7,8,9	BZMH-1816-LLB	GLN	\$ 2541.45	\$2650.61
				K	BZMH-1816-LLBKGLN		2971.80	3080.96
26.9"(683mm)	23.68"(601mm)	15.5"(394mm)	Box/Box/File	7,8,9	BZMH-2416-LLB	GLN	\$2598.81	\$ 2707.97
				K	BZMH-2416-LLBKGLN		3029.16	3138.32
26.9"(683mm)	17.68"(449mm)	15.5"(394mm)	File/File	7,8,9	BZMJ-1816-LLB	GLN	\$2390.64	\$ 2487.70
				K	BZMJ-1816-LLBKGLN		2677.53	2774.59
26.9"(683mm)	23.68"(601mm)	15.5"(394mm)	File/File	7,8,9	BZMJ-2416-LLB	GLN	\$2442.39	\$ 2539.45
				K	BZMJ-2416-LLBKGLN		2729.28	2826.34

Modular Lower Storage – Attached/Freestanding Pedestals

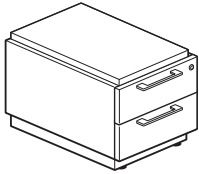

BZPX

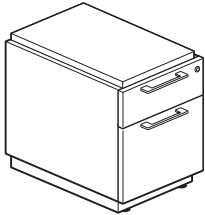

BZPA

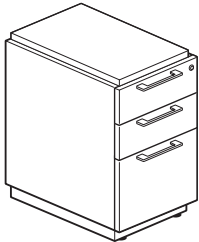

BZPH

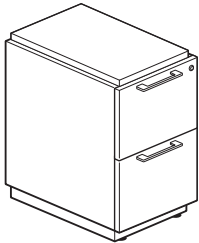

BZPJ

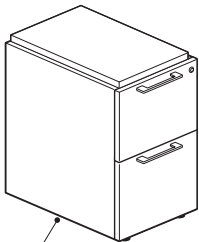

Side Panel Base

Note: Graphics shown with solid spacer.
Class TA

Features

- Pedestals include:
 - Attachment hardware when applicable.
 - Base or leg and drawer pull options.
 - Floating spacer option has a finished top.
 - Solid spacer option has an unfinished top.
 - High-Pressure Laminate (HPL) case with back and High-Pressure Laminate (HPL) drawer fronts. Case edgeband matches drawer front edgeband.
- Box drawers include one black plastic divider each.
- One black plastic pencil tray included with Box/Box, Box/File or Box/Box/File pedestal.
- File drawer includes integrated file hanging system for letter front-to-back filing.
- All drawers have full extension slides.
- Standard with lock; lock plugs available in chrome or black.
- For lock options, refer to Lock Program section of the Accessories Price List.
- Drawer Pull Options:
 - Crescent (7), Linear (8) and Classic (9) pulls standard in Brushed Nickel finish (no specification required).
 - Integrated Aluminum J Pull (K); aluminum finger pull requires trim color.
- Base/Leg Options:
 - Side Panel Base (E); sides/front extend to floor; side panels are part of case
 - Plinth Base with plastic edge (L); requires edge trim color
 - Chamfer Leg (P); requires trim color.
- Glide height adjustment ranges:
 - Chamfer leg - 1.25”(32mm)
 - Side Panel Base/Plinth Base - 2”(51mm)
- Spacer Options:
 - Floating Spacer (F); requires trim color (finished top).
 - Solid Spacer with plastic edge (L); requires edge trim color (unfinished top).
 - No Spacer (U); no surface specification required (unfinished top).
 - No Spacer (N); no surface specification required (finished top)
- Counterweight Option: (18”(457mm)D only)
 - Yes, counterweight is factory installed.
 - No, no counterweight.
- Floating and solid spacers are 1.19”(30mm)H.
- Case (with/without optional Counterweight) ships assembled; Spacers and Plinth Base/Legs require field installation.

Specification Tips

- Finished Back is separately specified when pedestal back is exposed.
- 2H box/box/file or file/file pedestal requires a solid or floating spacer for a 29”(737mm)H Adaptable worksurface application.
- For panel mounted applications; separately specify appropriate attachment brackets for support and load purposes.
- Pedestals:
 - with solid spacer are not intended for use with a knife edge Adaptable worksurface due to dimensional differences.
 - without spacer with finished or unfinished top may be used in a slip-fit or nested Adaptable worksurface application.
 - without spacer are for use with edgeband Adaptable worksurface only; not intended for use with knife edges due to dimensional differences.
 - 24”/30”(610-762mm)D do not require counterweight.
- Counterweight: (18”(457mm)D only)
 - may be used in pedestals with or without a separately specified finished back.
 - is required in a freestanding 2H box/box/file or file/file pedestal
 - is not required in pedestals attached to an Adaptable worksurface.
 - is not required for a 1H box/box pedestal.
- Cushion may be separately specified for a freestanding pedestal; recommended for use with a 1H box/box pedestal.
- Refer to Pedestal Cushion page for planning information.

To Order, Specify:

1) Product number, including:

1 Pull Options:

- 7** Crescent
- 8** Linear
- 9** Classic
- K** Aluminum J-Pull

2 Base/Leg Options:

- E** Side Panel Base
- L** Plinth Base/Plastic Edge (add **\$326.42** list)
- P** Chamfer Leg (add **\$180.04** list)

3 Spacer Options:

- F** Floating Spacer/finished top:
 - 18”(457mm)D (add **\$253.82** list)
 - 24”(610mm)D (add **\$280.30** list)
 - 30”(762mm)D (add **\$297.97** list)

- L** Solid Spacer/Plastic Edge/unfinished top (add **\$203.02** list)

- U** No Spacer/unfinished top.

- N** No Spacer/finished top.

4 Counterweight Option (18”(457mm)D only):

- Y** Yes (add **\$110.30** list)
- N** No

2) Case laminate surface color.

3) Base/Leg trim color.
Side Panel Base (E) - (No finish specification.)
Plinth Base (L) - Edge trim color.
Chamfer (P) - Trim color.

4) Spacer trim color.
Floating Spacer (F) - Trim color.
Solid Spacer (L) - Edge trim color.

5) Lock plug trim color.

6) Aluminum J-Pull trim color, if applicable.

7) Laminate case trim color.

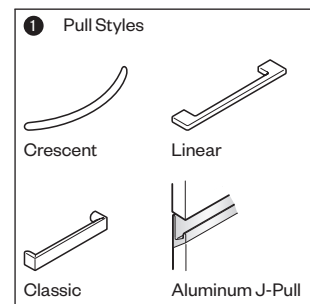

Modular Lower Storage – Attached/Freestanding Pedestals

Height No Spacer	Actual Height W/Spacer	Actual Depth Inset Back*	Actual Width	Description	Pull	Number	①②③④			HPL	
							L	N		A	B
14.8"(376mm)	16"(406mm)	16.93"(430mm)	15.5"(394mm)	Box/Box	7,8,9	BZPX-1816-LLB	L			\$ 1560.00	\$ 1641.73
						K	BZPX-1816-LLBK	L		1846.89	1928.62
14.8"(376mm)	16"(406mm)	22.93"(582mm)	15.5"(394mm)	Box/Box	7,8,9	BZPX-2416-LLB	L	N		\$ 1615.17	\$ 1696.90
						K	BZPX-2416-LLBK	L	N	1902.06	1983.79
20.9"(531mm)	22.0"(559mm)	16.93"(430mm)	15.5"(394mm)	Box/File	7,8,9	BZPA-1816-LLB	L			\$ 1647.81	\$ 1736.58
						K	BZPA-1816-LLBK	L		1934.70	2023.47
20.9"(531mm)	22.0"(559mm)	22.93"(582mm)	15.5"(394mm)	Box/File	7,8,9	BZPA-2416-LLB	L	N		\$ 1702.98	\$ 1791.75
						K	BZPA-2416-LLBK	L	N	1989.87	2078.64
26.9"(683mm)	28.1"(714mm)	16.93"(430mm)	15.5"(394mm)	Box/Box/File	7,8,9	BZPH-1816-LLB	L			\$ 1902.15	\$ 2011.31
						K	BZPH-1816-LLBK	L		2332.50	2441.66
26.9"(683mm)	28.1"(714mm)	22.93"(582mm)	15.5"(394mm)	Box/Box/File	7,8,9	BZPH-2416-LLB	L	N		\$ 1959.51	\$ 2068.67
						K	BZPH-2416-LLBK	L	N	2389.86	2499.02
26.9"(683mm)	28.1"(714mm)	28.93"(735mm)	15.5"(394mm)	Box/Box/File	7,8,9	BZPH-3016-LLB	L	N		\$ 2016.92	\$ 2126.08
						K	BZPH-3016-LLBK	L	N	2447.27	2556.43
26.9"(683mm)	28.1"(714mm)	16.93"(430mm)	15.5"(394mm)	File/File	7,8,9	BZPJ-1816-LLB	L			\$ 1751.34	\$ 1848.40
						K	BZPJ-1816-LLBK	L		2038.23	2135.29
26.9"(683mm)	28.1"(714mm)	22.93"(582mm)	15.5"(394mm)	File/File	7,8,9	BZPJ-2416-LLB	L	N		\$ 1803.09	\$ 1900.15
						K	BZPJ-2416-LLBK	L	N	2089.98	2187.04
26.9"(683mm)	28.1"(714mm)	28.93"(735mm)	15.5"(394mm)	File/File	7,8,9	BZPJ-3016-LLB	L	N		\$ 1854.87	\$ 1951.93
						K	BZPJ-3016-LLBK	L	N	2141.76	2238.82

*Inset back unfinished.

Modular Lower Storage – Pedestal Accessories

Pedestal Cushion



BZSC-F
Class TA

Features

- Includes one 1.25"(32mm) thick cushion with removable attachment.
- Pedestal cushions are dimensioned to accommodate units with inset back (S) or separately specified proud finished back (A).
- Field installed.
- COM yardage:
18"(457mm) x 16"(406mm) - 1.1 yards
24"(610mm) x 16"(406mm) - 1.4 yards
30"(762mm) x 16"(406mm) - 1.7 yards

Specification Tips

- For use with Compose mobile or freestanding pedestals.
- Pedestal Cushion:
–May be used on pedestals with finished or unfinished tops and on top of attached Compose Storage Top.
–May not be placed directly on top of spacers.
- Not for use with X Series or V Series storage.
- Storage top is not required for use with Pedestal Cushion.
- Refer to Specification Guide for planning information.

To Order, Specify:

- 1) Product number, including:
 - ❶ **Unit Back Option:**
 - A** Proud Finished Back
 - S** Inset Unfinished Back
- 2) Fabric and color.

Actual Height	Nominal Depth	Actual Width	Number ❶	Fabric				
				A	B	C	D	E
1.25"(32mm)	18"(457mm)	15.5"(394mm)	BZSC-1816-F	\$ 988.22	\$ 1136.78	\$1303.37	\$1483.48	\$1661.28
1.25"(32mm)	24"(610mm)		BZSC-2416-F	1118.80	1287.62	1457.26	1640.53	1821.47
1.25"(32mm)	30"(762mm)		BZSC-3016-F	1249.38	1438.46	1611.15	1797.58	1981.66

Pencil Tray

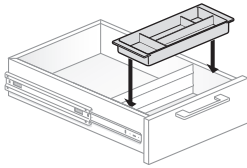

JPTA-6
Class RA

Features

- Includes one black plastic tray.
- Suspends from sides of 6"(152mm) drawer and slides for drawer access.

To Order, Specify:

- 1) Product number.
(No finish specification required.)

Height	Depth	Width	Number	Price
1.25"(32mm)	5.5"(140mm)	112.87"(305mm)	JPTA-6	\$59.70

Storage-to-Panel Bracket

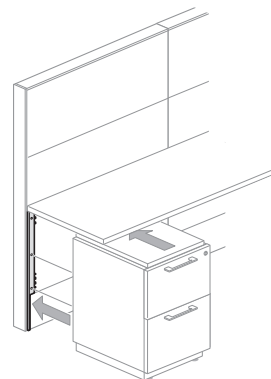

BZBG
Class TA

Features

- Includes one bracket and mounting screws.
- Installs into panel frame attachment slots and attaches to back side of lower storage or full height storage.
- Non-handed.
- **Installation requires field drilling which will deface storage unit or finished back.**

Specification Tips

- For use with 2H and 3H storage units and full height storage with Chamfer leg, plinth or side panel bases; height specific product number.
- Worksurface and lower storage unit must be same nominal depth.
- Designed for use with edgeband worksurfaces.
- **Not for use with:**
 - Knife edge worksurfaces
 - X Series or V Series storage
- For use with lower storage with unfinished insert back or separately specified finished proud back.
- Refer to Specification Guide for planning information.

To Order, Specify:

- 1) Product number.
- 2) Trim color.

Description	Number	Trim	
		A	B
For use with pedestal/ 2H storage	BZBG-0002	\$186.85	\$197.89
For use with pedestal/ 3H storage/ full height storage	BZBG-0003	186.85	197.89

Modular Lower Storage – Lateral File

Attached or Freestanding

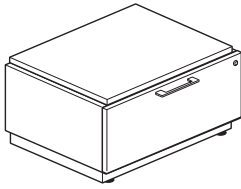

BZL1

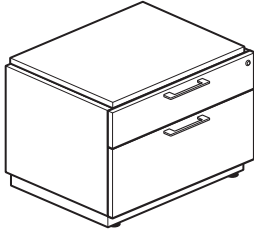

BZLA

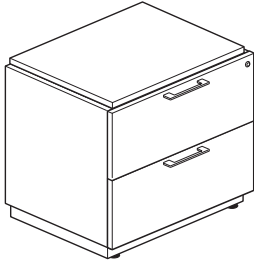

BZL2

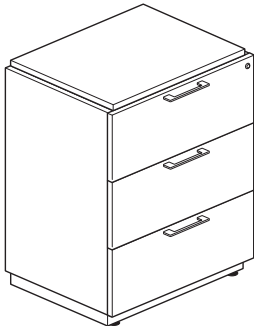

BZL3
Class TA

Features

- Lateral Files include:
 - Base or leg and drawer pull options.
 - Floating spacer option has a finished top.
 - Solid spacer option has an unfinished top.
 - Black miterfold drawer interiors.
 - High-Pressure Laminate (HPL) case with back and High-Pressure Laminate (HPL) drawer fronts. Case edgeband matches drawer front edgeband.
- File drawer includes integrated file hanging system and two file hangar bars per drawer.
 - 18"(457mm)D x 30"(762mm)W: letter front-to-back
 - 18"(457mm)D x 36"(914mm)W: letter/legal front-to-back
 - 24"(610mm) x 30"(762mm)D: letter front-to-back or legal side-to-side
 - 24"(610mm)D x 36"(914mm)W: letter/legal front-to-back or legal side-to-side
- Note - 1H Lateral File will accommodate a Pendaflex file folder without tabs. File drawer will not close if tabs are used.
- All drawers have full extension slides.
- Standard with lock; lock plugs available in chrome or black.
- For lock options, refer to Lock Program section of the Accessories Price List.
- Drawer Pull Options:
 - Crescent (7), Linear (8) and Classic (9) pulls standard in Brushed Nickel finish (no specification required).
 - Integrated Aluminum J-Pull (K); aluminum finger pull requires trim color. J-Pull not available on 1.5H Lateral File.
- Base/Leg Options:
 - Side Panel Base (E); sides/front extend to floor; side panels are part of case.
 - Plinth Base with plastic edge (L); requires edge trim color.
 - Chamfer leg (P); requires trim color.
- Glide height adjustment ranges:
 - Chamfer leg - 1.25"(32mm)
 - Side Panel Base/Plinth Base - 2"(51mm)
- Spacer Options:
 - Floating Spacer (F); requires trim color (finished top).
 - Solid Spacer with plastic edge (L); requires edge trim color (unfinished top).
 - No Spacer (U); no surface specification required (unfinished top).
 - No Spacer (N); no surface specification required (finished top).
- Counterweight Option (Not available on 3H Lateral Files):
 - Yes, counterweight is factory installed.
 - No, no counterweight.
- Floating and solid spacers are 1.19"(25mm)H.
- Case (with/without optional Counterweight) ships assembled; Spacers and Plinth Base/Legs require field installation.

Specification Tips

- Finished Back is separately specified when lateral file back is exposed.
- 2H lateral file requires a solid or floating spacer for a 29"(737mm)H Adaptable worksurface application.
- For panel mounted applications; separately specify appropriate attachment brackets for support and load purposes.
- Lateral Files:
 - with solid spacer are not intended for use with a knife edge Adaptable worksurface due to dimensional differences.
 - without spacer with finished or unfinished top may be used in a slip-fit or nested Adaptable worksurface application.
 - without spacer are for use with edgeband Adaptable worksurface only; not intended for use with knife edge due to dimensional differences.
- Counterweight:
 - may be used in lateral files with or without a separately specified finished back.
 - is required in freestanding lateral files.
 - is not needed when two or more units are attached to a Compose Common/ Continuous Storage Top or are ganged together with attachment hardware.
 - is not required in a panel mounted application when lateral file is attached to an Adaptable worksurface.
- Stack-on Storage:
 - may be used with 1H or 2H lateral file
 - lateral file and stack-on to be same width
 - not for use with 3H lateral file
- Cushion may be separately specified; recommended for use with a 1H lateral file.

To Order, Specify:

1) Product number, including:

1 Pull Options:

- 7** Crescent
- 8** Linear
- 9** Classic
- K** Aluminum J-Pull

2 Base/Leg Options:

- E** Side Panel Base
- L** Plinth Base/Plastic Edge (add **\$551.52** list)
- P** Chamfer Leg (add **\$180.04** list)

3 Spacer Options:

- F** Floating Spacer/finished top 18"(457mm)D (add **\$253.82** list)
- 24"(610mm)D (add **\$280.30** list)

- L** Solid Spacer/Plastic Edge/unfinished top (add **\$353.11** list)

- U** No Spacer/unfinished top
- N** No Spacer/finished top

4 Counterweight Option:

- Y** Yes (add **\$110.30** list)
- N** No

2) Case laminate surface color.

3) Base/Leg trim color.

Side Panel Base (E) - (No finish specification.)

Plinth Base (L) - Edge trim color.

Chamfer (P) - Trim color.

4) Spacer trim color.

Floating Spacer (F) - Trim color.

Solid Spacer (L) - Edge trim color.

5) Lock plug trim color.

6) Aluminum J-Pull trim color, if applicable.

7) Laminate case edge trim color.

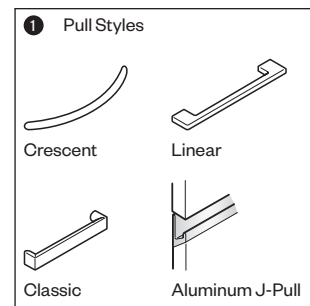

Modular Lower Storage – Lateral File

Attached or Freestanding

Actual Height No Spacer	Actual Height W/Spacer	Actual Depth Inset Back*	Actual Width	Pull	Number	① ② ③ ④	HPL	
							A	B
1H								
14.8"(376mm)	16"(406mm)	16.93"(430mm)	29.88"(759mm)	7,8,9	BZL1-1830-LLB	■ L ■ ■	\$ 2170.02	\$2300.57
				K	BZL1-1830-LLBK	■ L ■ ■	2313.45	2444.00
14.8"(376mm)	16"(406mm)	16.93"(430mm)	35.88"(911mm)	7,8,9	BZL1-1836-LLB	■ L ■ ■	\$2399.63	\$2530.18
				K	BZL1-1836-LLBK	■ L ■ ■	2543.06	2673.61
14.8"(376mm)	16"(406mm)	22.93"(582mm)	29.88"(759mm)	7,8,9	BZL1-2430-LLB	■ L ■ ■	\$2356.92	\$ 2487.47
				K	BZL1-2430-LLBK	■ L ■ ■	2500.35	2630.90
14.8"(376mm)	16"(406mm)	22.93"(582mm)	35.88"(911mm)	7,8,9	BZL1-2436-LLB	■ L ■ ■	\$2586.53	\$ 2717.08
				K	BZL1-2436-LLBK	■ L ■ ■	2729.96	2860.51
1.5H								
20.9"(531mm)	22"(559mm)	16.93"(430mm)	29.88"(759mm)	7,8,9	BZLA-1830-LLB	■ L ■ ■	\$2780.08	\$2959.48
20.9"(531mm)	22"(559mm)	16.93"(430mm)	35.88"(911mm)	7,8,9	BZLA-1836-LLB	■ L ■ ■	\$3079.24	\$3258.64
20.9"(531mm)	22"(559mm)	22.93"(582mm)	29.88"(759mm)	7,8,9	BZLA-2430-LLB	■ L ■ ■	\$3005.86	\$ 3185.26
20.9"(531mm)	22"(559mm)	22.93"(582mm)	35.88"(911mm)	7,8,9	BZLA-2436-LLB	■ L ■ ■	\$3305.02	\$3484.42
2H								
26.9"(683mm)	28"(711mm)	16.93"(430mm)	29.88"(759mm)	7,8,9	BZL2-1830-LLB	■ L ■ ■	\$2980.51	\$ 3158.28
				K	BZL2-1830-LLBK	■ L ■ ■	3267.40	3445.17
26.9"(683mm)	28"(711mm)	16.93"(430mm)	35.88"(911mm)	7,8,9	BZL2-1836-LLB	■ L ■ ■	\$ 3272.71	\$3450.48
				K	BZL2-1836-LLBK	■ L ■ ■	3559.60	3737.37
26.9"(683mm)	28"(711mm)	22.93"(582mm)	29.88"(759mm)	7,8,9	BZL2-2430-LLB	■ L ■ ■	\$3202.71	\$3380.48
				K	BZL2-2430-LLBK	■ L ■ ■	3489.60	3667.37
26.9"(683mm)	28"(711mm)	22.93"(582mm)	35.88"(911mm)	7,8,9	BZL2-2436-LLB	■ L ■ ■	\$3494.91	\$3672.68
				K	BZL2-2436-LLBK	■ L ■ ■	3781.80	3959.57
3H								
38.9"(988mm)	40.1"(1019mm)	16.93"(430mm)	29.88"(759mm)	7,8,9	BZL3-1830-LLB	■ L ■ N	\$ 4123.89	\$ 4410.83
				K	BZL3-1830-LLBK	■ L ■ N	4554.24	4841.18
38.9"(988mm)	40.1"(1019mm)	16.93"(430mm)	35.88"(911mm)	7,8,9	BZL3-1836-LLB	■ L ■ N	\$4946.65	\$ 5233.59
				K	BZL3-1836-LLBK	■ L ■ N	5377.00	5663.94
38.9"(988mm)	40.1"(1019mm)	22.93"(582mm)	29.88"(759mm)	7,8,9	BZL3-2430-LLB	■ L ■ N	\$5336.99	\$5623.93
				K	BZL3-2430-LLBK	■ L ■ N	5767.34	6054.28
38.9"(988mm)	40.1"(1019mm)	22.93"(582mm)	35.88"(911mm)	7,8,9	BZL3-2436-LLB	■ L ■ N	\$ 6159.75	\$6446.69
				K	BZL3-2436-LLBK	■ L ■ N	6590.10	6877.04

*Inset Back Unfinished

Modular Lower Storage – Lateral File with Open Shelf Attached or Freestanding

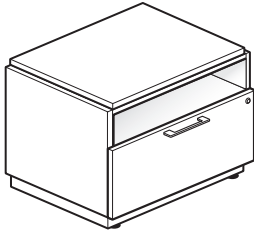

BZLV

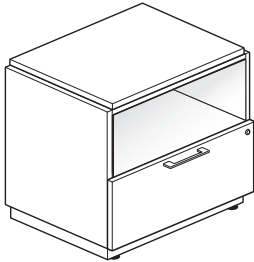

BZLZ
Cass TA

Features

- Open Shelf Lateral Files include:
 - Fixed shelf with finished interior.
 - Base or leg and drawer pull options.
 - Floating spacer option has a finished top.
 - Solid spacer option has an unfinished top.
 - Black miterfold drawer interior.
 - High-Pressure Laminate (HPL) case with back and High-Pressure Laminate (HPL) drawer fronts. Case edgeband matches drawer front edgeband.
- Open Shelf interior dimensions:
 - 1.5H = 5.3"(135mm)H
 - 2H = 11.3"(287mm)H
 - 30"(762mm) = 28.38"(721mm)W
 - 36"(914mm) = 34.38"(873mm)W
- File drawer includes integrated file hanging system and two file hangar bars.
 - 18"(457mm)D x 30"(762mm)W: letter front-to-back
 - 18"(457mm)D x 36"(914mm)W: letter/legal front-to-back
 - 24"(610mm)D x 30"(762mm)W: letter front-to-back or legal side-to-side
 - 24"(610mm)D x 36"(914mm)W: letter/legal front-to-back or legal side-to-side
- Note - The lateral file drawer will accommodate a Pendaflex file folder without tabs. File drawer will not close if tabs are used. Exception: 2H unit with Side Panel Base, option (E), will accommodate tabs.
- All drawers have full extension slides.
- Standard with lock; lock plugs available in chrome or black.
- For lock options, refer to Lock Program section of the Accessories Price List.
- Drawer Pull Options:
 - Crescent (7), Linear (8) and Classic (9) pulls standard in Brushed Nickel finish (no specification required).
 - Integrated Aluminum J-Pull (K); aluminum finger pull requires trim color.
- Base/Leg Options:
 - Side Panel Base (E); sides/front extend to floor; side panels are part of case.
 - Plinth Base with plastic edge (L); requires edge trim color.
 - Chamfer leg (P); requires trim color.
- Glide height adjustment ranges:
 - Chamfer leg - 1.25"(32mm)
 - Side Panel Base/Plinth Base - 2"(51mm)
- Spacer Options:
 - Floating Spacer (F); requires trim color (finished top).
 - Solid Spacer with plastic edge (L); requires edge trim color (unfinished top).
 - No Spacer (U); no surface specification required (unfinished top).
 - No Spacer (N); no surface specification required (finished top).
- Counterweight Option:
 - Yes, counterweight is factory installed.
 - No, no counterweight.
- Floating and solid spacers are 1.19"(30mm)H.
- Case (with/without optional Counterweight) ships assembled; Spacer and Plinth Base/Legs require field installation.

Specification Tips

- Finished Back is separately specified when lateral file back is exposed.
- Open shelf lateral file requires a solid or floating spacer for a 29"(737mm)H Adaptable worksurface.
- For panel mounted applications; separately specify appropriate attachment brackets for support and load purposes.
- Open Shelf Lateral Files:
 - with solid spacer are not intended for use with a knife edge Adaptable worksurface due to dimensional differences
 - without spacer with finished or unfinished top may be used in a slip-fit or nested Adaptable worksurface application
 - without spacer are for use with edgeband Adaptable worksurface only; not intended for use with knife edge due to dimensional differences
- Counterweight:
 - may be used in lateral files with or without a separately specified finished back.
 - is required in a freestanding open shelf lateral file.
 - is not needed when two or more units are attached to a Compose Common/Continuous Storage Top or are ganged together with attachment hardware.
 - is not required in a panel mounted application when an open shelf lateral file is attached to an Adaptable worksurface.
- Stack-on Storage:
 - may be used with open shelf lateral file;
 - lateral file and stack-on to be same width.
- Refer to Specification Guide for planning information.

To Order, Specify:

1) Product number, including:

1 Pull Options:

- 7** Crescent
- 8** Linear
- 9** Classic
- K** Aluminum J-Pull

2 Base/Leg Options:

- E** Side Panel Base
- L** Plinth Base/Plastic Edge (add **\$551.52** list)
- P** Chamfer Leg (add **\$180.04** list)

3 Spacer Options:

- F** Floating Spacer/finished top 18"(457mm)D (add **\$253.82** list)
- 24"(610mm)D (add **\$280.30** list)

- L** Solid Spacer/Plastic Edge/unfinished top (add **\$353.11** list)

- U** No Spacer/unfinished top
- N** No Spacer/finished top

4 Counterweight Option:

- Y** Yes (add **\$110.30** list)
- N** No

2) Case laminate surface color.

3) Base/Leg trim color.
Side Panel Base (E) - (No finish specification.)
Plinth Base (L) - Edge trim color.
Chamfer (P) - Trim color.

4) Spacer trim color.
Floating Spacer (F) - Trim color.
Solid Spacer (L) - Edge trim color.

5) Lock plug trim color.

6) Aluminum J-Pull trim color, if applicable.

7) Laminate case edge trim color.

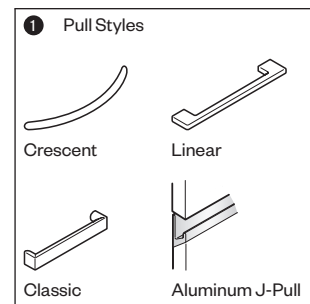

Modular Lower Storage – Lateral File with Open Shelf Attached or Freestanding

Actual Height No Spacer	Actual Height W/Spacer	Actual Depth Inset Back*	Actual Width	Pull	Number	① ② ③ ④	HPL A	B
1.5H								
20.9"(531mm)	22"(559mm)	16.93"(430mm)	29.88"(759mm)	7,8,9	BZLV-1830-LLB	■ ■ L ■ ■	\$ 2331.53	\$ 2472.26
				K	BZLV-1830-LLBK	■ L ■ ■ ■	2474.96	2615.69
20.9"(531mm)	22"(559mm)	16.93"(430mm)	35.88"(911mm)	7,8,9	BZLV-1836-LLB	■ ■ L ■ ■	\$ 2561.81	\$ 2702.54
				K	BZLV-1836-LLBK	■ L ■ ■ ■	2705.24	2845.97
20.9"(531mm)	22"(559mm)	22.93"(582mm)	29.88"(759mm)	7,8,9	BZLV-2430-LLB	■ ■ L ■ ■	\$2502.93	\$2643.66
				K	BZLV-2430-LLBK	■ L ■ ■ ■	2646.36	2787.09
20.9"(531mm)	22"(559mm)	22.93"(582mm)	35.88"(911mm)	7,8,9	BZLV-2436-LLB	■ ■ L ■ ■	\$ 2733.21	\$ 2873.94
				K	BZLV-2436-LLBK	■ L ■ ■ ■	2876.64	3017.37
2H								
26.9"(683mm)	28"(711mm)	16.93"(430mm)	29.88"(759mm)	7,8,9	BZLV-1830-LLB	■ ■ L ■ ■	\$2552.08	\$2692.81
				K	BZLV-1830-LLBK	■ L ■ ■ ■	2695.51	2836.24
26.9"(683mm)	28"(711mm)	16.93"(430mm)	35.88"(911mm)	7,8,9	BZLV-1836-LLB	■ ■ L ■ ■	\$2782.36	\$2923.09
				K	BZLV-1836-LLBK	■ L ■ ■ ■	2925.79	3066.52
26.9"(683mm)	28"(711mm)	22.93"(582mm)	29.88"(759mm)	7,8,9	BZLV-2430-LLB	■ ■ L ■ ■	\$ 2723.48	\$2864.21
				K	BZLV-2430-LLBK	■ L ■ ■ ■	2866.91	3007.64
26.9"(683mm)	28"(711mm)	22.93"(582mm)	35.88"(911mm)	7,8,9	BZLV-2436-LLB	■ ■ L ■ ■	\$2953.76	\$3094.49
				K	BZLV-2436-LLBK	■ L ■ ■ ■	3097.19	3237.92

*Unfinished Inset Back

Modular Lower Storage – Combination Unit

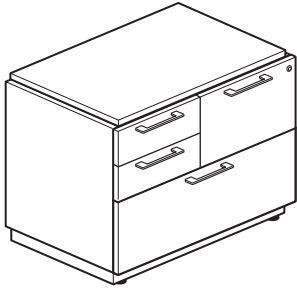

BZLB

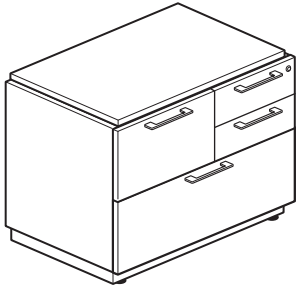

BZLC

Note: Graphics shown with solid spacer.
See features for file drawer capabilities.
Class TA

Features

- Combination Units include:
 - Base or leg and drawer pull options.
 - Floating spacer option has a finished top.
 - Solid spacer option has an unfinished top.
 - Black miterfold drawer interiors.
 - High-Pressure Laminate (HPL) case with back and High-Pressure Laminate (HPL) drawer fronts. Case edgeband matches drawer front edgeband.
- Box drawers include one black plastic divider each.
- One black plastic pencil tray included with Box/Box drawer.
- File drawer includes integrated file hanging system and two file hangar bars per drawer.
 - Pedestal drawer: Letter: Front-to-back
 - 18"(457mm)D x 36"(914mm)W: letter/legal front-to-back
 - 24"(610mm)D x 36"(914mm)W: letter/legal front-to-back or legal side-to-side
- Note - The upper file drawer will accommodate Pendaflex file folders with tabs. The lower lateral file drawer will accommodate a Pendaflex file folder without tabs. Lower file drawer will not close if tabs are used.
- All drawers have full extension slides.
- Standard with single lock; lock plugs available in chrome or black.
- For lock options, refer to Lock Program section of the Accessories Price List.
- Drawer pull options:
 - Crescent (7), Linear (8) and Classic (9) pulls are Brushed Nickel finish (no specification required).
 - Integrated Aluminum J-Pull (K); aluminum finger pull requires trim color.
- Base/Leg Options:
 - Side Panel Base (E); sides/front extend to floor; side panels are part of case.
 - Plinth Base with plastic edge (L); requires edge trim color.
 - Chamfer leg (P); requires trim color.
- Glide height adjustment ranges:
 - Chamfer leg - 1.25"(32mm)
 - Side Panel Base/Plinth Base - 2"(51mm)
- Spacer Options:
 - Floating Spacer (F); requires trim color.
 - Solid Spacer with plastic edge (L); requires edge trim color.
 - No Spacer (U); no surface specification required (unfinished top).
 - No Spacer (N); no surface specification required (finished top).
- Counterweight Option:
 - Yes, counterweight is factory installed.
 - No, no counterweight (attached only).
- Floating and solid spacers are 1.19"(30mm)H.
- Orientation of box/box drawers **is represented by one of the following letters as the fourth-digit.**
 - (C) right-hand side of unit.
 - (B) left-hand side of unit.
- Case (with/without optional Counterweight) ships assembled; Spacer and Base/Legs require field installation.

Specification Tips

- Finished back is separately specified when combination unit back is exposed.
- Requires a solid or floating spacer for a 29"(737mm)H Adaptable worksurface application.
- For panel mounted applications; separately specify appropriate attachment brackets for support and load purposes.
- Combination Unit:
 - with solid spacer is not intended for use with a knife edge Adaptable worksurface due to dimensional differences.
 - without spacer with finished or unfinished top may be used in a slip-fit or nested Adaptable worksurface application.
 - without spacer is for use with edgeband Adaptable worksurface only; not intended for use with knife edges due to dimensional differences.
- Orientation of drawer configuration is not field changeable.
- Counterweight:
 - may be used in combination unit with or without a separately specified finished back.
 - is required in a freestanding combination unit.
 - is not needed when two or more units are attached to a Compose Common/Continuous Storage Top or are ganged together with attachment hardware.
 - is not required in a panel mounted application when combination unit is attached to an Adaptable worksurface.
- Stack-on Storage:
 - may be used with combination units; combination unit and stack-on unit to be same width.
- Refer to Specification Guide for planning information.

To Order, Specify:

1) Product number, including:

1 Pull Options:

- 7** Crescent
- 8** Linear
- 9** Classic
- K** Aluminum J-Pull

2 Base/Leg Options:

- E** Side Panel Base
- L** Plinth Base/Plastic Edge (add **\$551.52** list)
- P** Chamfer Leg (add **\$180.04** list)

3 Spacer Options:

- F** Floating Spacer/finished top 18"(457mm)D (add **\$253.82** list) 24"(610mm)D (add **\$280.30** list)
- L** Solid Spacer/Plastic Edge/unfinished top (add **\$353.11** list)
- U** No Spacer/unfinished top
- N** No Spacer/finished top

4 Counterweight Option:

- Y** Yes (add **\$110.30** list)
- N** No

2) Case laminate surface color.

3) Base/Leg trim color.

Side Panel Base (E) - (No finish specification.)

Plinth Base (L) - Edge trim color.

Chamfer (P) - Trim color.

4) Spacer trim color.

Floating Spacer (F) - Trim color.

Solid Spacer (L) - Edge trim color.

5) Lock plug trim color.

6) Aluminum J-Pull trim color, if applicable.

7) Laminate case edge trim color.

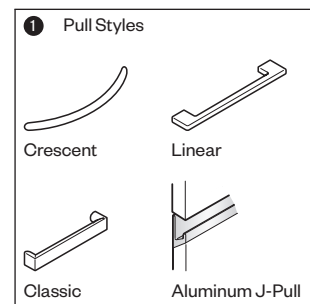

Modular Lower Storage – Combination Unit

Actual Height No Spacer	Actual Height W/Spacer	Actual Depth Inset Back*	Actual Width	Pull	Number	① ② ③ ④	HPL A	B
Right Hand								
26.9"(683mm)	28"(711mm)	16.93"(430mm)	35.875"(911mm)	7,8,9	BZLC-1836-LLB	■ L ■ ■	\$2845.35	\$3029.94
				K	BZLC-1836-LLBK	■ L ■ ■	3275.70	3460.29
26.9"(683mm)	28"(711mm)	22.93"(582mm)	35.875"(911mm)	7,8,9	BZLC-2436-LLB	■ L ■ ■	\$2892.63	\$ 3077.22
				K	BZLC-2436-LLBK	■ L ■ ■	3322.98	3507.57
Left Hand								
26.9"(683mm)	28"(711mm)	16.93"(430mm)	35.875"(911mm)	7,8,9	BZLB-1836-LLB	■ L ■ ■	\$2845.35	\$3029.94
				K	BZLB-1836-LLBK	■ L ■ ■	3275.70	3460.29
26.9"(683mm)	28"(711mm)	16.93"(430mm)	35.875"(911mm)	7,8,9	BZLB-2436-LLB	■ L ■ ■	\$2892.63	\$ 3077.22
				K	BZLB-2436-LLBK	■ L ■ ■	3322.98	3507.57

*Unfinished Inset Back

Modular Lower Storage – Lateral File and Storage Accessories

File/Storage Cushion

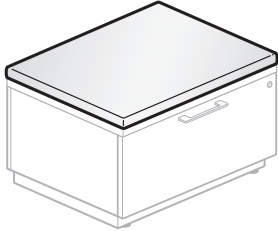

BZSC-F
Class TA

Features

- Includes one 1.25"(32mm) thick cushion with removable attachment.
- File/Storage cushions are dimensioned to accommodate units with insert back (S) or separately specified proud finished back (A).
- Field installed.
- COM yardage:
18"(457mm) x 30"(762mm) - 1.9 yards
18"(457mm) x 36"(914mm) - 2.2 yards
24"(610mm) x 30"(762mm) - 2.5 yards
24"(610mm) x 36"(914mm) - 2.6 yards

Specification Tips

- For use with Compose Storage.
- File/Storage Cushion:
–Must be used on top of attached Compose Storage top.
–May not be placed directly on top of spacers or finished/unfinished tops.
- Not for use with X Series or V Series storage.
- Separately specified storage top is required for use with Lateral File cushion.
- Refer to Specification Guide for planning information.

To Order, Specify:

- 1) Product number, including:
 - 1 **Unit Back Option:**
 - A** Proud Finished Back
 - S** Inset Unfinished Back
- 2) Fabric and color.

Actual Height	Nominal Depth	Actual Width	Number ①	Fabric				
				A	B	C	D	E
1.25"(32mm)	18"(457mm)	29.88"(759mm)	BZSC-1830-F	\$1043.72	\$1256.93	\$1432.82	\$1623.28	\$ 1811.28
	24"(610mm)		BZSC-2430-F	1219.32	1452.79	1631.73	1825.35	2016.49
1.25"(32mm)	18"(457mm)	35.88"(911mm)	BZSC-1836-F	\$1065.92	\$1304.99	\$1484.60	\$1679.20	\$ 1871.28
	24"(610mm)		BZSC-2436-F	1241.52	1500.85	1683.51	1881.27	2076.49

Storage-to-Panel Bracket

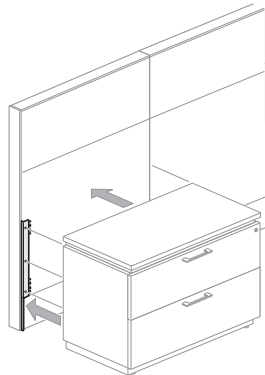

BZBG
Class TA

Features

- Includes one bracket and mounting screws.
- Installs into panel frame attachment slots and attaches to back side of lower storage or full height storage.
- Non-handed.
- **Installation requires field drilling which will deface storage unit or finished back.**

Specification Tips

- For use with 2H- and 3H storage units and full height storage with Chamfer leg, plinth or side panel bases; height specific product number.
- Worksurface and lower storage unit must be same nominal depth.
- Designed for use with edgeband worksurfaces.
- **Not for use with:**
 - Knife edge worksurfaces
 - X Series or V Series storage
- For use with lower storage with unfinished insert back or separately specified finished proud back.
- Refer to Specification Guide for planning information.

To Order, Specify:

- 1) Product number.
- 2) Trim color.

Description	Number	Trim	
		A	B
2H storage	BZBG-0002	\$186.85	\$197.89
3H storage/ full height storage	BZBG-0003	186.85	197.89

Lateral File Hanging Bar

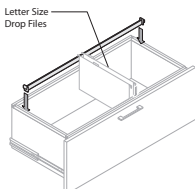

BZAH
Class TA

Features

- Includes one side-to-side hanging bar.
- Allows for side-to-side letter filing in lateral file drawer.
- Standard in black finish color only.

To Order, Specify:

- 1) Product number.
(No finish specification required.)

Width	Number	Price
30"(762mm)	BZAH-0030	\$28.67
36"(914mm)	BZAH-0036	33.09

Individual/Common Storage Tops



BZTR-1830

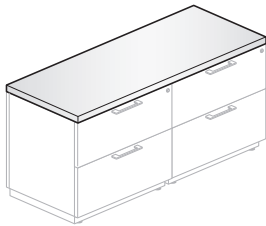

BZTR-1860

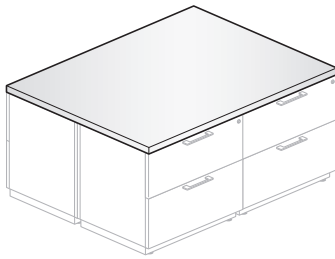

BZTR-3660
Class RA

Features

- Includes 1.18"(30mm) thick Individual or Common Storage Top and attachment hardware.
- High-Pressure Laminate (HPL) surface with 3mm edgeband on front and back edge; 1mm edgeband on sides.
- Available for storage applications with inset unfinished back or separately specified proud finished back; specify accordingly.
- Common storage tops require all storage units to have the same back option; inset unfinished backs or separately specified proud finished backs.
- Storage tops are dimensioned to accommodate storage units with inset back or separately specified proud finished attached back:
 - Specify "S" to accommodate storage unit with inset unfinished back.
 - Specify "A" to accommodate storage units with separately specified proud finished back.

Specification Tips

- Dimensioned for use with Compose Storage only; freestanding application.
- Individual Storage Top for use with a single pedestal, a single storage unit, a single file; lateral, combination or open shelf.
- Common Storage Top is for use with two side-by-side lower storage units in a single row; application may be mirrored for a back-to-back application. For use with storage units or files; lateral, combination or open shelf.
- All storage units must have the same back option in a common storage top application.
- May be used on lower storage with or without spacer.
- Refer to Specification Guide for planning information.

To Order, Specify:

- 1) Product number, including:
 - 1 Unit Back Option:**
 - A** Proud Finished Back
 - S** Inset Unfinished Back
- 2) Laminate surface color.
- 3) Edge trim color.

Nominal Depth	Actual Depth Proud	Actual Depth Inset	Nominal Width	Number	①	HPL	
						A	B
18"(457mm)	17.68"(449mm)	16.93"(430mm)	16"(406mm)	BZTR-1816-LJS	S	\$ 198.61	\$ 322.20
			30"(762mm)	BZTR-1830-LJS	S	269.87	393.46
			36"(914mm)	BZTR-1836-LJS	S	300.41	424.00
			60"(1524mm)	BZTR-1860-LJS	S	422.57	546.16
			66"(1676mm)	BZTR-1866-LJS	S	453.11	576.70
			72"(1829mm)	BZTR-1872-LJS	S	483.65	607.24
24"(610mm)	23.68"(601mm)	22.93"(582mm)	16"(406mm)	BZTR-2416-LJS	S	\$ 221.11	\$ 344.70
			30"(762mm)	BZTR-2430-LJS	S	307.37	430.96
			36"(914mm)	BZTR-2436-LJS	S	345.41	469.00
			60"(1524mm)	BZTR-2460-LJS	S	497.57	621.16
			66"(1676mm)	BZTR-2466-LJS	S	535.61	659.20
			72"(1829mm)	BZTR-2472-LJS	S	573.65	697.24
30"(762mm)	29.68"(754mm)	28.93"(735mm)	16"(406mm)	BZTR-3016-LJS	S	\$ 243.61	\$ 367.20
36"(914mm)	35.36"(898mm)	33.86"(860mm)	30"(762mm)	BZTR-3630-LJS	S	\$ 382.37	\$ 505.96
			36"(914mm)	BZTR-3636-LJS	S	435.41	559.00
			60"(1524mm)	BZTR-3660-LJS	S	647.57	771.16
			66"(1676mm)	BZTR-3666-LJS	S	700.61	824.20
			72"(1829mm)	BZTR-3672-LJS	S	753.65	877.24
48"(1219mm)	47.36"(1203mm)	45.86"(1165mm)	30"(762mm)	BZTR-4830-LJS	S	\$ 457.37	\$ 580.96
			36"(914mm)	BZTR-4836-LJS	S	525.41	649.00
			60"(1524mm)	BZTR-4860-LJS	S	797.57	921.16
			66"(1676mm)	BZTR-4866-LJS	S	865.61	989.20
			72"(1829mm)	BZTR-4872-LJS	S	933.65	1057.24

Continuous Storage Tops

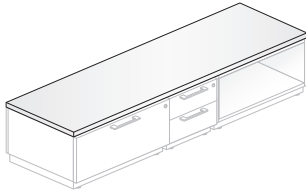

BZTB-1862
Class TA

Features

- Includes 1.18" (30mm) thick Continuous Storage Top and attachment hardware.
- High-Pressure Laminate (HPL) surface with 3mm edgeband on front and back edge; 1mm edgeband on sides.
- Available for storage applications with inset unfinished back or separately specified proud finished back; specify accordingly.
- Continuous storage tops require all storage units to have the same back option; inset unfinished backs or separately specified proud finished backs.

Specification Tips

- Dimensioned for use with Compose Storage only; freestanding application. For use with pedestal, storage unit or file; lateral, combination or open shelf.
- Continuous Storage Top is for use with three side-by-side lower storage units in a single row application.
- Storage tops are dimensional to accommodate storage units with an inset unfinished back or separately specified proud finished attached back.
 - Specify "S" to accommodate storage unit with inset unfinished back.
 - Specify "A" to accommodate storage unit with separately specified proud finished back.
- All storage units must have the same back option in a continuous storage top application.
- May be used on lower storage with or without spacer.
- Refer to Specification Guide for additional planning information.

To Order, Specify:

- 1) Product number, including:
 - 1 Unit Back Option:**
 - A** Proud Finished Back
 - S** Inset Unfinished Back
- 2) Laminate surface color.
- 3) Edge trim color.

Continuous Storage Top Accommodates

Width	Storage Combined Widths
62"	16"/16"/30"
68"	16"/16"/36"
76"	16"/30"/30"
88"	16"/36"/36"
90"	30"/30"/30"
96"	30"/30"/36"
102"	36"/36"/30"
108"(A8)	36"/36"/36"

Nominal Depth	Actual Depth Proud	Actual Depth Inset	Nominal Width	Number	①	HPL A	B
Side-by-Side							
18"(457mm)	17.68"(449mm)	16.93"(430mm)	62"(1575mm)	BZTB-1862-LJS	S	\$432.75	\$556.34
			68"(1727mm)	BZTB-1868-LJS	S	463.29	586.88
			76"(1930mm)	BZTB-1876-LJS	S	504.01	627.60
			88"(2235mm)	BZTB-1888-LJS	S	565.09	688.68
			90"(2286mm)	BZTB-1890-LJS	S	575.27	698.86
			96"(2438mm)	BZTB-1896-LJS	S	605.81	729.40
			102"(2591mm)	BZTB-18A2-LJS	S	636.35	759.94
			108"(2743mm)	BZTB-18A8-LJS	S	666.89	790.48
24"(610mm)	23.68"(601mm)	22.93"(582mm)	62"(1575mm)	BZTB-2462-LJS	S	\$ 515.25	\$638.84
			68"(1727mm)	BZTB-2468-LJS	S	553.29	676.88
			76"(1930mm)	BZTB-2476-LJS	S	601.51	725.10
			88"(2235mm)	BZTB-2488-LJS	S	677.59	801.18
			90"(2286mm)	BZTB-2490-LJS	S	687.77	811.36
			96"(2438mm)	BZTB-2496-LJS	S	725.81	849.40
			102"(2591mm)	BZTB-24A2-LJS	S	763.85	887.44
			108"(2743mm)	BZTB-24A8-LJS	S	801.89	925.48

Off-Modular Storage Tops

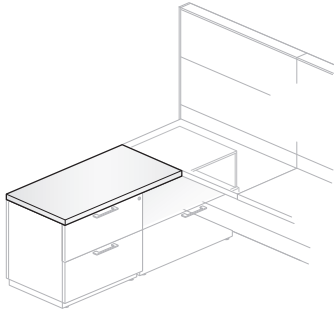

BZTM-1836
Class TA

Features

- Includes 1.18" (30mm) thick Off-Modular Storage Top and attachment hardware.
- High-Pressure Laminate (HPL) surface with 3mm edgeband on front and back edge; 1mm edgeband on sides.
- Available for nested storage applications with inset unfinished backs or separately specified proud finished backs; specify accordingly.
- Off-Modular storage tops require all storage units have the same back option; inset unfinished backs or a separately specified proud finished backs.

Specification Tips

- Dimensioned for use with Compose Storage only. For use with storage units or files; lateral, combination or open shelf.
- Designed for a nested storage application; a portion of the lower storage application is nested beneath a 1.19" (30mm) thick panel mounted Adaptable worksurface.
- Off-Modular Storage Top is for use with:
 - two side-by-side lower storage units in a single row; one storage unit is nested beneath a panel mounted adaptable worksurface.
 - two side-by-side lower storage units in a mirrored application; two storage units are nested beneath a panel mounted adaptable worksurface.
- Off-Modular Storage tops are dimensioned to accommodate storage units with an inset unfinished back or separately specified proud finished attached back:
 - Specify "S" to accommodate storage unit with inset unfinished back.
 - Specify "A" to accommodate storage unit with separately specified proud finished back.
- All storage units must have the same back option in an off-modular storage top application.
- Refer to Specification Guide for planning information.

To Order, Specify:

- 1) Product number, including:
 - 1 Unit Back Option:**
 - A** Proud Finished Back
 - S** Inset Unfinished Back
- 2) Laminate surface color.
- 3) Edge trim color.

Nominal Depth	Actual Depth Proud	Actual Depth Inset	Nominal Width	Number	1	HPL A	B
18" (457mm)	17.68" (449mm)	16.93" (430mm)	30" (762mm)	BZTM-1830-LJS	S	\$269.87	\$393.46
			36" (914mm)	BZTM-1836-LJS	S	300.41	424.00
			42" (1067mm)	BZTM-1842-LJS	S	330.95	454.54
			48" (1219mm)	BZTM-1848-LJS	S	361.49	485.08
			54" (1372mm)	BZTM-1854-LJS	S	392.03	515.62
24" (610mm)	23.68" (601mm)	22.93" (582mm)	30" (762mm)	BZTM-2430-LJS	S	\$ 307.37	\$430.96
			36" (914mm)	BZTM-2436-LJS	S	345.41	469.00
			42" (1067mm)	BZTM-2442-LJS	S	383.45	507.04
			48" (1219mm)	BZTM-2448-LJS	S	421.49	545.08
			54" (1372mm)	BZTM-2454-LJS	S	459.53	583.12
36" (914mm)	35.36" (898mm)	33.86" (860mm)	30" (762mm)	BZTM-3630-LJS	S	\$382.37	\$505.96
			36" (914mm)	BZTM-3636-LJS	S	435.41	559.00
			42" (1067mm)	BZTM-3642-LJS	S	488.45	612.04
			48" (1219mm)	BZTM-3648-LJS	S	541.49	665.08
			54" (1372mm)	BZTM-3654-LJS	S	594.53	718.12
48" (1219mm)	47.36" (1203mm)	45.86" (1165mm)	30" (762mm)	BZTM-4830-LJS	S	\$ 457.37	\$580.96
			36" (914mm)	BZTM-4836-LJS	S	525.41	649.00
			42" (1067mm)	BZTM-4842-LJS	S	593.45	717.04
			48" (1219mm)	BZTM-4848-LJS	S	661.49	785.08
			54" (1372mm)	BZTM-4854-LJS	S	729.53	853.12

Freestanding Storage – Storage Cabinet

Double Hinged Door

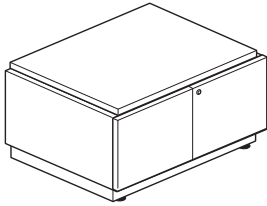

BZSS-LL1T

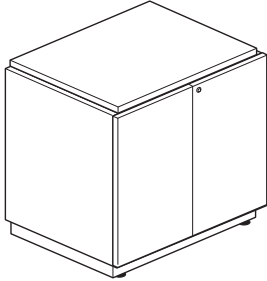

BZSS-LL2T

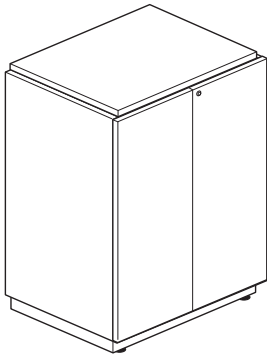

BZSS-LL3T

Note: Graphics shown with solid spacer and plinth base.
Class TA

Features

- Storage Units with doors include:
 - Standard with finished interior.
 - Base or leg options.
 - Floating spacer option has a finished top.
 - Solid spacer option has an unfinished top.
 - High-Pressure Laminate (HPL) case with unfinished inset back and High-Pressure Laminate (HPL) touch-latch doors.
 - Shelves are 0.75”(19mm) thick and adjust 1.26”(32mm) up or down only.
 - 1H: open interior storage.
 - 2H: one adjustable shelf.
 - 3H: two adjustable shelves.
 - Interior height dimension is based upon leg/base option chosen; refer to Specification Guide.
 - Base/Leg Options:
 - Side Panel Base (E); sides/front extend to floor; side panels are part of case.
 - Plinth Base with plastic edge (L); requires edge trim color.
 - Chamfer leg (P); requires trim color.
 - Glide adjustment range:
 - Side Panel Base: 1”(25mm).
 - Plinth Base/Chamfer Leg: 1.25”(32mm).
 - Lock plugs available in chrome or black.
 - For lock options, refer to Lock Program section of the Accessories Price List.
 - Spacer Options:
 - Floating Spacer (F); requires trim color (finished top).
 - Solid Spacer with plastic edge (L); requires edge trim color (unfinished top).
 - No Spacer (U); no surface specification required (unfinished top).
 - No Spacer (N); no surface specification required (finished top).
 - Floating and solid spacers are 1.19”(30mm)H.
 - Case ships assembled; Spacers and Base/Legs require field installation.
- ### Specification Tips
- Finished Back is separately specified when storage unit back is exposed.
 - 2H storage unit requires a solid or floating spacer for a 29”(737mm)H Adaptable worksurface.
 - For panel mounted applications; separately specify appropriate attachment brackets for support and load purposes.
 - Storage Unit:
 - with solid spacer are not intended for use with a knife edge Adaptable worksurface due to dimensional differences.
 - without spacer with finished or unfinished top may be used in a slip-fit or nested Adaptable worksurface application.
 - without spacer are for use with edgeband Adaptable worksurface only; not intended for use with knife edge due to dimensional differences.
 - Counterweight is not needed in a storage unit with doors.
 - Side panel base option provides approximately 1.625”(41mm) additional interior storage capacity. Refer to Specification Guide for details.
 - Stack-on Storage:
 - may be used with 1H or 2H storage unit; storage unit and stack-on to be same width.
 - not for use with 3H storage unit.
 - Refer to Specification Guide for planning information.

To Order, Specify:

- Product number, including:
 - Base/Leg Options:**
 - E** Side Panel Base
 - L** Plinth Base/Plastic Edge (add **\$551.52** list)
 - P** Chamfer Leg (add **\$180.04** list)
 - Lock Options:**
 - L** Locking (add **\$234.12** list)
 - N** Non-locking
 - Spacer Options:**
 - F** Floating Spacer/finished top 18”(457mm)D (add **\$253.82** list)
24”(610mm)D (add **\$280.30** list)
 - L** Solid Spacer/Plastic Edge/unfinished top (add **\$353.11** list)
 - U** No Spacer/unfinished top
 - N** No Spacer/finished top
- Case laminate surface color.
- Base/Leg trim color.
 - Side Panel Base (E) - (No finish specification.)
 - Plinth Base (L) - Edge trim color.
 - Chamfer (P) - Trim color.
- Spacer trim color.
 - Floating Spacer (F) - Trim color.
 - Solid Spacer (L) - Edge trim color.
- Lock plug trim color, if applicable.
- Laminate case edge trim color.

Freestanding Storage – Storage Cabinet

Double Hinged Door

Nominal Depth	Actual Depth Proud	Actual Depth Inset	Nominal Width	Number	①②③	HPL A	B
1H							
14.8"(376mm)	16"(406mm)	16.93"(430mm)	29.88"(759mm)	BZSS-1830-LL1T	■ ■ ■	\$ 2091.24	\$ 2258.53
			35.88"(911mm)	BZSS-1836-LL1T	■ ■ ■	2176.57	2343.86
		22.93"(582mm)	29.88"(759mm)	BZSS-2430-LL1T	■ ■ ■	2166.42	2333.71
			35.88"(911mm)	BZSS-2436-LL1T	■ ■ ■	2251.75	2419.04
2H							
26.9"(683mm)	28"(711mm)	16.93"(430mm)	29.88"(759mm)	BZSS-1830-LL2T	■ ■ ■	\$2766.58	\$ 2933.87
			35.88"(911mm)	BZSS-1836-LL2T	■ ■ ■	2851.91	3019.20
		22.93"(582mm)	29.88"(759mm)	BZSS-2430-LL2T	■ ■ ■	2841.76	3009.05
			35.88"(911mm)	BZSS-2436-LL2T	■ ■ ■	2927.09	3094.38
3H							
38.9"(988mm)	40.1"(1019mm)	16.93"(430mm)	29.88"(759mm)	BZSS-1830-LL3T	■ ■ ■	\$3552.17	\$ 3719.46
			35.88"(911mm)	BZSS-1836-LL3T	■ ■ ■	3637.50	3804.79
		22.93"(582mm)	29.88"(759mm)	BZSS-2430-LL3T	■ ■ ■	3627.35	3794.64
			35.88"(911mm)	BZSS-2436-LL3T	■ ■ ■	3712.68	3879.97

*Unfinished Inset Back

Freestanding Storage - Storage Cabinet

Open

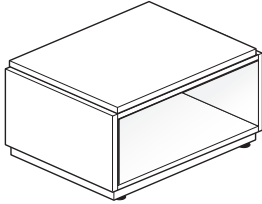

BZSN-LN1N

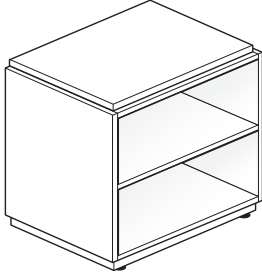

BZSN-LN2N

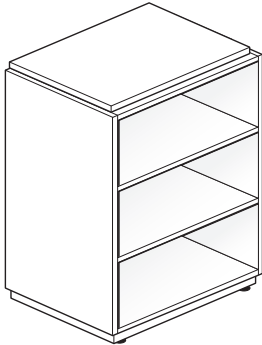

BZSN-LN3N
Class TA

Features

- Storage Units without doors include:
 - High-Pressure Laminate Case (HPL).
 - Standard with unfinished inset back.
 - Standard with finished interior.
 - Base or leg options.
 - Floating spacer option has a finished top.
 - Solid spacer option has an unfinished top.
- Shelves are 0.75" (19mm) thick and adjust 1.26" (32mm) up or down only.
 - 1H: open interior storage.
 - 2H: one adjustable shelf.
 - 3H: two adjustable shelves.
- Interior height dimension is based upon leg/base option chosen; refer to Specification Guide.
- Base/Leg Options:
 - Plinth Base with plastic edge (L); requires edge trim color.
 - Chamfer leg (P); requires trim color.
- Glide adjustment range:
 - Side Panel Base: 1" (25mm).
 - Plinth Base/Chamfer Leg: 1.25" (32mm).
- Spacer Options:
 - Floating Spacer (F); requires trim color (finished top).
 - Solid Spacer with plastic edge (L); requires edge trim color (unfinished top).
 - No Spacer (U); no surface specification required (unfinished top).
 - No Spacer (N); no surface specification required (finished top).
- Floating and solid spacers are 1.19" (30mm)H.
- Case ships assembled; Spacers and Plinth Base/Legs require field installation.

Specification Tips

- Finished Back is separately specified when storage unit back is exposed.
- 2H storage unit requires a solid or floating spacer for a 29" (737mm)H Adaptable worksurface.
- For panel mounted applications; separately specify appropriate attachment brackets for support and load purposes.
- Storage Unit without Doors:
 - with solid spacer is not intended for use with a knife edge Adaptable worksurface due to dimensional differences.
 - without spacer with finished or unfinished top may be used in a slip-fit or nested Adaptable worksurface application.
 - without spacer is for use with edgeband Adaptable worksurface only; not intended for use with knife edge due to dimensional differences.
- Counterweight is not needed in a storage unit.
- Side panel base option provides approximately 1.625" (41mm) additional interior storage capacity. Refer to Specification Guide for details.
- Stack-on Storage:
 - may be used with 1H or 2H storage unit; storage unit and stack-on to be same width.
 - may not be used with 3H storage unit.
- Refer to Specification Guide for planning information.

To Order, Specify:

1) Product number, including:

1 Base/Leg Options:

- E** Side Panel Base
- L** Plinth Base/Plastic Edge (add **\$551.52** list)
- P** Chamfer Leg (add **\$180.04** list)

2 Spacer Options:

- F** Floating Spacer/finished top 18" (457mm)D (add **\$253.82** list)
24" (610mm)D (add **\$280.30** list)
- L** Solid Spacer/Plastic Edge/unfinished top (add **\$353.11** list)
- U** No Spacer/unfinished top
- N** No Spacer/finished top

2) Case laminate surface color.

3) Base/Leg trim color.

Side Panel Base (E) - (No finish specification.)

Plinth Base (L) - Edge trim color.

Chamfer (P) - Trim color.

4) Spacer trim color.

Floating Spacer (F) - Trim color.

Solid Spacer (L) - Edge trim color.

5) Laminate case edge trim color.

Freestanding Storage - Storage Cabinet

Open

Nominal Depth	Actual Depth Proud	Actual Depth Inset	Nominal Width	Number	① ②		HPL	
							A	B
1H								
14.8"(376mm)	16"(406mm)	16"(406mm)	29.88"(759mm)	BZSN-1830-LN1N	■	N	\$ 1627.53	\$ 1757.78
			35.88"(911mm)	BZSN-1836-LN1N	■	N	1719.15	1849.40
		22"(559mm)	29.88"(759mm)	BZSN-2430-LN1N	■	N	1713.75	1844.00
			35.88"(911mm)	BZSN-2436-LN1N	■	N	1805.37	1935.62
2H								
26.9"(683mm)	28"(711mm)	16"(406mm)	29.88"(759mm)	BZSN-1830-LN2N	■	N	\$ 2343.34	\$ 2473.59
			35.88"(911mm)	BZSN-1836-LN2N	■	N	2434.96	2565.21
		22"(559mm)	29.88"(759mm)	BZSN-2430-LN2N	■	N	2429.56	2559.81
			35.88"(911mm)	BZSN-2436-LN2N	■	N	2521.18	2651.43
3H								
38.9"(988mm)	40.1"(1019mm)	16"(406mm)	29.88"(759mm)	BZSN-1830-LN3N	■	N	\$ 2978.15	\$ 3108.40
			35.88"(911mm)	BZSN-1836-LN3N	■	N	3069.77	3200.02
		22"(559mm)	29.88"(759mm)	BZSN-2430-LN3N	■	N	3064.37	3194.62
			35.88"(911mm)	BZSN-2436-LN3N	■	N	3155.99	3286.24

*Unfinished Inset Back

Freestanding Storage – Personal Storage Tower

Side Bookcase

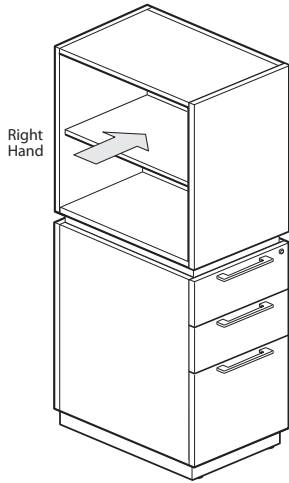

BZRH-LLR

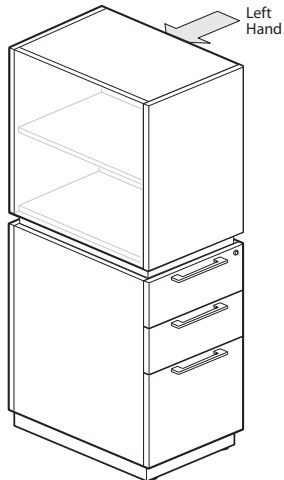

BZRH-LLL
Class TA

Features

- Freestanding Personal Storage Tower with Side Bookcase includes:
 - Base or leg and drawer pull options.
 - Bookcase with side access.
 - Black miterfold drawer interiors.
 - Bookcase interior/shelves are same finish specified on case.
 - High-Pressure Laminate (HPL) case with back with inset top, drawer fronts and bookcase interior.
- Bookcase includes:
 - 49”(1245mm)/57”(1448mm)H: one adjustable shelf.
 - 65”(1651mm)/73”(1854mm)H: two adjustable shelves.
 - Shelf adjustment: 1.26”(32mm) up or down only
- Box drawers include one black plastic divider each.
- One black plastic pencil tray included.
- File drawer includes integrated file hanging system and two file hangar bars per drawer for letter front-to-back filing.
- All drawers have full extension slides.
- Standard with single lock; lock plug available in chrome or black.
- For lock options refer to Lock Program section of the Accessories Price List.
- Drawer Pull Options:
 - Crescent (7), Linear (8) and Classic (9) pulls standard in Brushed Nickel finish (no specification required).
 - Integrated Aluminum J-Pull (K); aluminum finger pull requires trim color.
- Base/Leg Options:
 - Side Panel Base (E); sides/front extend to floor; side panels are part of case.
 - Plinth Base with plastic edge (L); requires edge trim color.
 - Chamfer leg (P); requires trim color.
- Glide height adjustment ranges:
 - Chamfer leg: 1.25”(32mm).
 - Side Panel Base/Plinth Base: 2”(51mm).
- Side bookcase orientation:
 - (R) right-hand side of unit
 - (L) left-hand side of unit
- Spacer Options:
 - Solid Spacer with plastic edge (L); requires edge trim color.
- Solid Spacers are 1.19”(30mm)H.
- Case ships assembled; Base/Legs require field installation.

Specification Tips

- Counterweight is not needed in a personal storage tower.
- Personal Storage Tower heights compliment Compose panel heights.
- Personal Storage Tower with Side Bookcase does not accommodate additional shelves.
- Refer to Specification Guide for planning information.

To Order, Specify:

1) Product number, including:

1 Pull Options:

- 7** Crescent
- 8** Linear
- 9** Classic
- K** Aluminum J-Pull

2 Base/Leg Options:

- E** Side Panel Base
- L** Plinth Base/Plastic Edge (add **\$326.42** list)
- P** Chamfer Leg (add **\$180.04** list)

3 Bookcase Orientation:

- R** Right hand bookcase
- L** Left hand bookcase

2) Case laminate surface color.

3) Base/Leg trim color.

Side Panel Base (E) - (No finish specification.)

Plinth Base (L) - Edge trim color.

Chamfer (P) - Trim color.

4) Spacer trim color.

5) Lock plug trim color.

6) Aluminum J-Pull trim color, if applicable.

7) Laminate case edge trim color.

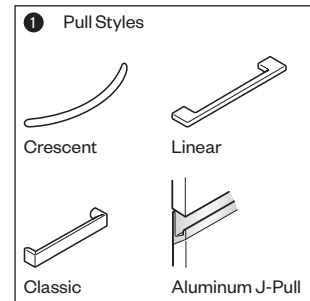

Freestanding Storage – Personal Storage Tower with Wardrobe Bookcase Upper Storage

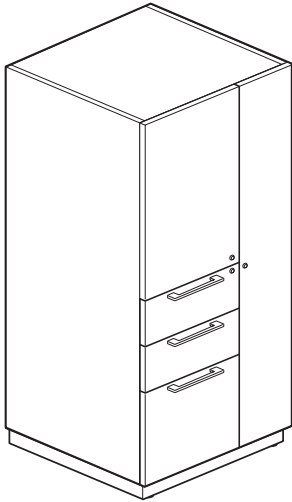

BZVH-LR

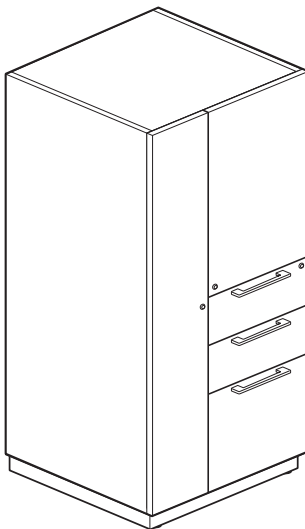

BZVH-LL

Note: Graphics shown with plinth base.
Class TA

Features

- Freestanding Personal Storage Tower with Wardrobe includes:
 - High-Pressure Laminate (HPL) case standard with unfinished inset back, inset top, drawer fronts and touch-latch doors.
 - Base or leg and drawer pull options.
 - Wardrobe and upper storage units with touch-latch doors.
 - Black miterfold drawer interiors.
 - Wardrobe/upper storage interiors/shelves are same finish specified on case.
- Storage unit includes:
 - 49"(1245mm)/57"(1448mm)H: one adjustable shelf.
 - 65"(1651mm)/73"(1854mm)H: two adjustable shelves.
 - Shelf adjustment: up or down only.
- Wardrobe includes:
 - 18"(457mm)D: stainless steel coat hook and one fixed shelf.
 - 24"(610mm)/30"(762mm)D: chrome coat rod and one fixed shelf.
- File drawer includes integrated file hanging system and two file hangar bars per drawer for letter front-to-back filing.
- All drawers have full extension slides.
- Drawer Pull Options:
 - Crescent (7), Linear (8) and Classic (9) pulls standard in Brushed Nickel finish (no specification required).
 - Integrated Aluminum J-Pull (K); aluminum finger pull requires trim color.
- Base/Leg Options:
 - Side Panel Base (E); sides/front extend to floor; side panels are part of case.
 - Plinth Base with plastic edge (L); requires edge trim color.
 - Chamfer leg (P); requires trim color.
- Glide adjustment range:
 - Side Panel Base: 1"(25mm).
 - Plinth Base/Chamfer Leg: 1.25"(32mm).
- Locking Option:
 - Drawers standard with single lock.
 - Lock plugs available in chrome or black.
 - For Lock options refer to Lock Program section of the Accessories Price List.
- Wardrobe orientation:
 - (R) right-hand side of unit
 - (L) left-hand side of unit
- Case ships assembled; Base/Legs require field installation.

Specification Tips

- Finished back is separately specified when personal storage tower with wardrobe back is exposed.
- Counterweight is not needed in a personal storage tower.
- Side panel base option provides approximately 1.625"(41mm) additional interior storage capacity on wardrobe side. Refer to Specification Guide for details.
- Personal Storage Tower with Wardrobe does not accommodate additional shelves.
- Refer to Specification Guide for planning information.

To Order, Specify:

1) Product number, including:

1 Pull Options:

- 7** Crescent
- 8** Linear
- 9** Classic
- K** Aluminum J-Pull

2 Base/Leg Options:

- E** Side Panel Base
- L** Plinth Base/Plastic Edge (add **\$408.27** list)
- P** Chamfer Leg (add **\$180.04** list)

3 Lock Options:

- L** Locking (add **\$481.72** list)
- N** Non-locking

4 Wardrobe Orientation:

- R** Right hand wardrobe
- L** Left hand wardrobe

2) Case laminate surface color.

3) Base/Leg trim color.
Side Panel Base (E) - (No finish specification.)
Plinth Base (L) - Edge trim color.
Chamfer (P) - Trim color.

4) Lock plug trim color.

5) Aluminum J-Pull trim color.

6) Laminate case edge trim color.

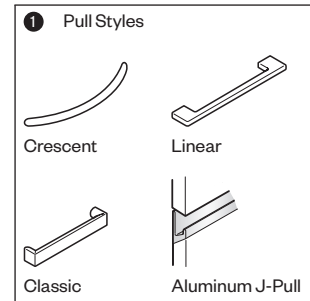

Freestanding Storage – Personal Storage Tower with Wardrobe Bookcase Upper Storage

Actual Height	Actual Depth	Actual Width	Description	Pull	Number	① ② ③ ④	HPL	
							A	B
49"(1245mm)	16.9"(429mm)	23.88"(607mm)	Box/Box/File	7,8,9	BZVH-4918-LLB	■ ■ ■ ■ N	\$4634.93	\$4986.10
				K	BZVH-4918-LLBK	■ ■ ■ ■ N	5065.28	5416.45
57"(1448mm)	16.9"(429mm)	23.88"(607mm)	Box/Box/File	7,8,9	BZVH-5718-LLB	■ ■ ■ ■ N	\$4802.85	\$ 5167.50
				K	BZVH-5718-LLBK	■ ■ ■ ■ N	5233.20	5597.85
65"(1651mm)	16.9"(429mm)	23.88"(607mm)	Box/Box/File	7,8,9	BZVH-6518-LLB	■ ■ ■ ■ N	\$4970.77	\$5348.90
				K	BZVH-6518-LLBK	■ ■ ■ ■ N	5401.12	5779.25
73"(1854mm)	16.9"(429mm)	23.88"(607mm)	Box/Box/File	7,8,9	BZVH-7318-LLB	■ ■ ■ ■ N	\$ 5138.69	\$5530.30
				K	BZVH-7318-LLBK	■ ■ ■ ■ N	5569.04	5960.65
49"(1245mm)	16.9"(429mm)	23.88"(607mm)	File/File	7,8,9	BZVJ-4918-LLB	■ ■ ■ ■ N	\$4529.11	\$ 4871.27
				K	BZVJ-4918-LLBK	■ ■ ■ ■ N	4959.46	5301.62
57"(1448mm)	16.9"(429mm)	23.88"(607mm)	File/File	7,8,9	BZVJ-5718-LLB	■ ■ ■ ■ N	\$ 4697.03	\$5052.67
				K	BZVJ-5718-LLBK	■ ■ ■ ■ N	5127.38	5483.02
65"(1651mm)	16.9"(429mm)	23.88"(607mm)	File/File	7,8,9	BZVJ-6518-LLB	■ ■ ■ ■ N	\$4864.95	\$5234.07
				K	BZVJ-6518-LLBK	■ ■ ■ ■ N	5295.30	5664.42
73"(1854mm)	16.9"(429mm)	23.88"(607mm)	File/File	7,8,9	BZVJ-7318-LLB	■ ■ ■ ■ N	\$5032.87	\$ 5415.47
				K	BZVJ-7318-LLBK	■ ■ ■ ■ N	5463.22	5845.82
49"(1245mm)	22.9"(582mm)	23.88"(607mm)	Box/Box/File	7,8,9	BZVH-4924-LLB	■ ■ ■ ■ N	\$ 4731.02	\$5089.85
				K	BZVH-4924-LLBK	■ ■ ■ ■ N	5161.37	5520.20
57"(1448mm)	22.9"(582mm)	23.88"(607mm)	Box/Box/File	7,8,9	BZVH-5724-LLB	■ ■ ■ ■ N	\$4898.94	\$ 5271.25
				K	BZVH-5724-LLBK	■ ■ ■ ■ N	5329.29	5701.60
65"(1651mm)	22.9"(582mm)	23.88"(607mm)	Box/Box/File	7,8,9	BZVH-6524-LLB	■ ■ ■ ■ N	\$5066.86	\$5452.65
				K	BZVH-6524-LLBK	■ ■ ■ ■ N	5497.21	5883.00
73"(1854mm)	22.9"(582mm)	23.88"(607mm)	Box/Box/File	7,8,9	BZVH-7324-LLB	■ ■ ■ ■ N	\$5234.78	\$5634.05
				K	BZVH-7324-LLBK	■ ■ ■ ■ N	5665.13	6064.40
49"(1245mm)	22.9"(582mm)	23.88"(607mm)	File/File	7,8,9	BZVJ-4924-LLB	■ ■ ■ ■ N	\$4625.20	\$ 4975.02
				K	BZVJ-4924-LLBK	■ ■ ■ ■ N	5055.55	5405.37
57"(1448mm)	22.9"(582mm)	23.88"(607mm)	File/File	7,8,9	BZVJ-5724-LLB	■ ■ ■ ■ N	\$ 4793.12	\$ 5156.42
				K	BZVJ-5724-LLBK	■ ■ ■ ■ N	5223.47	5586.77
65"(1651mm)	22.9"(582mm)	23.88"(607mm)	File/File	7,8,9	BZVJ-6524-LLB	■ ■ ■ ■ N	\$ 4961.04	\$ 5337.82
				K	BZVJ-6524-LLBK	■ ■ ■ ■ N	5391.39	5768.17
73"(1854mm)	22.9"(582mm)	23.88"(607mm)	File/File	7,8,9	BZVJ-7324-LLB	■ ■ ■ ■ N	\$ 5128.96	\$ 5519.22
				K	BZVJ-7324-LLBK	■ ■ ■ ■ N	5559.31	5949.57
49"(1245mm)	28.9"(734mm)	23.88"(607mm)	Box/Box/File	7,8,9	BZVH-4930-LLB	■ ■ ■ ■ N	\$ 4827.11	\$ 5193.60
				K	BZVH-4930-LLBK	■ ■ ■ ■ N	5257.46	5623.95
57"(1448mm)	28.9"(734mm)	23.88"(607mm)	Box/Box/File	7,8,9	BZVH-5730-LLB	■ ■ ■ ■ N	\$4995.03	\$ 5375.00
				K	BZVH-5730-LLBK	■ ■ ■ ■ N	5425.38	5805.35
65"(1651mm)	28.9"(734mm)	23.88"(607mm)	Box/Box/File	7,8,9	BZVH-6530-LLB	■ ■ ■ ■ N	\$ 5162.95	\$5556.40
				K	BZVH-6530-LLBK	■ ■ ■ ■ N	5593.30	5986.75
73"(1854mm)	28.9"(734mm)	23.88"(607mm)	Box/Box/File	7,8,9	BZVH-7330-LLB	■ ■ ■ ■ N	\$5330.87	\$ 5737.80
				K	BZVH-7330-LLBK	■ ■ ■ ■ N	5761.22	6168.15
49"(1245mm)	28.9"(734mm)	23.88"(607mm)	File/File	7,8,9	BZVJ-4930-LLB	■ ■ ■ ■ N	\$ 4721.29	\$ 5078.77
				K	BZVJ-4930-LLBK	■ ■ ■ ■ N	5151.64	5509.12
57"(1448mm)	28.9"(734mm)	23.88"(607mm)	File/File	7,8,9	BZVJ-5730-LLB	■ ■ ■ ■ N	\$4889.21	\$5260.17
				K	BZVJ-5730-LLBK	■ ■ ■ ■ N	5319.56	5690.52
65"(1651mm)	28.9"(734mm)	23.88"(607mm)	File/File	7,8,9	BZVJ-6530-LLB	■ ■ ■ ■ N	\$ 5057.13	\$ 5441.57
				K	BZVJ-6530-LLBK	■ ■ ■ ■ N	5487.48	5871.92
73"(1854mm)	28.9"(734mm)	23.88"(607mm)	File/File	7,8,9	BZVJ-7330-LLB	■ ■ ■ ■ N	\$ 5225.05	\$ 5622.97
				K	BZVJ-7330-LLBK	■ ■ ■ ■ N	5655.40	6053.32

Freestanding Storage – Wardrobe

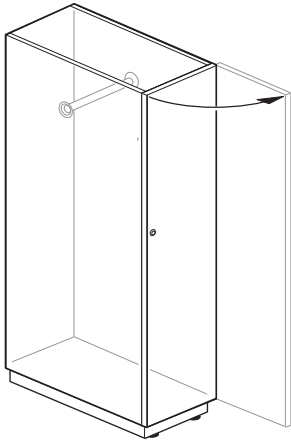

BZWK-LLR

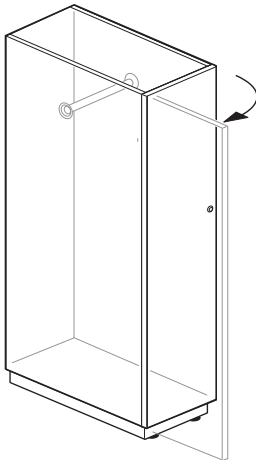

BZWK-LLL

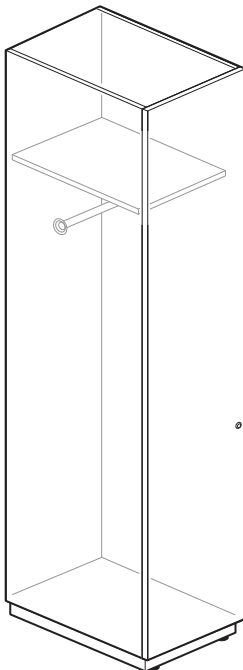

BZWK-LLL

Note: Graphics shown with plinth base.
Class TA

Features

- Wardrobe includes:
 - High-Pressure Laminate (HPL) case standard with unfinished inset back, inset top and touch-latch door.
 - Base or leg options.
 - 18"(457mm)D include coat hook.
 - 24"(610mm)/30"(762mm)D include coat rod.
- 73"(1854mm)H includes coat rod and one fixed shelf.
- Wardrobe interiors/shelves are same finish specified on case.
- Base/Leg Options:
 - Side Panel Base (E); sides/front extend to floor; side panels are part of case.
 - Plinth Base with plastic edge (L); requires edge trim color.
 - Chamfer leg (P); requires trim color.
- Glide adjustment range:
 - Side Panel Base: 1"(25mm).
 - Plinth Base/Chamfer Leg: 1.25"(32mm).
- Locking Option:
 - Lock plug available in chrome or black.
 - For lock options, refer to Lock Program section of the Accessories Price List.
- Door Swing Orientation:
 - (R) right-hand
 - (L) left-hand
- Case ships assembled; Base/Legs require field installation.

Specification Tips

- Finished back is separately specified when wardrobe back is exposed.
- Counterweight is not needed in a wardrobe.
- 12"(305mm)W wardrobes must be attached to panel or adjacent worksurface or another storage unit.
- Side panel base option provides approximately 1.625"(41mm) additional interior storage capacity. Refer to Specification Guide for details.
- Wardrobe door swing orientation is not field changeable.
- Refer to Specification Guide for planning information.

To Order, Specify:

1) Product number, including:

1 Base/Leg Options:

- E** Side Panel Base
- L** Plinth Base/Plastic Edge (add **\$408.27** list)
- P** Chamfer Leg (add **\$180.04** list)

2 Lock Options:

- L** Locking (add **\$240.86** list)
- N** Non-locking

3 Door Swing Orientation:

- R** Right hand swing
- L** Left hand swing

2) Case laminate surface color.

3) Base/Leg trim color.

Side Panel Base (E) - (No finish specification.)

Plinth Base (L) - Edge trim color.

Chamfer (P) - Trim color.

4) Lock plug trim color, if applicable.

5) Laminate case edge trim color.

Freestanding Storage – Wardrobe

Actual Height	Actual Depth	Actual Width	Number	① ② ③	HPL	
					A	B
49"(1245mm)	16.9"(429mm)	11.88"(302mm)	BZWK-4918-LLNT	■ ■ ■ N ■	\$2458.15	\$2653.98
57"(1448mm)			BZWK-5718-LLNT	■ ■ ■ N ■	2626.07	2835.38
65"(1651mm)			BZWK-6518-LLNT	■ ■ ■ N ■	2793.99	3016.78
73"(1854mm)			BZWK-7318-LLNT	■ ■ ■ N ■	2961.91	3198.18
49"(1245mm)	22.9"(582mm)	11.88"(302mm)	BZWK-4924-LLNT	■ ■ ■ N ■	\$2554.24	\$ 2757.73
57"(1448mm)			BZWK-5724-LLNT	■ ■ ■ N ■	2722.16	2939.13
65"(1651mm)			BZWK-6524-LLNT	■ ■ ■ N ■	2890.08	3120.53
73"(1854mm)			BZWK-7324-LLNT	■ ■ ■ N ■	3058.00	3301.93
49"(1245mm)	28.9"(734mm)	11.88"(302mm)	BZWK-4930-LLNT	■ ■ ■ N ■	\$2650.33	\$ 2861.48
57"(1448mm)			BZWK-5730-LLNT	■ ■ ■ N ■	2818.25	3042.88
65"(1651mm)			BZWK-6530-LLNT	■ ■ ■ N ■	2986.17	3224.28
73"(1854mm)			BZWK-7330-LLNT	■ ■ ■ N ■	3154.09	3405.68
49"(1245mm)	16.9"(429mm)	17.88"(454mm)	BZWF-4918-LLNT	■ ■ ■ N ■	\$ 2757.53	\$ 2978.12
57"(1448mm)			BZWF-5718-LLNT	■ ■ ■ N ■	2925.45	3159.52
65"(1651mm)			BZWF-6518-LLNT	■ ■ ■ N ■	3093.37	3340.92
73"(1854mm)			BZWF-7318-LLNT	■ ■ ■ N ■	3261.29	3522.32
49"(1245mm)	22.9"(582mm)	17.88"(454mm)	BZWF-4924-LLNT	■ ■ ■ N ■	\$2853.62	\$ 3081.87
57"(1448mm)			BZWF-5724-LLNT	■ ■ ■ N ■	3021.54	3263.27
65"(1651mm)			BZWF-6524-LLNT	■ ■ ■ N ■	3189.46	3444.67
73"(1854mm)			BZWF-7324-LLNT	■ ■ ■ N ■	3357.38	3626.07
49"(1245mm)	28.9"(734mm)	17.88"(454mm)	BZWF-4930-LLNT	■ ■ ■ N ■	\$2949.71	\$ 3185.62
57"(1448mm)			BZWF-5730-LLNT	■ ■ ■ N ■	3117.63	3367.02
65"(1651mm)			BZWF-6530-LLNT	■ ■ ■ N ■	3285.55	3548.42
73"(1854mm)			BZWF-7330-LLNT	■ ■ ■ N ■	3453.47	3729.82

Upper Storage – Stack-On Storage

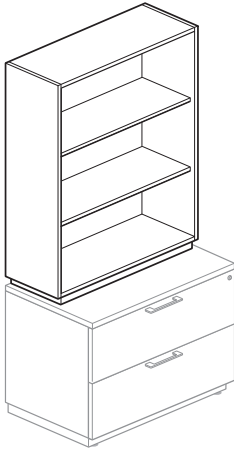

BZDL-LNNSNN

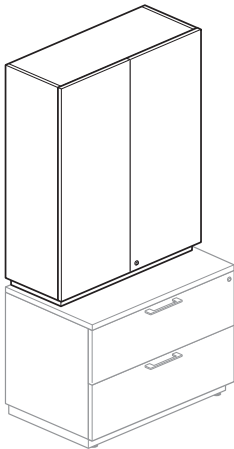

BZKL-LLFTSLN

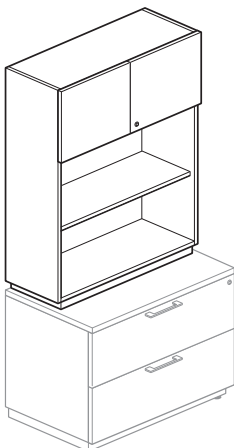

BZKL-LLPTSLN
Class TA

Features

- Stack-on Storage includes:
 - High-Pressure Laminate (HPL) case standard with unfinished inset back, inset top with shelf/shelves.
 - Base reveal/interiors/shelves are same finish specified on case.
 - Available with full touch-latch doors, partial touch-latch doors or no doors.
- Shelves adjust in increments of 1.26”(32mm) up or down only.
- Door height options:
 - Full height: Full height doors.
 - Partial Height: Doors on top only.
 - No Doors: Open unit.
- Locking Option:
 - Touch-latch doors available with or without locks.
 - Lock plugs available in chrome or black.
 - For lock options, refer to Lock Program section of the Accessories Price List.
- Case shipped assembled.

Specification Tips

- Finished back is separately specified when stack-on storage back is exposed.
- For use with 1H or 2H storage unit with spacer and an Adaptable Worksurface or a Compose storage top.
- Lower storage unit does not require a counterweight when used with a Stack-on.
- A Stack-on unit attached to a lower storage unit with spacer and Adaptable Worksurface or Compose storage top will compliment Compose panel heights.
- A Stack-on unit attached to a lower storage unit without spacer with a Compose storage top may be positioned in a freestanding application; height will not align with Compose panel heights.
- Not recommended for use directly on top of a storage unit without spacer.
- Width of Stack-on unit and lower storage unit must be the same.

To Order, Specify:

1) Product number, including:

1 Locking Option (Doors)

L Locking (add **\$240.86** list)

N None

2) Case laminate surface color.

3) Lock plug trim color, if applicable.

4) Laminate case edge trim color.

Upper Storage – Stack-On Storage

Actual Height	Actual Depth	Actual Width	Number	HPL	
				A	B
Without Doors					
19"(483mm)	13.3"(338mm)	29.88"(759mm)	BZDL-1930-LNNNSNN	\$ 1758.03	\$ 1884.09
		35.88"(911mm)	BZDL-1936-LNNNSNN	1785.04	1911.10
27"(686mm)		29.88"(759mm)	BZDL-2730-LNNNSNN	\$ 2014.63	\$ 2140.69
		35.88"(911mm)	BZDL-2736-LNNNSNN	2041.64	2167.70
31"(787mm)		29.88"(759mm)	BZDL-3130-LNNNSNN	\$ 2142.93	\$ 2268.99
		35.88"(911mm)	BZDL-3136-LNNNSNN	2169.94	2296.00
35"(889mm)		29.88"(759mm)	BZDL-3530-LNNNSNN	\$ 2271.23	\$ 2397.29
		35.88"(911mm)	BZDL-3536-LNNNSNN	2298.24	2424.30
39"(991mm)		29.88"(759mm)	BZDL-3930-LNNNSNN	\$ 2399.53	\$ 2525.59
		35.88"(911mm)	BZDL-3936-LNNNSNN	2426.54	2552.60
43"(1092mm)		29.88"(759mm)	BZDL-4330-LNNNSNN	\$ 2527.83	\$ 2653.89
		35.88"(911mm)	BZDL-4336-LNNNSNN	2554.84	2680.90
47"(1194mm)		29.88"(759mm)	BZDL-4730-LNNNSNN	\$ 2656.13	\$ 2782.19
		35.88"(911mm)	BZDL-4736-LNNNSNN	2683.14	2809.20
55"(1397mm)		29.88"(759mm)	BZDL-5530-LNNNSNN	\$ 2912.73	\$ 3038.79
		35.88"(911mm)	BZDL-5536-LNNNSNN	2939.74	3065.80

Actual Height	Actual Depth	Actual Width	Number	①	HPL	
					A	B
Full Height Doors						
19"(483mm)	14.3"(363mm)	29.88"(759mm)	BZKL-1930-LLFTS	N	\$ 2390.54	\$ 2516.60
		35.88"(911mm)	BZKL-1936-LLFTS	N	2460.33	2586.39
27"(686mm)		29.88"(759mm)	BZKL-2730-LLFTS	N	\$ 2764.22	\$ 2890.28
		35.88"(911mm)	BZKL-2736-LLFTS	N	2834.01	2960.07
31"(787mm)		29.88"(759mm)	BZKL-3130-LLFTS	N	\$ 2951.06	\$ 3077.12
		35.88"(911mm)	BZKL-3136-LLFTS	N	3020.85	3146.91
35"(889mm)		29.88"(759mm)	BZKL-3530-LLFTS	N	\$ 3137.90	\$ 3263.96
		35.88"(911mm)	BZKL-3536-LLFTS	N	3207.69	3333.75
39"(991mm)		29.88"(759mm)	BZKL-3930-LLFTS	N	\$ 3324.74	\$ 3450.80
		35.88"(911mm)	BZKL-3936-LLFTS	N	3394.53	3520.59
43"(1092mm)		29.88"(759mm)	BZKL-4330-LLFTS	N	\$ 3511.58	\$ 3637.64
		35.88"(911mm)	BZKL-4336-LLFTS	N	3581.37	3707.43
47"(1194mm)		29.88"(759mm)	BZKL-4730-LLFTS	N	\$ 3698.42	\$ 3824.48
		35.88"(911mm)	BZKL-4736-LLFTS	N	3768.21	3894.27
55"(1397mm)		29.88"(759mm)	BZKL-5530-LLFTS	N	\$ 4072.10	\$ 4198.16
		35.88"(911mm)	BZKL-5536-LLFTS	N	4141.89	4267.95
Partial Doors on Top						
35"(889mm)	14.3"(363mm)	29.88"(759mm)	BZKL-3530-LLPTS	N	\$ 3011.89	\$ 3137.95
		35.88"(911mm)	BZKL-3536-LLPTS	N	3070.42	3196.48
43"(1092mm)		29.88"(759mm)	BZKL-4330-LLPTS	N	\$ 3264.01	\$ 3390.07
		35.88"(911mm)	BZKL-4336-LLPTS	N	3322.54	3448.60
47"(1194mm)		29.88"(759mm)	BZKL-4730-LLPTS	N	\$ 3390.07	\$ 3516.13
		35.88"(911mm)	BZKL-4736-LLPTS	N	3448.60	3574.66
55"(1397mm)		29.88"(759mm)	BZKL-5530-LLPTS	N	\$ 3642.19	\$ 3768.25
		35.88"(911mm)	BZKL-5536-LLPTS	N	3700.72	3826.78

Finished Back

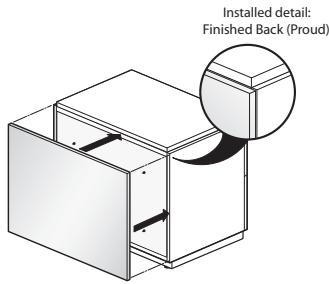

BZAB
Class TA

Features

- Includes 0.75"(19mm) thick High-Pressure Laminate (HPL) finished back and attachment hardware for use with Compose storage units:
 - pedestals, files; lateral or open, combination, storage units, personal storage towers with wardrobe, wardrobes and stack-on storage.
- For use with a single unit in a side-by-side application.
- Field installed.

Specification Tips

- Provides a finished back panel in an exposed storage back application.
- Provides a finished back in a storage supported convergent worksurface application.
- Finished Back adds 0.75"(19mm) to depth of the unfinished inset back storage unit.
- Refer to Specification Guide for planning information.

To Order, Specify:

1) Product number, including:

1 Unit Base Type:

E Side Panel Base

M Legs/Plinth Base

2) Laminate surface color.

3) Laminate back edge trim color.

Nominal Height	Nominal Width	Number ①	HPL	
			A	B
1H				
14"(356mm)	15.5"(394mm)	BZAB-0116-LS	\$ 281.51	\$304.07
	30"(762mm)	BZAB-0130-LS	305.23	329.61
	36"(914mm)	BZAB-0136-LS	315.39	340.55
1.5H				
20"(508mm)	15.5"(394mm)	BZAB-0016-LS	\$293.13	\$ 316.58
	30"(762mm)	BZAB-0030-LS	327.01	353.06
	36"(914mm)	BZAB-0036-LS	341.53	368.70
2H				
26"(660mm)	15.5"(394mm)	BZAB-0216-LS	\$304.74	\$329.09
	30"(762mm)	BZAB-0230-LS	348.79	376.52
	36"(914mm)	BZAB-0236-LS	367.66	396.84
3H				
38"(965mm)	30"(762mm)	BZAB-0330-LS	\$392.35	\$423.42
	36"(914mm)	BZAB-0336-LS	419.93	453.13
Personal Storage Tower with Wardrobe				
49"(1245mm)	24"(610mm)	BZAB-4924-LS	\$396.70	\$428.12
57"(1448mm)		BZAB-5724-LS	419.93	453.13
65"(1651mm)		BZAB-6524-LS	443.17	478.15
73"(1854mm)		BZAB-7324-LS	466.40	503.17
Stack-On Storage				
19"(483mm)	30"(762mm)	BZAB-1930-LS	\$323.38	\$349.15
	36"(914mm)	BZAB-1936-LS	337.17	364.01
27"(686mm)	30"(762mm)	BZAB-2730-LS	\$352.42	\$380.43
	36"(914mm)	BZAB-2736-LS	372.02	401.53
31"(787mm)	30"(762mm)	BZAB-3130-LS	\$366.94	\$396.06
	36"(914mm)	BZAB-3136-LS	389.44	420.30
35"(889mm)	30"(762mm)	BZAB-3530-LS	\$ 381.46	\$ 411.70
	36"(914mm)	BZAB-3536-LS	406.87	439.06
39"(991mm)	30"(762mm)	BZAB-3930-LS	\$395.98	\$ 427.33
	36"(914mm)	BZAB-3936-LS	424.29	457.82
43"(1092mm)	30"(762mm)	BZAB-4330-LS	\$ 410.50	\$442.97
	36"(914mm)	BZAB-4336-LS	441.71	476.59
47"(1194mm)	30"(762mm)	BZAB-4730-LS	\$425.02	\$458.61
	36"(914mm)	BZAB-4736-LS	459.14	495.35
55"(1397mm)	30"(762mm)	BZAB-5530-LS	\$454.06	\$489.88
	36"(914mm)	BZAB-5536-LS	493.99	532.88
Wardrobes				
49"(1245mm)	12"(305mm)	BZAB-4912-LS	\$325.55	\$ 351.50
	18"(457mm)	BZAB-4918-LS	361.13	389.81
57"(1448mm)	12"(305mm)	BZAB-5712-LS	\$ 337.17	\$364.01
	18"(457mm)	BZAB-5718-LS	378.55	408.57
65"(1651mm)	12"(305mm)	BZAB-6512-LS	\$348.79	\$376.52
	18"(457mm)	BZAB-6518-LS	395.98	427.33
73"(1854mm)	12"(305mm)	BZAB-7312-LS	\$360.40	\$389.03
	18"(457mm)	BZAB-7318-LS	413.40	446.10

Worksurface Support End

1H Worksurface Support End

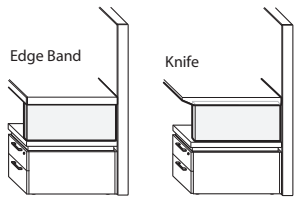
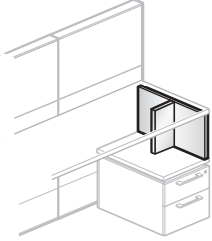

BZHU
Class TA

Features

- Includes finished T-shaped support end panel and attachment hardware.
 - High-Pressure Laminate (HPL) surfaces with plastic edgeband trim.
- Edge Options must match panel mounted worksurface edge.
- Provides worksurface end support; used with 1H storage.
- Non-handed design.

Specification Tips

- 1H lower storage unit
 - Must have a separately specified Compose Storage top; attaches to lower storage unit at bench height.
 - May have finished or unfinished top or a spacer.
- 1H worksurface support end does not attach into Compose panel slots.
- Refer to Specification Guide for planning information.

To Order, Specify:

1) Product number, including:

1 Edge Options:

- J** Edgeband
- F** Knife

2) Laminate surface color.

3) Edge trim color.

Nominal Height	Nominal Width	Number 1	HPL	
			A	B
11"(279mm)	18"(457mm)	BZHU-1811-LNF	\$428.96	\$462.62
	24"(610mm)	BZHU-2411-LNF	460.82	497.03
	30"(762mm)	BZHU-3011-LNF	492.68	531.44
	36"(914mm)	BZHU-3611-LNF	524.54	565.85
12"(305mm)	18"(457mm)	BZHU-1812-LNF	\$428.96	\$462.62
	24"(610mm)	BZHU-2412-LNF	460.82	497.03
	30"(762mm)	BZHU-3012-LNF	492.68	531.44
	36"(914mm)	BZHU-3612-LNF	524.54	565.85

Compose Storage Resources

Surfaces Materials

Index

Warranty/Terms of Sale

Surface Materials

Finish Color Legend

HPL

Grade A

Solid Color

H-34	Beige
H-AK	Chalk
H-8J	Charcoal
H-3J	Graphite
H-62	Gray Tone
H-WL	Linen
H-3P	Platinum
H-AA	Putty
H-3E	Smoke

Patterned

H-P1	Linen Casual
H-P2	Linen Classic
H-P3	Linen Crisp
H-P4	Linen Flax

Wood Grain

H-B06	Brazilwood
H-E79	Colombian Walnut
H-DYP	New Age Oak
H-AE	Maple
H-E15	River Cherry
H-C09	Williamsburg Cherry

Grade B

Premium Wood Grain

H-C8	Blonde Modern Cherry
H-D1	Daintree
H-KP	Field Elm
H-KN	Grey Elm
H-KM	Landmark Wood
H-D2	Mocha Modern Cherry
H-KL	Neo Walnut
H-KR	Phantom Ecoru
H-KS	Phantom Pearl
H-C9	Spiced Modern Cherry

Edgeband

Solid Color

HP-34	Beige
HP-AK	Chalk
HP-8J	Charcoal
HP-3J	Graphite
HP-62	Gray Tone
HP-WL	Linen
HP-3P	Platinum
HP-AA	Putty
HP-3E	Smoke

Patterned Edgeband

HP-P1	Linen Casual
HP-P2	Linen Classic
HP-P3	Linen Crisp
HP-P4	Linen Flax

Wood Grain

HP-C8	Blonde Modern Cherry
HP-B06	Brazilwood
HP-E79	Colombian Walnut
HP-D1	Daintree
HP-KP	Field Elm
HP-KN	Grey Elm
HP-KM	Landmark Wood
HP-AE	Maple
HP-D2	Mocha Modern Cherry
HP-KL	Neo Walnut
HP-DYP	New Age Oak
HP-KR	Phantom Ecoru
HP-KS	Phantom Pearl
HP-E15	River Cherry
HP-C9	Spiced Modern Cherry
HP-C09	Williamsburg Cherry

Ply-Edge

HP-PW	Ply-Edge
-------	----------

Trim

Grade A

Smooth

TR-R	Beige
TR-F	Black
TR-AK	Chalk
TR-K	Charcoal
TR-C1	Cocoa
TR-J	Graphite
TR-G	Gray Tone
TR-AA	Putty
TR-E	Smoke
TR-PLS	Smooth Plaster
TR-FM	Snow

Textured

TR-TG	Grout
TR-TF	Pitch
TR-TW	Plaster

Grade B

Smooth

TR-1C	Accent Blue
TR-1E	Accent Orange
TR-1G	Blue Jay
TR-1R	Brownstone
TR-1N	Night
TR-1Q	Park
TR-RR	Rusty Red
TR-1M	Sable
TR-1J	Sky Blue
TR-1K	Wren

Smooth Metallic

TR-BN	Bronze
TR-DM	Dark Bronze Metallic
TR-BG	Light Bronze
TR-MC	Metallic Champagne
TR-MG	Metallic Gunmetal
TR-LE	Metallic Silver

Textured Metallic

TR-AR	Argent
TR-HE	Hellenic

Lock Plugs

LR-BL	Black
LR-BP	Chrome

ALERT: These materials are current, however they are being considered for future obsolescence due to low volume.

HPL	
H-AM	Amber Cherry
H-AD	Medium Cherry

Edgeband	
HP-AM	Cherry
HP-AD	Medium Cherry

Trim	
TR-IF	Accent Red
TR-CTS	Chartreuse
TR-1H	Terra

Surface Materials

Fabrics/Color Legend

Seating Fabrics

Grade A

- (4H) Blanket
- (3J) Hobson
- (4J) Morse
- (3L) Novelty
- (2A) Pixel
- (3A) Tellure
- (XJ) Wellington Faux Leather

Grade B

- (4N) Diagonale
- (4Z) Element
- (4E) English Tweed
- (S6) Floyd by Kvadrat
- (S4) Kaleidoscope
- (SN) Pemberton
- (4V) Ramie
- (S8) Reflect by Kvadrat
- (MV) Tech

Grade C

- (6K) Dots
- (67) King II
- (68) Maya II
- (4T) Oceanic
- (3S) Scapes

Grade D

- (LW) Atlas by Kvadrat
- (4D) Big Arrow
- (1K) Big Diagonale
- (NV) Clara 2 by Kvadrat
- (66) Class II
- (JB) Cotswold
- (6M) Main Line Flax
- (S7) Melange Nap by Kvadrat
- (RP) Recheck by Kvadrat

Grade E

- (XG) Brisa Faux Leather
- (SY) Steelcut Trio 3 by Kvadrat

Grade F

- (SV) Divina Melange 3 by Kvadrat
- (SZ) Hallingdal 65 by Kvadrat

* For most current finish and fabric availability please reference surfaces.haworth.com.

ALERT: These materials are current, however they are being considered for future obsolescence due to low volume.

Fabrics

Grade A
(MM) Twist

Grade B
(1X) Gauge

Haworth+

For information on the Haworth+ alliance program, including images and product availability, please refer to: [Haworth.com](https://www.haworth.com) > Surface Collection > Haworth+ Library

Customer's Own Material (COM)

For general Customer's Own Material (COM) information including processes and forms, please refer to: [Haworth.com](https://www.haworth.com) > Surface Collection > Resources > COM

For information on approved COM's, please refer to: [Haworth.com](https://www.haworth.com) > Surface Collection > COM Library

Index

Products are listed alphabetically in this index by alpha-numeric prefix/suffix codes.

Product Code	Product Description	Page
BZAB	Finished Back	.37
BZAH	Modular Lower Storage – Lateral File and Storage Accessories – Lateral File Hanging Bar	.21
BZBG	Modular Lower Storage – Lateral File and Storage Accessories – Storage-to-Panel Bracket	.21
BZBG	Modular Lower Storage – Pedestal Accessories – Storage-to-Panel Bracket	.14
BZDL-LNNNSNN	Upper Storage – Stack-On Storage	.35
BZHU	Worksurface Support End – 1H Worksurface Support End	.38
BZKL-LLFTSLN	Upper Storage – Stack-On Storage	.35
BZKL-LLPTSLN	Upper Storage – Stack-On Storage	.35
BZL1	Modular Lower Storage – Lateral File	.15
BZL2	Modular Lower Storage – Lateral File	.15
BZL3	Modular Lower Storage – Lateral File	.15
BZLA	Modular Lower Storage – Lateral File	.15
BZLB	Modular Lower Storage – Combination Unit	.19
BZLC	Modular Lower Storage – Combination Unit	.19
BZLV	Modular Lower Storage – Lateral File with Open Shelf – Attached or Freestanding	.17
BZLZ	Modular Lower Storage – Lateral File with Open Shelf – Attached or Freestanding	.17
BZMA-CLN	Modular Lower Storage – Mobile Pedestals	.10
BZMA-GLN	Modular Lower Storage – Mobile Pedestals	.10
BZMH-CLN	Modular Lower Storage – Mobile Pedestals	.10
BZMH-GLN	Modular Lower Storage – Mobile Pedestals	.10
BZMJ-CLN	Modular Lower Storage – Mobile Pedestals	.10
BZMJ-GLN	Modular Lower Storage – Mobile Pedestals	.10
BZPA	Modular Lower Storage – Attached/Freestanding Pedestals	.12
BZPH	Modular Lower Storage – Attached/Freestanding Pedestals	.12
BZPJ	Modular Lower Storage – Attached/Freestanding Pedestals	.12
BZPX	Modular Lower Storage – Attached/Freestanding Pedestals	.12
BZRH-LLL	Freestanding Storage – Personal Storage Tower – Side Bookcase	.29
BZRH-LLR	Freestanding Storage – Personal Storage Tower – Side Bookcase	.29
BZSC-F	Modular Lower Storage – Lateral File and Storage Accessories – File/Storage Cushion	.21
BZSC-F	Modular Lower Storage – Pedestal Accessories – Pedestal Cushion	.14
BZSN-LN1N	Freestanding Storage - Storage Cabinet – Open	.27
BZSN-LN2N	Freestanding Storage - Storage Cabinet – Open	.27
BZSN-LN3N	Freestanding Storage - Storage Cabinet – Open	.27
BZSS-LL1T	Freestanding Storage – Storage Cabinet – Double Hinged Door	.25
BZSS-LL2T	Freestanding Storage – Storage Cabinet – Double Hinged Door	.25
BZSS-LL3T	Freestanding Storage – Storage Cabinet – Double Hinged Door	.25
BZTB-1862	Continuous Storage Tops	.23
BZTM-1836	Off-Modular Storage Tops	.24
BZTR-1830	Individual/Common Storage Tops	.22
BZTR-1860	Individual/Common Storage Tops	.22
BZTR-3660	Individual/Common Storage Tops	.22
BZVH-LL	Freestanding Storage – Personal Storage Tower with Wardrobe – Bookcase Upper Storage	.31
BZVH-LR	Freestanding Storage – Personal Storage Tower with Wardrobe – Bookcase Upper Storage	.31
BZWK-LLL	Freestanding Storage – Wardrobe	.33
BZWK-LLL	Freestanding Storage – Wardrobe	.33
BZWK-LLR	Freestanding Storage – Wardrobe	.33
JPTA-6	Modular Lower Storage – Pedestal Accessories – Pencil Tray	.14

Product Compatibility and Limited Warranty Policy

Great Expectations

You have them as a Haworth customer and so do we. And because we value our customers, we cover our products with the Haworth North America Product Compatibility and Limited Warranty Policy.

Our Commitment To Product Compatibility – Integrated Product Platforms

As a market leader in the design and manufacture of workspaces that adapt to change, we strive to maintain product compatibility within our various generations of integrated product platforms. This benefits the customer who desires to update or modify their work environment. It also benefits the customer needing to replace a product due to damage or other reasons but which is no longer manufactured or is otherwise unavailable, such as a fabric or finish that is discontinued because of changing market preferences. In both circumstances, we often can provide products with comparable function and performance.

Our Commitment To Product Quality – The Haworth North America Limited Warranty

To ensure customer satisfaction and peace of mind, we stand behind our products with the Haworth North America Limited Warranty. To review the current version of the limited warranty including its terms and conditions, please go to:

www.haworth.com/warranty or contact OneTouch@Haworth.com or 1 877 429 6784.

Warranty Requests or Questions

For questions or service requests pertaining to the Haworth Limited Warranty, please contact your Haworth dealer.

If you are unsure who your dealer is, please contact **OneTouch@Haworth.com or 1 877 429 6784.**

Terms of Sale

The Terms of Sale apply to all products in the North America Price Lists. To review the current version of the North American Terms of Sale, please go to:

www.haworth.com/terms-of-sale or contact OneTouch@Haworth.com or 1 877 429 6784.

HAWORTH

HAWORTH® is a registered trademark of Haworth, Inc.
© Haworth, Inc. All rights reserved. 2026 2.26
haworth.com | 800 344 2600