

Openest Collection

GSA Price List – February 2026



This price list is based upon Haworth's December 2025 commercial pricing.
GENERAL SERVICES ADMINISTRATION FEDERAL SUPPLY SERVICE
Authorized Federal Supply Scheduled Price List (Catalog) Office Furniture, Wood Casegoods and Tables
(FSC Group 71, Part I, FSC Classes 7105, 7110, 7125 and 7195)
Contract No: GS-03F-057DA | Contract Period: February 28, 2026 – February 7, 2031 | Business: Large
Contractor: Haworth, Inc. | One Haworth Center | Holland, MI 49423-9576 | 1.616.393.3000





This Haworth North American price book contains US list prices.

Canadian customers can convert the US list price into their Canadian equivalent by going to www.Haworth.com/Canada to find the current Canadian multipliers. These multiplier factors allow you to convert the US list price into a Canadian list price.

HAWORTH, INC.

GENERAL SERVICES ADMINISTRATION

FEDERAL ACQUISITION SERVICES

Authorized Federal Supply Schedule Furniture (FSC Group 71, FSC Classes 7105, 7110, 7125 and 7195)

Contract Number:	GS-03F-057DA
Contract Start Date:	February 28, 2026
Contract End Date:	February 7, 2031
Contractor:	HAWORTH, INC. One Haworth Center Holland, MI 49423-9576 1-616-393-3000 http://www.haworth.com/government
Business Size:	Large

Information for Ordering Activities I-FSS-600

Online access to Haworth's Authorized Federal Supply Schedule contract ordering information, terms and conditions, and up-to-date product and discount listing can be found at GSA Advantage, eLibrary link [here](#).



This Page Intentionally Left Blank

Openest Price List

Includes pricing, catalog numbers, finish codes/availability, specification requirements, line art, dimensions, and specification tips for Openest.

Plume Screens

Feather Sofa

Chick Pouf

Tables

Desks

Booths

Accessories

Power and Utility Modules

Table of Contents

Price List

Statement of Line	7-9
At-A-Glance	10
Plume Screens	
Plume 3	11
Plume 6	11
Plume 9	11
Feather Sofa	
Feather – Symmetrical	12
Feather – Asymmetrical	12
Chick Pouf	
Chick Pouf with Back	13
Chick Pouf without Back	13
Large Square - No Back	14
Rectangle - No Back	14
Round - No Back	15
Sprig Tables	
Rectangle	16
Round	16
Desk	
Single Desk	17
Double Desk	18
Privacy Desk	19
Booth	
Single Booth	20
Double Booth	21
Corner Booth	22
Privacy Booth	23
Conference Booth	24
Accessories	
Coat Hook	25
Soft Storage	25
Pillows	25
Hideaway Power Module	26
Bezel Utility Module	27
Resources	
Surface Materials	
Finish/Color Legend	29
Fabrics/Color Legend	30
Index	31
Lifetime Product Warranty	Inside Back Cover

Statement of Line

Plume Screens

Page 11

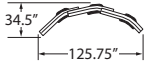
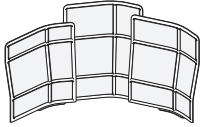

Plume 3

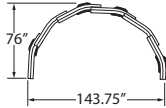
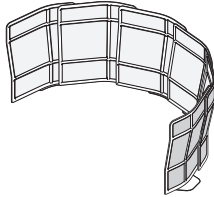

Plume 6

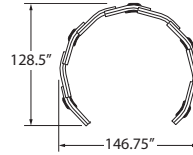
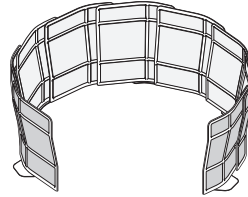

Plume 9

Feather Sofa — Symmetrical

Page 12

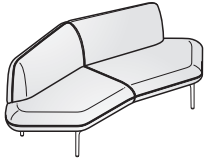

Symmetrical

Feather Sofa — Asymmetrical

Page 12

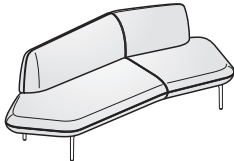

Asymmetrical - Right Hand

Statement of Line

Chick Pouf

Pages 13-15

Outer Surfaces Material Specified: • Always Match
Inner Surfaces Material Specified: • Always Match

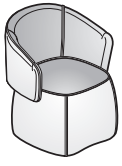

With Back

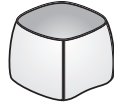
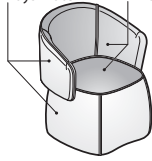

Without Back

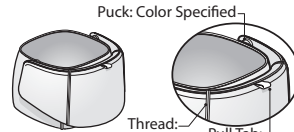

Pucker: Color Specified
Thread: Color Specified
Pull Tab: Color Not Specified, Orange Only

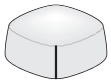

Large Square - No Back

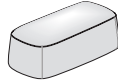

Rectangle - No Back

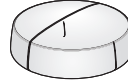

Round - No Back

Sprig Tables

Page 16

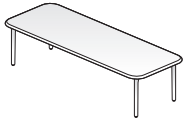

Rectangle



Round



Desks

Pages 17-19



Single Desk

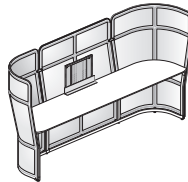

Double Desk

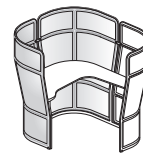

Privacy Desk

Booths

Pages 20-24



Single Booth

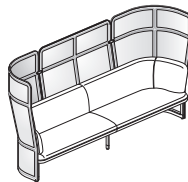

Double Booth

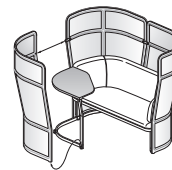

Corner Booth

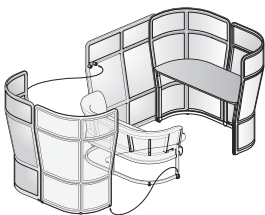

Privacy Booth

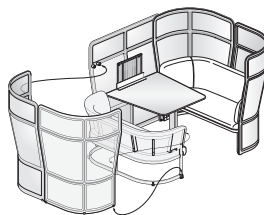

Conference Booth

Statement of Line

Accessories

Pages 26-28

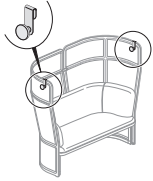

Coat Hook



Soft Storage

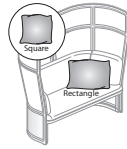

Pillows

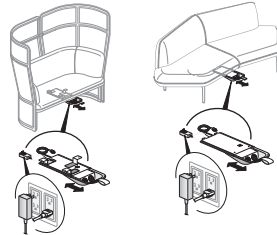

Hideaway Power Module

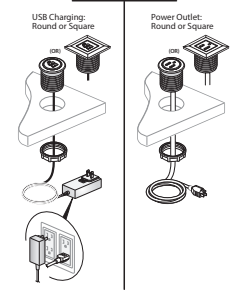

Bezel Utility Module

At-A-Glance

Designer

Patricia Urquiola - Studio Urquiola

Awards/ Achievements

NeoCon 2014 - Best of Competition - Collaborative Collections

NeoCon 2014 - Best of NeoCon Gold - Collaborative Collections

Plume Screen

- Available:
 - Plume 3 - (1) screen 57"H, (1) screen 65"H, (1) screen 61"H
 - Plume 6 - (6) screens all 57"H (shown)
 - Plume 9 - (9) screens all 57"H
- Screens always connect

Feather Sofa

- Available: Symmetrical or Asymmetrical (Left Handed Asymmetrical shown)
- Specifiable top stitch
- Fabric always applied railroad

Chick Pouf without Back

- Specifiable top stitch
- Fabric always applied railroad

Chick Pouf with Back

- Seat and Inside Back always match
- Base and Backrest always match
- Specifiable top stitch
- Fabric always applied railroad

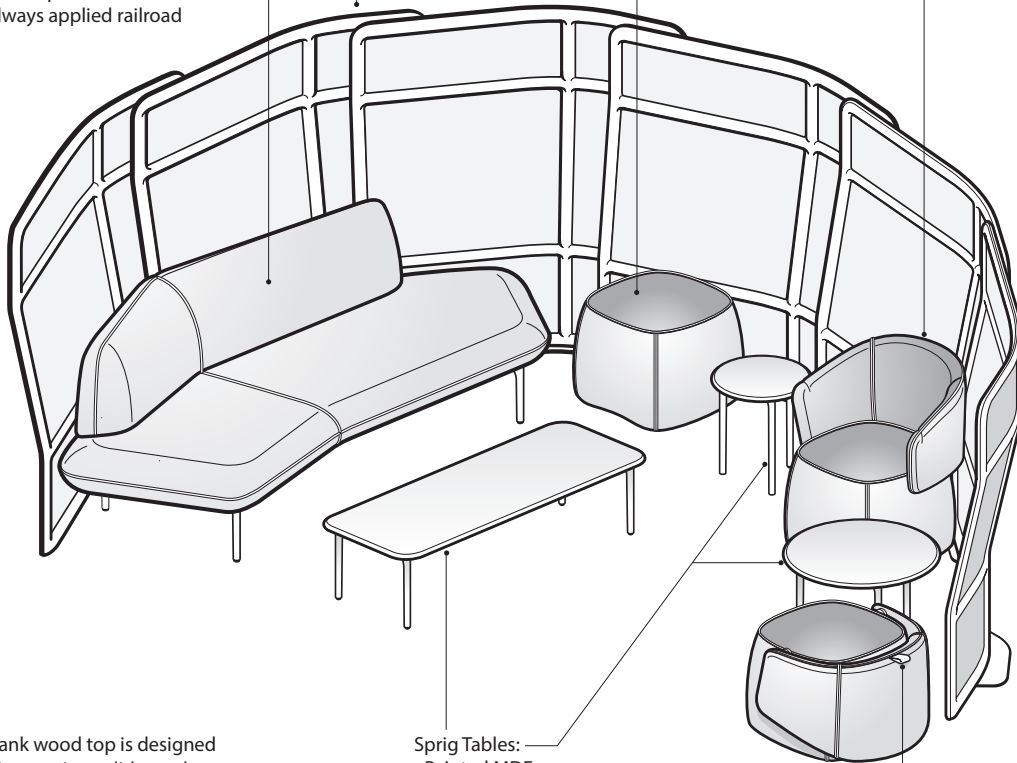

Note - Plank wood top is designed to be unique, using solid wood planks with a clear, low gloss finish allowing visibility of the natural beauty of each wood plank.

- Sprig Tables:
- Painted MDF
 - Plank White Oak
 - Plank Walnut
 - Leg color specified

- Pull Tab
- Color not specified, Orange only

Plume Screens

Plume 3

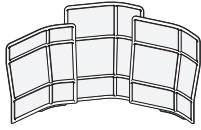

SON-3
Class QA

Features

- Includes:
 - (1) 57"(1448mm)H x 50"(1270mm)W screen,
 - (1) 65"(1651mm)H x 50"(1270mm)W screen,
 - (1) 61"(1549mm)H x 50"(1270mm)W screen.
- All screens are connected together, not interchangeable.
- Available in King II, Class II and Maya II fabrics only; COM not available.
- Floor support and screen connectors in same color.

Dimensions

H: 65"(1651mm) D: 34.5"(876mm) W: 125.75"(3194mm) (Outside)
113.5"(2883mm) (Inside)

To Order, Specify:

- Product number.
- Inner material.
- Outer Material.
- Trim color.

Number	Fabric	
	C	D
SON-3	\$14469.36	\$16695.40

Plume 6

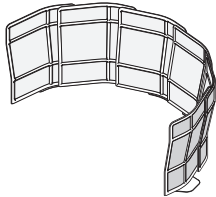

SON-6
Class QA

Features

- Includes:(6) 57"(1448mm)H x 50"(1270mm)W screens.
- All screens are connected together, not interchangeable.
- Available in King II, Class II and Maya II fabrics only; COM not available.
- Floor support and screen connectors in same color.

Dimensions

H: 57"(1448mm) D: 84"(2134mm) W: 143.75"(3651mm) (Outside)
132"(3353mm) (Inside)

To Order, Specify:

- Product number.
- Inner material.
- Outer Material.
- Trim color.

Number	Fabric	
	C	D
SON-6	\$27825.61	\$31535.71

Plume 9

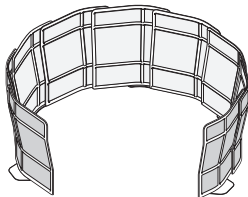

SON-9
Class QA

Features

- Includes:
 - (9) 57"(1448mm)H x 50"(1270mm)W screens.
- All screens are connected together, not interchangeable.
- Available in King II, Class II and Maya II fabrics only; COM not available.
- Floor support and screen connectors in same color.

Dimensions

H: 57"(1448mm) D: 128.5"(3264mm) W: 146.75"(3727mm) (Outside)
131.25"(3334mm) (Inside)

To Order, Specify:

- Product number.
- Inner material.
- Outer Material.
- Trim color.

Number	Fabric	
	C	D
SON-9	\$41738.50	\$46376.12

Note: For mixed grade fabric surfaces, please refer to the electronic design and specification tools for these prices.

Note: The Openest Plume screen is made with polyester fabric adhered to a polyester core. The screen is compliant with UL-1286 flammability requirements and California Technical Bulletin TB-117-2013 requirements. The fabric covering is compliant with NFPA 701 requirements. Consult your local code authority to assure that screens are compliant prior to installation.

Feather Sofa

Feather – Symmetrical

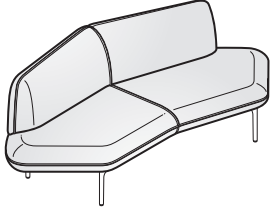

SOSS-1-N
Class QA

Features

- Includes: Sofa with specifiable top-stitch thread.
- Legs: Painted cast aluminum.
- COM yardage: 6.5

Specification Tips

- Fabric will be applied railroaded.
- Linear or patterned fabric is not recommended due to the manner in which fabric is applied.

Dimensions

Sofa

SH: 16.5"(419mm) SD: 25"(635mm) W: 87"(2210mm)
 TH: 30.25"(768mm) TD: 37"(940mm)

To Order, Specify:

1) Product number, including:

1 Surface Material:

- 1 Leather
- 2 Fabric
- 3 Faux Leather

2) Surface color.

3) Thread color.

4) Leg color.

Number ①	Fabric							Leather		
	A	B	C	D	E	F	G	A	B	
SOSS- -N	\$5565.13	\$5880.49	\$6232.94	\$6492.65	\$7049.17	\$7327.41	\$7930.30	\$8115.81	\$10991.12	\$13217.19

Feather – Asymmetrical

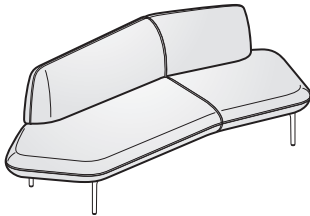

SOSR-1-N
Class QA

Features

- Includes: Sofa with specifiable top-stitch thread.
- Legs: Painted cast aluminum.
- COM yardage: 6.75

Specification Tips

- Fabric will be applied railroaded.
- Linear or patterned fabric is not recommended due to the manner in which fabric is applied.
- Handedness determined when seated on sofa.

Dimensions

Sofa

SH: 16.5"(419mm) SD: 25"(635mm) W: 92"(2337mm)
 TH: 30.25"(768mm) TD: 37"(940mm)

To Order, Specify:

1) Product number, including:

1 Handedness:

- R Right hand
- L Left hand

2 Surface Material:

- 1 Leather
- 2 Fabric
- 3 Faux Leather

2) Surface color.

3) Thread color.

4) Leg color.

Number ① ②	Fabric							Leather		
	A	B	C	D	E	F	G	A	B	
SOS - -N	\$5657.87	\$5991.79	\$6353.52	\$6724.51	\$7281.02	\$7605.68	\$8254.94	\$8394.08	\$11074.58	\$13356.30

The following options require modification of the product number.

Stain Repellent

To specify, add **OP** to the end of the product number (add **\$276.94** list); **Example: SOSR-2-NOP**

Chick Pouf

Chick Pouf with Back

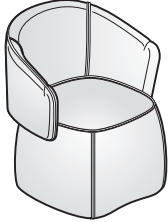

SOPB-2223
Class QA

Features

- Includes: Seat and back with specifiable top-stitch thread and puck colors.
- Seat back flips up and down.
- Pull tab to flip back up or down available in orange only.
- COM yardage:
 - Inner/Outer surfaces matching: 3.5
 - Inner Back and Seat only: 1.5
 - Outer Back and Base only: 2.0

Specification Tip

- Linear or patterned fabric is not recommended due to the manner in which fabric is applied.

Dimensions

SH: 18"(457mm) SD: 18.75"(476mm) W: 26"(660mm)
 TH: 37.75"(959mm) TD: 25.2"(640mm)

To Order, Specify:

- Product number, including:
 - Inner Surface Material:**
 - Leather
 - Fabric
 - Faux Leather
 - Outer Surface Material:**
 - Leather
 - Fabric
 - Faux Leather
- Inner Surface Color (Seat, inside back).
- Outer Surface Color (Base, outer back).
- Thread color.
- Puck color.

Number ①②	Fabric									Leather	
	A	B	C	D	E	F	G	H	A	B	
SOPB-23-00H	\$3246.28	\$3431.78	\$3682.26	\$3914.14	\$4285.12	\$4479.92	\$4915.78	\$5054.96	\$6121.66	\$7281.02	

Chick Pouf without Back

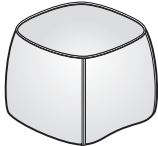

SOPN-2223
Class QA

Features

- Includes: Seat/Base only with specifiable top-stitch thread color.
- COM yardage:
 - Seat and Base matching: 2.75
 - Seat only: .75
 - Base only: 2.0

Specification Tip

- Linear or patterned fabric is not recommended due to the manner in which fabric is applied.

Dimensions

H: 18"(457mm) D: 22.5"(572mm) W: 23.25"(591mm)

To Order, Specify:

- Product number, including:
 - Seat Surface Material:**
 - Leather
 - Fabric
 - Faux Leather
 - Base Surface Material:**
 - Leather
 - Fabric
 - Faux Leather
- Inner Surface Color (Seat).
- Outer Surface Color (Base).
- Thread color.

Number ①②	Fabric									Leather	
	A	B	C	D	E	F	G	H	A	B	
SOPN-23-00H	\$1567.52	\$1669.49	\$1827.17	\$1994.16	\$2216.72	\$2344.74	\$2643.40	\$2717.60	\$3616.06	\$4495.35	

The following options require modification of the product number.

Stain Repellent

To specify, add **-P** to the end of the product number (add **\$139.39** list with Back or **\$79.67** without Back);

Example: SOPB-2223-00HP; SOPN-2223-00HP

Note: For mixed grade fabric surfaces, please refer to the electronic design and specification tools for these prices.

Chick Pouf

Large Square - No Back

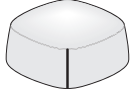

SOPN-2238
Class QA

Features

- Includes: Seat and base with specifiable top-stitch thread around the top and down the corners.
- Available with black hard or felt glides.
- COM yardage:
Seat and Base matching: 4.0
Seat only: 1.3
Base only: 2.6

Specification Tips

- Fabric will be applied railroaded.
- Linear or patterned fabric is not recommended due to the manner in which fabric is applied.

Dimensions

H: 17"(432mm) D: 37.75"(959mm) W: 37.75"(959mm)

To Order, Specify:

1) Product number, including:

1 Seat Surface Material:

- 1 Leather
- 2 Fabric
- 3 Faux Leather

2 Base Surface Material:

- 1 Leather
- 2 Fabric
- 3 Faux Leather

3 Glide Option:

- H Hard Glides
- K Felt Glides

2) Seat surface color.

3) Base surface color.

4) Thread color.

Number	Fabric							Leather				
	1 2	3	A	B	C	D	E	F	G	H	A	B
SOPN-38-00			\$2247.95	\$2397.82	\$2547.66	\$2703.80	\$2847.38	\$3521.80	\$3896.41	\$4570.83	\$4307.74	\$5032.06

Rectangle - No Back

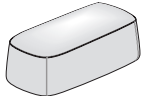

SOPN-2252
Class QA

Features

- Includes: Seat and base with specifiable top-stitch thread around the top and down the corners.
- Available with black hard or felt glides.
- COM yardage:
Seat and Base matching: 4.6
Seat only: 2.0
Base only: 2.6

Specification Tips

- Fabric will be applied railroaded.
- Linear or patterned fabric is not recommended due to the manner in which fabric is applied.

Dimensions

H: 18"(457mm) D: 27"(686mm) W: 52"(1321mm)

To Order, Specify:

1) Product number, including:

1 Seat Surface Material:

- 1 Leather
- 2 Fabric
- 3 Faux Leather

2 Base Surface Material:

- 1 Leather
- 2 Fabric
- 3 Faux Leather

3 Glide Option:

- H Hard Glides
- K Felt Glides

2) Seat surface color.

3) Base surface color.

4) Thread color.

Number	Fabric							Leather				
	1 2	3	A	B	C	D	E	F	G	H	A	B
SOPN-52-00			\$2647.58	\$2822.42	\$2997.24	\$3179.40	\$3346.95	\$4132.90	\$4570.77	\$5357.59	\$4837.23	\$5596.54

The following options require modification of the product number.

Stain Repellent

To specify, add **P** to the end of the product number (Large Square add **\$114.89** list; Rectangle add **\$134.87** list);

Example: SOPN-2238-00HP

Note: For mixed grade fabric surfaces, please refer to the electronic design and specification tools for these prices.

Chick Pouf

Round - No Back

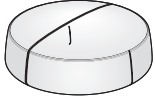

SOPN-2265
Class QA

Features

- Includes: Seat and base with specifiable top-stitch thread around the top, across the middle of the top, and four vertical seams (every 90°).
- Available with black hard or felt glides or six black braking casters.
- Braking casters lock into place when weight is loaded on the pouf.
- COM yardage:
 Seat and Base matching: 8.0
 Seat only: 4.0
 Base only: 4.0

Specification Tips

- Fabric will be applied railroaded.
- Linear or patterned fabric is not recommended due to the manner in which fabric is applied.
- Casters must be specified at time of purchase. Cannot be retrofitted in the field.

Dimensions

H: 17"(432mm) D: 65"(1651mm)

To Order, Specify:

1) Product number, including:

1 Seat Surface Material:

- 2** Fabric
- 3** Faux Leather

2 Base Surface Material:

- 2** Fabric
- 3** Faux Leather

3 Glide/Caster Option:

- H** Hard Glides
- K** Felt Glides
- B** Braking Casters
(add **\$614.43** list)

2) Seat surface color.

3) Base surface color.

4) Thread color.

Number	Fabric									Leather		
	1 2	3	A	B	C	D	E	F	G	H	A	B
SOPN- 65-00			\$4895.50	\$5195.22	\$5494.98	\$5807.16	\$6094.38	\$7443.14	\$8192.46	\$9541.22	N/A	N/A

The following options require modification of the product number.

Stain Repellent

To specify, add **P** to the end of the product number (add **\$229.80** list); **Example:** SOPN-2265-00HP

Note: For mixed grade fabric surfaces, please refer to the electronic design and specification tools for these prices.

Sprig Tables

Rectangle

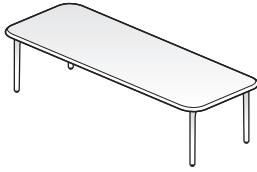

SORA-5320-P
Class QA

Features

- Includes: Table top and legs.
- Top available in Black or Polar painted MDF or planked wood in White Oak or Walnut.
- Planked wood tops are designed to be unique, using solid wood planks with a clear, low-gloss finish showing natural variation.
- Legs: Painted cast aluminum.

To Order, Specify:

1) Product number, including:

1 Surface Material:

- P** Painted MDF
- W** Planked Wood

2) Top color.

3) Leg color.

Height	Depth	Width	Number ①	Painted	White Oak	Walnut
12"(305mm)	20"(508mm)	53"(1346mm)	SORA-5320-■	\$1539.70	\$3849.24	\$4683.99

Round

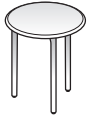

SODC-1616-P



SODB-2424-P
Class QA

Features

- Includes: Table top and legs.
- Top available in Black or Polar painted MDF or planked wood in White Oak or Walnut.
- Planked wood tops are designed to be unique, using solid wood planks with a clear, low-gloss finish showing natural variation.
- Legs: Painted cast aluminum.

To Order, Specify:

1) Product number, including:

1 Surface Material:

- P** Painted MDF
- W** Planked Wood

2) Top color.

3) Leg color.

Height	Depth	Number ①	Painted	White Oak	Walnut
17"(432mm)	16"(406mm)	SODC-1616-■	\$1094.46	\$2226.04	\$ 2411.56
14"(356mm)	24"(610mm)	SODB-2424-■	1205.76	2986.62	3431.79

Single Desk

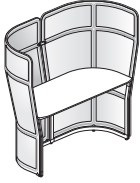

HOAS-2
Class QA

Features

- Includes: Two screens, one attached worksurface with painted steel structure.
- Worksurface available in painted MDF, high-pressure laminate (HPL) or wood veneer.
- Worksurface fixed height 29"(737mm).
- Screens available in King II, Class II, and Maya II fabrics only. COM not available.
- Ships unassembled.

Specification Tips

- Screens are non-load bearing.
- Not reconfigurable.
- Will not accept monitor arms, keyboard pads or attached or suspended pedestals.
- Screens are not tackable or pinnable.
- Separately specified power or USB module field installed.
- For more detailed dimensions, refer to specification guide.

Dimensions

H: 58"(1473mm) D: 28"(711mm) W: 65"(1651mm)

To Order, Specify:

1) Product number, including:

1 Surface Material:

- P** Painted MDF
- L** Laminate
- W** Wood

2) Screen inner material.

3) Screen outer material.

4) Desk surface and color.

5) Edgeband color (if applicable).

6) Trim color.

Screen Grade C

Number ①	Painted MDF Worksurface	HPL Worksurface		Wood Worksurface	
	Price	A	B	A	B
HOAS-2-N ■ NNS	\$12246.89	\$11706.58	\$11796.63	\$12336.95	\$12426.99

Screen Grade D

Number ①	Painted MDF Worksurface	HPL Worksurface		Wood Worksurface	
	Price	A	B	A	B
HOAS-2-N ■ NNS	\$13147.39	\$12607.08	\$12697.13	\$13237.45	\$13327.49

Note: For mixed grade fabric surfaces, please refer to the electronic design and specification tools for these prices.

Note: The Openest screen is made with polyester fabric adhered to a polyester core. The screen is compliant with UL-1286 flammability requirements and California Technical Bulletin TB-117-2013 requirements. The fabric covering is compliant with NFPA 701 requirements. Consult your local code authority to assure that screens are compliant prior to installation.

Double Desk

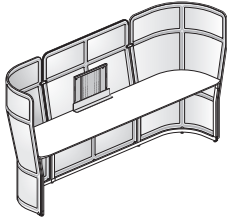

HOAD-3
Class QA

Features

- Includes: Three screens, one attached worksurface with painted steel structure and monitor mount (if applicable).
- Worksurface available in painted MDF, high-pressure laminate (HPL) or wood veneer.
- Worksurface fixed height 29"(737mm).
- Monitor mount accepts 40"(1016mm)-42"(1067mm) monitors.
- Screens available in King II, Class II and Maya II fabrics only. COM not available.
- Monitor mount.
 - Table mounting bracket mounts unit to worksurface and supports monitor in a viewing position. Standard in black.
 - Front and rear trim match trim specification and hides cables and wires behind the monitor.
- Ships unassembled.

Specification Tips

- Not reconfigurable.
- Soft Storage cannot be used on the Double Desk.
- Coat Hook not to be used with mounted monitor.
- Will not accept monitor arms, keyboard pads or attached or suspended pedestals.
- Screens are not tackable or pinnable.
- Separately specified power or USB module field installed.
- For more detailed dimensions, refer to specification guide.

Dimensions

H: 58"(1473mm) D: 28"(711mm) W: 117"(2972mm)

To Order, Specify:

1) Product number, including:

1 Surface Material:

- P** Painted MDF
- L** Laminate
- W** Wood

2 Monitor Mount:

- N** No Monitor Mount
- M** Monitor Mount (add **\$1801.02** list)

- 2) Screen inner material.
- 3) Screen outer material.
- 4) Desk surface and color.
- 5) Edgeband color (if applicable).
- 6) Trim color.

Screen Grade C					
Number ①②	Painted MDF Worksurface	HPL Worksurface		Wood Worksurface	
	Price	A	B	A	B
HOAD-3-N ■ ■ NS	\$18370.34	\$17469.85	\$17649.94	\$18460.41	\$18640.52

Screen Grade D					
Number ①②	Painted MDF Worksurface	HPL Worksurface		Wood Worksurface	
	Price	A	B	A	B
HOAD-3-N ■ ■ NS	\$19631.08	\$18730.59	\$18910.68	\$19721.15	\$19901.26

Note: For mixed grade fabric surfaces, please refer to the electronic design and specification tools for these prices.

Note: The Openest screen is made with polyester fabric adhered to a polyester core. The screen is compliant with UL-1286 flammability requirements and California Technical Bulletin TB-117-2013 requirements. The fabric covering is compliant with NFPA 701 requirements. Consult your local code authority to assure that screens are compliant prior to installation.

Privacy Desk

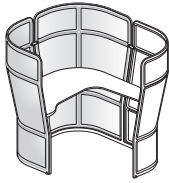

HOAP-3
(Right-hand shown)
Class QA

Features

- Includes: Three screens, one attached worksurface and steel structure.
- Worksurface available in painted MDF, high-pressure laminate (HPL) or wood veneer.
- Worksurface fixed height 29" (737mm).
- Screens available in King II, Class II and Maya II fabrics only. COM not available.
- Painted steel structure.
- Ships unassembled.

Specification Tips

- Screens are non-load bearing.
- Not reconfigurable.
- Will not accept monitor arms, keyboard pads or attached or suspended pedestals.
- Screens are not tackable or pinnable.
- Separately specified power or USB module field installed.
- Handedness determined by return location.
- For more detailed dimensions, refer to specification guide.

Dimensions

H: 58" (1473mm) D: 65" (1651mm) W: 55" (1397mm)

To Order, Specify:

1) Product number, including:

1 Surface Material:

- P** Painted MDF
- L** Laminate
- W** Wood

2 Handedness:

- R** Right-Hand
- L** Left-Hand

2) Screen inner material.

3) Screen outer material.

4) Desk surface and color.

5) Edgeband color (if applicable).

6) Trim color.

Screen Grade C					
Number 1 2	Painted MDF Worksurface Price	HPL Worksurface		Wood Worksurface	
		A	B	A	B
HOAP-3-N <input type="checkbox"/> N <input type="checkbox"/> S	\$17830.06	\$17109.65	\$17244.73	\$17920.10	\$18055.22

Screen Grade D					
Number 1 2	Painted MDF Worksurface Price	HPL Worksurface		Wood Worksurface	
		A	B	A	B
HOAP-3-N <input type="checkbox"/> N <input type="checkbox"/> S	\$19090.80	\$18370.39	\$18505.47	\$19180.84	\$19315.96

Note: For mixed grade fabric surfaces, please refer to the electronic design and specification tools for these prices.

Note: The Openest screen is made with polyester fabric adhered to a polyester core. The screen is compliant with UL-1286 flammability requirements and California Technical Bulletin TB-117-2013 requirements. The fabric covering is compliant with NFPA 701 requirements. Consult your local code authority to assure that screens are compliant prior to installation.

Single Booth

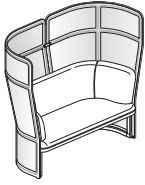

HOAB-2
Class QA

Features

- Includes: Two screens, one attached sofa with specifiable top-stitch thread and painted steel structure.
- Screens available in King II, Class II and Maya II fabrics only. COM not available.
- Ships unassembled.
- COM yardage/sq. footage (sofa): 3.25 / 58.5

Specification Tips

- Screens are non-load bearing.
- Not reconfigurable.
- Screens are not tackable or pinnable.
- Sofa accepts separately specified and field installed Hideaway Power Module.
- Sofa fabric applied railroaded.
- Linear or patterned fabric not recommended due to the manner in which fabric is applied.
- For more detailed dimensions, refer to specification guide.

Dimensions

SH: 18"(457mm) SD: 20"(508mm) SW: 44"(1118mm)
H: 58"(1473mm) TD: 30"(762mm) TW: 65"(1651mm)

To Order, Specify:

1) Product number, including:

1 Seat Surface Material:

- 1 Leather
- 2 Fabric
- 3 Faux Leather

2) Screen inner material.

3) Screen outer material.

4) Sofa material and color.

5) Thread color.

6) Trim color.

Screen Grade C

Number ①	Seat Fabric								Leather	
	A	B	C	D	E	F	G	H	A	B
HOAB-2-NNNN	\$14858.37	\$15128.51	\$15173.56	\$15308.62	\$15488.74	\$15623.79	\$15938.98	\$16038.05	\$18460.41	\$19360.88

Screen Grade D

Number ①	Seat Fabric								Leather	
	A	B	C	D	E	F	G	H	A	B
HOAB-2-NNNN	\$15758.87	\$16029.01	\$16074.06	\$16209.12	\$16389.24	\$16524.29	\$16839.48	\$16938.55	\$19360.91	\$20261.38

The following options require modification of the product number.

Stain Repellent

To specify, add **P** to the end of the product number (add **\$129.44** list); **Example:** HOAB-2-2NNNNP

Notes: For mixed grade fabric surfaces, please refer to the electronic design and specification tools for these prices.

Note: The Openest screen is made with polyester fabric adhered to a polyester core. The screen is compliant with UL-1286 flammability requirements and California Technical Bulletin TB-117-2013 requirements. The fabric covering is compliant with NFPA 701 requirements. Consult your local code authority to assure that screens are compliant prior to installation.

Double Booth

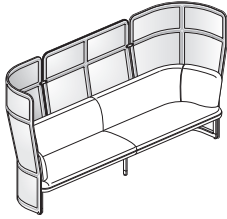

HOA1-3
Class QA

Features

- Includes: Three screens, attached double sofa with specifiable top-stitch thread and painted steel structure. Double sofa shipped in two pieces.
- Screens available in King II, Class II and Maya II fabrics only. COM not available.
- Ships unassembled.
- COM yardage/sq. footage (sofa): 6 / 108

Specification Tips

- Screens are non-load bearing.
- Not reconfigurable.
- Screens are not tackable or pinnable.
- Separately specified Hideaway Power Module field installed.
- Sofa fabric applied railroaded.
- For more detailed dimensions, refer to specification guide.

Dimensions

SH: 18"(457mm) SD: 20"(508mm) SW: 96"(2438mm)
 H: 58"(1473mm) TD: 30"(762mm) TW: 108"(2743mm)

To Order, Specify:

1) Product number, including:

1 Seat Surface Material:

- 1** Leather
- 2** Fabric
- 3** Faux Leather

2) Screen inner material.

3) Screen outer material.

4) Sofa surface and color.

5) Thread color.

6) Trim color.

Screen Grade C										
Number ①	Seat Fabric								Leather	
	A	B	C	D	E	F	G	H	A	B
HOA1-3- NNNN	\$27915.70	\$28456.01	\$28546.07	\$28816.19	\$29176.41	\$29446.57	\$30076.92	\$30275.03	\$35119.74	\$36920.79

Screen Grade D										
Number ①	Seat Fabric								Leather	
	A	B	C	D	E	F	G	H	A	B
HOA1-3- NNNN	\$29176.44	\$29716.75	\$29806.81	\$30076.93	\$30437.15	\$30707.31	\$31337.66	\$31535.77	\$36380.48	\$38181.53

The following options require modification of the product number.

Stain Repellent

To specify, add **P** to the end of the product number (add **\$238.99** list); **Example:** HOA1-3-2NNNNP

Note: For mixed grade fabric surfaces, please refer to the electronic design and specification tools for these prices.

Note: The Openest screen is made with polyester fabric adhered to a polyester core. The screen is compliant with UL-1286 flammability requirements and California Technical Bulletin TB-117-2013 requirements. The fabric covering is compliant with NFPA 701 requirements. Consult your local code authority to assure that screens are compliant prior to installation.

Corner Booth

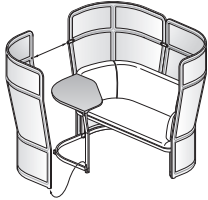

HOAC-3
(Right-hand shown)
Class QA

Features

- Corner Booth must be **ordered as two individual items**:
 - Item 1 includes: Three screens, one attached sofa with specifiable top-stitch thread and painted steel structure.
 - Item 2 includes: Corner worksurface.
- Screens available in King II, Class II and Maya II fabrics only. COM not available.
- Worksurface available in painted MDF, high-pressure laminate (HPL) or wood veneer.
- Worksurface fixed height is 29"(737mm).
- Ships unassembled.
- COM yardage/sq. footage (sofa): 3.25 / 58.5

Specification Tips

- Screens are non-load bearing.
- Will not accept monitor arms, keyboard pads or attached or suspended pedestals.
- Not reconfigurable.
- Screens are not tackable or pinnable.
- Separately specified power or USB module field installed.
- Sofa accepts separately specified and field installed Hideaway Power Module.
- Handedness determined from a seated position.
- Sofa fabric applied railroaded.
- Linear or patterned fabric not recommended due to the manner in which fabric is applied.
- For more detailed dimensions, refer to specification guide.

Dimensions

SH: 18"(457mm) SD: 20"(508mm) SW: 44"(1118mm)
 H: 58"(1473mm) TD: 55"(1397mm) TW: 65"(1651mm)

Worksurface

H: 29"(737mm) D: 24"(610mm) W: 29"(737mm)

To Order, Specify:

ITEM #1

1) Product number, including:

1 Seat Surface Material:

- 1 Leather
- 2 Fabric
- 3 Faux Leather

2 Handedness:

- R Right-Hand
- L Left-Hand

- 2) Screen inner material.
- 3) Screen outer material.
- 4) Sofa surface and color.
- 5) Thread color.
- 6) Trim color.

To Order, Specify:

ITEM #2

1) Product number, including:

1 Surface Material:

- P Painted MDF
- L Laminate
- W Wood

2 Handedness:

- R Right-Hand
- L Left-Hand

- 2) Surface and color.
- 3) Edgeband color (if applicable).

ITEM #1 – Screens and Sofa

Number	Screen Grade C								Leather			
	Seat Fabric								A	B		
	1	2	A	B	C	D	E	F			G	H
HOAC-3- NN N			\$19811.15	\$20081.29	\$20126.34	\$20261.40	\$20441.52	\$20576.57	\$20891.76	\$20990.83	\$23413.19	\$24313.66

Number	Screen Grade D								Leather			
	Seat Fabric								A	B		
	1	2	A	B	C	D	E	F			G	H
HOAC-3- NN N			\$21071.89	\$21342.03	\$21387.08	\$21522.14	\$21702.26	\$21837.31	\$22152.50	\$22251.57	\$24673.93	\$25574.40

ITEM #2 – Worksurface

Number 1 2	Painted MDF		HPL		Wood	
	Price		A	B	A	B
	HOAC-W-N N S		\$1035.56	\$675.38	\$738.42	\$1035.56

The following options require modification of the product number.

Stain Repellent

To specify, add **P** to the end of the product number (add **\$129.44** list); **Example:** HOAC-3-2NNRNP

Note: For mixed grade fabric surfaces, please refer to the electronic design and specification tools for these prices.

Note: The Openest screen is made with polyester fabric adhered to a polyester core. The screen is compliant with UL-1286 flammability requirements and California Technical Bulletin TB-117-2013 requirements. The fabric covering is compliant with NFPA 701 requirements. Consult your local code authority to assure that screens are compliant prior to installation.

Privacy Booth

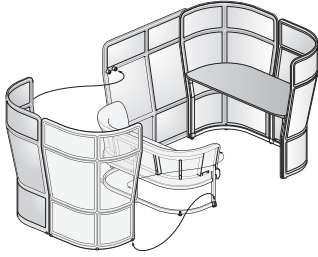

HOAE-5
(Left-hand shown)
Class QA

Features

- Privacy Booth must be **ordered as two individual items**:
 -Item 1 includes: Five screens, one attached sofa with specifiable top-stitch thread and painted steel structure.
 -Item 2 includes: Worksurface.
- Screens available in King II, Class II and Maya II fabrics only. COM not available.
- Worksurface available in painted MDF, high-pressure laminate (HPL) or wood veneer.
- Worksurface fixed height is 29"(737mm).
- Open space between the sofa and worksurface is 42"(1067mm).
- Ships unassembled.
- COM yardage/sq. footage (sofa): 3.25 / 58.5

Specification Tips

- Screens are non-load bearing.
- Not reconfigurable.
- Handedness determined by sofa side.
- Will not accept monitor arms, keyboard pads or attached or suspended pedestals.
- Screens are not tackable or pinnable.
- Separately specified power or USB module field installed.
- Sofa accepts separately specified and field installed Hideaway Power Module.
- Sofa fabric applied railroaded.
- Linear or patterned fabric not recommended due to the manner in which fabric is applied.
- For more detailed dimensions, refer to specification guide.

Dimensions

SH: 18"(457mm) SD: 20"(508mm) SW: 44"(1118mm)
 H: 58"(1473mm) TD: 67"(1702mm) TW: 94"(2388mm)

Worksurface

H: 29"(737mm) D: 25"(635mm) W: 57"(1448mm)

To Order, Specify:

ITEM #1

1) Product number, including:

1 Seat Surface Material:

- 1 Leather
- 2 Fabric
- 3 Faux Leather

2 Handedness:

- R Right-Hand
- L Left-Hand

2) Screen inner material.

3) Screen outer material.

4) Sofa surface and color.

5) Thread color.

6) Trim color.

To Order, Specify:

ITEM #2

1) Product number, including:

1 Surface Material:

- P Painted MDF
- L Laminate
- W Wood

2) Surface and color.

3) Edgeband color (if applicable).

ITEM #1 - Screens and Sofa

Number	Screen Grade C								Leather	
	Seat Fabric		C	D	E	F	G	H	A	B
	1	2								
HOAE-5- ■ NN ■ N	\$28365.97	\$28636.11	\$28681.16	\$28816.22	\$28996.34	\$29131.39	\$29446.58	\$29545.65	\$31968.01	\$32868.48

Number	Screen Grade D								Leather	
	Seat Fabric		C	D	E	F	G	H	A	B
	1	2								
HOAE-5- ■ NN ■ N	\$29986.87	\$30257.01	\$30302.06	\$30437.12	\$30617.24	\$30752.29	\$31067.48	\$31166.55	\$33588.91	\$34489.38

ITEM #2 - Worksurface

Number 1	Painted MDF	HPL		Wood	
	Price	A	B	A	B
HOAE-W-N ■ NNS	\$1395.79	\$855.48	\$945.53	\$1485.85	\$1575.89

The following options require modification of the product number.

Stain Repellent

To specify, add **P** to the end of the product number (add **\$129.44** list); **Example:** HOAE-5-2NNRNP

Note: For mixed grade fabric surfaces, please refer to the electronic design and specification tools for these prices.

Note: The Openest screen is made with polyester fabric adhered to a polyester core. The screen is compliant with UL-1286 flammability requirements and California Technical Bulletin TB-117-2013 requirements. The fabric covering is compliant with NFPA 701 requirements. Consult your local code authority to assure that screens are compliant prior to installation.

Conference Booth

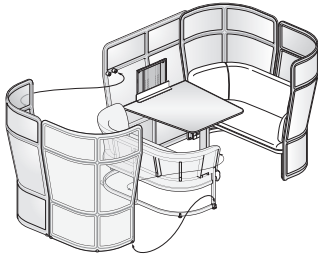

HOAW-5
(shown with monitor mount)
Class QA

Features

- Conference Booth must be **ordered as two individual items:**
 - Item 1 includes: Five screens, two attached sofas with specifiable top-stitch thread and painted steel structure.
 - Item 2 includes: Worksurface and monitor mount (if specified).
- Screens available in King II, Class II and Maya II fabrics only. COM not available.
- Worksurface available in painted MDF, high-pressure laminate (HPL) or wood veneer.
- Worksurface fixed height is 29"(737mm).
- Monitor mount accepts 30"(762mm)-32"(813mm) monitor only.
 - Table mounting bracket mounts unit to worksurface and supports monitor in a viewing position. Standard in black.
 - Front and rear trim match trim specification and hides cables and wires behind the monitor.
- Ships unassembled.
- COM yardage/sq. footage (sofa): 3.25 / 58.5

Specification Tips

- Not reconfigurable.
- Will not accept monitor arms, keyboard pads or attached or suspended pedestals.
- Screens are not tackable or pinnable.
- Separately specified power or USB module field installed.
- Sofa accepts separately specified and field installed Hideaway Power Module.
- Sofa fabric applied railroaded.
- Linear or patterned fabric not recommended due to the manner in which fabric is applied.
- For more detailed dimensions, refer to specification guide.

Dimensions

SH: 18"(457mm) SD: 20"(508mm) SW: 44"(1118mm)
H: 58"(1473mm) TD: 67"(1702mm) TW: 94"(2388mm)

Worksurface

H: 29"(737mm) D: 46"(1168mm) W: 40"(1016mm)

To Order, Specify:

ITEM #1

1) Product number, including:

1 Seat Surface Material:

- 1 Leather
- 2 Fabric
- 3 Faux Leather

2) Screen inner material.

3) Screen outer material.

4) Sofa surface and color.

5) Thread color.

6) Trim color.

To Order, Specify:

ITEM #2

1) Product number, including:

1 Surface Material:

- P Painted MDF
- L Laminate
- W Wood

2 Monitor Mount:

- N No Monitor Mount
- M Monitor Mount (add \$1801.02 list)

2) Surface and color.

3) Edgeband color (if applicable).

4) Trim color.

ITEM #1 - Screens and Sofa

Number 1	Screen Grade C Seat Fabric								Leather	
	A	B	C	D	E	F	G	H	A	B
HOAW-5-NNNN	\$35479.96	\$36020.27	\$36110.33	\$36380.45	\$36740.67	\$37010.83	\$37641.18	\$37839.29	\$42684.00	\$44485.05

Number 1	Screen Grade D Seat Fabric								Leather	
	A	B	C	D	E	F	G	H	A	B
HOAW-5-NNNN	\$37100.86	\$37641.17	\$37731.23	\$38001.35	\$38361.57	\$38631.73	\$39262.08	\$39460.19	\$44304.90	\$46105.95

ITEM #2 - Worksurface

Number 1 2	Painted MDF	HPL		Wood	
	Price	A	B	A	B
HOAW-W-N NS	\$1575.89	\$855.48	\$990.56	\$1665.93	\$1801.05

The following options require modification of the product number.

Stain Repellent

To specify, add **P** to the end of the product number (add \$258.89 list); **Example:** HOAW-5-2NNNNP

Note: For mixed grade fabric surfaces, please refer to the electronic design and specification tools for these prices.

Note: The Openest screen is made with polyester fabric adhered to a polyester core. The screen is compliant with UL-1286 flammability requirements and California Technical Bulletin TB-117-2013 requirements. The fabric covering is compliant with NFPA 701 requirements. Consult your local code authority to assure that screens are compliant prior to installation.

Accessories

Coat Hook

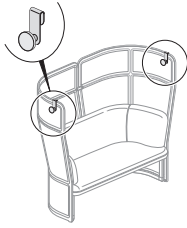

HOCH
Class QA

Features

- Includes: One white oak coat hook.
- Painted steel bracket with white oak wood surface.
- Maximum weight load is 10 lbs.

Specification Tips

- Can be used on Plume screens.
- Cannot be hung on the backside of Double Desk with monitor mount.

Dimensions

H: 7.7"(196mm) D: 16"(406mm) W: 3"(76mm)

To Order, Specify:

- 1) Product number.
- 2) Trim color.

Number	Price
HOCH-0000	\$278.24

Soft Storage

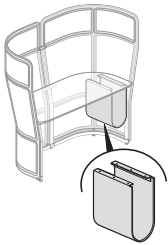

HOUS
Class QA

Features

- Includes: One soft storage unit with attachment hardware.
- Maximum weight capacity is 30 lbs.
- Available in Big Arrow fabric only. COM not available.

Specification Tips

- Can be used on worksurfaces 16"(406mm) or deeper.
- Not for use on sofas.
- Not for use on Double Desk.

Dimensions

H: 12"(305mm) D: 16"(406mm) W: 8.5"(216mm)

To Order, Specify:

- 1) Product number.
- 2) Fabric color.

Number	Price
HOUS-0000	\$463.75

Pillows

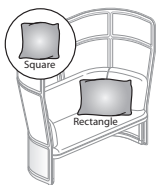

HOUN
Class QA

Features

- Includes: One pillow with 100% polyester fill.
- Available in square or rectangle.
- COM yardage: 0.75

To Order, Specify:

- 1) Product number.
- 2) Fabric color.

Description	Height	Width	Number	Fabric							
				A	B	C	D	E	F	G	H
Square	18"(457mm)	18"(457mm)	HOUN-S	\$287.54	\$604.78	\$634.41	\$664.09	\$693.79	\$780.86	\$983.98	\$1047.83
Rectangle	14"(355mm)	19"(482mm)	HOUN-R	287.54	604.78	634.41	664.09	693.79	780.86	983.98	1047.83

The following options require modification of the product number.

Stain Repellent

To specify, add **-P** to the end of the product number (add **\$29.88** list); **Example: HOUN-S-P**

Hideaway Power Module

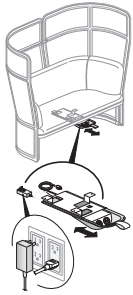

HOPD

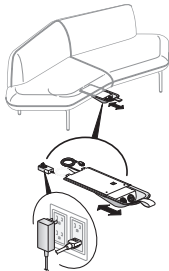

Class QA - GSA: Open Market

Features

- Includes: Power drawer, soft drawer pull, power and/or USB ports and mounting hardware.
- Power options include: One power port and one USB port, two power ports, or two USB ports.
- UL listed power outlet provides one NEMA 5-15R outlet.
- USB outlet consists of two USB outlets with 1000mA of charging per USB outlet powered from UL listed transformer.
- Can be used on Openest booth sofa or Feather sofa.
- Mounts to under structure of sofa.
- Tray slides 6" (152mm) forward.
- Drawer available in supplier white only.
- Drawer pull in orange only.

Specification Tips

- For use with 120 volt 60 hertz power source only.
- Drawer has one cord with plug (NEMA 5-15P) and one cord with 2" (51mm) x 1" (25mm) x 3" (76mm) voltage transformer plug. Transformer may block adjacent outlets (see illustration).
- Cord reach is 30" (762mm) from back of hideaway power module.
- Requires field installation.
- Application may require approval of local authority having jurisdiction (AHJ); ensure compliance before placing orders and installing.

To Order, Specify:

- 1) Product number, including:
(No finish specification required.)

1 Sofa Type:

- B** Booth
- F** Feather

Description	Height	Depth	Width	Number ①	Price
1 Power, 1 USB Port	3.2"(81mm)	15.5"(394mm)	9.2"(234mm)	HOPD-0006-■11100	\$1242.86
2 Power Ports				HOPD-0006-■12000	1150.11
2 USB Ports				HOPD-0006-■10200	1502.57

Bezel Utility Module

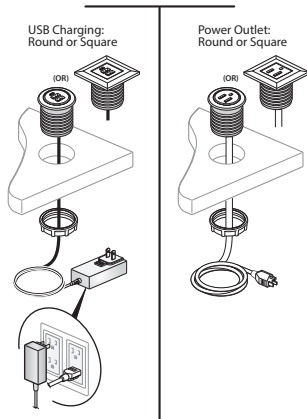

EURT-0072-1100
EURT-0072-1010
Class QA



Features

- Includes: Either a round or square faced Power Module and mounting hardware.
- For use on surfaces 0.75"(19mm) - 1.44"(37mm) thick.
- Available with either:
 - One power outlet (NEMA 5-15R)
 - One two port USB charger. Consists of two USB outlets with 1000mA of charging power (5 volts) per USB outlet.
- Available in black or supplier white only.

Specification Tips

- For use with 120 volt 60 hertz power source only.
- Power configuration has one cord with plug (NEMA 5-15P).
- USB configuration has one cord with 2"(51mm) x 1"(25mm) x 3"(76mm) voltage transformer plug. Transformer may block adjacent outlets (see illustration).
- Requires field cut 1.75"(44mm) hole and field installation.
- Application may require approval of local authority having jurisdiction (AHJ); ensure compliance before placing orders and installing.

To Order, Specify:

1) Product number, including:

1 Shape:

- S** Square
- C** Round

2 Color Options:

- B** Black
- W** White

Description	Height	Depth	Width	Number	1 2	Price
6' Cord						
Power		1.75"(44mm)		EURT-0072-1100	■ ■	\$ 132.85
USB				EURT-0072-1010	■ ■	398.58
12' Cord						
Power		1.75"(44mm)		EURT-00E4-1100	■ ■	\$ 227.75
USB				EURT-00E4-1010	■ ■	493.48

Data Bezel

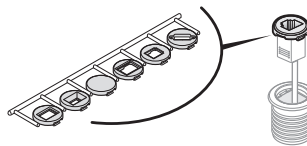

EURT-0000-N001CB
EURT-0000-N001CW

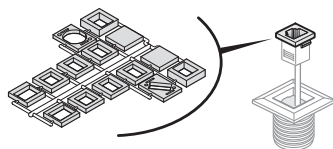

EURT-0000-N001SB
EURT-0000-N001SW
Class QA

Features

- Includes one round or square bezel for the Bezel Utility Module.
- Available in black or supplier white only.

To Order, Specify:

1) Product number.
(No finish specification required.)

Description	Number	Price
Round		
Black	EURT-0000-N001CB	\$132.85
White	EURT-0000-N001CW	132.85
Square		
Black	EURT-0000-N001SB	\$132.85
White	EURT-0000-N001SW	132.85

Openest Resources

Surfaces Materials

Index

Warranty

Surface Materials

Finish Color Legend

Wood

Grade A

Double Cut

2P-RL	Applegate
CQ-HKL	Auburn
CQ-HBF	Clove
WE-RD	Dune
WJ-RE	Ebony
2N-RL	Echo
W3-HR	Harbor
WE-RT	Melba
W4-PB	Pebble
CQ-WG	Walnut Grove

Grade B

Cherry

VC-CA1	Amber
VC-W23	American
VC-CPK	Bourbon
VC-HKP	Burgundy
VC-W33	Caramel
VC-W30	Heritage
VC-W32	Pacific
VC-HKA	Toffee

Maple

VP-LM	Light
VP-N	Natural

Maple Quarter Cut

NM-N	Natural
------	---------

Oak

VJ-HKC	Urban
--------	-------

Rift Cut White Oak

NR-W35	Clear
NR-W15	Espresso
NR-W40	Mocha

Walnut

VR-HKG	Colombian
VR-W15	Espresso
VR-W31	Retro

Walnut Quarter Cut

NW-W35	Clear
NW-W31	Retro

Planked Wood

VB-W35	Plank Oak
VH-W35	Plank Walnut

HPL

Grade A

Solid Color

H-34	Beige
H-AK	Chalk
H-8J	Charcoal
H-3J	Graphite
H-62	Gray Tone
H-WL	Linen
H-3P	Platinum
H-AA	Putty
H-3E	Smoke

Patterned

H-P1	Linen Casual
H-P2	Linen Classic
H-P3	Linen Crisp
H-P4	Linen Flax

Wood Grain

H-B06	Brazilwood
H-E79	Colombian Walnut
H-AE	Maple
H-DYP	New Age Oak
H-E15	River Cherry
H-C09	Williamsburg Cherry

Grade B

Premium Wood Grain

H-C8	Blonde Modern Cherry
H-D1	Daintree
H-KP	Field Elm
H-KN	Grey Elm
H-KM	Landmark Wood
H-D2	Mocha Modern Cherry
H-KL	Neo Walnut
H-KR	Phantom Ecu
H-KS	Phantom Pearl
H-C9	Spiced Modern Cherry

Edgeband

Solid Color

HP-34	Beige
HP-AK	Chalk
HP-8J	Charcoal
HP-3J	Graphite
HP-62	Gray Tone
HP-WL	Linen
HP-3P	Platinum
HP-AA	Putty
HP-3E	Smoke

Patterned Edgeband

HP-P1	Linen Casual
HP-P2	Linen Classic
HP-P3	Linen Crisp
HP-P4	Linen Flax

Wood Grain

HP-C8	Blonde Modern Cherry
HP-B06	Brazilwood
HP-E79	Colombian Walnut
HP-D1	Daintree
HP-KP	Field Elm
HP-KN	Grey Elm
HP-KM	Landmark Wood
HP-AE	Maple
HP-D2	Mocha Modern Cherry
HP-KL	Neo Walnut
HP-DYP	New Age Oak
HP-KR	Phantom Ecu
HP-KS	Phantom Pearl
HP-E15	River Cherry
HP-C9	Spiced Modern Cherry
HP-C09	Williamsburg Cherry

Ply-Edge

HP-PW	Ply-Edge
-------	----------

Trim

TR-K	Charcoal
TR-RR	Rusty Red
TR-PLS	Smooth Plaster

Painted MDF

PW-F	Black
PW-AK	Chalk
PW-PL	Polar

Thread

NS-IE	Accent Orange
NS-F	Black
NS-RR	Rusty Red
NS-SN	Sand
NS-PLS	Smooth Plaster

ALERT: These materials are current, however they are being considered for future obsolescence due to low volume.

<h3>Wood</h3> <table> <tr><td>VJ-W42</td><td>Brindle</td></tr> <tr><td>2R-RL</td><td>Butternut</td></tr> <tr><td>NW-W15</td><td>Espresso</td></tr> <tr><td>NP-W08</td><td>Golden</td></tr> <tr><td>NP-W07</td><td>Light</td></tr> <tr><td>NX-U</td><td>Medium</td></tr> <tr><td>VR-W12</td><td>Naturally Walnut</td></tr> <tr><td>WC-RW</td><td>Wenge</td></tr> </table>	VJ-W42	Brindle	2R-RL	Butternut	NW-W15	Espresso	NP-W08	Golden	NP-W07	Light	NX-U	Medium	VR-W12	Naturally Walnut	WC-RW	Wenge	<h3>HPL</h3> <table> <tr><td>H-AM</td><td>Amber Cherry</td></tr> <tr><td>H-AD</td><td>Medium Cherry</td></tr> </table>	H-AM	Amber Cherry	H-AD	Medium Cherry	<h3>Edgeband</h3> <table> <tr><td>HP-AM</td><td>Amber Cherry</td></tr> <tr><td>HP-AD</td><td>Medium Cherry</td></tr> </table>	HP-AM	Amber Cherry	HP-AD	Medium Cherry	<h3>Trim</h3> <table> <tr><td>TR-IE</td><td>Accent Orange</td></tr> </table>	TR-IE	Accent Orange
VJ-W42	Brindle																												
2R-RL	Butternut																												
NW-W15	Espresso																												
NP-W08	Golden																												
NP-W07	Light																												
NX-U	Medium																												
VR-W12	Naturally Walnut																												
WC-RW	Wenge																												
H-AM	Amber Cherry																												
H-AD	Medium Cherry																												
HP-AM	Amber Cherry																												
HP-AD	Medium Cherry																												
TR-IE	Accent Orange																												

Forestry Stewardship Council (FSC) Statement:

In our continuing support of sustainable forestry and responsible purchasing, Haworth North America is offering FSC certified wood products at no up-charge. By providing FSC certified material, Haworth is supporting our client's green building goals and demonstrating our collective commitment to source materials more sustainably.

Haworth will provide to you the necessary FSC-certified paperwork with your shipment. For more information, FAQs, and a complete FSC product list (including product exceptions), go to the Library and search FSC.

Haworth FSC Trademark License #FSC-C002821

Surface Materials

Fabrics/Color Legends

Seating Fabrics

- Grade A**
 (4H) Blanket
 (3J) Hobson
 (4J) Morse
 (3L) Novelty
 (3A) Tellure
 (XJ) Wellington Faux Leather
- Grade B**
 (4N) Diagonale
 (4Z) Element
 (S6) Floyd by Kvadrat
 (S4) Kaleidoscope
 (SN) Pemberton
 (4V) Ramie
 (MV) Tech
- Grade C**
 (6K) Dots
 (67) King II
 (68) Maya II
 (4T) Oceanic
 (3S) Scapes
- Grade D**
 (LW) Atlas by Kvadrat
 (4D) Big Arrow
 (1K) Big Diagonale
 (NV) Clara 2 by Kvadrat
 (66) Class II
 (JB) Cotswold
 (6M) Main Line Flax
 (S7) Melange Nap by Kvadrat
 (RP) Recheck by Kvadrat
- Grade E**
 (XG) Brisa Faux Leather
 (SY) Steelcut Trio by Kvadrat
- Grade F**
 (SV) Divina Melange 3 by Kvadrat
 (SZ) Hallingdal 65 by Kvadrat

Seating Leathers

- Grade A**
 (XP) Plains Leather
- Grade B**
 (XE) Nature Leather

Pillow Fabrics

- Grade A**
 (4H) Blanket
 (3J) Hobson
 (4J) Morse
 (3L) Novelty
 (2A) Pixel
 (3A) Tellure
- Grade B**
 (4N) Diagonale
 (4Z) Element
 (4E) English Tweed
 (S6) Floyd by Kvadrat
 (S4) Kaleidoscope
 (4V) Ramie
 (S8) Reflect by Kvadrat
 (MV) Tech
- Grade C**
 (6K) Dots
 (67) King II
 (68) Maya II
 (4T) Oceanic
 (3S) Scapes
- Grade D**
 (LW) Atlas by Kvadrat
 (4D) Big Arrow
 (1K) Big Diagonale
 (NV) Clara 2 by Kvadrat
 (66) Class II
 (JB) Cotswold
 (6M) Main Line Flax
 (S7) Melange Nap by Kvadrat
 (RP) Recheck by Kvadrat
- Grade E**
 (SY) Steelcut Trio by Kvadrat
- Grade F**
 (SV) Divina Melange 3 by Kvadrat
 (SZ) Hallingdal 65 by Kvadrat

Screen Fabrics

- Grade C**
 (67) King II
 (68) Maya II
- Grade D**
 (66) Class II

* For most current finish and fabric availability please reference surfaces.haworth.com.

ALERT: These materials are current, however they are being considered for future obsolescence due to low volume.

Fabrics

Grade A
 (MM) Twist

Grade B
 (1X) Gauge

Haworth+

For information on the Haworth+ alliance program, including images and product availability, please refer to: [Haworth.com](https://www.haworth.com) > Surface Collection > Haworth+ Library

Customer's Own Material (COM)

For general Customer's Own Material (COM) information including processes and forms, please refer to: [Haworth.com](https://www.haworth.com) > Surface Collection > Resources > COM

For information on approved COM's, please refer to: [Haworth.com](https://www.haworth.com) > Surface Collection > COM Library

Index

Products are listed alphabetically in this index by alpha-numeric prefix/suffix codes.

Product Code	Product Description	Page
EURT-0000-N001CB	Bezel Utility Module27
EURT-0000-N001CW	Bezel Utility Module27
EURT-0000-N001SB	Bezel Utility Module27
EURT-0000-N001SW	Bezel Utility Module27
EURT-0072-1010	Bezel Utility Module27
EURT-0072-1100	Bezel Utility Module27
HOA1-3	Double Booth21
HOAB-2	Single Booth20
HOAC-3	Corner Booth22
HOAD-3	Double Desk18
HOAE-5	Privacy Booth23
HOAP-3	Privacy Desk19
HOAS-2	Single Desk17
HOAW-5	Conference Booth24
HOCH	Accessories – Coat Hook25
HOPD	Hideaway Power Module26
HOUP	Accessories – Pillows25
HOUS	Accessories – Soft Storage25
SODB-2424-P	Sprig Tables – Round16
SODC-1616-P	Sprig Tables – Round16
SON-3	Plume Screens – Plume 311
SON-6	Plume Screens – Plume 611
SON-9	Plume Screens – Plume 911
SOPB-2223	Chick Pouf – Chick Pouf with Back13
SOPN-2223	Chick Pouf – Chick Pouf without Back13
SOPN-2238	Chick Pouf – Large Square - No Back14
SOPN-2252	Chick Pouf – Rectangle - No Back14
SOPN-2265	Chick Pouf – Round - No Back15
SORA-5320-P	Sprig Tables – Rectangle16
SOSR-1-N	Feather Sofa – Feather – Asymmetrical12
SOSS-1-N	Feather Sofa – Feather – Symmetrical12

Product Compatibility and Limited Warranty Policy

Great Expectations

You have them as a Haworth customer and so do we. And because we value our customers, we cover our products with the Haworth North America Product Compatibility and Limited Warranty Policy.

Our Commitment To Product Compatibility – Integrated Product Platforms

As a market leader in the design and manufacture of workspaces that adapt to change, we strive to maintain product compatibility within our various generations of integrated product platforms. This benefits the customer who desires to update or modify their work environment. It also benefits the customer needing to replace a product due to damage or other reasons but which is no longer manufactured or is otherwise unavailable, such as a fabric or finish that is discontinued because of changing market preferences. In both circumstances, we often can provide products with comparable function and performance.

Our Commitment To Product Quality – The Haworth North America Limited Warranty

To ensure customer satisfaction and peace of mind, we stand behind our products with the Haworth North America Limited Warranty. To review the current version of the limited warranty including its terms and conditions, please go to:

www.haworth.com/warranty or contact OneTouch@Haworth.com or 1 877 429 6784.

Warranty Requests or Questions

For questions or service requests pertaining to the Haworth Limited Warranty, please contact your Haworth dealer.

If you are unsure who your dealer is, please contact **OneTouch@Haworth.com or 1 877 429 6784.**

Terms of Sale

The Terms of Sale apply to all products in the North America Price Lists. To review the current version of the North American Terms of Sale, please go to:

www.haworth.com/terms-of-sale or contact OneTouch@Haworth.com or 1 877 429 6784.

HAWORTH

HAWORTH® is a registered trademark of Haworth, Inc.
© Haworth, Inc. All rights reserved. 2025 3.25
haworth.com | 800 344 2600