

Cabana Lounge

GSA Price List – February 2026



This price list is based upon Haworth's December 2025 commercial pricing.

GENERAL SERVICES ADMINISTRATION FEDERAL SUPPLY SERVICE

Authorized Federal Supply Scheduled Price List (Catalog) Office Furniture, Wood Casegoods and Tables
(FSC Group 71, Part I, FSC Classes 7105, 7110, 7125 and 7195)

Contract No: GS-03F-057DA | Contract Period: February 28, 2026 – February 7, 2031 | Business: Large
Contractor: Haworth, Inc. | One Haworth Center | Holland, MI 49423-9576 | 1.616.393.3000





This Haworth North American price book contains US list prices.

Canadian customers can convert the US list price into their Canadian equivalent by going to www.Haworth.com/Canada to find the current Canadian multipliers. These multiplier factors allow you to convert the US list price into a Canadian list price.

HAWORTH, INC.

GENERAL SERVICES ADMINISTRATION

FEDERAL ACQUISITION SERVICES

Authorized Federal Supply Schedule Furniture (FSC Group 71, FSC Classes 7105, 7110, 7125 and 7195)

Contract Number:	GS-03F-057DA
Contract Start Date:	February 28, 2026
Contract End Date:	February 7, 2031
Contractor:	HAWORTH, INC. One Haworth Center Holland, MI 49423-9576 1-616-393-3000 http://www.haworth.com/government
Business Size:	Large

Information for Ordering Activities I-FSS-600

Online access to Haworth's Authorized Federal Supply Schedule contract ordering information, terms and conditions, and up-to-date product and discount listing can be found at GSA Advantage, eLibrary link [here](#).



This Page Intentionally Left Blank

Cabana Lounge Price List

Includes pricing, catalog numbers, finish codes/availability, specification requirements, line art, dimensions, and specification tips for Cabana Lounge.

Individual Lounge

Corner Sofa

Single Seat Sofa

Two-Seat Collaborative Sofa

Chaise Lounge

Tables

Chaise Lounge Retreat

Half-Back Sofa Retreat

Lounge Island

Accessories

Table of Contents

Price List

Statement of Line	7
At-A-Glance	
General Specifications	10
Cabana Lounge	
General Specifications - Seating	11
General Specifications - Tables	12
Individual Lounge	13
Corner Sofa	14
Single Seat Sofa	15
Two-Seat Collaborative Sofa	17
Chaise Lounge	20
Tables	
Square	22
Square Tiered	23
Rectangle	25
Rectangle Tiered	26
Wedge	28
Wedge Tiered	29
Chaise Lounge Retreat	31
Half-Back Sofa Retreat	33
Lounge Island	36
Lounge Island Screen and Ganging Bracket	
Island Screen	38
Lounge Island Screen Ganging Bracket	
Island Screen Ganging Bracket	38
Accessories	
Ganging Bracket	39
Shelf	40
Coat Hook	40
Connector Screen	41
Shelf with Monitor Mount	41
Bezel Utility Module	42
Data Bezel	42
Resources	
Surface Materials	
Finish/Color Legend	44
Fabrics/Color Legend	45
COM Yardage Requirements	46
Index	47

Statement of Line

Individual Lounge

Page 13

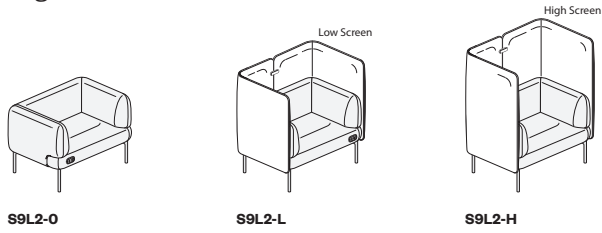

Corner Sofa

Page 14

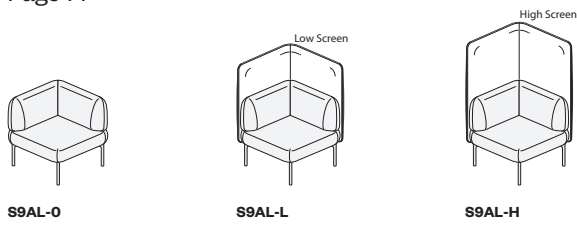

Single Seat Sofa

Page 15-16



Two-Seat Collaborative Sofa

Pages 17-19

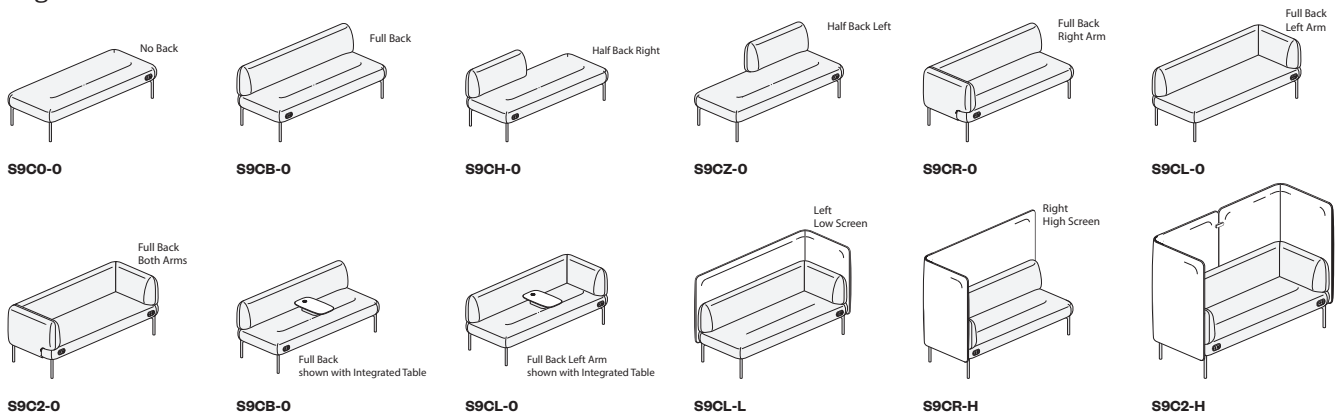

Chaise Lounge

Page 20-21

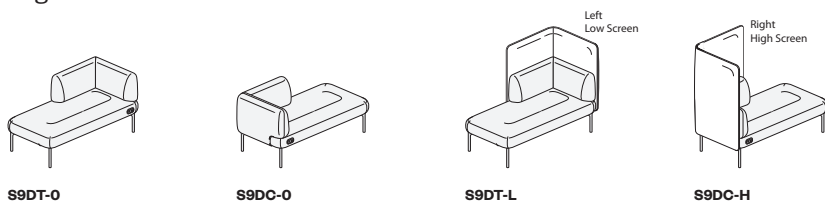

Statement of Line

Tables

Page 22-30

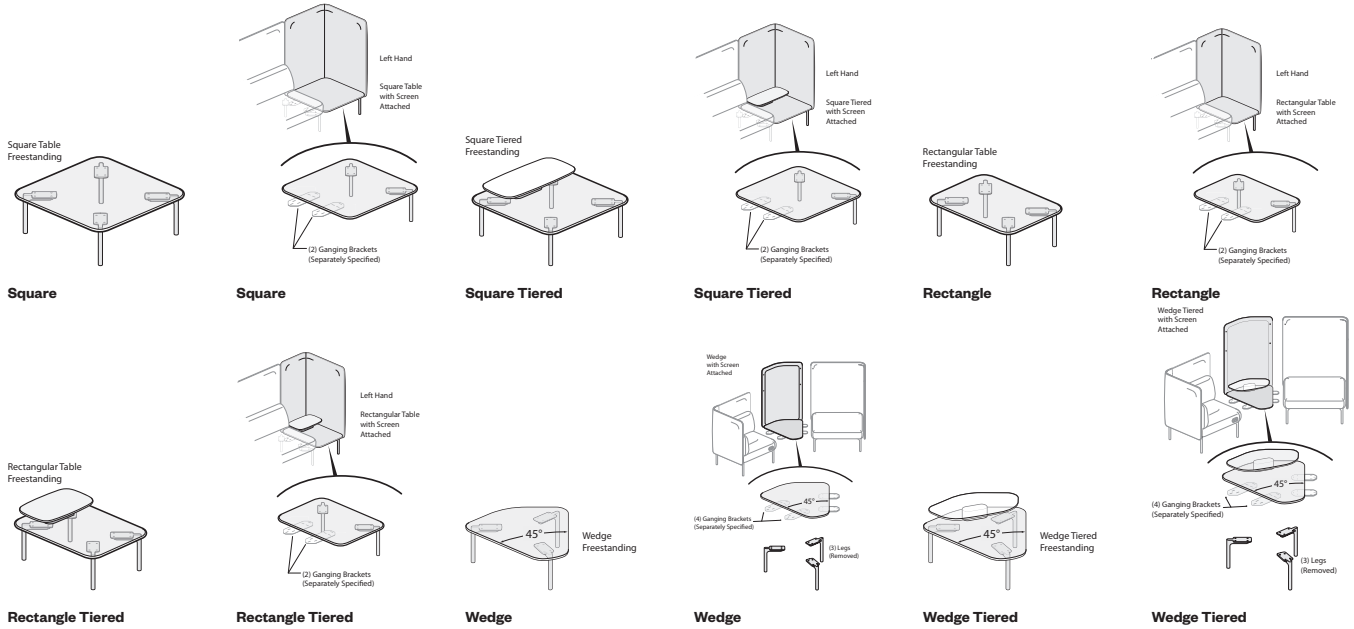

Chaise Lounge Retreat

Page 31-32

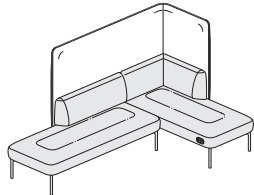

S9EL

Half-Back Sofa Retreat

Page 33-35

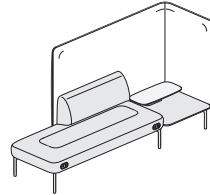

S9F

Lounge Island

Pages 36-38

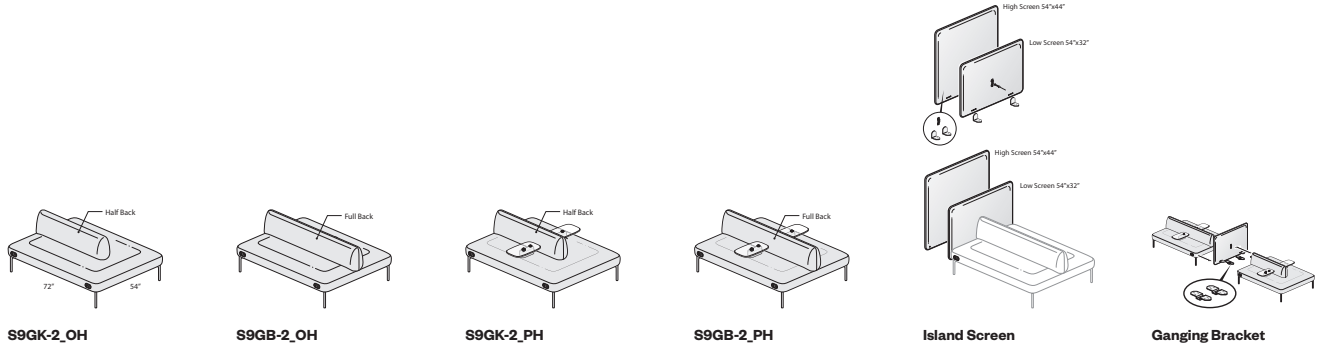

Statement of Line

Accessories

pages 39-41

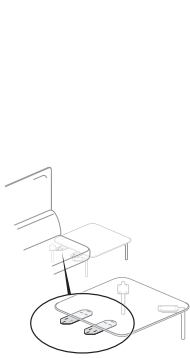

Ganging Bracket

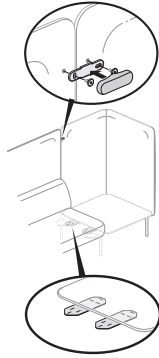

Ganging Kit

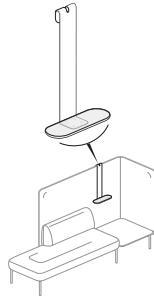

Shelf

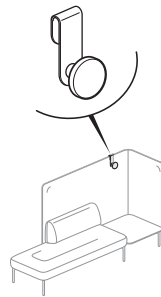

Coat Hook

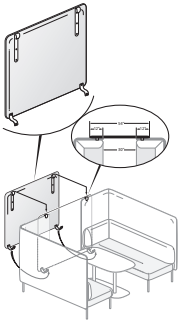

Connector Screen

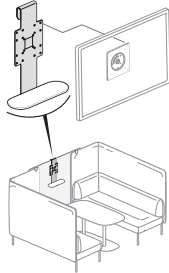

Shelf with Monitor Mount

Bezel Utility Module

page 42

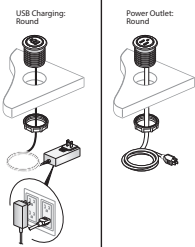

Bezel Utility Module

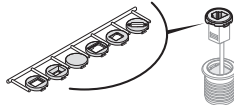

Data Bezel

At-A-Glance

General Specifications

Designer	Patricia Urquiola - Studio Urquiola
Cabana Lounge	Cabana Lounge is a light-scale sofa system designed to deliver optimal user performance, comfort and design to create unique destination spaces in the office.
Awards	Best of Neocon Gold Award 2019 - Lounge Furniture Collection HiP Award - Workplace: High-Back Seating

- Products shown:
- Two-Seat Collaborative Sofa, Full Back, Right and Left Arms, High Screen
 - Two-Seat Collaborative Sofa, Full Back, Left Arm, Embedded Power - Left, High Screen
 - Ganging Kit
 - Single Seat Sofa, No Back
 - (2) Pip Personal Laptop Table
 - Openest Pillow

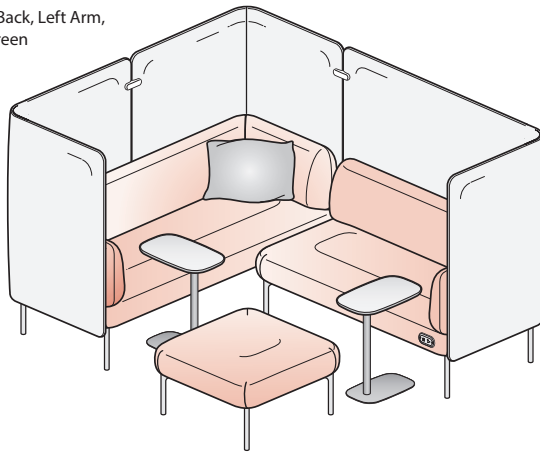

- Products Shown:
- Chaise Lounge Retreat, Embedded Power - Left, High Screen
 - Single Seat Sofa, No Back
 - Pip Personal Laptop Table
 - Openest Pillow

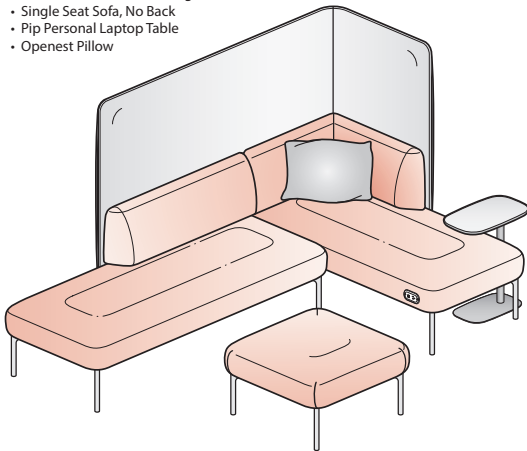

- Products Shown:
- (2) Single Seat Sofa, Full Back, Right Arm, High Screen
 - (2) Ganging Brackets
 - Tiered Table - Rectangular
 - (2) Bezel Utility Modules
 - Single Seat Sofa, No Back
 - Coat Hook
 - Pip Personal Laptop Table

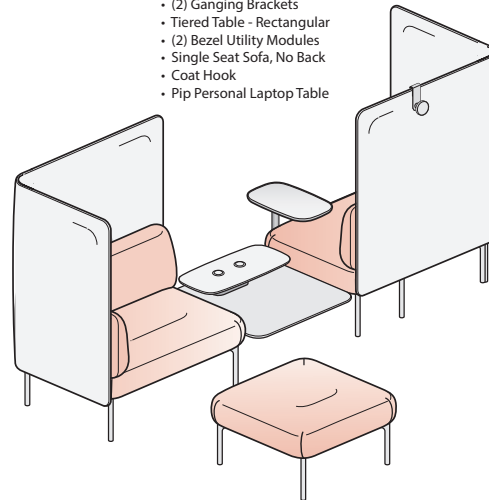

- Products Shown:
- Two-Seat Collaborative Sofa, Full Back, Right Arm, Integrated Table, Low Screen
 - Two-Seat Collaborative Sofa, Full Back, Left Arm, Integrated Table, Low Screen
 - Tiered Table - Wedge, Low Screen
 - (2) Ganging Kits
 - (6) Bezel Utility Modules

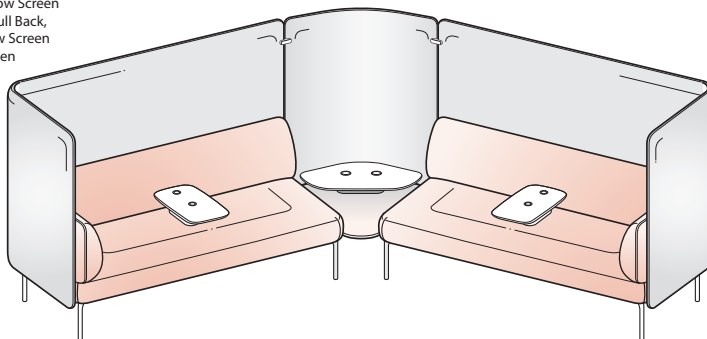

Cabana Lounge

General Specifications - Seating

Catalog Logic

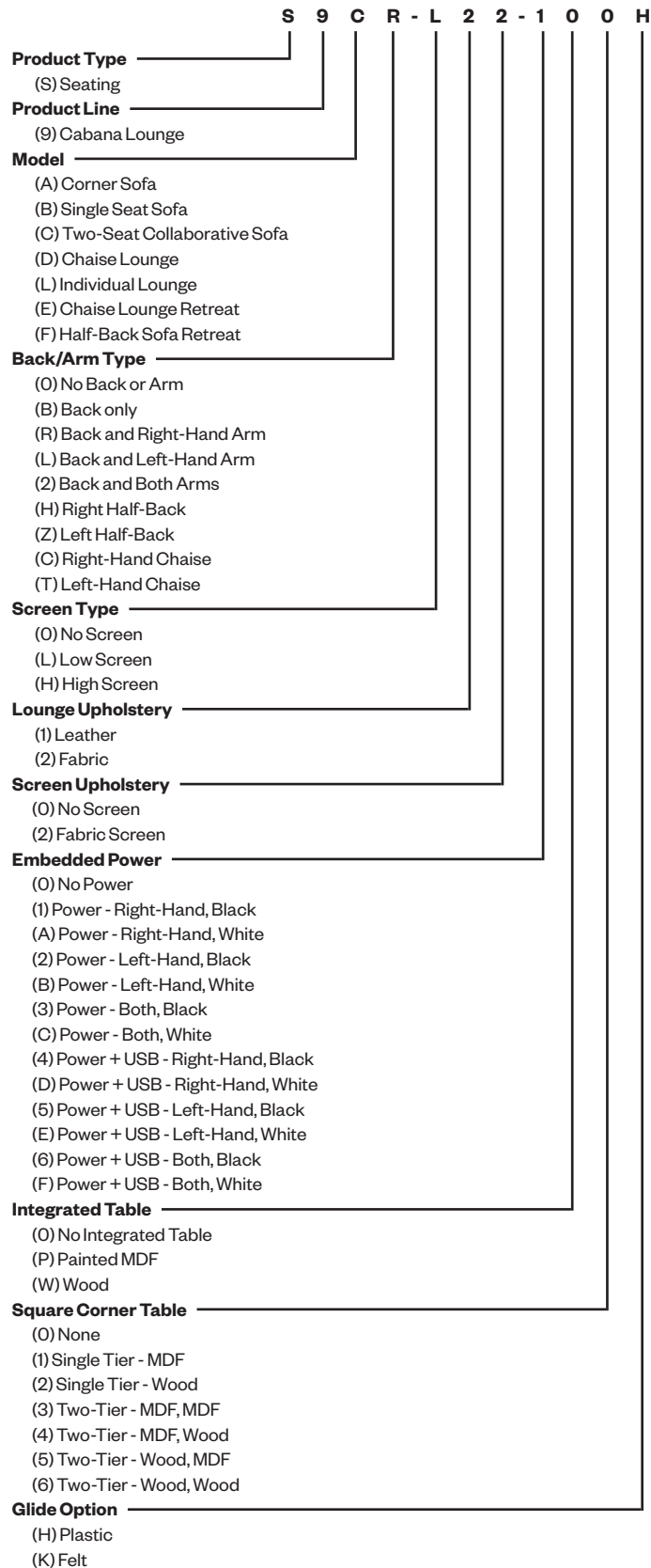

Cabana Lounge

General Specifications - Tables

Catalog Logic

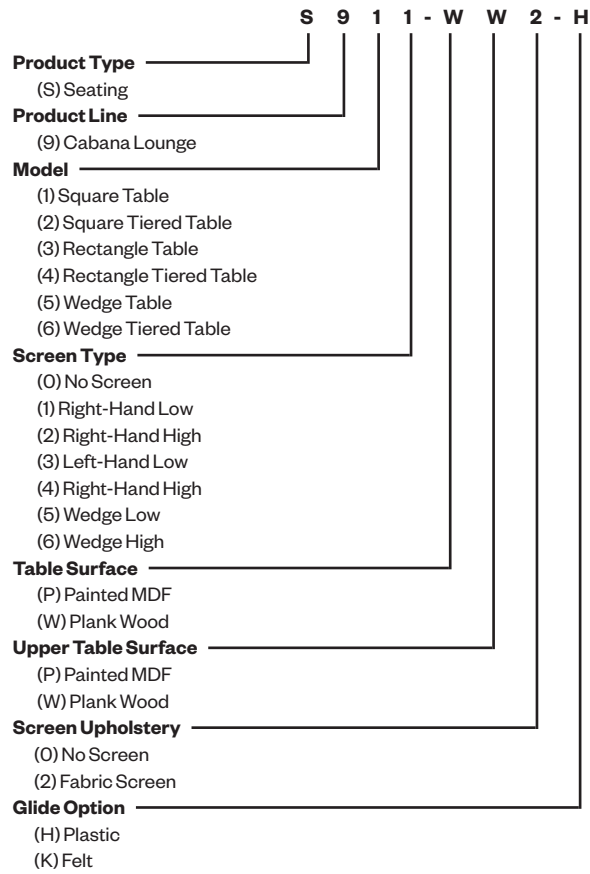

Individual Lounge

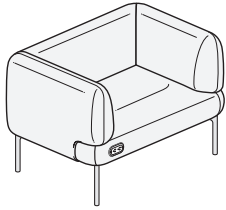

S9L2-0

Low Screen

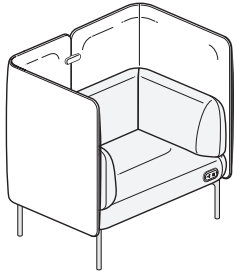

S9L2-L

High Screen

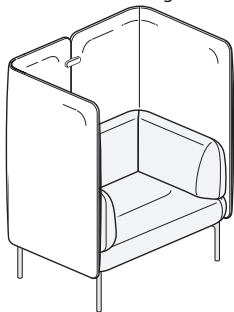

S9L2-H
Class CB

Features

- Includes: Individual lounge chair with back and right and left hand arms on four legs.
- Optional Low or High Screen available. Two-piece screen will surround both sides and back. Screens will be connected with Screen Alignment Clip.
- Embedded Power is available in two options:
 - Power - Two Power Receptacles (NEMA-5-15R) per location
 - Power + USB - One Power Receptacle (NEMA-5-15R) and one Dual USB A-C (20W shared between A and C).
- Power is embedded on seat front on left or right-hand side.
- Legs - painted cast aluminum.
- Glides - Black plastic or felt with 0.5"(13mm) leveling adjustment.
- COM yardage/COL square footage: (COL N/A on screens)
Seat/back/arms: 5.00/82.5
Screen Low: 6.25/N/A High: 6.5/N/A

Specification Tips

- Individual Lounge is not designed to be ganged to other Cabana products due to interference with back, arms and screen.
- Lounge and screen fabric are applied railroaded.
- Linear or patterned fabric not recommended due to the way material is applied.
- Seat and Screen may be specified with different materials. To specify, select seat material grade. Next, select screen material and add appropriate upcharge (see chart).
- When ordering with screens please note the change in Number:
 - No Screen S9L2-0
 - Low Screen S9L2-L
 - High Screen S9L2-H
- Embedded Power is factory installed and cannot be field installed. Power type can be field modified with service parts.
- For use with 120 volt 60 hertz electrical system only.**
- Place powered seating within 4"(1219mm) of power source. Power components ship with 10'(3048mm) cord routed to an opening at rear of seating unit.
- The following separately specified items are designed to work with Cabana screens. It is recommended to use these items on High Screens or placed over a table to prevent interference with user.
 - Shelf S9SH-0
 - Coat Hook HOCH-0000
- See Specification Guide for Application Details.
- Powered applications may require approval of local authority having jurisdiction (AHJ); ensure compliance before placing orders and installing.

Dimensions

Height:	Depth:	Width:
No screen - 30.5"(775mm)	No screen - 30"(762mm)	No Screen - 42"(1067mm)
Low Screen - 42"(1067mm)	With Screen - 32"(813mm)	With Screen - 46"(1168mm)
High Screen - 54"(1372mm)	*SD: 21.125"(537mm)	SW: 24"(610mm)
*SH: 17.3"(439mm)		

*Measurements taken with the BIFMA chair measuring device.

To Order, Specify:

1) Product number, including:

1 Seat Upholstery Type:

- 1 Leather
- 2 Fabric

2 Power Option:

- 0 None

Power

- 1 Right Power - Black (add **\$357.53** list)

- A Right Power - White (add **\$357.53** list)

- 2 Left Power - Black (add **\$357.53** list)

- B Left Power - White (add **\$357.53** list)

Power + USB

- 4 Right Power + USB - Black (add **\$450.79** list)

- D Right Power + USB - White (add **\$450.79** list)

- 5 Left Power + USB - Black (add **\$450.79** list)

- E Left Power + USB - White (add **\$450.79** list)

3 Glide Option:

- H Plastic Glide
- K Felt Glide

2) Seat, back and arm material.

3) Screen material (if applicable).
See chart (below) for upcharge.

4) Trim color.

Seat, Back & Arms Fabric

Description	Number			Seat, Back & Arms Fabric								Leather	
	1	2	3	A	B	C	D	E	F	G	H	A	B
No Screen	S9L2-0	0-	00	\$3774.24	\$4108.47	\$4287.20	\$4644.74	\$4893.46	\$6043.75	\$6727.73	\$7963.53	\$6805.43	\$8056.79
Low Screen ¹	S9L2-L	2-	00	5790.38	6124.61	6303.34	6660.88	6909.60	8059.89	8743.87	9979.67	8821.57	10072.93
High Screen ¹	S9L2-H	2-	00	5790.38	6124.61	6303.34	6660.88	6909.60	8059.89	8743.87	9979.67	8821.57	10072.93

¹Pricing shown for Low and High Screen reflects screen Grade A pricing. Reference chart for upcharge amounts for higher grade pricing.

Description	A	B	C	D	E	F	G	H
Low Screen (2) 30" x 21"	N/A	\$466.34	\$715.05	\$1212.48	\$1570.01	\$3171.11	\$4134.87	\$5860.32
High Screen (2) 30" x 21"	N/A	\$466.34	\$715.05	\$1212.48	\$1570.01	\$3171.11	\$4134.87	\$5860.32

The following option requires modification of the product number.

Stain repellent

(not applicable to screens)

To specify, add **P** to the end of the product number (add **\$155.57** list); **Example:** S9L2-020-100HP

Single Seat Sofa

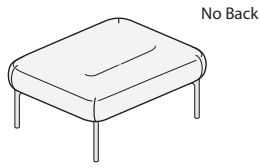

No Back

S9B0-0

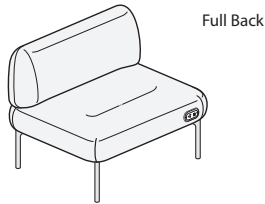

Full Back

S9BB-0

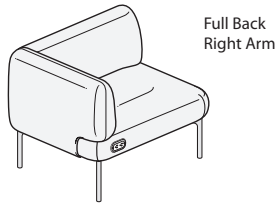

Full Back
Right Arm

S9BR-0



Full Back
Left Arm

S9BL-0

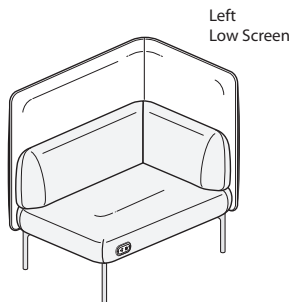

Left
Low Screen

S9BL-L

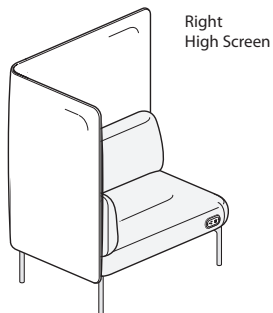

Right
High Screen

S9BR-H
Class CB

Features

- Includes: Single seat sofa with optional back and right or left arm on four legs.
- Optional Low or High Screen available. Screen attaches to arm and back. Unit with right arm will have a right-hand 30"(762mm)D x 36"(914mm)W screen.
- Embedded Power available in two options:
 - Power - Two Power Receptacles (NEMA-5-15R) per location
 - Power + USB - One Power Receptacle (NEMA-5-15R) and one Dual USB A-C (20W shared between A and C).
- Power is embedded on seat front on left or right-hand side.
- Power housing available in supplier Black or White with 10'(3048mm) black cord.
- Legs - painted cast aluminum.
- Glides - Black plastic or felt with 0.5"(13mm) leveling adjustment.
- COM yardage/COL square footage: (COL N/A on screens)
 - Seat only: 1.75/28.5
 - Seat/back: 3.0/50.0
 - Seat/back/arm: 3.75/63.5
 - Screen Low: 4.25/N/A High: 4.5/N/A

Specification Tips

- Gangs on open seat depth to separately specified Cabana seating or tables with or without a screen. Use separately specified Ganging Bracket or Ganging Kit.
- Cannot gang on arm, back or screen locations due to interference. For options see Specification Guide.
- Sofa and screen fabric are applied railroaded.
- Linear or patterned fabric not recommended due to the way material is applied.
- Seat and Screen may be specified with different materials. To specify, select seat material grade. Next, select screen material and add appropriate upcharge (see chart).
- When ordering with screens please note the change in Number:
 - No Screen S9B_-0
 - Low Screen S9B_-L
 - High Screen S9B_-H
- Embedded Power is factory installed and cannot be field installed. Power type can be field modified with service parts.
- For use with 120 volt 60 hertz electrical system only.**
- Place powered seating within 4'(1219mm) of power source. Power components ship with 10'(3048mm) cord routed to a corresponding opening at rear of seating unit.
- The following separately specified items are designed to work with Cabana screens. It is recommended to use these items on High Screens or placed over a table to prevent interference with user.
 - Shelf S9SH-0
 - Coat Hook HOCH-0000
- See Specification Guide for Application Details.
- Powered applications may require approval of local authority having jurisdiction (AHJ); ensure compliance before placing orders or installing.

Dimensions

Height:	Depth:	Width:
No screen - 30.5"(775mm)	No screen - 30"(762mm)	36"(914mm)
Low Screen - 42"(1067mm)	With Screen - 32"(813mm)	SW:
High Screen - 54"(1372mm)	*SD:	With Arm - 27"(686mm)
*SH: 17.3"(439mm)	With Back - 21.25"(537mm)	Without Arm - 36"(914mm)
	Without Back - 30"(762mm)	

*Measurements taken with the BIFMA chair measuring device.

To Order, Specify:

1) Product number, including:

1 Seat Upholstery Type:

- 1 Leather
- 2 Fabric

2 Power Option:

- 0 None

Power

- 1 Right Power - Black (add **\$357.53** list)

- A Right Power - White (add **\$357.53** list)

- 2 Left Power - Black (add **\$357.53** list)

- B Left Power - White (add **\$357.53** list)

Power + USB

- 4 Right Power + USB - Black (add **\$450.79** list)

- D Right Power + USB - White (add **\$450.79** list)

- 5 Left Power + USB - Black (add **\$450.79** list)

- E Left Power + USB - White (add **\$450.79** list)

3 Glide Option:

- H Plastic Glide
- K Felt Glide

2) Seat, back and arm material.

3) Screen material (if applicable).
See chart (next page) for upcharge.

4) Leg color.

Two-Seat Collaborative Sofa



Features

- Includes: Two-seat sofa on four legs. Sofa can be specified with a half-back, full-back, arms, low or high screens, integrated table and embedded power.
- Optional Low or High Screen available on sofa with full back and right or left-hand arm or both right and left-hand arm. Screen attaches to arm and back. Unit with right arm will have a 30"(762mm)D x 72"(1829mm)W right-hand screen. Sofa with two arms will have two 30"(762mm)D x 36"(914mm)W screens connected with a screen alignment clip.
- Embedded Power available in two options:
 - Power - Two Power Receptacles (NEMA-5-15R) per location
 - Power + USB - One Power Receptacle (NEMA-5-15R) and one Dual USB A-C (20W shared between A and C).
- Power is embedded on seat front on left or right-hand side, or both. When ordering power on both sides the power option will be the same.
- Power housing available in supplier Black or White and has a 10'(3048mm) black cord.
- Integrated table option available on Two-Seat Collaborative Sofas with half-back or full-back.
- Integrated table is 0.75"(19mm) thick and 20"(508mm)D x 11"(279mm)W mounted on a 3.5"(89mm)H stanchion.
- Legs are painted cast aluminum.
- Glides - Black plastic or felt with 0.5"(13mm) leveling adjustment.
- COM yardage/COL square footage:
 - Seat only: 2.75/46.5
 - Seat/half-back: 4.0/70
 - Seat/full-back: 5.0/86
 - Seat/full-back/one arm: 5.75/100
 - Seat/full-back/two arms: 6.5/112.5
 - Screen 30" x 72" Low: 6.25/N/A High: 6.5/N/A
 - Screen 30" x 36" Low: 4.0/N/A High: 4.25/N/A (per screen - there are two screens on this unit.)

Specification Tips

- Gangs on open seat depth with separately specified Cabana seating or tables with or without a screen. Use separately specified Ganging Bracket or Ganging Kit.
- Cannot gang on arm, back or screen locations due to interference. For options see Specification Guide.
- Sofa and screen fabric are applied railroaded.
- Linear or patterned fabric not recommended due to the way material is applied.
- Seat and Screen may be specified with different materials. To specify, select seat material grade. Next, select screen material and add appropriate upcharge (see chart).
- When ordering with screens please note the change in Number:
 - No Screen S9C_-0
 - Low Screen S9C_-L
 - High Screen S9C_-H
- Embedded Power is factory installed and cannot be field installed. Power type can be field modified with service parts.
- **For use with 120 volt 60 hertz electrical system only.**
- Place powered seating within 4"(1219mm) of power source. Power components each have a 10'(3048mm) cord routed to a corresponding opening at rear of seating unit.
- Integrated Table is factory installed. The table position is fixed and cannot be field modified.
- The Integrated Table is designed to work with separately specified, field installed, Bezel Utility Module EURT-00_ _ . Table stanchion allows cord management through the seat. Bezel Utility Modules ship standard with 6'(1829mm) or 12'(3658mm) cord lengths.
- The following separately specified items are designed to work with Cabana screens. It is recommended to use these items on High Screens or placed over a table to prevent interference with user.
 - Shelf S9SH-0
 - Coat Hook HOCH-0000
- See Specification Guide for Application Details.
- Powered applications may require approval of local authority having jurisdiction (AHJ); ensure compliance before placing orders or installing.

Dimensions

Height:	Depth:	Width:
No screen - 30.5"(775mm)	No screen - 30"(762mm)	72"(1829mm)
Low Screen - 42"(1067mm)	With Screen - 32"(813mm)	SW:
High Screen - 54"(1372mm)	*SD:	With One Arm - 63"(1600mm)
*SH: 17.3"(439mm)	With Back - 21.125"(537mm)	With Two Arms - 54"(1372mm)
	Without Back - 30"(762mm)	Without Arms - 72"(1829mm)

*Measurements taken with the BIFMA chair measuring device.

To Order, Specify:

1) Product number, including:

1 Seat Upholstery Type:

- 1 Leather
- 2 Fabric

2 Power Option:

- 0 None

Power

- 1 Right Power - Black (add **\$357.53** list)

- A Right Power - White (add **\$357.53** list)

- 2 Left Power - Black (add **\$357.53** list)

- B Left Power - White (add **\$357.53** list)

- 3 Right + Left Power - Black (add **\$715.05** list)

- C Right + Left Power - White (add **\$715.05** list)

Power + USB

- 4 Right Power + USB - Black (add **\$450.79** list)

- D Right Power + USB - White (add **\$450.79** list)

- 5 Left Power + USB - Black (add **\$450.79** list)

- E Left Power + USB - White (add **\$450.79** list)

- 6 Right + Left Power + USB - Black (add **\$901.59** list)

- F Right + Left Power + USB - White (add **\$901.59** list)

3 Glide Option:

- H Plastic Glide
- K Felt Glide

2) Seat, back and arm material.

3) Screen material (if applicable). See chart (page 19) for upcharge.

4) Trim color.

5) Table finish/color (if applicable).

Two-Seat Collaborative Sofa

Description	Number			Seat, Back & Arms Fabric								Leather	
	①	②	③	A	B	C	D	E	F	G	H	A	B
No Screen - No Integrated Table													
No Back	S9C0-0	0-	00	\$ 3267.48	\$ 3430.71	\$ 3523.96	\$ 3702.75	\$ 3827.08	\$ 4402.25	\$ 4744.22	\$ 5366.00	\$ 4860.82	\$ 5490.37
Half Back - Right	S9CH-0	0-	00	4310.53	4559.25	4699.14	4963.39	5149.95	6012.68	6525.64	7450.53	6634.45	7567.15
Half Back - Left	S9CZ-0	0-	00	4310.53	4559.25	4699.14	4963.39	5149.95	6012.68	6525.64	7450.53	6634.45	7567.15
Full Back	S9CB-0	0-	00	4658.73	4992.96	5171.69	5529.23	5777.95	6928.24	7627.76	8848.02	7682.16	8933.49
Full Back/Right Arm	S9CR-0	0-	00	5202.79	5599.18	5816.81	6244.26	6547.39	7923.09	8746.94	10231.48	8809.14	10309.20
Full Back/Left Arm	S9CL-0	0-	00	5202.79	5599.18	5816.81	6244.26	6547.39	7923.09	8746.94	10231.48	8809.14	10309.20
Full Back/Both Arms	S9C2-0	0-	00	5746.85	6213.19	6469.69	6967.11	7316.86	8917.96	9881.70	11607.15	10099.34	11910.29
No Screen - Integrated Table Painted MDF													
Half Back - Right	S9CH-0	0-	PO	\$ 4955.62	\$ 5204.34	\$ 5344.23	\$ 5608.48	\$ 5795.04	\$ 6657.77	\$ 7170.73	\$ 8095.62	\$ 7279.54	\$ 8212.24
Half Back - Left	S9CZ-0	0-	PO	4955.62	5204.34	5344.23	5608.48	5795.04	6657.77	7170.73	8095.62	7279.54	8212.24
Full Back	S9CB-0	0-	PO	5303.82	5638.05	5816.78	6174.32	6423.04	7573.33	8272.85	9493.11	8327.25	9578.58
Full Back/Right Arm	S9CR-0	0-	PO	5847.88	6244.27	6461.90	6889.35	7192.48	8568.18	9392.03	10876.57	9454.23	10954.29
Full Back/Left Arm	S9CL-0	0-	PO	5847.88	6244.27	6461.90	6889.35	7192.48	8568.18	9392.03	10876.57	9454.23	10954.29
Full Back/Both Arms	S9C2-0	0-	PO	6391.94	6858.28	7114.78	7612.20	7961.95	9563.05	10526.79	12252.24	10744.43	12555.38
No Screen - Integrated Table Plank White Oak													
Half Back - Right	S9CH-0	0-	WO	\$ 6479.02	\$ 6727.74	\$ 6867.63	\$ 7131.88	\$ 7318.44	\$ 8181.17	\$ 8694.13	\$ 9619.02	\$ 8802.94	\$ 9735.64
Half Back - Left	S9CZ-0	0-	WO	6479.02	6727.74	6867.63	7131.88	7318.44	8181.17	8694.13	9619.02	8802.94	9735.64
Full Back	S9CB-0	0-	WO	6827.22	7161.45	7340.18	7697.72	7946.44	9096.73	9796.25	11016.51	9850.65	11019.98
Full Back/Right Arm	S9CR-0	0-	WO	7371.28	7767.67	7985.30	8412.75	8715.88	10091.58	10915.43	12399.97	10977.63	12477.69
Full Back/Left Arm	S9CL-0	0-	WO	7371.28	7767.67	7985.30	8412.75	8715.88	10091.58	10915.43	12399.97	10977.63	12477.69
Full Back/Both Arms	S9C2-0	0-	WO	7915.34	8381.68	8638.18	9135.60	9485.35	11086.45	12050.19	13775.64	12267.83	14078.78
No Screen - Integrated Table Plank Walnut													
Half Back - Right	S9CH-0	0-	WO	\$ 6611.12	\$ 6859.84	\$ 6999.73	\$ 7263.98	\$ 7450.54	\$ 8313.27	\$ 8826.23	\$ 9751.12	\$ 8935.04	\$ 9867.74
Half Back - Left	S9CZ-0	0-	WO	6611.12	6859.84	6999.73	7263.98	7450.54	8313.27	8826.23	9751.12	8935.04	9867.74
Full Back	S9CB-0	0-	WO	6959.32	7293.55	7472.28	7829.82	8078.54	9228.83	9928.35	11148.61	9982.75	11234.08
Full Back/Right Arm	S9CR-0	0-	WO	7503.38	7899.77	8117.40	8544.85	8847.98	10223.68	11047.53	12532.07	11109.73	12609.79
Full Back/Left Arm	S9CL-0	0-	WO	7503.38	7899.77	8117.40	8544.85	8847.98	10223.68	11047.53	12532.07	11109.73	12609.79
Full Back/Both Arms	S9C2-0	0-	WO	8047.44	8513.78	8770.28	9267.70	9617.45	11218.55	12182.29	13907.74	12399.93	14210.88
Low Screen¹ - No Integrated Table													
Full Back/Right Arm	S9CR-L	2-	00	\$ 7338.62	\$ 7735.01	\$ 7952.64	\$ 8380.09	\$ 8683.22	\$10058.92	\$10882.77	\$ 12367.31	\$10944.97	\$12445.03
Full Back/Left Arm	S9CL-L	2-	00	7338.62	7735.01	7952.64	8380.09	8683.22	10058.92	10882.77	12367.31	10944.97	12445.03
Full Back/Both Arms	S9C2-L	2-	00	7994.61	8460.95	8717.45	9214.87	9564.62	11165.72	12129.46	13854.91	12347.10	14158.05
Low Screen¹ - Integrated Table Painted MDF													
Full Back/Right Arm	S9CR-L	2-	PO	\$ 7983.71	\$ 8380.10	\$ 8597.73	\$ 9025.18	\$ 9328.31	\$10704.01	\$ 11527.86	\$ 13012.40	\$ 11590.06	\$13090.12
Full Back/Left Arm	S9CL-L	2-	PO	7983.71	8380.10	8597.73	9025.18	9328.31	10704.01	11527.86	13012.40	11590.06	13090.12
Full Back/Both Arms	S9C2-L	2-	PO	8639.70	9106.04	9362.54	9859.96	10209.71	11810.81	12774.55	14500.00	12992.19	14803.14
Low Screen¹ - Integrated Table Plank White Oak													
Full Back/Right Arm	S9CR-L	2-	WO	\$ 9507.11	\$ 9903.50	\$ 10211.13	\$10548.58	\$ 10851.71	\$ 12227.41	\$ 13051.26	\$14535.80	\$ 13113.46	\$14613.52
Full Back/Left Arm	S9CL-L	2-	WO	9507.11	9903.50	10211.13	10548.58	10851.71	12227.41	13051.26	14535.80	13113.46	14613.52
Full Back/Both Arms	S9C2-L	2-	WO	10163.10	10629.44	10885.94	11383.36	11733.11	13334.21	14297.95	16023.40	14515.59	16326.54
Low Screen¹ - Integrated Table Plank Walnut													
Full Back/Right Arm	S9CR-L	2-	WO	\$ 9639.21	\$10035.60	\$10253.23	\$10680.68	\$10983.81	\$ 12359.51	\$ 13183.36	\$14667.90	\$ 13245.56	\$14745.62
Full Back/Left Arm	S9CL-L	2-	WO	9639.21	10035.60	10253.23	10680.68	10983.81	12359.51	13183.36	14667.90	13245.56	14745.62
Full Back/Both Arms	S9C2-L	2-	WO	10295.20	10761.54	11018.04	11515.46	11865.21	13466.31	14430.05	16155.50	14647.69	16458.64
High Screen¹ - No Integrated Table													
Full Back/Right Arm	S9CR-H	2-	00	\$ 7338.62	\$ 7735.01	\$ 7952.64	\$ 8380.09	\$ 8683.22	\$10058.92	\$10882.77	\$ 12367.31	\$10944.97	\$12445.03
Full Back/Left Arm	S9CL-H	2-	00	7338.62	7735.01	7952.64	8380.09	8683.22	10058.92	10882.77	12367.31	10944.97	12445.03
Full Back/Both Arms	S9C2-H	2-	00	7994.61	8460.95	8717.45	9214.87	9564.62	11165.72	12129.46	13854.91	12347.10	14158.05

¹Pricing shown for Low and High Screen reflects screen Grade A pricing. Reference chart for upcharge amounts for higher grade pricing.

Two-Seat Collaborative Sofa

Description	Number			Seat, Back & Arms Fabric								Leather	
	①	②	③	A	B	C	D	E	F	G	H	A	B
High Screen¹ - Integrated Table Painted MDF													
Full Back/Right Arm	S9CR-H	2-	PO	\$ 7983.71	\$ 8380.10	\$ 8597.73	\$ 9025.18	\$ 9328.31	\$10704.01	\$ 11527.86	\$ 13012.40	\$ 11590.06	\$13090.12
Full Back/Left Arm	S9CL-H	2-	PO	7983.71	8380.10	8597.73	9025.18	9328.31	10704.01	11527.86	13012.40	11590.06	13090.12
Full Back/Both Arms	S9C2-H	2-	PO	8639.70	9106.04	9362.54	9859.96	10209.71	11810.81	12774.55	14500.00	12992.19	14803.14
High Screen¹ - Integrated Table Plank White Oak													
Full Back/Right Arm	S9CR-H	2-	WO	\$ 9507.11	\$ 9903.50	\$ 10121.13	\$10548.58	\$ 10851.71	\$ 12227.41	\$ 13051.26	\$ 14535.80	\$ 13113.46	\$ 14613.52
Full Back/Left Arm	S9CL-H	2-	WO	9507.11	9903.50	10121.13	10548.58	10851.71	12227.41	13051.26	14535.80	13113.46	14613.52
Full Back/Both Arms	S9C2-H	2-	WO	10163.10	10629.44	10885.94	11383.36	11733.11	13334.21	14297.95	16023.40	14515.59	16326.54
High Screen¹ - Integrated Table Plank Walnut													
Full Back/Right Arm	S9CR-H	2-	WO	\$ 9639.21	\$10035.60	\$10253.23	\$10680.68	\$10983.81	\$12359.51	\$ 13183.36	\$ 14667.90	\$13245.56	\$ 14745.62
Full Back/Left Arm	S9CL-H	2-	WO	9639.21	10035.60	10253.23	10680.68	10983.81	12359.51	13183.36	14667.90	13245.56	14745.62
Full Back/Both Arms	S9C2-H	2-	WO	10295.20	10761.54	11018.04	11515.46	11865.21	13466.31	14430.05	16155.50	14647.69	16458.64

¹Pricing shown for Low and High Screen reflects screen Grade A pricing. Reference chart for upcharge amounts for higher grade pricing.

Description	A	B	C	D	E	F	G	H
Low Screen 30" x 72"	N/A	\$466.34	\$722.84	\$1220.26	\$1570.01	\$ 3171.11	\$4134.87	\$ 5751.51
Low Screen (2) 30" x 36"	N/A	\$528.53	\$823.87	\$1399.01	\$1787.63	\$3621.89	\$4725.56	\$6699.72
High Screen 30" x 72"	N/A	\$466.34	\$722.84	\$1220.26	\$1570.01	\$ 3171.11	\$4134.87	\$ 5751.51
High Screen (2) 30" x 36"	N/A	\$528.53	\$823.87	\$1399.01	\$1787.63	\$3621.89	\$4725.56	\$6699.72

The following option requires modification of the product number.

- Stain repellent (not applicable to screens) To specify, add **P** to the end of the product number (Seat only add **\$77.72** list, Seat/half-back add **\$116.59** list, Seat/full-back add **\$155.45** list, Seat/back/one arm add **\$186.53** list, Seat/back/two arms add **\$217.62** list);
- Example:** S9CR-020-OWOHP

Chaise Lounge

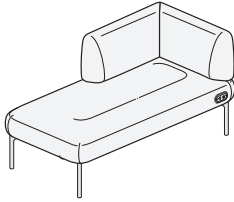

S9DT-0

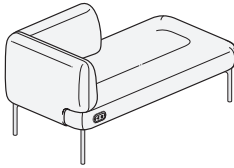

S9DC-0

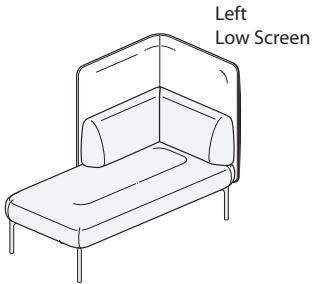

S9DT-L

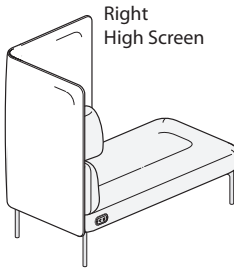

S9DC-H
Class CB

Features

- Includes: Chaise sofa with right or left back and arm and four legs.
- Optional Low or High Screen available. Screen attaches to arm and back. Unit with right arm and back will have a right-hand 30"(762mm)D x 30"(762mm)W screen.
- Embedded Power available in two options:
 - Power - Two Power Receptacles (NEMA-5-15R) per location
 - Power + USB - One Power Receptacle (NEMA-5-15R) and one Dual USB A-C (20W shared between A and C).
- Power is embedded on seat front on left or right-hand side, or both. When ordering power on both sides the power option will be the same.
- Power housing available in supplier Black or White with 10'(3048mm) black cord.
- Legs - painted cast aluminum.
- Glides - Black plastic or felt with 0.5"(13mm) leveling adjustment.
- COM yardage/COL square footage:
 - Chaise: 4.25/72.25
 - Screen Low: 3.75/N/A High: 4.0/N/A

Specification Tips

- Gangs on open width end with separately specified Cabana seating or tables with or without a screen. Use separately specified Ganging Bracket or Ganging Kit.
- Cannot gang on arm, back or screen locations due to interference. For options see Specification Guide.
- Chaise and screen fabric are applied railroaded.
- Linear or patterned fabric not recommended due to the way material is applied.
- Seat and Screen may be specified with different materials. To specify, select seat material grade. Next, select screen material and add appropriate upcharge.(see chart).
- When ordering with screens please note the change in Number:
 - No Screen S9D_-0
 - Low Screen S9D_-L
 - High Screen S9D_-H
- Embedded Power is factory installed and cannot be field installed. Power type can be field modified with service parts.
- For use with 120 volt 60 hertz electrical system only.**
- Place powered seating within 4'(1219mm) of power source. Power components each have a 10'(3048mm) cord routed to a corresponding opening at rear of seating unit.
- The following separately specified items are designed to work with Cabana screens. It is recommended to use these items on High Screens or placed over a table to prevent interference with user.
 - Shelf S9SH-0
 - Coat Hook HOCH-0000
- See Specification Guide for Application Details.
- Powered applications may require approval of local authority having jurisdiction (AHJ); ensure compliance before placing orders or installing.

Dimensions

Height:	Depth:	Width:
No screen - 30.5"(775mm)	No screen - 30"(762mm)	60"(1524mm)
Low Screen - 42"(1067mm)	With Screen - 32"(813mm)	SW: 51"(1295mm)
High Screen - 54"(1372mm)	*SD: 21.125"(537mm)-	
*SH: 17.3"(439mm)	30"(762mm)	

*Measurements taken with the BIFMA chair measuring device.

To Order, Specify:

1) Product number, including:

1 Seat Upholstery Type:

- 1 Leather
- 2 Fabric

2 Power Option:

- 0 None

Power

- 1 Right Power - Black (add **\$357.53** list)

- A Right Power - White (add **\$357.53** list)

- 2 Left Power - Black (add **\$357.53** list)

- B Left Power - White (add **\$357.53** list)

- 3 Right + Left Power - Black (add **\$715.05** list)

- C Right + Left Power - White (add **\$715.05** list)

Power + USB

- 4 Right Power + USB - Black (add **\$450.79** list)

- D Right Power + USB - White (add **\$450.79** list)

- 5 Left Power + USB - Black (add **\$450.79** list)

- E Left Power + USB - White (add **\$450.79** list)

- 6 Right + Left Power + USB - Black (add **\$901.59** list)

- F Right +Left Power + USB - White (add **\$901.59** list)

3 Glide Option:

- H Plastic Glide
- K Felt Glide

2) Seat, back and arm material.

3) Screen material (if applicable).

See chart (next page) for upcharge.

4) Leg color.

Tables

Square

Square

Square Table Freestanding

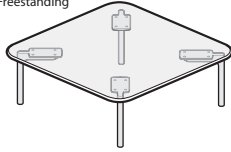

S910

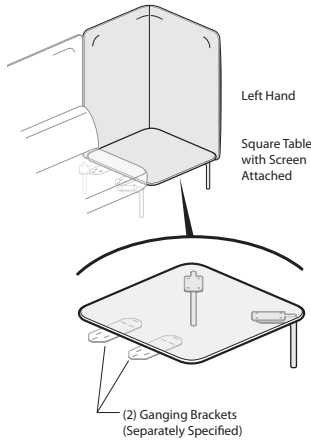

S914
Class CB

Features

- Includes 1"(25mm) thick table top and four legs with optional Low or High screen.
- Top available in painted MDF or planked wood in White Oak or Walnut.
- Legs - painted cast aluminum.
- Glides - Black plastic or felt with 0.5"(13mm) leveling adjustment.
- COM yardage: (COL N/A on screens)
Screen Low: 3.75/N/A High: 4.0/N/A

Specification Tips

- Tables without screens can be used as freestanding or ganged to a Cabana seating unit.
- Tables with screens must be ganged to other Cabana seating using separately specified Ganging Brackets or Ganging Kit. Cannot gang to arm, back or screen locations due to interference. For options see Specification Guide.
- When ganging, table legs may be removed from ganging location.
- Screen material is applied railroaded.
- Linear or patterned fabric not recommended due to the way material is applied.
- Screens are handed and cannot be field modified.
- Product Number changes based on screen height and right or left orientation. Please ensure correct Number is ordered.
- Table can be powered with separately specified and field installed Bezel Utility Module EURT-00 _ _ . Bezel Utility Modules ship standard with 6'(1829mm) or 12'(3658mm) cord lengths.
- Screens are designed to work with separately specified:
 - Shelf S9SH-0
 - Coat Hook HOCH-0000
- See Specification Guide for Application Details.

Dimensions

Height:	Depth:	Width:
No screen - 10"(254mm)	No screen - 30"(762mm)	No Screen - 30"(762mm)
Low Screen - 42"(1067mm)	With Screen - 32"(813mm)	With Screen - 32"(813mm)
High Screen - 54"(1372mm)		

To Order, Specify:

1) Product number, including:

1 **Glide Style:**

- H** Plastic Glide
- K** Felt Glide

2) Surface material/color.

3) Screen material (if applicable).

4) Leg color.

Description	Number	Price	Seat, Back & Arms Fabric							
			A	B	C	D	E	F	G	H
No Screen										
Painted MDF	S910-P00-	\$ 2106.29	N/A	N/A	N/A	N/A	N/A	N/A	N/A	N/A
Plank White Oak	S910-W00-	4228.11	N/A	N/A	N/A	N/A	N/A	N/A	N/A	N/A
Plank Walnut	S910-W00-	5215.21	N/A	N/A	N/A	N/A	N/A	N/A	N/A	N/A
Low Screen - Right Hand										
Painted MDF	S911-P02-	N/A	\$3230.16	\$3494.42	\$3642.09	\$3929.66	\$ 4124.00	\$5041.11	\$5592.94	\$6580.03
Plank White Oak	S911-W02-	N/A	5351.98	5616.24	5763.91	6051.48	6245.82	7162.93	7714.76	8701.85
Plank Walnut	S911-W02-	N/A	6339.08	6603.34	6751.01	7038.58	7232.92	8150.03	8701.86	9688.95
Low Screen - Left Hand										
Painted MDF	S913-P02-	N/A	\$3230.16	\$3494.42	\$3642.09	\$3929.66	\$ 4124.00	\$5041.11	\$5592.94	\$6580.03
Plank White Oak	S913-W02-	N/A	5351.98	5616.24	5763.91	6051.48	6245.82	7162.93	7714.76	8701.85
Plank Walnut	S913-W02-	N/A	6339.08	6603.34	6751.01	7038.58	7232.92	8150.03	8701.86	9688.95
High Screen - Right Hand										
Painted MDF	S912-P02-	N/A	\$3230.16	\$3494.42	\$3642.09	\$3929.66	\$ 4124.00	\$5041.11	\$5592.94	\$6580.03
Plank White Oak	S912-W02-	N/A	5351.98	5616.24	5763.91	6051.48	6245.82	7162.93	7714.76	8701.85
Plank Walnut	S912-W02-	N/A	6339.08	6603.34	6751.01	7038.58	7232.92	8150.03	8701.86	9688.95
High Screen - Left Hand										
Painted MDF	S914-P02-	N/A	\$3230.16	\$3494.42	\$3642.09	\$3929.66	\$ 4124.00	\$5041.11	\$5592.94	\$6580.03
Plank White Oak	S914-W02-	N/A	5351.98	5616.24	5763.91	6051.48	6245.82	7162.93	7714.76	8701.85
Plank Walnut	S914-W02-	N/A	6339.08	6603.34	6751.01	7038.58	7232.92	8150.03	8701.86	9688.95

Tables

Square Tiered

Square Tiered

Square Tiered Freestanding

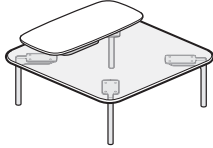

S920

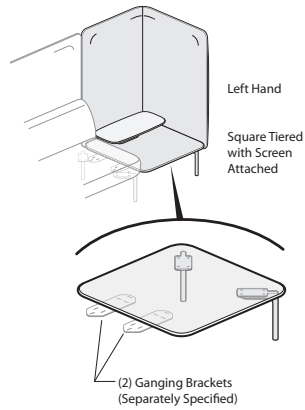

S924
Class CB

Features

- Includes 1"(25mm) thick square table top, second tier small rectangular 0.75"(19mm) thick top on stanchion and four legs with optional Low or High screen.
- Lower table surface available in painted MDF or planked wood in White Oak or Walnut.
- Upper surface available in painted MDF or planked wood in White Oak or Walnut. Upper surface material may be different from lower surface.
- Upper surface is 12.25"(311mm)D x 26.5"(673mm)W. Stanchion height is 3.5"(89mm)
- Legs - painted cast aluminum.
- Glides - Black plastic or felt with 0.5"(13mm) leveling adjustment.
- COM yardage: (COL N/A on screens)
Screen Low: 3.75/N/A High: 4.0/N/A

Specification Tips

- Tables without screens can be used as freestanding or ganged to a Cabana seating unit.
- Tables with screens must be ganged to other Cabana seating using separately specified Ganging Brackets or Ganging Kit. Cannot gang to arm, back or screen locations due to interference. For options see Specification Guide.
- When ganging, table legs may be removed from ganging location.
- Screen material applied railroaded.
- Linear or patterned fabric not recommended due to the way material is applied.
- Screens are handed and cannot be field modified.
- Product Number changes based on screen height and right or left orientation. Please ensure correct Number is ordered.
- Table can be powered with separately specified and field installed Bezel Utility Module EURT-00 __. Bezel Utility Modules ship standard with 6'(1829mm) or 12'(3658mm) cord lengths.
- The upper tier stanchion mount allows cord management through the table.
- Upper tier stanchion location is fixed and cannot be field modified.
- Screens are designed to work with separately specified:
 - Shelf S9SH-0
 - Coat Hook HOCH-0000
- See Specification Guide for Application Details.

Dimensions

Height:	Depth:	Width:
No screen - 10"(254mm)	No screen - 30"(762mm)	No Screen - 30"(762mm)
Low Screen - 42"(1067mm)	With Screen - 32"(813mm)	With Screen - 32"(813mm)
High Screen - 54"(1372mm)		

To Order, Specify:

1) Product number, including:

1 **Glide Style:**

- H** Plastic Glide
- K** Felt Glide

2) Lower surface material/color.

3) Upper surface material/color.

4) Screen material (if applicable).

5) Trim color.

Tables

Square Tiered

Lower Surface	Upper Surface	Number	Price	Screen Fabric								
				A	B	C	D	E	F	G	H	
No Screen												
Painted MDF	Painted MDF	S920-PP0-█	\$ 2751.38	N/A	N/A	N/A	N/A	N/A	N/A	N/A	N/A	N/A
Painted MDF	Plank White Oak	S920-PW0-█	4531.26	N/A	N/A	N/A	N/A	N/A	N/A	N/A	N/A	N/A
Painted MDF	Plank Walnut	S920-PW0-█	4632.30	N/A	N/A	N/A	N/A	N/A	N/A	N/A	N/A	N/A
Plank White Oak	Painted MDF	S920-WP0-█	4873.20	N/A	N/A	N/A	N/A	N/A	N/A	N/A	N/A	N/A
Plank White Oak	Plank White Oak	S920-WW0-█	6653.08	N/A	N/A	N/A	N/A	N/A	N/A	N/A	N/A	N/A
Plank White Oak	Plank Walnut	S920-WW0-█	6754.12	N/A	N/A	N/A	N/A	N/A	N/A	N/A	N/A	N/A
Plank Walnut	Painted MDF	S920-WP0-█	5860.30	N/A	N/A	N/A	N/A	N/A	N/A	N/A	N/A	N/A
Plank Walnut	Plank White Oak	S920-WW0-█	7640.18	N/A	N/A	N/A	N/A	N/A	N/A	N/A	N/A	N/A
Plank Walnut	Plank Walnut	S920-WW0-█	7741.22	N/A	N/A	N/A	N/A	N/A	N/A	N/A	N/A	N/A
Low Screen - Right Hand												
Painted MDF	Painted MDF	S921-PP2-█	N/A	\$ 3875.25	\$ 4139.51	\$ 4287.18	\$ 4574.75	\$ 4769.09	\$ 5686.20	\$ 6238.03	\$ 7225.12	
Painted MDF	Plank White Oak	S921-PW2-█	N/A	5655.13	5919.39	6067.06	6354.63	6548.97	7466.08	8017.91	9005.00	
Painted MDF	Plank Walnut	S921-PW2-█	N/A	5756.17	6020.43	6168.10	6455.67	6650.01	7567.12	8118.95	9106.04	
Plank White Oak	Painted MDF	S921-WP2-█	N/A	5997.07	6261.33	6409.00	6696.57	6890.91	7808.02	8359.85	9346.94	
Plank White Oak	Plank White Oak	S921-WW2-█	N/A	7776.95	8041.21	8188.88	8476.45	8670.79	9587.90	10139.73	11126.82	
Plank White Oak	Plank Walnut	S921-WW2-█	N/A	7877.99	8142.25	8289.92	8577.49	8771.83	9688.94	10240.77	11227.86	
Plank Walnut	Painted MDF	S921-WP2-█	N/A	6984.17	7248.43	7396.10	7683.67	7878.01	8795.12	9346.95	10334.04	
Plank Walnut	Plank White Oak	S921-WW2-█	N/A	8764.05	9028.31	9175.98	9463.55	9657.89	10575.00	11126.83	12113.92	
Plank Walnut	Plank Walnut	S921-WW2-█	N/A	8865.09	9129.35	9277.02	9564.59	9758.93	10676.04	11227.87	12214.96	
Low Screen - Left Hand												
Painted MDF	Painted MDF	S923-PP2-█	N/A	\$ 3875.25	\$ 4139.51	\$ 4287.18	\$ 4574.75	\$ 4769.09	\$ 5686.20	\$ 6238.03	\$ 7225.12	
Painted MDF	Plank White Oak	S923-PW2-█	N/A	5655.13	5919.39	6067.06	6354.63	6548.97	7466.08	8017.91	9005.00	
Painted MDF	Plank Walnut	S923-PW2-█	N/A	5756.17	6020.43	6168.10	6455.67	6650.01	7567.12	8118.95	9106.04	
Plank White Oak	Painted MDF	S923-WP2-█	N/A	5997.07	6261.33	6409.00	6696.57	6890.91	7808.02	8359.85	9346.94	
Plank White Oak	Plank White Oak	S923-WW2-█	N/A	7776.95	8041.21	8188.88	8476.45	8670.79	9587.90	10139.73	11126.82	
Plank White Oak	Plank Walnut	S923-WW2-█	N/A	7877.99	8142.25	8289.92	8577.49	8771.83	9688.94	10240.77	11227.86	
Plank Walnut	Painted MDF	S923-WP2-█	N/A	6984.17	7248.43	7396.10	7683.67	7878.01	8795.12	9346.95	10334.04	
Plank Walnut	Plank White Oak	S923-WW2-█	N/A	8764.05	9028.31	9175.98	9463.55	9657.89	10575.00	11126.83	12113.92	
Plank Walnut	Plank Walnut	S923-WW2-█	N/A	8865.09	9129.35	9277.02	9564.59	9758.93	10676.04	11227.87	12214.96	
High Screen - Right Hand												
Painted MDF	Painted MDF	S922-PP2-█	N/A	\$ 3875.25	\$ 4139.51	\$ 4287.18	\$ 4574.75	\$ 4769.09	\$ 5686.20	\$ 6238.03	\$ 7225.12	
Painted MDF	Plank White Oak	S922-PW2-█	N/A	5655.13	5919.39	6067.06	6354.63	6548.97	7466.08	8017.91	9005.00	
Painted MDF	Plank Walnut	S922-PW2-█	N/A	5756.17	6020.43	6168.10	6455.67	6650.01	7567.12	8118.95	9106.04	
Plank White Oak	Painted MDF	S922-WP2-█	N/A	5997.07	6261.33	6409.00	6696.57	6890.91	7808.02	8359.85	9346.94	
Plank White Oak	Plank White Oak	S922-WW2-█	N/A	7776.95	8041.21	8188.88	8476.45	8670.79	9587.90	10139.73	11126.82	
Plank White Oak	Plank Walnut	S922-WW2-█	N/A	7877.99	8142.25	8289.92	8577.49	8771.83	9688.94	10240.77	11227.86	
Plank Walnut	Painted MDF	S922-WP2-█	N/A	6984.17	7248.43	7396.10	7683.67	7878.01	8795.12	9346.95	10334.04	
Plank Walnut	Plank White Oak	S922-WW2-█	N/A	8764.05	9028.31	9175.98	9463.55	9657.89	10575.00	11126.83	12113.92	
Plank Walnut	Plank Walnut	S922-WW2-█	N/A	8865.09	9129.35	9277.02	9564.59	9758.93	10676.04	11227.87	12214.96	
High Screen - Left Hand												
Painted MDF	Painted MDF	S924-PP2-█	N/A	\$ 3875.25	\$ 4139.51	\$ 4287.18	\$ 4574.75	\$ 4769.09	\$ 5686.20	\$ 6238.03	\$ 7225.12	
Painted MDF	Plank White Oak	S924-PW2-█	N/A	5655.13	5919.39	6067.06	6354.63	6548.97	7466.08	8017.91	9005.00	
Painted MDF	Plank Walnut	S924-PW2-█	N/A	5756.17	6020.43	6168.10	6455.67	6650.01	7567.12	8118.95	9106.04	
Plank White Oak	Painted MDF	S924-WP2-█	N/A	5997.07	6261.33	6409.00	6696.57	6890.91	7808.02	8359.85	9346.94	
Plank White Oak	Plank White Oak	S924-WW2-█	N/A	7776.95	8041.21	8188.88	8476.45	8670.79	9587.90	10139.73	11126.82	
Plank White Oak	Plank Walnut	S924-WW2-█	N/A	7877.99	8142.25	8289.92	8577.49	8771.83	9688.94	10240.77	11227.86	
Plank Walnut	Painted MDF	S924-WP2-█	N/A	6984.17	7248.43	7396.10	7683.67	7878.01	8795.12	9346.95	10334.04	
Plank Walnut	Plank White Oak	S924-WW2-█	N/A	8764.05	9028.31	9175.98	9463.55	9657.89	10575.00	11126.83	12113.92	
Plank Walnut	Plank Walnut	S924-WW2-█	N/A	8865.09	9129.35	9277.02	9564.59	9758.93	10676.04	11227.87	12214.96	

Tables

Rectangle

Rectangle

Rectangular Table
Freestanding

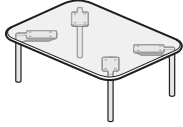

S930

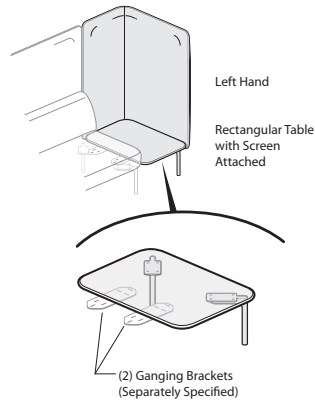

S934
Class CB

Features

- Includes 1"(25mm) thick table top and four legs with optional Low or High screen.
- Top available in painted MDF or planked wood in White Oak or Walnut.
- Legs - painted cast aluminum.
- Glides - Black plastic or felt with 0.5"(13mm) leveling adjustment.
- COM yardage: (COL N/A on screens)
Screen Low: 3.25/N/A High: 3.5/N/A

Specification Tips

- Tables without screens can be used as freestanding or ganged to a Cabana seating unit.
- Tables with screens must be ganged to other Cabana seating using separately specified Ganging Brackets or Ganging Kit. Cannot gang to arm, back or screen locations due to interference. For options see Specification Guide.
- When ganging, table legs may be removed from ganging location.
- Screen material is applied railroaded.
- Linear or patterned material not recommended due to the way material is applied.
- Screens are handed and cannot be field modified.
- Product Number changes based on screen height and right or left orientation. Please ensure correct Number is ordered.
- Table can be powered with separately specified and field installed Bezel Utility Module EURT-00_ __. Bezel Utility Modules ship standard with 6'(1829mm) or 12'(3658mm) cord lengths.
- Screens are designed to work with separately specified:
 - Shelf S9SH-0
 - Coat Hook HOCH-0000
- See Specification Guide for Application Details.

Dimensions

Height:	Depth:	Width:
No screen - 10"(254mm)	No screen - 30"(762mm)	No Screen - 21"(533mm)
Low Screen - 42"(1067mm)	With Screen - 32"(813mm)	With Screen - 23"(584mm)
High Screen - 54"(1372mm)		

To Order, Specify:

1) Product number, including:

1 **Glide Style:**

- H** Plastic Glide
- K** Felt Glide

2) Surface material/color.

3) Screen material (if applicable).

4) Leg color.

Description	Number	Price	Screen Fabric							
			A	B	C	D	E	F	G	H
No Screen										
Painted MDF	S930-P00-█	\$ 1554.45	N/A	N/A	N/A	N/A	N/A	N/A	N/A	N/A
Plank White Oak	S930-W00-█	3559.70	N/A	N/A	N/A	N/A	N/A	N/A	N/A	N/A
Plank Walnut	S930-W00-█	4212.58	N/A	N/A	N/A	N/A	N/A	N/A	N/A	N/A
Low Screen - Right Hand										
Painted MDF	S931-P02-█	N/A	\$2562.53	\$ 2795.69	\$2920.06	\$ 3168.77	\$ 3347.54	\$ 4148.08	\$4629.97	\$5492.70
Plank White Oak	S931-W02-█	N/A	4567.78	4800.94	4925.31	5174.02	5352.79	6153.33	6635.22	7497.95
Plank Walnut	S931-W02-█	N/A	5220.66	5453.82	5578.19	5826.90	6005.67	6806.21	7288.10	8150.83
Low Screen - Left Hand										
Painted MDF	S933-P02-█	N/A	\$2562.53	\$ 2795.69	\$2920.06	\$ 3168.77	\$ 3347.54	\$ 4148.08	\$4629.97	\$5492.70
Plank White Oak	S933-W02-█	N/A	4567.78	4800.94	4925.31	5174.02	5352.79	6153.33	6635.22	7497.95
Plank Walnut	S933-W02-█	N/A	5220.66	5453.82	5578.19	5826.90	6005.67	6806.21	7288.10	8150.83
High Screen - Right Hand										
Painted MDF	S932-P02-█	N/A	\$2562.53	\$ 2795.69	\$2920.06	\$ 3168.77	\$ 3347.54	\$ 4148.08	\$4629.97	\$5492.70
Plank White Oak	S932-W02-█	N/A	4567.78	4800.94	4925.31	5174.02	5352.79	6153.33	6635.22	7497.95
Plank Walnut	S932-W02-█	N/A	5220.66	5453.82	5578.19	5826.90	6005.67	6806.21	7288.10	8150.83
High Screen - Left Hand										
Painted MDF	S934-P02-█	N/A	\$2562.53	\$ 2795.69	\$2920.06	\$ 3168.77	\$ 3347.54	\$ 4148.08	\$4629.97	\$5492.70
Plank White Oak	S934-W02-█	N/A	4567.78	4800.94	4925.31	5174.02	5352.79	6153.33	6635.22	7497.95
Plank Walnut	S934-W02-█	N/A	5220.66	5453.82	5578.19	5826.90	6005.67	6806.21	7288.10	8150.83

Tables

Rectangle Tiered

Rectangle Tiered

Rectangular Table
Freestanding

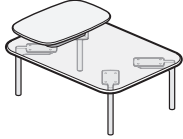

S940

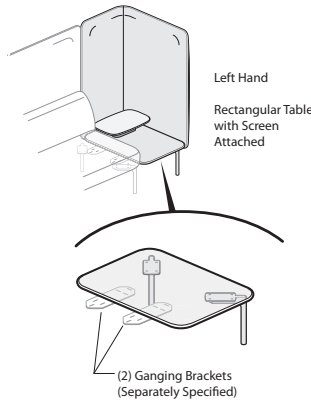

S944
Class CB

Features

- Includes 1"(25mm) thick rectangular table top, second tier small rectangular 0.75"(19mm) thick top on stanchion and four legs with optional Low or High screen.
- Lower table surface available in painted MDF or planked wood in White Oak or Walnut.
- Upper surface available in painted MDF or planked wood in White Oak or Walnut. Upper surface material may be different from lower surface.
- Upper surface is 12.25"(311mm)D x 18.5"(673mm)W. Stanchion height is 3.5"(89mm).
- Legs - painted cast aluminum.
- Glides - Black plastic or felt with 0.5"(13mm) leveling adjustment.
- COM yardage: (COL N/A on screens)
Screen Low: 3.25/N/A High: 3.5/N/A

Specification Tips

- Tables without screens can be used as freestanding or ganged to a Cabana seating unit.
- Tables with screens must be ganged to other Cabana seating using separately specified Ganging Brackets or Ganging Kit. Cannot gang to arm, back or screen locations due to interference. For options see Specification Guide.
- When ganging, table legs may be removed from ganging location.
- Screen material applied railroaded.
- Linear or patterned material not recommended due to the way material is applied.
- Screens are handed and cannot be field modified.
- Product Number changes based on screen height and right or left orientation. Please ensure correct Number is ordered.
- Table can be powered with separately specified and field installed Bezel Utility Module EURT-00 __. Bezel Utility Modules ship standard with 6'(1829mm) or 12'(3658mm) cord lengths.
- The upper tier stanchion mount allows cord management through the table.
- Upper tier stanchion is factory installed and cannot be field modified.
- Screens are designed to work with separately specified:
 - Shelf S9SH-0
 - Coat Hook HOCH-0000
- See Specification Guide for Application Details.

Dimensions

Height:	Depth:	Width:
No screen - 10"(254mm)	No screen - 30"(762mm)	No Screen - 21"(533mm)
Low Screen - 42"(1067mm)	With Screen - 32"(813mm)	With Screen - 23"(584mm)
High Screen - 54"(1372mm)		

To Order, Specify:

1) Product number, including:

1 **Glide Style:**

H Plastic Glide

K Felt Glide

2) Lower surface material/color.

3) Upper surface material/color.

4) Screen material (if applicable).

5) Trim color.

Tables

Rectangle Tiered

Lower Surface	Upper Surface	Number	Price	Screen Fabric								
				A	B	C	D	E	F	G	H	
No Screen												
Painted MDF	Painted MDF	S940-PP0-█	\$ 2114.05	N/A	N/A	N/A	N/A	N/A	N/A	N/A	N/A	N/A
Painted MDF	Plank White Oak	S940-PW0-█	4119.31	N/A	N/A	N/A	N/A	N/A	N/A	N/A	N/A	N/A
Painted MDF	Plank Walnut	S940-PW0-█	4274.75	N/A	N/A	N/A	N/A	N/A	N/A	N/A	N/A	N/A
Plank White Oak	Painted MDF	S940-WP0-█	4119.30	N/A	N/A	N/A	N/A	N/A	N/A	N/A	N/A	N/A
Plank White Oak	Plank White Oak	S940-WW0-█	6124.56	N/A	N/A	N/A	N/A	N/A	N/A	N/A	N/A	N/A
Plank White Oak	Plank Walnut	S940-WW0-█	6280.00	N/A	N/A	N/A	N/A	N/A	N/A	N/A	N/A	N/A
Plank Walnut	Painted MDF	S940-WP0-█	4772.18	N/A	N/A	N/A	N/A	N/A	N/A	N/A	N/A	N/A
Plank Walnut	Plank White Oak	S940-WW0-█	6777.44	N/A	N/A	N/A	N/A	N/A	N/A	N/A	N/A	N/A
Plank Walnut	Plank Walnut	S940-WW0-█	6932.88	N/A	N/A	N/A	N/A	N/A	N/A	N/A	N/A	N/A
Low Screen - Right Hand												
Painted MDF	Painted MDF	S941-PP2-█	N/A	\$ 3122.13	\$3355.29	\$3479.66	\$3728.37	\$3907.14	\$4707.68	\$5189.57	\$6052.30	
Painted MDF	Plank White Oak	S941-PW2-█	N/A	5127.39	5360.55	5484.92	5733.63	5912.40	6712.94	7194.83	8057.56	
Painted MDF	Plank Walnut	S941-PW2-█	N/A	5282.83	5515.99	5640.36	5889.07	6067.84	6868.38	7350.27	8213.00	
Plank White Oak	Painted MDF	S941-WP2-█	N/A	5127.38	5360.54	5484.91	5733.62	5912.39	6712.93	7194.82	8057.55	
Plank White Oak	Plank White Oak	S941-WW2-█	N/A	7132.64	7365.80	7490.17	7738.88	7917.65	8718.19	9200.08	10062.81	
Plank White Oak	Plank Walnut	S941-WW2-█	N/A	7288.08	7521.24	7645.61	7894.32	8073.09	8873.63	9355.52	10218.25	
Plank Walnut	Painted MDF	S941-WP2-█	N/A	5780.26	6013.42	6137.79	6386.50	6565.27	7365.81	7847.70	8710.43	
Plank Walnut	Plank White Oak	S941-WW2-█	N/A	7785.52	8018.68	8143.05	8391.76	8570.53	9371.07	9852.96	10715.69	
Plank Walnut	Plank Walnut	S941-WW2-█	N/A	7940.96	8174.12	8298.49	8547.20	8725.97	9526.51	10008.40	10871.13	
Low Screen - Left Hand												
Painted MDF	Painted MDF	S943-PP2-█	N/A	\$ 3122.13	\$3355.29	\$3479.66	\$3728.37	\$3907.14	\$4707.68	\$5189.57	\$6052.30	
Painted MDF	Plank White Oak	S943-PW2-█	N/A	5127.39	5360.55	5484.92	5733.63	5912.40	6712.94	7194.83	8057.56	
Painted MDF	Plank Walnut	S943-PW2-█	N/A	5282.83	5515.99	5640.36	5889.07	6067.84	6868.38	7350.27	8213.00	
Plank White Oak	Painted MDF	S943-WP2-█	N/A	5127.38	5360.54	5484.91	5733.62	5912.39	6712.93	7194.82	8057.55	
Plank White Oak	Plank White Oak	S943-WW2-█	N/A	7132.64	7365.80	7490.17	7738.88	7917.65	8718.19	9200.08	10062.81	
Plank White Oak	Plank Walnut	S943-WW2-█	N/A	7288.08	7521.24	7645.61	7894.32	8073.09	8873.63	9355.52	10218.25	
Plank Walnut	Painted MDF	S943-WP2-█	N/A	5780.26	6013.42	6137.79	6386.50	6565.27	7365.81	7847.70	8710.43	
Plank Walnut	Plank White Oak	S943-WW2-█	N/A	7785.52	8018.68	8143.05	8391.76	8570.53	9371.07	9852.96	10715.69	
Plank Walnut	Plank Walnut	S943-WW2-█	N/A	7940.96	8174.12	8298.49	8547.20	8725.97	9526.51	10008.40	10871.13	
High Screen - Right Hand												
Painted MDF	Painted MDF	S942-PP2-█	N/A	\$ 3122.13	\$3355.29	\$3479.66	\$3728.37	\$3907.14	\$4707.68	\$5189.57	\$6052.30	
Painted MDF	Plank White Oak	S942-PW2-█	N/A	5127.39	5360.55	5484.92	5733.63	5912.40	6712.94	7194.83	8057.56	
Painted MDF	Plank Walnut	S942-PW2-█	N/A	5282.83	5515.99	5640.36	5889.07	6067.84	6868.38	7350.27	8213.00	
Plank White Oak	Painted MDF	S942-WP2-█	N/A	5127.38	5360.54	5484.91	5733.62	5912.39	6712.93	7194.82	8057.55	
Plank White Oak	Plank White Oak	S942-WW2-█	N/A	7132.64	7365.80	7490.17	7738.88	7917.65	8718.19	9200.08	10062.81	
Plank White Oak	Plank Walnut	S942-WW2-█	N/A	7288.08	7521.24	7645.61	7894.32	8073.09	8873.63	9355.52	10218.25	
Plank Walnut	Painted MDF	S942-WP2-█	N/A	5780.26	6013.42	6137.79	6386.50	6565.27	7365.81	7847.70	8710.43	
Plank Walnut	Plank White Oak	S942-WW2-█	N/A	7785.52	8018.68	8143.05	8391.76	8570.53	9371.07	9852.96	10715.69	
Plank Walnut	Plank Walnut	S942-WW2-█	N/A	7940.96	8174.12	8298.49	8547.20	8725.97	9526.51	10008.40	10871.13	
High Screen - Left Hand												
Painted MDF	Painted MDF	S944-PP2-█	N/A	\$ 3122.13	\$3355.29	\$3479.66	\$3728.37	\$3907.14	\$4707.68	\$5189.57	\$6052.30	
Painted MDF	Plank White Oak	S944-PW2-█	N/A	5127.39	5360.55	5484.92	5733.63	5912.40	6712.94	7194.83	8057.56	
Painted MDF	Plank Walnut	S944-PW2-█	N/A	5282.83	5515.99	5640.36	5889.07	6067.84	6868.38	7350.27	8213.00	
Plank White Oak	Painted MDF	S944-WP2-█	N/A	5127.38	5360.54	5484.91	5733.62	5912.39	6712.93	7194.82	8057.55	
Plank White Oak	Plank White Oak	S944-WW2-█	N/A	7132.64	7365.80	7490.17	7738.88	7917.65	8718.19	9200.08	10062.81	
Plank White Oak	Plank Walnut	S944-WW2-█	N/A	7288.08	7521.24	7645.61	7894.32	8073.09	8873.63	9355.52	10218.25	
Plank Walnut	Painted MDF	S944-WP2-█	N/A	5780.26	6013.42	6137.79	6386.50	6565.27	7365.81	7847.70	8710.43	
Plank Walnut	Plank White Oak	S944-WW2-█	N/A	7785.52	8018.68	8143.05	8391.76	8570.53	9371.07	9852.96	10715.69	
Plank Walnut	Plank Walnut	S944-WW2-█	N/A	7940.96	8174.12	8298.49	8547.20	8725.97	9526.51	10008.40	10871.13	

Tables

Wedge

Wedge



S950

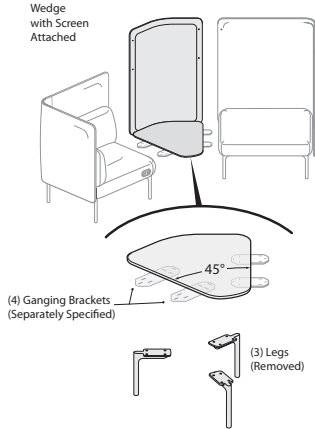

S956
Class CB

Features

- Includes 1"(25mm) thick 45° table top and three legs with optional Low or High screen.
- Top available in painted MDF or planked wood in White Oak or Walnut.
- Legs - painted cast aluminum.
- Glides - Black plastic or felt with 0.5"(13mm) leveling adjustment.
- COM yardage: (COL N/A on screens)
Screen Low: 2.25/N/A High: 2.5/N/A

Specification Tips

- Tables without screens can be used as freestanding or ganged to a Cabana seating unit.
- Tables with screens must be ganged to other Cabana seating using separately specified Ganging Brackets or Ganging Kit. Cannot gang to arm, back or screen locations due to interference. For options see Specification Guide.
- Legs should not be used when ganging.
- Screen material applied railroaded.
- Linear or patterned fabric not recommended due to the way material is applied.
- Screens cannot be field modified.
- Product Number changes based on screen height. Please ensure correct Number is ordered.
- Table can be powered with separately specified and field installed Bezel Utility Module EURT-00 __. Bezel Utility Modules ship standard with 6'(1829mm) or 12'(3658mm) cord lengths.
- Screens are designed to work with separately specified:
 - Shelf S9SH-0
 - Coat Hook HOCH-0000
- See Specification Guide for Application Details.

Dimensions

Height:	Depth:	Width:
No screen - 10"(254mm)	No screen - 30"(762mm)	28"(711mm)
Low Screen - 42"(1067mm)	With Screen - 32"(813mm)	
High Screen - 54"(1372mm)		

To Order, Specify:

1) Product number, including:

1 **Glide Style:**

- H** Plastic Glide
- K** Felt Glide

2) Surface material/color.

3) Screen material (if applicable).

4) Leg color.

Description	Number	Price	Screen Fabric							
			A	B	C	D	E	F	G	H
No Screen										
Painted MDF	S950-P00- <input type="checkbox"/>	\$ 1818.71	N/A	N/A	N/A	N/A	N/A	N/A	N/A	N/A
Plank White Oak	S950-W00- <input type="checkbox"/>	4134.85	N/A	N/A	N/A	N/A	N/A	N/A	N/A	N/A
Plank Walnut	S950-W00- <input type="checkbox"/>	5129.71	N/A	N/A	N/A	N/A	N/A	N/A	N/A	N/A
Low Screen										
Painted MDF	S955-P02- <input type="checkbox"/>	N/A	\$2942.58	\$3074.73	\$ 3152.44	\$3292.35	\$3393.38	\$3844.18	\$ 4123.96	\$ 4613.63
Plank White Oak	S955-W02- <input type="checkbox"/>	N/A	5258.72	5390.87	5468.58	5608.49	5709.52	6160.32	6440.10	6929.77
Plank Walnut	S955-W02- <input type="checkbox"/>	N/A	6253.58	6385.73	6463.44	6603.35	6704.38	7155.18	7434.96	7924.63
High Screen										
Painted MDF	S956-P02- <input type="checkbox"/>	N/A	\$2942.58	\$3074.73	\$ 3152.44	\$3292.35	\$3393.38	\$3844.18	\$ 4123.96	\$ 4613.63
Plank White Oak	S956-W02- <input type="checkbox"/>	N/A	5258.72	5390.87	5468.58	5608.49	5709.52	6160.32	6440.10	6929.77
Plank Walnut	S956-W02- <input type="checkbox"/>	N/A	6253.58	6385.73	6463.44	6603.35	6704.38	7155.18	7434.96	7924.63

Tables

Wedge Tiered

Wedge Tiered

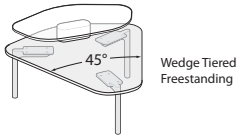

S960

Wedge Tiered with Screen Attached

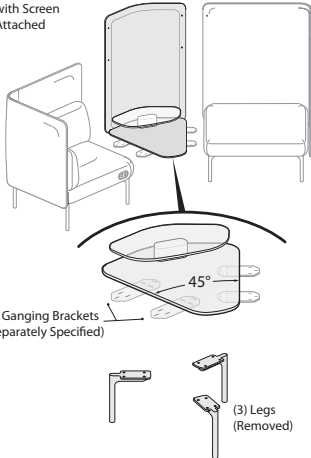

S966
Class CB

Features

- Includes 1"(25mm) thick 45° wedge shape table top, second tier small rectangular 0.75"(19mm) thick top on stanchion and three legs with optional Low or High screen.
- Lower table surface available in painted MDF or planked wood in White Oak or Walnut.
- Upper surface available in painted MDF or planked wood in White Oak or Walnut. Upper surface material may be different from lower surface.
- Upper surface is 13.5"(343mm) D x 24.75"(629mm) W. Stanchion height is 3.5"(89mm)
- Legs - painted cast aluminum.
- Glides - Black plastic or felt with 0.5"(13mm) leveling adjustment.
- COM yardage: (COL N/A on screens)
Screen Low: 2.25/N/A High: 2.5/N/A

Specification Tips

- Tables without screens can be used as freestanding or ganged to a Cabana seating unit.
- Tables with screens must be ganged to other Cabana seating using separately specified Ganging Brackets or Ganging Kit. Cannot gang to arm, back or screen locations due to interference. For options see Specification Guide.
- Legs should not be used when ganging.
- Screen material applied railroaded.
- Linear or patterned fabric not recommended due to the way material is applied.
- Screens cannot be field modified.
- Product Number changes based on screen height. Please ensure correct Number is ordered.
- Table can be powered with separately specified and field installed Bezel Utility Module EURT-00 __. Bezel Utility Modules ship standard with 6'(1829mm) or 12'(3658mm) cord lengths.
- The upper tier stanchion mount allows cord management through the table.
- Upper tier stanchion is factory installed and cannot be field modified.
- Screens are designed to work with separately specified:
 - Shelf S9SH-0
 - Coat Hook HOCH-0000
- See Specification Guide for Application Details.

Dimensions

Height:	Depth:	Width:
No screen - 10"(254mm)	No screen - 30"(762mm)	28"(711mm)
Low Screen - 42"(1067mm)	With Screen - 32"(813mm)	
High Screen - 54"(1372mm)		

To Order, Specify:

1) Product number, including:

1 **Glide Style:**

H Plastic Glide

K Felt Glide

2) Lower surface material/color.

3) Upper surface material/color.

4) Screen material (if applicable).

5) Trim color.

Tables

Wedge Tiered

Lower Surface	Upper Surface	Number	Price	Screen Fabric								
				A	B	C	D	E	F	G	H	
No Screen												
Painted MDF	Painted MDF	S960-PP0-	\$2463.80	N/A	N/A	N/A	N/A	N/A	N/A	N/A	N/A	N/A
Painted MDF	Plank White Oak	S960-PW0-	4096.01	N/A	N/A	N/A	N/A	N/A	N/A	N/A	N/A	N/A
Painted MDF	Plank Walnut	S960-PW0-	5090.84	N/A	N/A	N/A	N/A	N/A	N/A	N/A	N/A	N/A
Plank White Oak	Painted MDF	S960-WP0-	4779.94	N/A	N/A	N/A	N/A	N/A	N/A	N/A	N/A	N/A
Plank White Oak	Plank White Oak	S960-WW0-	6412.15	N/A	N/A	N/A	N/A	N/A	N/A	N/A	N/A	N/A
Plank White Oak	Plank Walnut	S960-WW0-	7406.98	N/A	N/A	N/A	N/A	N/A	N/A	N/A	N/A	N/A
Plank Walnut	Painted MDF	S960-WP0-	5774.80	N/A	N/A	N/A	N/A	N/A	N/A	N/A	N/A	N/A
Plank Walnut	Plank White Oak	S960-WW0-	7407.01	N/A	N/A	N/A	N/A	N/A	N/A	N/A	N/A	N/A
Plank Walnut	Plank Walnut	S960-WW0-	8401.84	N/A	N/A	N/A	N/A	N/A	N/A	N/A	N/A	N/A
Low Screen												
Painted MDF	Painted MDF	S965-PP2-	N/A	\$ 3587.67	\$ 3719.82	\$ 3797.53	\$ 3937.44	\$ 4038.47	\$ 4489.27	\$ 4769.05	\$ 5258.72	
Painted MDF	Plank White Oak	S965-PW2-	N/A	5219.88	5352.03	5429.74	5569.65	5670.68	6121.48	6401.26	6890.93	
Painted MDF	Plank Walnut	S965-PW2-	N/A	6214.71	6346.86	6424.57	6564.48	6665.51	7116.31	7396.09	7885.76	
Plank White Oak	Painted MDF	S965-WP2-	N/A	5903.81	6035.96	6113.67	6253.58	6354.61	6805.41	7085.19	7574.86	
Plank White Oak	Plank White Oak	S965-WW2-	N/A	7536.02	7668.17	7745.88	7885.79	7986.82	8437.62	8717.40	9207.07	
Plank White Oak	Plank Walnut	S965-WW2-	N/A	8530.85	8663.00	8740.71	8880.62	8981.65	9432.45	9712.23	10201.90	
Plank Walnut	Painted MDF	S965-WP2-	N/A	6898.67	7030.82	7108.53	7248.44	7349.47	7800.27	8080.05	8569.72	
Plank Walnut	Plank White Oak	S965-WW2-	N/A	8530.88	8663.03	8740.74	8880.65	8981.68	9432.48	9712.26	10201.93	
Plank Walnut	Plank Walnut	S965-WW2-	N/A	9525.71	9657.86	9735.57	9875.48	9976.51	10427.31	10707.09	11196.76	
High Screen												
Painted MDF	Painted MDF	S966-PP2-	N/A	\$ 3587.67	\$ 3719.82	\$ 3797.53	\$ 3937.44	\$ 4038.47	\$ 4489.27	\$ 4769.05	\$ 5258.72	
Painted MDF	Plank White Oak	S966-PW2-	N/A	5219.88	5352.03	5429.74	5569.65	5670.68	6121.48	6401.26	6890.93	
Painted MDF	Plank Walnut	S966-PW2-	N/A	6214.71	6346.86	6424.57	6564.48	6665.51	7116.31	7396.09	7885.76	
Plank White Oak	Painted MDF	S966-WP2-	N/A	5903.81	6035.96	6113.67	6253.58	6354.61	6805.41	7085.19	7574.86	
Plank White Oak	Plank White Oak	S966-WW2-	N/A	7536.02	7668.17	7745.88	7885.79	7986.82	8437.62	8717.40	9207.07	
Plank White Oak	Plank Walnut	S966-WW2-	N/A	8530.85	8663.00	8740.71	8880.62	8981.65	9432.45	9712.23	10201.90	
Plank Walnut	Painted MDF	S966-WP2-	N/A	6898.67	7030.82	7108.53	7248.44	7349.47	7800.27	8080.05	8569.72	
Plank Walnut	Plank White Oak	S966-WW2-	N/A	8530.88	8663.03	8740.74	8880.65	8981.68	9432.48	9712.26	10201.93	
Plank Walnut	Plank Walnut	S966-WW2-	N/A	9525.71	9657.86	9735.57	9875.48	9976.51	10427.31	10707.09	11196.76	

Chaise Lounge Retreat

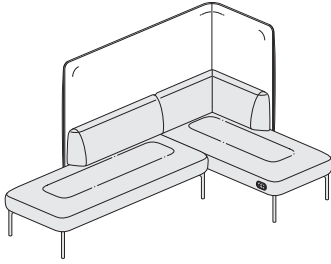

S9EL
Class CB

Features

- Includes: Two-seat sofa with half back, chaise lounge, low or high 30"(762mm) x 72"(1829mm) screen, along with integrated table and embedded power options.
- Embedded Power available in two options:
 - Power - Two Power Receptacles (NEMA-5-15R) per location)
 - Power + USB - One Power Receptacle (NEMA-5-15R) and one Dual USB A-C (20W shared between A and C).
- Power is embedded on unit front on left or right-hand side, or both. When ordering power on both sides the power option will be the same.
- Power housing available in supplier Black or White and has a 10'(3048mm) black cord.
- Integrated table option available on the Half-Back Sofa.
- Integrated table is 0.75"(19mm) thick and 20"(508mm)D x 11"(279mm)W mounted on a 3.5"(89mm)H stanchion.
- Legs - painted cast aluminum.
- Glides - Black plastic or felt with 0.5"(13mm) leveling adjustment.
- COM yardage/COL square footage:
Seating: 8.25/142.25
Screens Low: 6.25/N/A High: 6.5/N/A

Specification Tips

- Gangs on open seat depth with separately specified Cabana seating or tables with or without a screen. Use separately specified Ganging Bracket or Ganging Kit.
- Cannot gang on screen locations due to interference. For options see Specification Guide.
- Chaise Lounge Retreat is handed and comes standard with Low or High screen.
- Sofa and screen fabric are applied railroaded.
- Linear or patterned fabric not recommended due to the way material is applied.
- Seat and Screen may be specified with different materials. To specify, select seat material grade. Next, select screen material and add appropriate upcharge (see chart).
- Embedded Power is factory installed and cannot be field installed. Power type can be field modified with service parts.
- For use with 120 volt 60 hertz electrical system only.**
- Place powered seating within 4"(1219mm) of power source. Power components each have a 10'(3048mm) cord routed to an opening at rear of seating unit.
- Integrated Table is factory installed. The table position is fixed and cannot be field modified.
- The Integrated Table is designed to work with separately specified, field installed, Bezel Utility Module EURT-00__. Table stanchion allows cord management through the seat. Bezel Utility Modules ship standard with 6'(1829mm) or 12'(3658mm) cord lengths.
- The following separately specified items are designed to work with Cabana screens. It is recommended to use these items on High Screens to prevent interference with user.
 - Shelf S9SH-0
 - Coat Hook HOCH-0000
- See Specification Guide for Application Details.
- Powered applications may require approval of local authority having jurisdiction (AHJ); ensure compliance before placing orders or installing.

Dimensions

Height: Depth: Width:
 Low Screen - 42"(1067mm) 62"(1575mm) 28"(711mm)
 High Screen - 54"(1372mm)

To Order, Specify:

1) Product number, including:

1 Seat Upholstery Type:

- 1 Leather
- 2 Fabric

2 Power Option:

- 0 None

Power

- 1 Right Power - Black (add **\$357.53** list)

- A Right Power - White (add **\$357.53** list)

- 2 Left Power - Black (add **\$357.53** list)

- B Left Power - White (add **\$357.53** list)

- 3 Right + Left Power - Black (add **\$715.05** list)

- C Right + Left Power - White (add **\$715.05** list)

Power + USB

- 4 Right Power + USB - Black (add **\$450.79** list)

- D Right Power + USB - White (add **\$450.79** list)

- 5 Left Power + USB - Black (add **\$450.79** list)

- E Left Power + USB - White (add **\$450.79** list)

- 6 Right + Left Power + USB - Black (add **\$901.59** list)

- F Right + Left Power + USB - White (add **\$901.59** list)

3 Glide Option:

- H Plastic Glide
- K Felt Glide

2) Seat, back & arm material.

3) Screen material.

See chart (next page) for upcharge.

4) Trim color.

5) Table finish (if applicable).

Chaise Lounge Retreat

Description	Number			Seat, Back & Arms Fabric								Leather	
	①	②	③	A	B	C	D	E	F	G	H	A	B
Low Screen¹ - No Integrated Table													
Right-Hand	S9ER-L	2-	OO	\$10565.67	\$11094.20	\$11389.54	\$11956.92	\$12353.30	\$14195.35	\$15291.23	\$17265.40	\$15353.42	\$17343.11
Left-Hand	S9EL-L	2-	OO	10565.67	11094.20	11389.54	11956.92	12353.30	14195.35	15291.23	17265.40	15353.42	17343.11
Low Screen¹ - Integrated Table Painted MDF													
Right-Hand	S9ER-L	2-	PO	\$11210.76	\$11739.29	\$12034.63	\$12602.01	\$12998.39	\$14840.44	\$15936.32	\$17910.49	\$15998.51	\$17988.20
Left-Hand	S9EL-L	2-	PO	11210.76	11739.29	12034.63	12602.01	12998.39	14840.44	15936.32	17910.49	15998.51	17988.20
Low Screen¹ - Integrated Table Plank White Oak													
Right-Hand	S9ER-L	2-	WO	\$12734.16	\$13262.69	\$13558.03	\$14125.41	\$14521.79	\$16363.84	\$17459.72	\$19433.89	\$17521.91	\$19511.60
Left-Hand	S9EL-L	2-	WO	12734.16	13262.69	13558.03	14125.41	14521.79	16363.84	17459.72	19433.89	17521.91	19511.60
Low Screen¹ - Integrated Table Plank Walnut													
Right-Hand	S9ER-L	2-	WO	\$12866.26	\$13394.79	\$13690.13	\$14257.51	\$14653.89	\$16495.94	\$17591.82	\$19565.99	\$17654.01	\$19643.70
Left-Hand	S9EL-L	2-	WO	12866.26	13394.79	13690.13	14257.51	14653.89	16495.94	17591.82	19565.99	17654.01	19643.70
High Screen¹ - No Integrated Table													
Right-Hand	S9ER-H	2-	OO	\$10565.67	\$11094.20	\$11389.54	\$11956.92	\$12353.30	\$14195.35	\$15291.23	\$17265.40	\$15353.42	\$17343.11
Left-Hand	S9EL-H	2-	OO	10565.67	11094.20	11389.54	11956.92	12353.30	14195.35	15291.23	17265.40	15353.42	17343.11
High Screen¹ - Integrated Table Painted MDF													
Right-Hand	S9ER-H	2-	PO	\$11210.76	\$11739.29	\$12034.63	\$12602.01	\$12998.39	\$14840.44	\$15936.32	\$17910.49	\$15998.51	\$17988.20
Left-Hand	S9EL-H	2-	PO	11210.76	11739.29	12034.63	12602.01	12998.39	14840.44	15936.32	17910.49	15998.51	17988.20
High Screen¹ - Integrated Table Plank White Oak													
Right-Hand	S9ER-H	2-	WO	\$12734.16	\$13262.69	\$13558.03	\$14125.41	\$14521.79	\$16363.84	\$17459.72	\$19433.89	\$17521.91	\$19511.60
Left-Hand	S9EL-H	2-	WO	12734.16	13262.69	13558.03	14125.41	14521.79	16363.84	17459.72	19433.89	17521.91	19511.60
High Screen¹ - Integrated Table Plank Walnut													
Right-Hand	S9ER-H	2-	WO	\$12866.26	\$13394.79	\$13690.13	\$14257.51	\$14653.89	\$16495.94	\$17591.82	\$19565.99	\$17654.01	\$19643.70
Left-Hand	S9EL-H	2-	WO	12866.26	13394.79	13690.13	14257.51	14653.89	16495.94	17591.82	19565.99	17654.01	19643.70

¹Pricing shown for Low and High Screen reflects screen Grade A pricing. Reference chart for upcharge amounts for higher grade pricing.

Description	A	B	C	D	E	F	G	H
Low Screen (2) 30" x 21"	N/A	\$466.34	\$715.05	\$1212.48	\$1570.01	\$3171.11	\$4134.87	\$5860.32
High Screen (2) 30" x 21"	N/A	\$466.34	\$715.05	\$1212.48	\$1570.01	\$3171.11	\$4134.87	\$5860.32

The following option requires modification of the product number.

Stain repellent (not applicable to screens) To specify, add **P** to the end of the product number (add **\$248.72** to list); **Example:** S9ER-L22-000HP

Half-Back Sofa Retreat

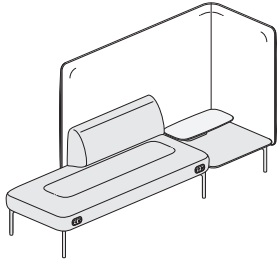

S9F
Class CB

Features

- Includes: Two-seat sofa with half back, square corner table and low or high 30"(762mm) x 72"(1829mm) screen, along with integrated table and embedded power options.
- Embedded Power available in two options:
 - Power - Two Power Receptacles (NEMA-5-15R) per location)
 - Power + USB - One Power Receptacle (NEMA-5-15R) and one Dual USB A-C (20W shared between A and C).
- Power is embedded on unit front on left or right-hand side, or both. When ordering power on both sides the power option will be the same.
- Power housing available in supplier Black or White and has a 10'(3048mm) black cord.
- Square corner table available with or without an upper tier surface.
- Integrated table option available on the Half-Back Sofa.
- Integrated table is 0.75"(19mm) thick and 20"(508mm)D x 11"(279mm)W mounted on a 3.5"(89mm)H stanchion.
- Legs - painted cast aluminum.
- Glides - Black plastic or felt with 0.5"(13mm) leveling adjustment.
- COM yardage/COL square footage:
Seating: 4.0/70
Screens Low: 6.25/N/A High: 6.5/N/A

Specification Tips

- Gangs on open seat depth with separately specified Cabana seating or tables with or without a screen. Use separately specified Ganging Bracket or Ganging Kit.
- Cannot gang on screen locations due to interference. For options see Specification Guide.
- Half-Back Sofa Retreat is handed and comes standard with Low or High screen.
- Sofa and screen fabric are applied railroaded.
- Linear or patterned fabric not recommended due to the way material is applied.
- Seat and Screen may be specified with different materials. To specify, select seat material grade. Next, select screen material and add appropriate upcharge (see chart).
- Embedded Power is factory installed and cannot be field installed. Power type can be field modified with service parts.
- For use with 120 volt 60 hertz electrical system only.**
- Place powered seating within 4"(1219mm) of power source. Power components each have a 10'(3048mm) cord routed to a corresponding opening at rear of seating unit.
- Integrated Table is factory installed. The table position is fixed and cannot be field modified.
- The Integrated Table is designed to work with separately specified, field installed, Bezel Utility Module EURT-00_-. Table stanchion allows cord management through the seat. Bezel Utility Modules ship standard with 6'(1829mm) or 12'(3658mm) cord lengths.
- The following separately specified items are designed to work with Cabana screens. It is recommended to use these items on High Screens or over a table to prevent interference with user.
 - Shelf S9SH-0
 - Coat Hook HOCH-0000
- See Specification Guide for Application Details.
- Powered applications may require approval of local authority having jurisdiction (AHJ); ensure compliance before placing orders or installing.

Dimensions

Height:	Depth:	Width:
Low Screen - 42"(1067mm)	30"(762mm)	104"(2642mm)
High Screen - 54"(1372mm)		

To Order, Specify:

1) Product number, including:

1 Screen Handedness:

- Z** Left Hand
- H** Right Hand

2 Seat Upholstery Type:

- 1** Leather
- 2** Fabric

3 Power Option:

- 0** None

Power

- 1** Right Power - Black (add **\$357.53** list)

- A** Right Power - White (add **\$357.53** list)

- 2** Left Power - Black (add **\$357.53** list)

- B** Left Power - White (add **\$357.53** list)

- 3** Right + Left Power - Black (add **\$715.05** list)

- C** Right + Left Power - White (add **\$715.05** list)

Power + USB

- 4** Right Power + USB - Black (add **\$450.79** list)

- D** Right Power + USB - White (add **\$450.79** list)

- 5** Left Power + USB - Black (add **\$450.79** list)

- E** Left Power + USB - White (add **\$450.79** list)

- 6** Right + Left Power + USB - Black (add **\$901.59** list)

- F** Right + Left Power + USB - White (add **\$901.59** list)

4 Glide Option:

- H** Plastic Glide
- K** Felt Glide

2) Seat, back & arm material.

3) Screen material.

See chart (page 35) for upcharge.

4) Trim color.

5) Integrated table surface/color (if applicable).

6) Corner table surface/color.

7) Upper corner table surface/color (if applicable).

Half-Back Sofa Retreat

Lower Surface	Upper Surface	Number	Seat, Back, & Arms Fabric								Leather				
			①	②	③	④	A	B	C	D	E	F	G	H	A
Low Screen¹ - No Integrated Table															
Painted MDF	None	S9F -L 2-	01	\$ 8552.67	\$ 8801.39	\$ 8941.28	\$ 9205.53	\$ 9392.09	\$ 10254.82	\$ 10767.78	\$ 11692.67	\$ 10876.59	\$ 11809.29		
	Painted MDF	S9F -L 2-	03	9197.76	9446.48	9586.37	9850.62	10037.18	10899.91	11412.87	12337.76	11521.68	12454.38		
	Plank White Oak	S9F -L 2-	04	10977.64	11226.36	11366.25	11630.50	11817.06	12679.79	13192.75	14117.64	13301.56	14234.26		
	Plank Walnut	S9F -L 2-	04	11078.68	11327.40	11467.29	11731.54	11918.10	12780.83	13293.79	14218.68	13402.60	14335.30		
Plank White Oak	None	S9F -L 2-	02	\$ 10674.50	\$ 10923.22	\$ 11063.11	\$ 11327.36	\$ 11513.92	\$ 12376.65	\$ 12889.61	\$ 13814.50	\$ 12998.42	\$ 13931.12		
	Painted MDF	S9F -L 2-	05	11319.59	11568.31	11708.20	11972.45	12159.01	13021.74	13534.70	14459.59	13643.51	14576.21		
	Plank White Oak	S9F -L 2-	06	13099.47	13348.19	13488.08	13752.33	13938.89	14801.62	15314.58	16239.47	15423.39	16356.09		
	Plank Walnut	S9F -L 2-	06	13200.51	13449.23	13589.12	13853.37	14039.93	14902.66	15415.62	16340.51	15524.43	16457.13		
Plank Walnut	None	S9F -L 2-	02	\$ 11661.58	\$ 11910.30	\$ 12050.19	\$ 12314.44	\$ 12501.00	\$ 13363.73	\$ 13876.69	\$ 14801.58	\$ 13985.50	\$ 14918.20		
	Painted MDF	S9F -L 2-	05	12306.67	12555.39	12695.28	12959.53	13146.09	14008.82	14521.78	15446.67	14630.59	15563.29		
	Plank White Oak	S9F -L 2-	06	14086.55	14335.27	14475.16	14739.41	14925.97	15788.70	16301.66	17226.55	16410.47	17343.17		
	Plank Walnut	S9F -L 2-	06	14187.59	14436.31	14576.20	14840.45	15027.01	15889.74	16402.70	17327.59	16511.51	17444.21		
Low Screen¹ - Integrated Table Painted MDF															
Painted MDF	None	S9F -L 2-	P1	\$ 9197.76	\$ 9446.48	\$ 9586.37	\$ 9850.62	\$ 10037.18	\$ 10899.91	\$ 11412.87	\$ 12337.76	\$ 11521.68	\$ 12454.38		
	Painted MDF	S9F -L 2-	P3	9842.85	10091.57	10231.46	10495.71	10682.27	11545.00	12057.96	12982.85	12166.77	13099.47		
	Plank White Oak	S9F -L 2-	P4	11622.73	11871.45	12011.34	12275.59	12462.15	13324.88	13837.84	14762.73	13946.65	14879.35		
	Plank Walnut	S9F -L 2-	P4	11723.77	11972.49	12112.38	12376.63	12563.19	13425.92	13938.88	14863.77	14047.69	14980.39		
Plank White Oak	None	S9F -L 2-	P2	\$ 11319.59	\$ 11568.31	\$ 11708.20	\$ 11972.45	\$ 12159.01	\$ 13021.74	\$ 13534.70	\$ 14459.59	\$ 13643.51	\$ 14576.21		
	Painted MDF	S9F -L 2-	P5	11964.68	12213.40	12353.29	12617.54	12804.10	13666.83	14179.79	15104.68	14288.60	15221.30		
	Plank White Oak	S9F -L 2-	P6	13744.56	13993.28	14133.17	14397.42	14583.98	15446.71	15959.67	16884.56	16068.48	17001.18		
	Plank Walnut	S9F -L 2-	P6	13845.60	14094.32	14234.21	14498.46	14685.02	15547.75	16060.71	16985.60	16169.52	17102.22		
Plank Walnut	None	S9F -L 2-	P2	\$ 12306.67	\$ 12555.39	\$ 12695.28	\$ 12959.53	\$ 13146.09	\$ 14008.82	\$ 14521.78	\$ 15446.67	\$ 14630.59	\$ 15563.29		
	Painted MDF	S9F -L 2-	P5	12951.76	13200.48	13340.37	13604.62	13791.18	14653.91	15166.87	16091.76	15275.68	16208.38		
	Plank White Oak	S9F -L 2-	P6	14731.64	14980.36	15120.25	15384.50	15571.06	16433.79	16946.75	17871.64	17055.56	17988.26		
	Plank Walnut	S9F -L 2-	P6	14832.68	15081.40	15221.29	15485.54	15672.10	16534.83	17047.79	17972.68	17156.60	18089.30		
Low Screen¹ - Integrated Table Plank White Oak															
Painted MDF	None	S9F -L 2-	W1	\$ 10721.16	\$ 10969.88	\$ 1109.77	\$ 11374.02	\$ 11560.58	\$ 12423.31	\$ 12936.27	\$ 13861.16	\$ 13045.08	\$ 13977.78		
	Painted MDF	S9F -L 2-	W3	11366.25	11614.97	11754.86	12019.11	12205.67	13068.40	13581.36	14506.25	13690.17	14622.87		
	Plank White Oak	S9F -L 2-	W4	13146.13	13394.85	13534.74	13798.99	13985.55	14848.28	15361.24	16286.13	15470.05	16402.75		
	Plank Walnut	S9F -L 2-	W4	13247.17	13495.89	13635.78	13900.03	14086.59	14949.32	15462.28	16387.17	15571.09	16503.79		
Plank White Oak	None	S9F -L 2-	W2	\$ 12842.99	\$ 13091.71	\$ 13231.60	\$ 13495.85	\$ 13682.41	\$ 14545.14	\$ 15058.10	\$ 15982.99	\$ 15166.91	\$ 16099.61		
	Painted MDF	S9F -L 2-	W5	13488.08	13736.80	13876.69	14140.94	14327.50	15190.23	15703.19	16628.08	15812.00	16744.70		
	Plank White Oak	S9F -L 2-	W6	15267.96	15516.68	15656.57	15920.82	16107.38	16970.11	17483.07	18407.96	17591.88	18524.58		
	Plank Walnut	S9F -L 2-	W6	15369.00	15617.72	15757.61	16021.86	16208.42	17071.15	17584.11	18509.00	17692.92	18625.62		
Plank Walnut	None	S9F -L 2-	W2	\$ 13830.07	\$ 14078.79	\$ 14218.68	\$ 14482.93	\$ 14669.49	\$ 15532.22	\$ 16045.18	\$ 16970.07	\$ 16153.99	\$ 17086.69		
	Painted MDF	S9F -L 2-	W5	14475.16	14723.88	14863.77	15128.02	15314.58	16177.31	16690.27	17615.16	16799.08	17731.78		
	Plank White Oak	S9F -L 2-	W6	16255.04	16503.76	16643.65	16907.90	17094.46	17957.19	18470.15	19395.04	18578.96	19511.66		
	Plank Walnut	S9F -L 2-	W6	16356.08	16604.80	16744.69	17008.94	17195.50	18058.23	18571.19	19496.08	18680.00	19612.70		
Low Screen¹ - Integrated Table Plank Walnut															
Painted MDF	None	S9F -L 2-	W1	\$ 10853.26	\$ 11101.98	\$ 11241.87	\$ 11506.12	\$ 11692.68	\$ 12555.41	\$ 13068.37	\$ 13993.26	\$ 13177.18	\$ 14109.88		
	Painted MDF	S9F -L 2-	W3	11498.35	11747.07	11886.96	12151.21	12337.77	13200.50	13713.46	14638.35	13822.27	14754.97		
	Plank White Oak	S9F -L 2-	W4	13278.23	13526.95	13666.84	13931.09	14117.65	14980.38	15493.34	16418.23	15602.15	16534.85		
	Plank Walnut	S9F -L 2-	W4	13379.27	13627.99	13767.88	14032.13	14218.69	15081.42	15594.38	16519.27	15703.19	16635.89		
Plank White Oak	None	S9F -L 2-	W2	\$ 12975.09	\$ 13223.81	\$ 13363.70	\$ 13627.95	\$ 13814.51	\$ 14677.24	\$ 15190.20	\$ 16115.09	\$ 15299.01	\$ 16231.71		
	Painted MDF	S9F -L 2-	W5	13620.18	13868.90	14008.79	14273.04	14459.60	15322.33	15835.29	16760.18	15944.10	16876.80		
	Plank White Oak	S9F -L 2-	W6	15400.06	15648.78	15788.67	16052.92	16239.48	17102.21	17615.17	18540.06	17723.98	18656.68		
	Plank Walnut	S9F -L 2-	W6	15501.10	15749.82	15889.71	16153.96	16340.52	17203.25	17716.21	18641.10	17825.02	18757.72		
Plank Walnut	None	S9F -L 2-	W2	\$ 13962.17	\$ 14210.89	\$ 14350.78	\$ 14615.03	\$ 14801.59	\$ 15664.32	\$ 16177.28	\$ 17102.17	\$ 16286.09	\$ 17218.79		
	Painted MDF	S9F -L 2-	W5	14607.26	14855.98	14995.87	15260.12	15446.68	16309.41	16822.37	17747.26	16931.18	17863.88		
	Plank White Oak	S9F -L 2-	W6	16387.14	16635.86	16775.75	17040.00	17226.56	18089.29	18602.25	19527.14	18711.06	19643.76		
	Plank Walnut	S9F -L 2-	W6	16488.18	16736.90	16876.79	17141.04	17327.60	18190.33	18703.29	19628.18	18812.10	19744.80		

¹Pricing shown for Low and High Screen reflects screen Grade A pricing. Reference chart for upcharge amounts for higher grade pricing.

Half-Back Sofa Retreat

Lower Surface	Upper Surface	Number	Seat, Back, & Arms Fabric								Leather				
			①	②	③	④	A	B	C	D	E	F	G	H	A
High Screen¹ - No Integrated Table															
Painted MDF	None	S9F	-H	2-	O1	\$ 8552.67	\$ 8801.39	\$ 8941.28	\$ 9205.53	\$ 9392.09	\$ 10254.82	\$ 10767.78	\$ 11692.67	\$ 10876.59	\$ 11809.29
Painted MDF	S9F	-H	2-	O3	9197.76	9446.48	9586.37	9850.62	10037.18	10899.91	11412.87	12337.76	11521.68	12454.38	
Plank White Oak	S9F	-H	2-	O4	10977.64	11226.36	11366.25	11630.50	11817.06	12679.79	13192.75	14117.64	13301.56	14234.26	
Plank Walnut	S9F	-H	2-	O4	11078.68	11327.40	11467.29	11731.54	11918.10	12780.83	13293.79	14218.68	13402.60	14335.30	
Plank White Oak	None	S9F	-H	2-	O2	\$ 10674.50	\$ 10923.22	\$ 11063.11	\$ 11327.36	\$ 11513.92	\$ 12376.65	\$ 12889.61	\$ 13814.50	\$ 12998.42	\$ 13931.12
Painted MDF	S9F	-H	2-	O5	11319.59	11568.31	11708.20	11972.45	12159.01	13021.74	13534.70	14459.59	13643.51	14576.21	
Plank White Oak	S9F	-H	2-	O6	13099.47	13348.19	13488.08	13752.33	13938.89	14801.62	15314.58	16239.47	15423.39	16356.09	
Plank Walnut	S9F	-H	2-	O6	13200.51	13449.23	13589.12	13853.37	14039.93	14902.66	15415.62	16340.51	15524.43	16457.13	
Plank Walnut	None	S9F	-H	2-	O2	\$ 11661.58	\$ 11910.30	\$ 12050.19	\$ 12314.44	\$ 12501.00	\$ 13363.73	\$ 13876.69	\$ 14801.58	\$ 13985.50	\$ 14918.20
Painted MDF	S9F	-H	2-	O5	12306.67	12555.39	12695.28	12959.53	13146.09	14008.82	14521.78	15446.67	14630.59	15563.29	
Plank White Oak	S9F	-H	2-	O6	14086.55	14335.27	14475.16	14739.41	14925.97	15788.70	16301.66	17226.55	16410.47	17343.17	
Plank Walnut	S9F	-H	2-	O6	14187.59	14436.31	14576.20	14840.45	15027.01	15889.74	16402.70	17327.59	16511.51	17444.21	
High Screen¹ - Integrated Table Painted MDF															
Painted MDF	None	S9F	-H	2-	P1	\$ 9197.76	\$ 9446.48	\$ 9586.37	\$ 9850.62	\$ 10037.18	\$ 10899.91	\$ 11412.87	\$ 12337.76	\$ 11521.68	\$ 12454.38
Painted MDF	S9F	-H	2-	P3	9842.85	10091.57	10231.46	10495.71	10682.27	11545.00	12057.96	12982.85	12166.77	13099.47	
Plank White Oak	S9F	-H	2-	P4	11622.73	11871.45	12011.34	12275.59	12462.15	13324.88	13837.84	14762.73	13946.65	14879.35	
Plank Walnut	S9F	-H	2-	P4	11723.77	11972.49	12112.38	12376.63	12563.19	13425.92	13938.88	14863.77	14047.69	14980.39	
Plank White Oak	None	S9F	-H	2-	P2	\$ 11319.59	\$ 11568.31	\$ 11708.20	\$ 11972.45	\$ 12159.01	\$ 13021.74	\$ 13534.70	\$ 14459.59	\$ 13643.51	\$ 14576.21
Painted MDF	S9F	-H	2-	P5	11964.68	12213.40	12353.29	12617.54	12804.10	13666.83	14179.79	15104.68	14288.60	15221.30	
Plank White Oak	S9F	-H	2-	P6	13744.56	13993.28	14133.17	14397.42	14583.98	15446.71	15959.67	16884.56	16068.48	17001.18	
Plank Walnut	S9F	-H	2-	P6	13845.60	14094.32	14234.21	14498.46	14685.02	15547.75	16060.71	16985.60	16169.52	17102.22	
Plank Walnut	None	S9F	-H	2-	P2	\$ 12306.67	\$ 12555.39	\$ 12695.28	\$ 12959.53	\$ 13146.09	\$ 14008.82	\$ 14521.78	\$ 15446.67	\$ 14630.59	\$ 15563.29
Painted MDF	S9F	-H	2-	P5	12951.76	13200.48	13340.37	13604.62	13791.18	14653.91	15166.87	16091.76	15275.68	16208.38	
Plank White Oak	S9F	-H	2-	P6	14731.64	14980.36	15120.25	15384.50	15571.06	16433.79	16946.75	17871.64	17055.56	17988.26	
Plank Walnut	S9F	-H	2-	P6	14832.68	15081.40	15221.29	15485.54	15672.10	16534.83	17047.79	17972.68	17156.60	18089.30	
High Screen¹ - Integrated Table Plank White Oak															
Painted MDF	None	S9F	-H	2-	W1	\$ 10721.16	\$ 10969.88	\$ 11109.77	\$ 11374.02	\$ 11560.58	\$ 12423.31	\$ 12936.27	\$ 13861.16	\$ 13045.08	\$ 13977.78
Painted MDF	S9F	-H	2-	W3	11366.25	11614.97	11754.86	12019.11	12205.67	13068.40	13581.36	14506.25	13690.17	14622.87	
Plank White Oak	S9F	-H	2-	W4	13146.13	13394.85	13534.74	13798.99	13985.55	14848.28	15361.24	16286.13	15470.05	16402.75	
Plank Walnut	S9F	-H	2-	W4	13247.17	13495.89	13635.78	13900.03	14086.59	14949.32	15462.28	16387.17	15571.09	16503.79	
Plank White Oak	None	S9F	-H	2-	W2	\$ 12842.99	\$ 13091.71	\$ 13231.60	\$ 13495.85	\$ 13682.41	\$ 14545.14	\$ 15058.10	\$ 15982.99	\$ 15166.91	\$ 16099.61
Painted MDF	S9F	-H	2-	W5	13488.08	13736.80	13876.69	14140.94	14327.50	15190.23	15703.19	16628.08	15812.00	16744.70	
Plank White Oak	S9F	-H	2-	W6	15267.96	15516.68	15656.57	15920.82	16107.38	16970.11	17483.07	18407.96	17591.88	18524.58	
Plank Walnut	S9F	-H	2-	W6	15369.00	15617.72	15757.61	16021.86	16208.42	17071.15	17584.11	18509.00	17692.92	18625.62	
Plank Walnut	None	S9F	-H	2-	W2	\$ 13830.07	\$ 14078.79	\$ 14218.68	\$ 14482.93	\$ 14669.49	\$ 15532.22	\$ 16045.18	\$ 16970.07	\$ 16153.99	\$ 17086.69
Painted MDF	S9F	-H	2-	W5	14475.16	14723.88	14863.77	15128.02	15314.58	16177.31	16690.27	17615.16	16799.08	17731.78	
Plank White Oak	S9F	-H	2-	W6	16255.04	16503.76	16643.65	16907.90	17094.46	17957.19	18470.15	19395.04	18578.96	19511.66	
Plank Walnut	S9F	-H	2-	W6	16356.08	16604.80	16744.69	17008.94	17195.50	18058.23	18571.19	19496.08	18680.00	19612.70	
High Screen¹ - Integrated Table Plank Walnut															
Painted MDF	None	S9F	-H	2-	W1	\$ 10853.26	\$ 11101.98	\$ 11241.87	\$ 11506.12	\$ 11692.68	\$ 12555.41	\$ 13068.37	\$ 13993.26	\$ 13177.18	\$ 14109.88
Painted MDF	S9F	-H	2-	W3	11498.35	11747.07	11886.96	12151.21	12337.77	13200.50	13713.46	14638.35	13822.27	14754.97	
Plank White Oak	S9F	-H	2-	W4	13278.23	13526.95	13666.84	13931.09	14117.65	14980.38	15493.34	16418.23	15602.15	16534.85	
Plank Walnut	S9F	-H	2-	W4	13379.27	13627.99	13767.88	14032.13	14218.69	15081.42	15594.38	16519.27	15703.19	16635.89	
Plank White Oak	None	S9F	-H	2-	W2	\$ 12975.09	\$ 13223.81	\$ 13363.70	\$ 13627.95	\$ 13814.51	\$ 14677.24	\$ 15190.20	\$ 16115.09	\$ 15299.01	\$ 16231.71
Painted MDF	S9F	-H	2-	W5	13620.18	13868.90	14008.79	14273.04	14459.60	15322.33	15835.29	16760.18	15944.10	16876.80	
Plank White Oak	S9F	-H	2-	W6	15400.06	15648.78	15788.67	16052.92	16239.48	17102.21	17615.17	18540.06	17723.98	18656.68	
Plank Walnut	S9F	-H	2-	W6	15501.10	15749.82	15889.71	16153.96	16340.52	17203.25	17716.21	18641.10	17825.02	18757.72	
Plank Walnut	None	S9F	-H	2-	W2	\$ 13962.17	\$ 14210.89	\$ 14350.78	\$ 14615.03	\$ 14801.59	\$ 15664.32	\$ 16177.28	\$ 17102.17	\$ 16286.09	\$ 17218.79
Painted MDF	S9F	-H	2-	W5	14607.26	14855.98	14995.87	15260.12	15446.68	16309.41	16822.37	17747.26	16931.18	17863.88	
Plank White Oak	S9F	-H	2-	W6	16387.14	16635.86	16775.75	17040.00	17226.56	18089.29	18602.25	19527.14	18711.06	19643.76	
Plank Walnut	S9F	-H	2-	W6	16488.18	16736.90	16876.79	17141.04	17327.60	18190.33	18703.29	19628.18	18812.10	19744.80	

¹Pricing shown for Low and High Screen reflects screen Grade A pricing. Reference chart for upcharge amounts for higher grade pricing.

Description	A	B	C	D	E	F	G	H
Low Screen (2) 30" x 21"	N/A	\$466.34	\$715.05	\$1212.48	\$1570.01	\$3171.11	\$4134.87	\$5860.32
High Screen (2) 30" x 21"	N/A	\$466.34	\$715.05	\$1212.48	\$1570.01	\$3171.11	\$4134.87	\$5860.32

The following option requires modification of the product number.

Stain repellent To specify, add **P** to the end of the product number (add **\$116.59** to list); **Example:** S9FR-L22-001HP
(not applicable to screens)

Lounge Island

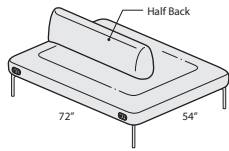

SSGK-2_OH

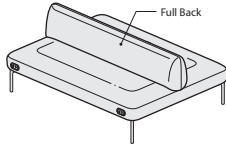

SSGB-2_OH

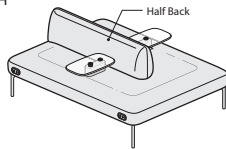

SSGK-2_PH

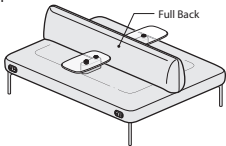

SSGB-2_PH

Class CB

Features

- Includes Island sofa on four legs. Sofa can be specified with half-back, full-back, integrated table and embedded power.
- Embedded Power available in two options:
 - Power - Two Power Receptacles (NEMA-5-15R) per location.
 - Power + USB - One Power Receptacle (NEMA-5-15R) and one Dual USB A-C (20W shared between A and C).
- Power is embedded on Island mirrored (two power) or on all four corners (four power). Refer to specification guide for visual reference of power location. When two power locations are ordered:
- Half-back Island will have power mirrored on the half-back side of the sofa.
- Full-Back Island will have power mirrored on one side of the sofa.
- Power housing is available in supplier Black or White and has 10'(3048mm) black cord.
- Integrated table option available on half-back or full-back Island and will be located on both sides of the unit.
- Integrated table is 0.75"(19mm) thick and 20"(508mm)D x 11"(279mm)W mounted on a 3.5"(89mm)H stanchion.
- Legs are painted cast aluminum.
- Glides are black plastic with 0.5"(13mm) leveling adjustment.
- COM yardage:
 - Half-Back: 7.0
 - Full-Back: 8.0

Specification Tips

- Gangs with other Cabana Lounge Island units using separately specified Ganging Bracket.
- Fabric applied railroaded.
- Linear or patterned fabric not recommended due to the way the material is applied.
- Embedded Power is factory installed and cannot be field installed. Power type can be field modified with service parts.
- **For use with 120 volt 60 hertz electrical system only.**
- Place powered seating within 4'(1219mm) of power source.
- Integrated table is factory installed. The table position is fixed and cannot be field modified.
- The integrated table is designed to work with separately specified, field installed, Bezel Utility Module EURT-00_-. Table stanchion allows cord management through the seat. Bezel Utility Modules ship standard with 6'(1829mm) or 12'(3658mm) cord lengths.

Dimensions

Height:	Depth:	Width:
30.5"(775mm)	54"(1372mm)	72"(1829mm)
*SH: 17.3"(439mm)	*SD: 21.125"(537mm)	SW: 72"(1829mm)
	on each side	

*Measurements taken with the BIFMA chair measuring device.

To Order, Specify:

1) Product number, including:

1 Power Option:

O None

Power

1 Two Power - Black (add **\$709.43** list)

A Two Power - White (add **\$709.43** list)

3 Four Power - Black (add **\$1418.89** list)

C Four Power - White (add **\$1418.89** list)

Power + USB

4 Two Power + USB - Black (add **\$897.89** list)

D Two Power + USB - White (add **\$897.89** list)

6 Four Power + USB - Black (add **\$1795.76** list)

F Four Power + USB - White (add **\$1795.76** list)

- 2) Seat and back material.
- 3) Table finish (if applicable).
- 4) Leg color.

Lounge Island

Description	Number ①	Seat & Back Fabric							
		A	B	C	D	E	F	G	H
No Integrated Table									
Half Back	S9GK-2 -OH	\$ 7619.95	\$ 7886.66	\$ 8399.29	\$ 8735.27	\$ 10351.28	\$ 11386.41	\$13094.37	\$14403.82
Full Back	S9GB-2 -OH	8347.47	8639.60	9201.18	9569.24	11339.54	12473.48	14344.53	15778.98
Integrated Table - Painted MDF									
Half Back	S9GK-2 -PH	\$ 10138.92	\$10405.63	\$ 10918.26	\$ 11254.24	\$ 12870.25	\$13905.38	\$ 15613.34	\$ 16922.79
Full Back	S9GB-2 -PH	10866.44	11158.57	11720.15	12088.21	13858.51	14992.45	16863.50	18297.95
Integrated Table - Plank White Oak									
Half Back	S9GK-2 -WH	\$ 13189.24	\$13455.95	\$13968.58	\$14304.56	\$15920.57	\$16955.70	\$18663.66	\$ 19973.11
Full Back	S9GB-2 -WH	13916.76	14208.89	14770.47	15138.53	16908.83	18042.77	19913.82	21348.27
Integrated Table - Plank Walnut									
Half Back	S9GK-2 -WH	\$13464.75	\$ 13731.46	\$14244.09	\$14580.07	\$ 16196.08	\$ 17231.21	\$18939.17	\$20248.62
Full Back	S9GB-2 -WH	14192.27	14484.40	15045.98	15414.04	17184.34	18318.28	20189.33	21623.78

The following option requires modification of the product number.

Stain repellent

To specify, add **P** to the end of the product number. (Half-Back add **\$217.62** list, Full-Back add **\$248.72** list);

Example: S9GK-20-OHP.

Lounge Island Screen and Ganging Bracket

Island Screen

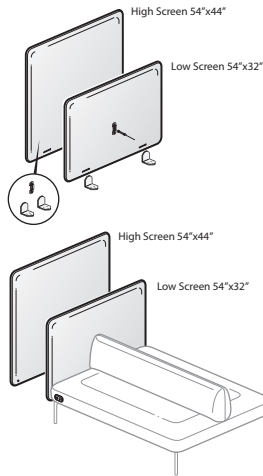

S9GS-L2
S9GS-H2
Class CB

Features

- Includes one screen and attachment hardware.
- COM yardage: Low: 3.5/N/A High: 3.75/N/A

Specification Tips

- Designed to provide privacy on one or both sides of the Island.
- For use with Cabana Lounge Island only.
- Screen must be attached to a Cabana Lounge Island back for stability. This will require drilling a hole into the side edge of the island back for bracket attachment.

To Order, Specify:

- 1) Product number.
- 2) Fabric color.

Description	Height from Floor	Width	Number	Fabric							
				A	B	C	D	E	F	G	H
Low	42"(1067mm)	54"(1372mm)	S9GS-L2	\$2448.28	\$2712.54	\$2860.21	\$3147.78	\$3342.12	\$4259.23	\$4811.06	\$5798.15
High	54"(1372mm)	54"(1372mm)	S9GS-H2	2448.28	2712.54	2860.21	3147.78	3342.12	4259.23	4811.06	5798.15

Island Screen Ganging Bracket

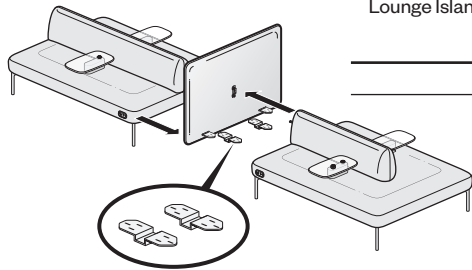

S9G-A0
Class CB

Features

- Includes two brackets and screws.
- Used to gang Cabana Lounge Island with screen to a second Cabana Lounge Island.

To Order, Specify:

- 1) Product number.(No finish specification required.)

Number	Price
S9G-A0	\$354.42

Accessories

Ganging Bracket

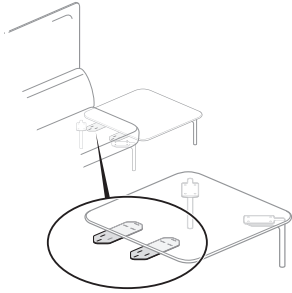

S9G-00
Class CB

Features

- Includes two brackets and screws.
- Used to gang seating unit to seating unit or seating unit to table.
- Black only.

Specification Tips

- When ganging with screens, use Ganging Kit S9G-10.
- Remove table legs when ganging tables to seating.

To Order, Specify:

- 1) Product number.
(No finish specification required.)

Number	Price
S9G-00	\$225.41

Ganging Bracket

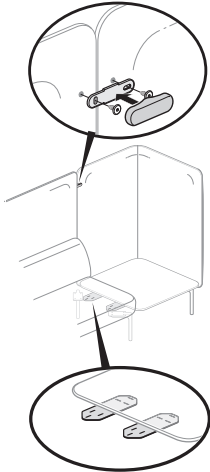

S9G-10
Class CB

Features

- Includes two ganging brackets, one screen alignment clip with cover and hardware.
- Ganging bracket used to gang seating unit to seating unit or seating unit to table.
- Ganging brackets available in black only.
- Screen alignment clip used to connect two screens together.
- Screen alignment clip available in trim colors.

Specification Tips

- Ganging kit used to gang Cabana seating with screen to other Cabana seating or tables with a screen.
- Remove table legs when ganging tables to seating.
- Screen accessories should not hang on screen intersection or screen alignment clip.

To Order, Specify:

- 1) Product number.
- 2) Screen alignment clip trim color.

Number	Price
S9G-10	\$248.72

Accessories

Shelf

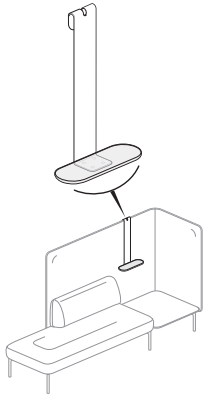

S9SL
Class CB

Features

- Includes one painted MDF or planked wood shelf and one painted steel shelf hook.
- Shelf hook hangs over top of a Cabana screen.
- Maximum weight load is 5 lbs. centered.

Specification Tips

- Best used on High Screens or placed over a table.
- Do not use on a screen intersection or screen alignment clip.

To Order, Specify:

- 1) Product number.
- 2) Shelf material/color.
- 3) Trim color.

Description	Height	Depth	Width	Number	Price
Painted MDF	18"(457mm)	4"(102mm)	12"(305mm)	S9SL-PO	\$ 652.86
Plank White Oak				S9SL-WO	2036.34
Plank Walnut				S9SL-WO	2222.87

Coat Hook

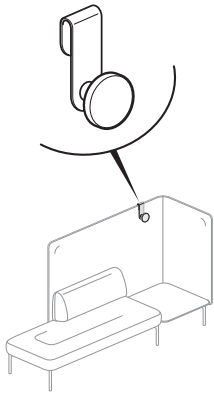

HOCH-0000
Class QA

Features

- Includes one painted steel bracket and wood white oak disk hook.
- Maximum weight load is 10 lbs.

Specification Tips

- When used in a Cabana application the Coat Hook is best used on High Screens, on outside of screen or placed over a table.
- Do not use on a screen intersection or screen alignment clip.

To Order, Specify:

- 1) Product number.
- 2) Trim color.

Height	Depth	Width	Number	Price
7.7"(178mm)	1.6"(25mm)	3"(76mm)	HOCH-0000	\$278.24

Accessories

Connector Screen

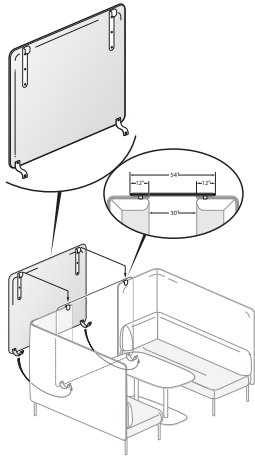

S9SH-20
Class CB

Features

- Includes one connector screen with hanging brackets.
- Available in one height only. Height designed to match height of High Screen.
- Designed to connect two sofas with high screens together to form a booth application.
- Hanging brackets shipped installed.
- COM yardage: 3.5

Specification Tip

- Recommend connected seating be placed 30"(762mm) apart.

To Order, Specify:

- 1) Product number.
- 2) Screen material.
- 3) Bracket color.

Height from Floor	Depth	Width	Number	Fabric							
				A	B	C	D	E	F	G	H
54"(1372mm)	2"(51mm)	54"(1372mm)	S9SH-20	\$2448.28	\$2914.62	\$3171.12	\$3668.54	\$4018.29	5619.39	\$6583.13	\$8308.58

Shelf with Monitor Mount

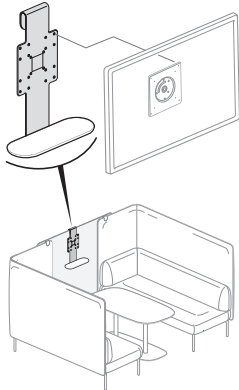

S9SP
S9SW
Class CB

Features

- Includes one painted MDF or planked wood shelf, one painted steel shelf hook and one monitor mount.
- Shelf hook hangs over top of a Cabana Lounge Connector Screen.
- Maximum weight load is 40 lbs.
- Maximum monitor size is 32"(813mm).

Specification Tip

- Designed for use on Cabana Lounge Connector Screen only.

To Order, Specify:

- 1) Product number.
- 2) Wood or paint finish.
- 3) Trim color.

Description	Height	Depth	Width	Number	Price
Painted MDF	18"(457mm)	4"(102mm)	12"(305mm)	S9SP-MO	\$ 707.28
Plank White Oak				S9SW-MO	\$2090.76
Plank Walnut				S9SW-MO	\$ 2277.29

Bezel Utility Module

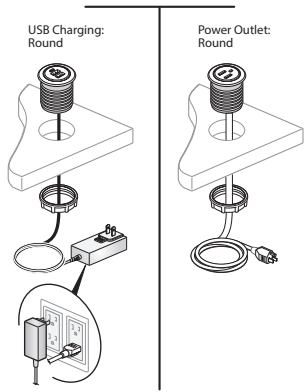

EURT-0072-1100
EURT-0072-1010
Class CB



Features

- Includes: Round faced Power Module and mounting hardware.
- For use on surfaces 0.75" (19mm) - 1.44" (37mm) thick.
- Available with either:
 - One power outlet (NEMA 5-15R)
 - One two port USB charger. Consists of two USB outlets with 1000mA of charging power (5 volts) per USB outlet.
- Available in black or supplier white only.

Specification Tips

- **For use with 120 volt 60 hertz power source only.**
- Power configuration has one cord with plug (NEMA 5-15P).
- USB configuration has one cord with 2" (51mm) x 1" (25mm) x 3" (76mm) voltage transformer plug. Transformer may block adjacent outlets (see illustration).
- Requires field cut 1.75" (44mm) hole and field installation.
- Application may require approval of local authority having jurisdiction (AHJ); ensure compliance before placing orders and installing.

To Order, Specify:

1) Product number, including:

1 Color Options:

B Black

W White

Description	Depth	Number	1	Price
6' Cord				
Power	1.75" (44mm)	EURT-0072-1100C		\$ 132.85
USB		EURT-0072-1010C		398.58
12' Cord				
Power	1.75" (44mm)	EURT-00E4-1100C		\$ 227.75
USB		EURT-00E4-1010C		493.48

Data Bezel

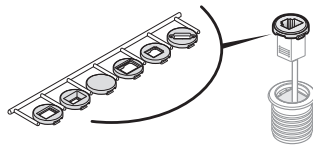

EURT-0000-N001CB
EURT-0000-N001CW
Class QA

Feature

- Includes one round bezel for the Bezel Utility Module.
- Available in black or supplier white only.

To Order, Specify:

1) Product number.
(No finish specification required.)

Description	Number	Price
Round		
Black	EURT-0000-N001CB	\$132.85
White	EURT-0000-N001CW	132.85

Cabana Lounge Resources

Surfaces Materials

Index

Warranty

Surface Materials

Finish Color Legend

Wood

Grade A

Double Cut

CQ-HKL	Auburn
CQ-HBF	Clove
WE-RD	Dune
WJ-RE	Ebony
2N-RL	Echo
W3-HR	Harbor
WE-RT	Melba
W4-PB	Pebble
CQ-WG	Walnut Grove

Grade B

Cherry

VC-CA1	Amber
VC-W23	American
VC-HKF	Burgundy
VC-W33	Caramel
VC-W30	Heritage
VC-W32	Pacific
VC-HKA	Toffee

Maple

VP-LM	Light
VP-N	Natural

Maple Quarter Cut

NM-N	Natural
------	---------

Oak

VJ-HKC	Urban
--------	-------

Walnut

VR-CPK	Bourbon
VR-HKG	Columbian
VR-W15	Espresso
VR-W31	Retro

Walnut Quarter Cut

NW-W35	Clear
NW-W31	Retro

White Oak Rift Cut

NR-W35	Clear
NR-W15	Espresso
NR-W40	Mocha

HPL

Grade A

Solid Color

H-34	Beige
H-AK	Chalk
H-8J	Charcoal
H-3J	Graphite
H-62	Gray Tone
H-WL	Linen
H-3P	Platinum
H-AA	Putty
H-3E	Smoke

Patterned

H-P1	Linen Casual
H-P2	Linen Classic
H-P3	Linen Crisp
H-P4	Linen Flax

Wood Grain

H-B06	Brazilwood
H-E79	Colombian Walnut
H-AE	Maple
H-DYP	New Age Oak
H-E15	River Cherry
H-C09	Williamsburg Cherry

Grade B

Premium Wood Grain

H-C8	Blonde Modern Cherry
H-D1	Daintree
H-KP	Field Elm
H-KN	Grey Elm
H-KM	Landmark Wood
H-D2	Mocha Modern Cherry
H-KL	Neo Walnut
H-KR	Phantom Ecu
H-LS	Phantom Pearl
H-C9	Spiced Modern Cherry

Edgeband

Solid Color

HP-34	Beige
HP-AK	Chalk
HP-8J	Charcoal
HP-3J	Graphite
HP-62	Gray Tone
HP-WL	Linen
HP-3P	Platinum
HP-AA	Putty
HP-3E	Smoke

Patterned

HP-P1	Linen Casual
HP-P2	Linen Classic
HP-P3	Linen Crisp
HP-P4	Linen Flax

Wood Grain

HP-C8	Blonde Modern Cherry
HP-B06	Brazilwood
HP-E79	Colombian Walnut
HP-D1	Daintree
HP-KP	Field Elm
HP-KN	Grey Elm
HP-KM	Landmark Wood
HP-AE	Maple
HP-D2	Mocha Modern Cherry
HP-KL	Neo Walnut
HP-DYP	New Age Oak
HP-KR	Phantom Ecu
HP-LS	Phantom Pearl
HP-E15	River Cherry
HP-C9	Spiced Modern Cherry
HP-C09	Williamsburg Cherry

Ply-Edge

HP-PW	Ply-Edge
-------	----------

Trim

TR-F	Black
TR-M1	Black Matte
TR-RR	Rusty Red
TR-1M	Sable
TR-PLS	Smooth Plaster
TR-M2	Smooth Plaster Matte

Painted MDF

PW-F	Black
PW-AK	Chalk
PW-PL	Polar

Planked Wood

VB-W35	Plank White Oak
VH-W35	Plank Walnut

* For most current finish and fabric availability please reference surfaces.haworth.com.

ALERT: These materials are current, however they are being considered for future obsolescence due to low volume.

Wood	
VJ-W42	Brindle
2R-RL	Butternut
NW-W15	Espresso
NP-W08	Golden
NP-W07	Light
NX-U	Medium
VR-W12	Naturally Walnut
WC-RW	Wenge

HPL	
H-AM	Amber Cherry
H-AD	Medium Cherry

Edgeband	
HP-AM	Amber Cherry
HP-AD	Medium Cherry

Surface Materials

Fabrics/Color Legend

Seating Fabrics

Grade A	
(4H)	Blanket
(3J)	Hobson
(4J)	Morse
(3L)	Novelty
(XJ)	Wellington
Grade B	
(4Z)	Element
(4V)	Ramie
Grade C	
(6K)	Dots
(67)	King II
(68)	Maya II
(4T)	Oceanic
(3S)	Scapes
Grade D	
(LW)	Atlas by Kvadrat
(4D)	Big Arrow
(1K)	Big Diagonale
(NV)	Clara 2 by Kvadrat
(66)	Class II
(6M)	Main Line Flax
(S7)	Melange Nap by Kvadrat
Grade F	
(SV)	Divina Melange 3 by Kvadrat
(SZ)	Hallingdal 65 by Kvadrat

Screen Fabrics

Grade A	
(4H)	Blanket
(3J)	Hobson
(3L)	Novelty
Grade B	
(4Z)	Element
(4V)	Ramie
Grade C	
(6K)	Dots
(67)	King II
(68)	Maya II
(4T)	Oceanic
(3S)	Scapes
Grade D	
(LW)	Atlas by Kvadrat
(4D)	Big Arrow
(1K)	Big Diagonale
(NV)	Clara 2 by Kvadrat
(66)	Class II
(6M)	Main Line Flax
(S7)	Melange Nap by Kvadrat
Grade F	
(SV)	Divina Melange 3 by Kvadrat
(SZ)	Hallingdal 65 by Kvadrat

* For most current finish and fabric availability please reference surfaces.haworth.com.

Haworth+

For information on the Haworth+ alliance program, including images and product availability, please refer to: [Haworth.com](https://www.haworth.com) > Surface Collection > Haworth+ Library

Customer's Own Material (COM)

For general Customer's Own Material (COM) information including processes and forms, please refer to:

[Haworth.com](https://www.haworth.com) > Surface Collection > Resources > COM

For information on approved COM's, please refer to:

[Haworth.com](https://www.haworth.com) > Surface Collection > COM Library

Forestry Stewardship Council (FSC) Statement:

In our continuing support of sustainable forestry and responsible purchasing, Haworth North America is offering FSC certified wood products at no up-charge. By providing FSC certified material, Haworth is supporting our client's green building goals and demonstrating our collective commitment to source materials more sustainably. Haworth will provide to you the necessary FSC-certified paperwork with your shipment. For more information, FAQs, and a complete FSC product list (including product exceptions), go to the Library and search FSC.

COM Yardage Requirements

Procedure

To determine if a COM fabric has been approved for use on Haworth product, contact Haworth (1.800.426.8562), your local Haworth dealer, or go to surfaces.haworth.com. Haworth will calculate and order fabric unless instructed otherwise. If the fabric is approved, and the directional orientation (directional rightway, directional railroad, or non-directional) of the tested fabric has been confirmed, then refer to the appropriate price page for yardage requirements.

COM Fabric Requirements

The fabric yardage requirements for COMs given for each model are in lineal yards and are based on 54" (1372mm) usable fabric widths. Approximate yardage requirements are shown for each model within the price pages.

For fabrics already approved, with a COM order entry code assigned, Haworth will determine and purchase the yardage needed. If the fabric will be provided by the dealer, and the pattern has a large repeat or stripes, additional yardage will be needed; contact the COM Department for more information.

Find total number of linear yards required for the order. Add the appropriate percentage shown below to the total yardage to accommodate fabric flaws, wrinkles and other imperfections.

Up to 500 yards	Add 10%
501 to 1000 yards	Add 5%
More than 1000 yards	Add 3%

Directional Rightway:

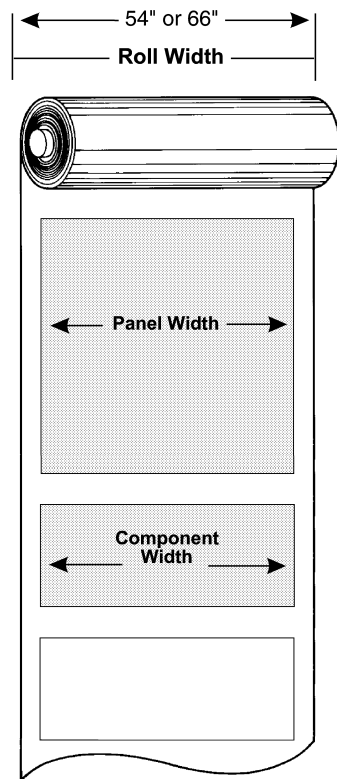

Directional Railroad:

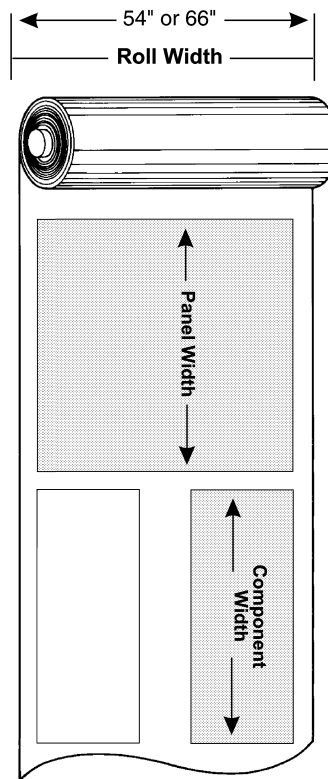

Non-Directional:

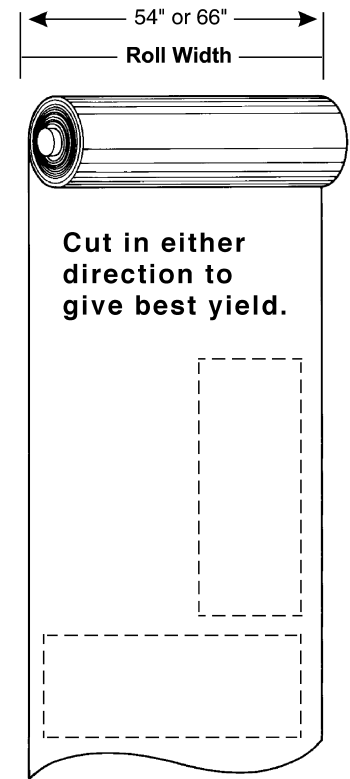

Index

Products are listed alphabetically in this index by alpha-numeric prefix/suffix codes.

Product Code	Product Description	Page
EURT-0000-N001CB	Bezel Utility Module – Data Bezel	42
EURT-0000-N001CW	Bezel Utility Module – Data Bezel	42
EURT-0072-1010	Bezel Utility Module	42
EURT-0072-1100	Bezel Utility Module	42
HOCH-0000	Accessories – Coat Hook	40
S910	Tables – Square	22
S914	Tables – Square	22
S920	Tables – Square Tiered	23
S924	Tables – Square Tiered	23
S930	Tables – Rectangle	25
S934	Tables – Rectangle	25
S940	Tables – Rectangle Tiered	26
S944	Tables – Rectangle Tiered	26
S950	Tables – Wedge	28
S956	Tables – Wedge	28
S960	Tables – Wedge Tiered	29
S966	Tables – Wedge Tiered	29
S9AL-0	Corner Sofa	14
S9AL-H	Corner Sofa	14
S9AL-L	Corner Sofa	14
S9B0-0	Single Seat Sofa	15
S9BB-0	Single Seat Sofa	15
S9BL-0	Single Seat Sofa	15
S9BL-L	Single Seat Sofa	15
S9BR-0	Single Seat Sofa	15
S9BR-H	Single Seat Sofa	15
S9C0-0	Two-Seat Collaborative Sofa	17
S9C2-0	Two-Seat Collaborative Sofa	17
S9CB-0	Two-Seat Collaborative Sofa	17
S9CB-0	Two-Seat Collaborative Sofa	17
S9CH-0	Two-Seat Collaborative Sofa	17
S9CL-0	Two-Seat Collaborative Sofa	17
S9CL-0	Two-Seat Collaborative Sofa	17
S9CL-L	Two-Seat Collaborative Sofa	17
S9CR-0	Two-Seat Collaborative Sofa	17
S9CR-H	Two-Seat Collaborative Sofa	17
S9CZ-0	Two-Seat Collaborative Sofa	17
S9DC-0	Chaise Lounge	20
S9DC-H	Chaise Lounge	20
S9DT-0	Chaise Lounge	20
S9DT-L	Chaise Lounge	20
S9EL	Chaise Lounge Retreat	31
S9F	Half-Back Sofa Retreat	33
S9G-00	Accessories – Ganging Bracket	39
S9G-10	Accessories – Ganging Bracket	39
S9G-A0	Lounge Island Screen Ganging Bracket – Island Screen Ganging Bracket	38
S9GB-2_OH	Lounge Island	36
S9GB-2_PH	Lounge Island	36
S9GK-2_OH	Lounge Island	36
S9GK-2_PH	Lounge Island	36
S9GS-H2	Lounge Island Screen and Ganging Bracket – Island Screen	38

Index

<u>Product Code</u>	<u>Product Description</u>	<u>Page</u>
S9GS-L2	Lounge Island Screen and Ganging Bracket – Island Screen38
S9L2-0	Individual Lounge13
S9L2-H	Individual Lounge13
S9L2-L	Individual Lounge13
S9SH-20	Accessories – Connector Screen41
S9SL	Accessories – Shelf40
S9SP	Accessories – Shelf with Monitor Mount41
S9SW	Accessories – Shelf with Monitor Mount41

Product Compatibility and Limited Warranty Policy

Great Expectations

You have them as a Haworth customer and so do we. And because we value our customers, we cover our products with the Haworth North America Product Compatibility and Limited Warranty Policy.

Our Commitment To Product Compatibility – Integrated Product Platforms

As a market leader in the design and manufacture of workspaces that adapt to change, we strive to maintain product compatibility within our various generations of integrated product platforms. This benefits the customer who desires to update or modify their work environment. It also benefits the customer needing to replace a product due to damage or other reasons but which is no longer manufactured or is otherwise unavailable, such as a fabric or finish that is discontinued because of changing market preferences. In both circumstances, we often can provide products with comparable function and performance.

Our Commitment To Product Quality – The Haworth North America Limited Warranty

To ensure customer satisfaction and peace of mind, we stand behind our products with the Haworth North America Limited Warranty. To review the current version of the limited warranty including its terms and conditions, please go to:

www.haworth.com/warranty or contact OneTouch@Haworth.com or 1 877 429 6784.

Warranty Requests or Questions

For questions or service requests pertaining to the Haworth Limited Warranty, please contact your Haworth dealer.

If you are unsure who your dealer is, please contact **OneTouch@Haworth.com or 1 877 429 6784.**

Terms of Sale

The Terms of Sale apply to all products in the North America Price Lists. To review the current version of the North American Terms of Sale, please go to:

www.haworth.com/terms-of-sale or contact OneTouch@Haworth.com or 1 877 429 6784.

HAWORTH

HAWORTH® is a registered trademark of Haworth, Inc.
© Haworth, Inc. All rights reserved. 2026 2.26
haworth.com | 800 344 2600