

Electrical Accessories

GSA Price List – February 2026



This price list is based upon Haworth's December 2025 commercial pricing.
GENERAL SERVICES ADMINISTRATION FEDERAL SUPPLY SERVICE
Authorized Federal Supply Scheduled Price List (Catalog) Office Furniture, Wood Casegoods and Tables
(FSC Group 71, Part I, FSC Classes 7105, 7110, 7125 and 7195)
Contract No: GS-O3F-057DA | Contract Period: February 28, 2026 – February 7, 2031 | Business: Large
Contractor: Haworth, Inc. | One Haworth Center | Holland, MI 49423-9576 | 1.616.393.3000





This Haworth North American price book contains US list prices.

Canadian customers can convert the US list price into their Canadian equivalent by going to www.Haworth.com/Canada to find the current Canadian multipliers. These multiplier factors allow you to convert the US list price into a Canadian list price.

HAWORTH, INC.

GENERAL SERVICES ADMINISTRATION

FEDERAL ACQUISITION SERVICES

Authorized Federal Supply Schedule Furniture (FSC Group 71, FSC Classes 7105, 7110, 7125 and 7195)

Contract Number:	GS-03F-057DA
Contract Start Date:	February 28, 2026
Contract End Date:	February 7, 2031
Contractor:	HAWORTH, INC. One Haworth Center Holland, MI 49423-9576 1-616-393-3000 http://www.haworth.com/government
Business Size:	Large

Information for Ordering Activities I-FSS-600

Online access to Haworth's Authorized Federal Supply Schedule contract ordering information, terms and conditions, and up-to-date product and discount listing can be found at GSA Advantage, eLibrary link [here](#).



This Page Intentionally Left Blank

Electrical Accessories Price List

Includes pricing, catalog numbers, finish codes/availability, specification requirements, line art, dimensions, and specification tips for Electrical Accessories.

Worksurface Power Modules

Worksurface Power Modules — Enhanced Power

Worksurface Power Modules — Classic Power

Worksurface Power Modules — Flip Top

Worksurface Power Modules — Flush Mounted Power

Worksurface Power Modules — Power Tap

Worksurface Power Modules — Other Power and Data

Cable Management — Horizontal

Cable Management — Vertical

Cable Management Accessories

Table of Contents

Price List

Statement of Line 7

Worksurface Power Modules

- Belong Power 65W — Power Cube 14
- Belong Power 65W — Plug Strip 14
- Belong Power 65W — Power Suite 15
- Belong Power 65W — Plug Strip Brackets 16
- Power Cube 17
- Belong — Plug Strip 17
- Belong — Power Suite 17
- Power Cube and Power Suite — Brackets 18
- Wireless Charging Module 19

Worksurface Power Modules — Enhanced Power

- Seamless 20
- Corded 23
- Hardwire 28
- Spiral Corded — Height Adjustable 33
- Cord for Height Adjustable 34
- Brackets — Above Worksurface — Adjustable 35
- Brackets — Above Worksurface — Adjustable for Knife Edge 35
- Brackets — Above Worksurface — Adjustable with Tackboard Offset 36
- Brackets — Above Worksurface — Fixed 36
- Brackets — Under Worksurface — Fixed 37
- Brackets — For Use with X Series 37

Worksurface Power Modules — Classic Power

- Classic Power Module 38
- Brackets — Angled 39
- Brackets — Vertical 39
- Brackets — Under Surface 39

Worksurface Power Modules — Flip Top

- Smooth Bezel — Corded — Single-Sided — Power, Data and USB .. 40
- Smooth Bezel — Corded — Double-Sided — Power, Data and USB .. 43
- Smooth Bezel — Hardwire — Single-Sided — Power, Data and USB .. 46
- Smooth Bezel — Hardwire — Double-Sided — Power, Data and USB .. 49
- Power and Data 52
- Non-Powered 53
- Corded — Single-Sided — Power, Data and USB 54
- Corded — Double-Sided — Power, Data and USB 59
- Hardwire — Single-Sided — Power, Data and USB 64
- Hardwire — Double-Sided — Power, Data and USB 69

Worksurface Power Modules — Flush Mounted Power

- Corded 74
- Hardwire 77
- Spiral Cord for Height Adjustable 80
- Cord for Height Adjustable 83
- Round 86

Worksurface Power Modules — Power Tap

- Horizontal 87
- Vertical 88
- Hardwire and Corded — Hardwire 89
- Hardwire and Corded — Corded 89
- Brackets — Fixed 90
- Brackets — Adjustable 90
- Brackets — Under Surface 90
- Brackets — Bracket with Grommet 90

Worksurface Power Modules — Other Power and Data

- Data Bezel 91
- Bezel Utility Module 91
- Collaborative Power Station 92
- Retrofit USB Charging Cable 93
- Cables 93

Cable Management — Horizontal

- Dual-Hinged Cable Management Tray — Application Chart 94
- Dual-Hinged Cable Management Tray — Metal 95
- Cable Management Basket — Metal 96
- Cover for Cable Management Basket — Metal 96
- Cable Management Channel — PET 96
- Fixed Cable Management Tray — Metal 96
- 72" J-Channel Cable Manager — Plastic 97
- 15" Mini J-Channel Cable Manager — Plastic 97

Cable Management — Vertical

- Cord Management Cuff 98
- Mesh Cord Manager with Cuffs 98
- Mesh Cord Manager Bracket 98
- Vertical Cord Manager — Metal 99
- Vertical Cable Guide 99
- Vertical Cord Manager — Plastic 99
- Height Adjustable Bench Cable Chain for Planes 99
- Height Adjustable Bench Cable Chain for Upside 99

Cable Management Accessories

- Conduit Clamp 100
- Cable Management Loop 100
- Cable Management Clips 100
- Belong Hatch 101
- Belong Hatch Planning Guidelines 102
- Grommets 103
- Grommets — Flip Top Unit — Hatch 104

Resources

Surface Materials

- Finish/Color Legend 106

Index

- 107-109

Lifetime Product Warranty

..... Inside Back Cover

Statement of Line

Worksurface Power Modules — Belong Power 65W

Pages 14-16

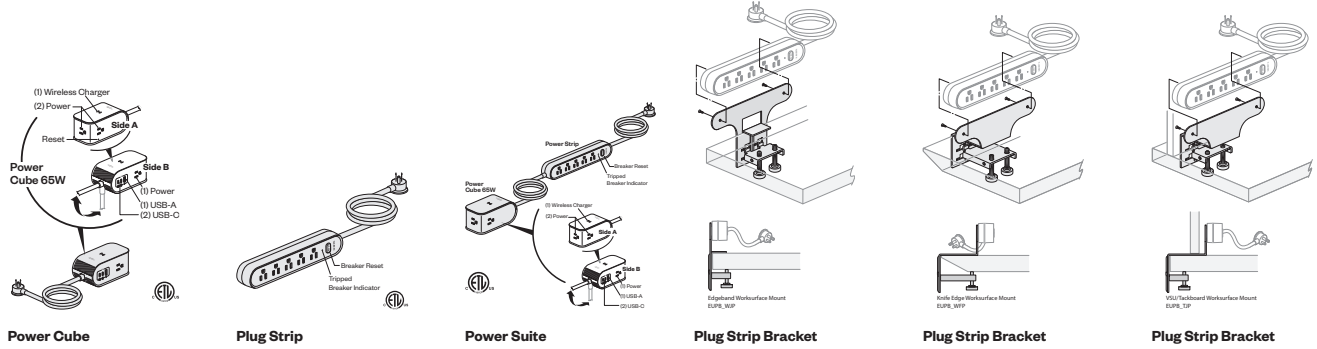

Worksurface Power Modules

Pages 17-19

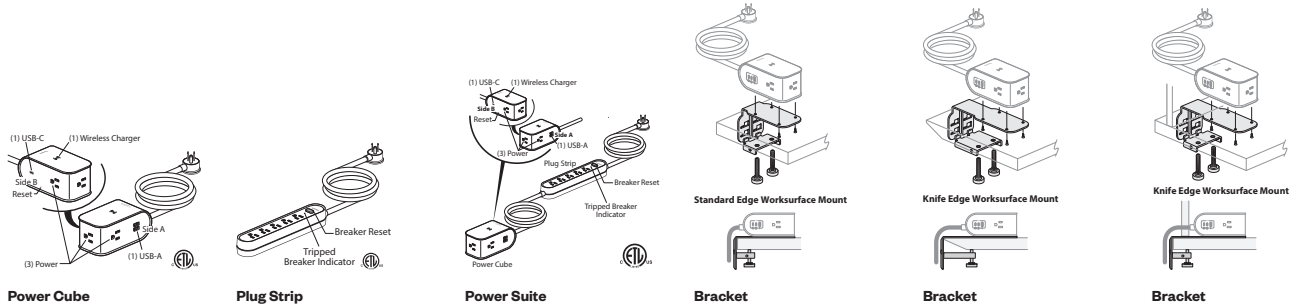

EUWC-PFOB-12002

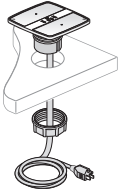

Wireless Charging Module

Worksurface Power Modules — Enhanced Power

Pages 20-37

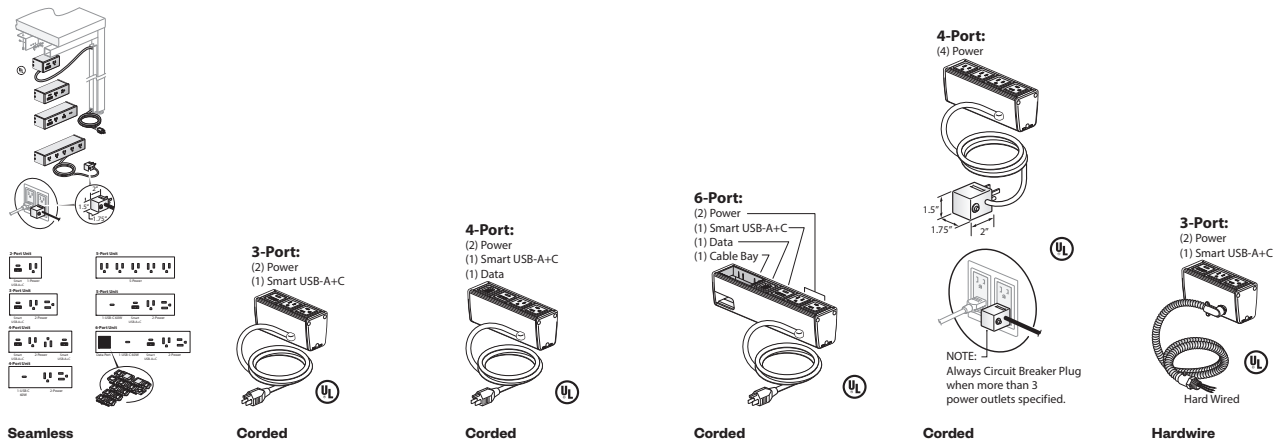

Statement of Line

Worksurface Power Modules — Enhanced Power, (cont'd)

Pages 20-37

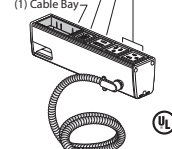
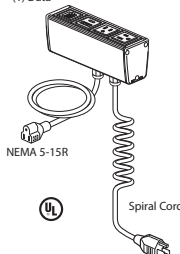
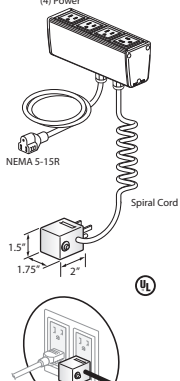
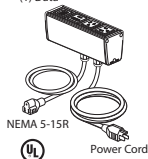
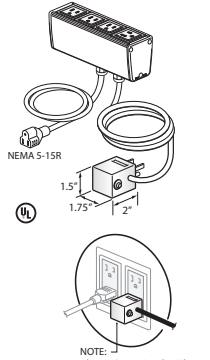
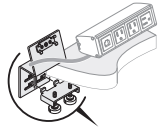
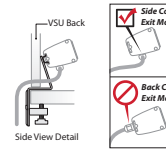
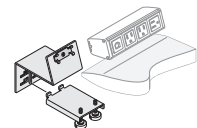
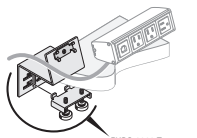
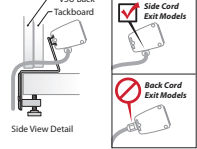
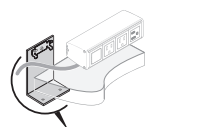
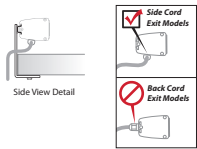
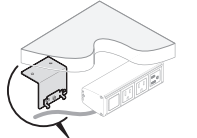
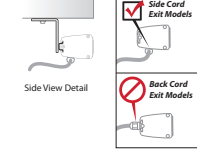
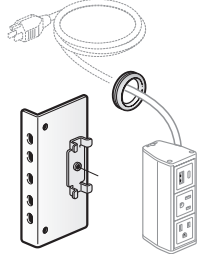
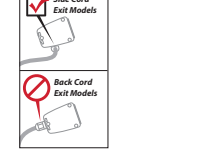
<p>4-Port: (2) Power (1) Smart USB-A+C (1) Data</p>  <p>Hard Wired</p>	<p>6-Port: (2) Power (1) Smart USB-A+C (1) Data (1) Cable Bay</p>  <p>Hard Wired</p>	<p>4-Port: (2) Power (1) Smart USB-A+C (1) Data</p>  <p>Spiral Cord</p>	<p>4-Port: (4) Power</p>  <p>Spiral Cord</p> <p>NOTE: Always Circuit Breaker Plug when more than 3 power outlets specified.</p>	<p>4-Port: (2) Power (1) Smart USB-A+C (1) Data</p>  <p>Power Cord</p>	<p>4-Port: (4) Power</p>  <p>NOTE: Always Circuit Breaker Plug when more than 3 power outlets specified.</p>
Hardwire	Hardwire	Spiral Corded Height Adjustable	Spiral Corded Height Adjustable	Cord for Height Adjustable	Cord for Height Adjustable
 <p>EUIDB-0000-H</p>  <p>Side View Detail</p>	 <p>EUIDB-0000-NB</p>	 <p>EUIDB-0000-T</p>  <p>Side View Detail</p>	 <p>EUIDB-0000-W</p>  <p>Side View Detail</p>	 <p>EUIDB-0000-U</p>  <p>Side View Detail</p>	 <p>EUIDB-J</p>  <p>Side View Detail</p>
Above Worksurface Adjustable Bracket	Above Worksurface Adjustable for Knife Edge Bracket	Above Worksurface Adjustable with Tackboard Offset Bracket	Above Worksurface Adjustable Fixed Bracket	Under Worksurface Fixed Bracket	For Use with X Series Bracket

Worksurface Power Modules — Classic Power

Pages 38-39

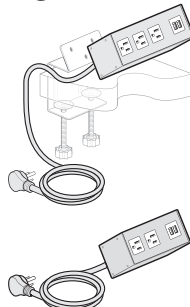
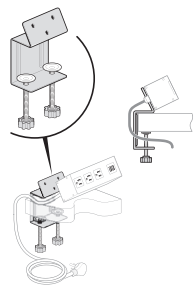
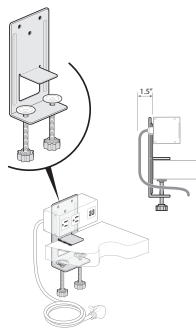
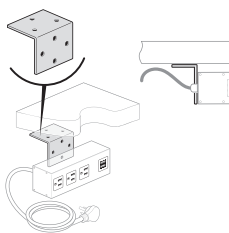
 <p>Classic Power Module</p>	 <p>Angled Bracket</p>	 <p>Vertical Bracket</p>	 <p>Under Surface Bracket</p>
---	---	---	---

Statement of Line

Worksurface Power Modules — Flip Top

Pages 40-73

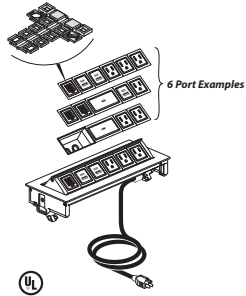

**Smooth Bezel
Corded
Single-Sided
Power, Data and USB**

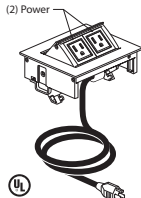

**Smooth Bezel
Corded
Single-Sided
Power, Data and USB**

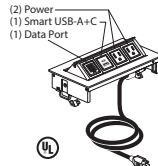

**Smooth Bezel
Corded
Single-Sided
Power, Data and USB**

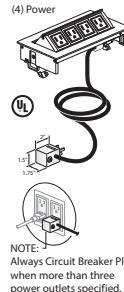

**Smooth Bezel
Corded
Single-Sided
Power, Data and USB**

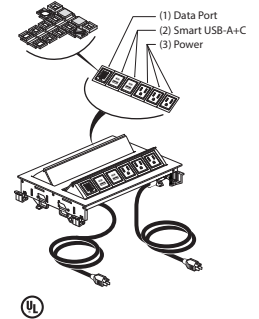

**Smooth Bezel
Corded
Double-Sided
Power, Data and USB**

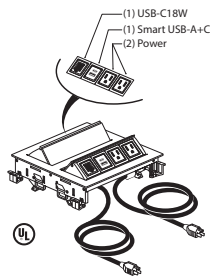

**Smooth Bezel
Corded
Double-Sided
Power, Data and USB**

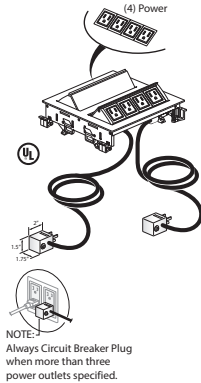

**Smooth Bezel
Corded
Double-Sided
Power, Data and USB**

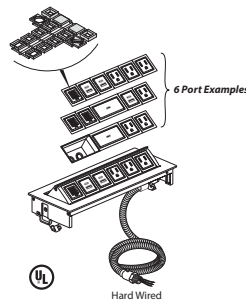

**Smooth Bezel
Hardwire
Single-Sided
Power, Data and USB**

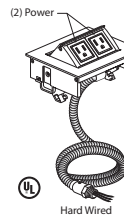

**Smooth Bezel
Hardwire
Single-Sided
Power, Data and USB**

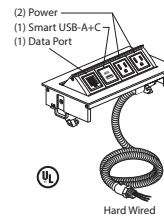

**Smooth Bezel
Hardwire
Single-Sided
Power, Data and USB**

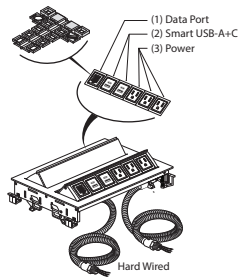

**Smooth Bezel
Hardwire
Double-Sided
Power, Data and USB**

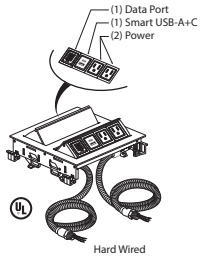

**Smooth Bezel
Hardwire
Double-Sided
Power, Data and USB**



Power and Data



Power and Data

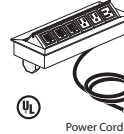

Power and Data

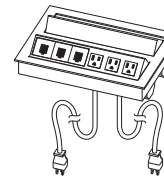

Power and Data

Statement of Line

Worksurface Power Modules — Flip Top, (cont'd)





Pages 40-73

<p>Power and Data</p>	<p>Power and Data</p>	<p>Power and Data</p>	<p>Non-Powered</p>	<p>Non-Powered</p>
<p>4-Port: (2) Power (1) Smart USB-A+C (1) Data</p>	<p>6-Port: (4) Power (1) Smart USB-A+C (1) Data</p> <p>NOTE: Always Circuit Breaker Plug when more than three power outlets specified.</p>	<p>4-Port: (4) Power</p> <p>NOTE: Always Circuit Breaker Plug when more than three power outlets specified.</p>	<p>(1) Data Port (1) Smart USB-A+C (3) Power</p>	<p>(2) Data Port (1) Smart USB-A+C (3) Power</p>
<p>Corded Single-Sided Power, Data and USB</p>	<p>Corded Single-Sided Power, Data and USB</p>	<p>Corded Single-Sided Power, Data and USB</p>	<p>Corded Double-Sided Power, Data and USB</p>	<p>Corded Double-Sided Power, Data and USB</p>
<p>(4) Power</p> <p>NOTE: Always Circuit Breaker Plug when more than three power outlets specified.</p>	<p>4-Port: (2) Power (1) Smart USB-A+C (1) Data</p>	<p>6-Port: (3) Power (1) Smart USB-A+C (2) Data</p>	<p>4 Port: (1) Data Port (1) Smart USB-A+C (2) Power</p>	<p>(2) Data Port (1) Smart USB-A+C (3) Power</p>
<p>Corded Double-Sided Power, Data and USB</p>	<p>Hardwire Single-Sided Power, Data and USB</p>	<p>Hardwire Single-Sided Power, Data and USB</p>	<p>Hardwire Double-Sided Power, Data and USB</p>	<p>Hardwire Double-Sided Power, Data and USB</p>

Statement of Line

Worksurface Power Modules — Flush Mounted Power

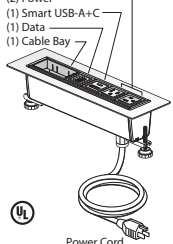
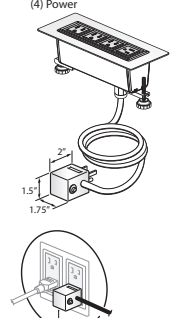
Pages 74-86

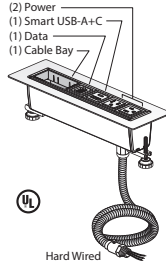
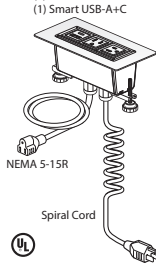
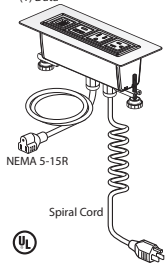
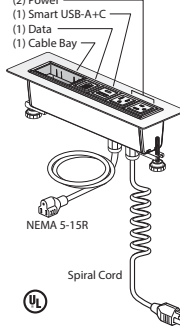
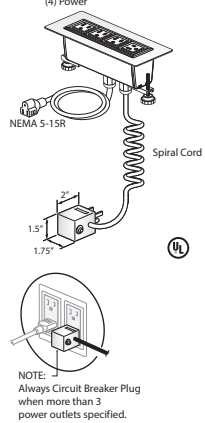
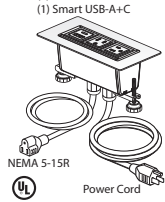
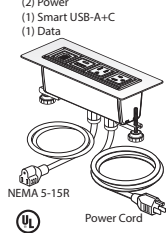
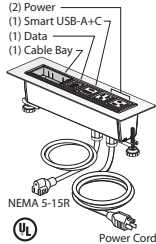
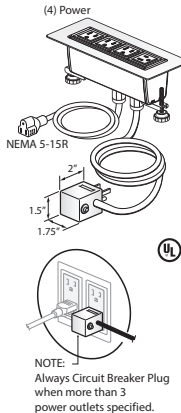
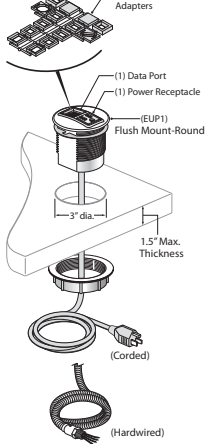
<p>3-Port: (2) Power (1) Smart USB-A+C</p>  <p>UL Power Cord</p> <p>Corded</p>	<p>4-Port: (2) Power (1) Smart USB-A+C (1) Data</p>  <p>UL Power Cord</p> <p>Corded</p>	<p>6-Port: (2) Power (1) Smart USB-A+C (1) Data (1) Cable Bay</p>  <p>UL Power Cord</p> <p>Corded</p>	<p>4-Port: (4) Power</p>  <p>NOTE: Always Circuit Breaker Plug when more than 3 power outlets specified.</p> <p>UL Power Cord</p> <p>Corded</p>	<p>3-Port: (2) Power (1) Smart USB-A+C</p>  <p>UL Hard Wired</p> <p>Hardwire</p>	<p>4-Port: (2) Power (1) Smart USB-A+C (1) Data</p>  <p>UL Hard Wired</p> <p>Hardwire</p>
<p>6-Port: (2) Power (1) Smart USB-A+C (1) Data (1) Cable Bay</p>  <p>UL Hard Wired</p> <p>Hardwire</p>	<p>3-Port: (2) Power (1) Smart USB-A+C</p>  <p>NEMA 5-15R Spiral Cord</p> <p>UL</p> <p>Spiral Cord for Height Adjustable</p>	<p>4-Port: (2) Power (1) Smart USB-A+C (1) Data</p>  <p>NEMA 5-15R Spiral Cord</p> <p>UL</p> <p>Spiral Cord for Height Adjustable</p>	<p>6-Port: (2) Power (1) Smart USB-A+C (1) Data (1) Cable Bay</p>  <p>NEMA 5-15R Spiral Cord</p> <p>UL</p> <p>Spiral Cord for Height Adjustable</p>	<p>4-Port: (4) Power</p>  <p>NOTE: Always Circuit Breaker Plug when more than 3 power outlets specified.</p> <p>UL Spiral Cord</p> <p>Spiral Cord for Height Adjustable</p>	<p>3-Port: (2) Power (1) Smart USB-A+C</p>  <p>NEMA 5-15R Power Cord</p> <p>UL</p> <p>Cord for Height Adjustable</p>
<p>4-Port: (2) Power (1) Smart USB-A+C (1) Data</p>  <p>NEMA 5-15R Power Cord</p> <p>UL</p> <p>Cord for Height Adjustable</p>	<p>6-Port: (2) Power (1) Smart USB-A+C (1) Data (1) Cable Bay</p>  <p>NEMA 5-15R Power Cord</p> <p>UL</p> <p>Cord for Height Adjustable</p>	<p>4-Port: (4) Power</p>  <p>NOTE: Always Circuit Breaker Plug when more than 3 power outlets specified.</p> <p>UL Power Cord</p> <p>Cord for Height Adjustable</p>	<p>Data Port Adapters (1) Data Port (1) Power Receptacle (EUP1) Flush Mount-Round 3" dia. 1.5" Max. Thickness</p>  <p>(Corded) (Hardwired)</p> <p>Round</p>		

Statement of Line

Worksurface Power Modules — Power Tap

Pages 87-90

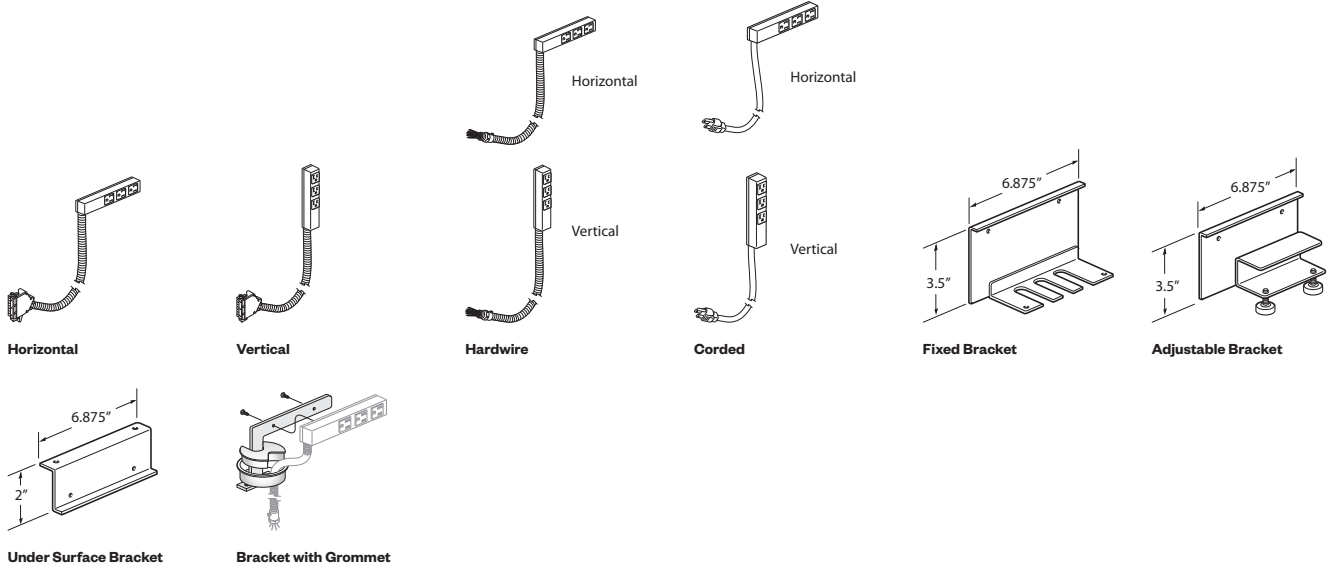

Worksurface Power Modules — Other Power and Data

Pages 91-93

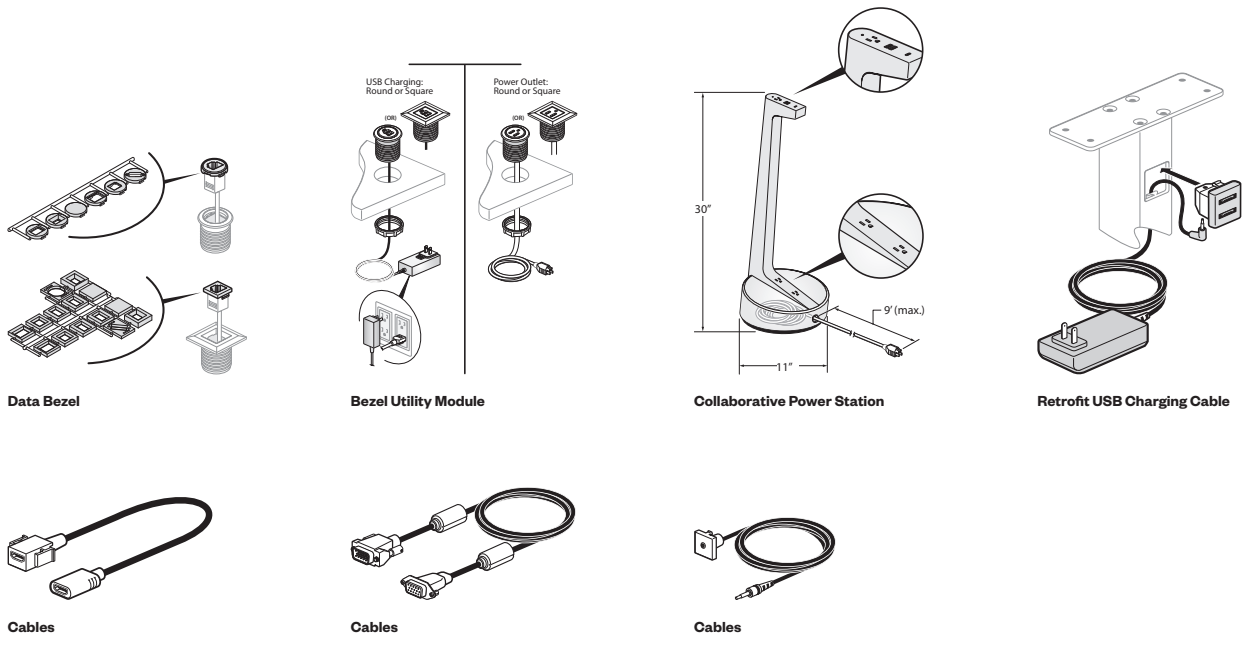

Statement of Line

Cable Management — Horizontal

Pages 94-97

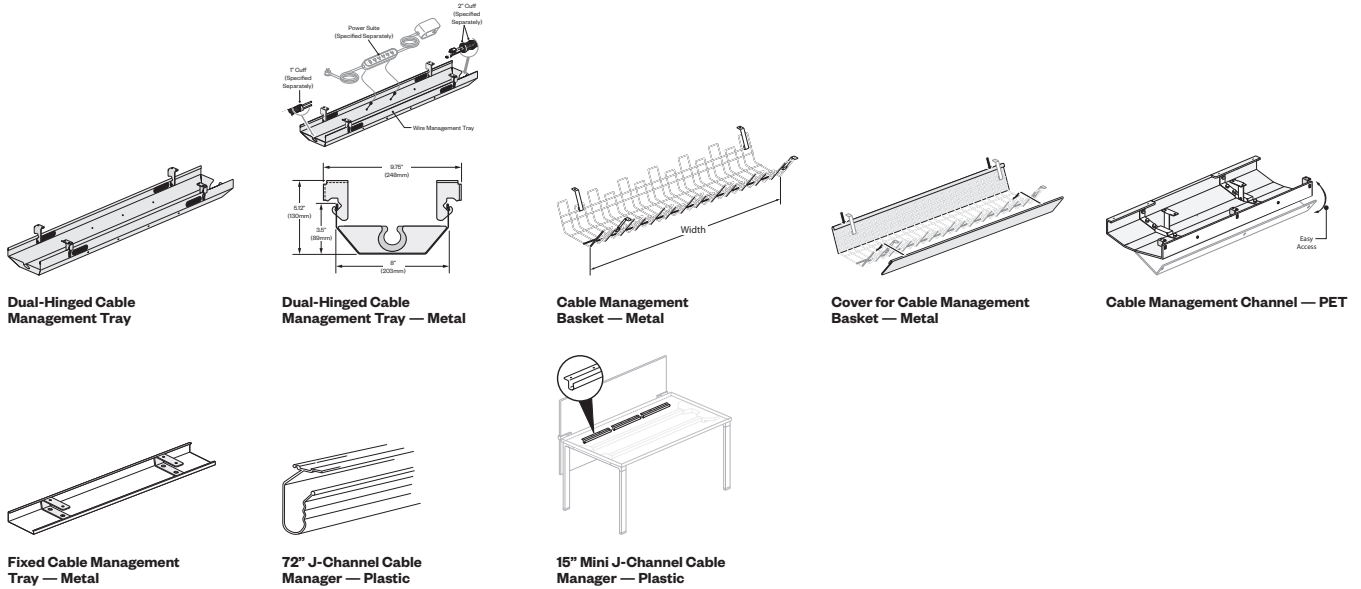

Cable Management — Vertical

Pages 98-99

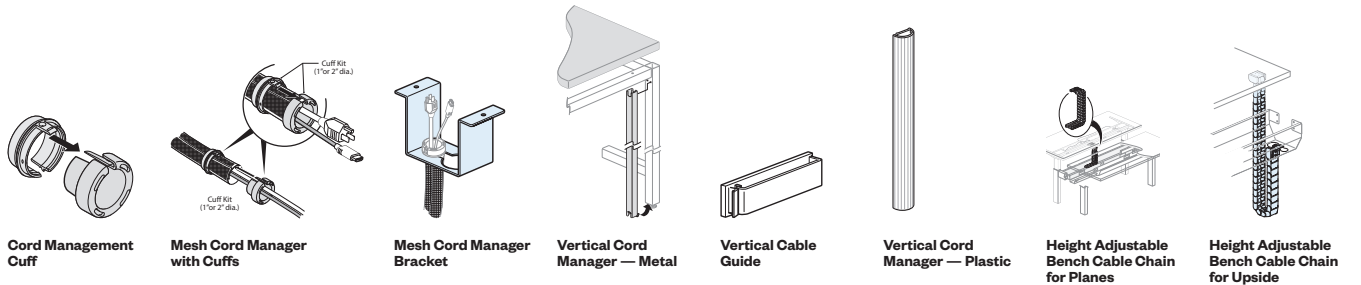

Cable Management Accessories

Pages 100-104

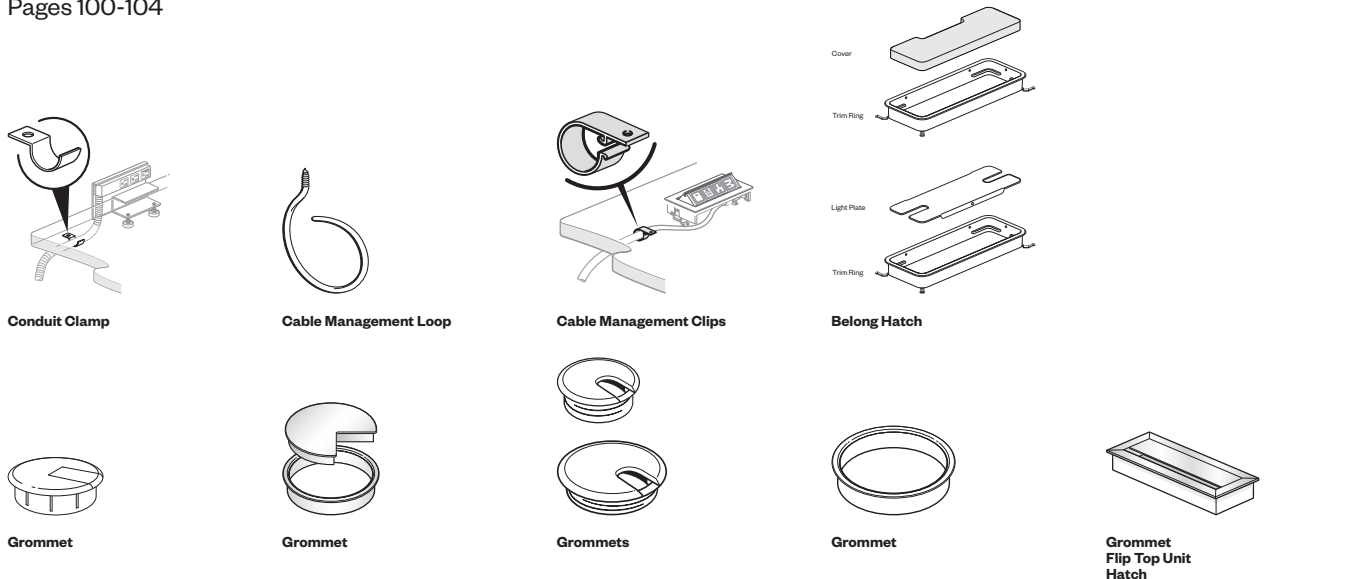

Worksurface Power Modules

Belong Power 65W

Power Cube

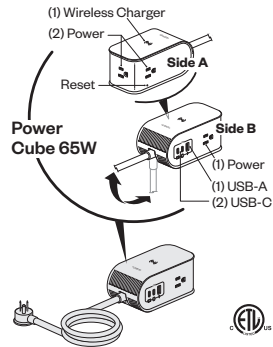

EUC4-BIN1
Class YA – GSA: Open Market

Features

- Includes six power cubes, each with three 120V receptacles (NEMA 5-15R), one USB-A charging port, two USB-C charging ports, one wireless charger, circuit breaker with reset pin hole, and 9’(2743mm) hinged braided power cord with low profile plug (NEMA 5-15P).
- Can be freestanding on worksurface or be used with appropriate mounting bracket.
- 15W (wireless) charging coil on top of cube.
- USB-A and USB-C offer rapid charging capability for a variety of devices.
- USB-A provides single port max charging 60W.
- Each USB-C provides single port max charging 65W.
- Available in charcoal TR-K or snow TR-FM.
- Power Cube has non-slip pad on bottom.
- UL 962A listed Furniture Power Distribution Unit.

Specification Tips

- For additional information on charging refer to the Belong Power 65W charging guide on haworth.com.
- Brackets (EUCB) are optional and can be separately specified.
- Belong Power Units, (Power Suite, Power Cube and Plug Strip), are not designed or UL/CSA listed for daisy-chain applications.
- Application may require approval of local authority having jurisdiction (AHJ); ensure compliance before placing orders and installation.

To Order, Specify:

- 1) Product number.
- 2) Trim color.
TR-K Charcoal
TR-FM Snow

Description	Number	Price
Pack of 6	EUC4-BIN1-31020YN	\$2488.50

Plug Strip

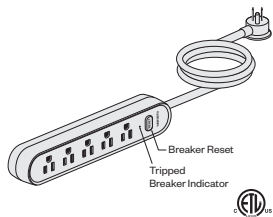

EUR1-BIN1
Class YA – GSA: Open Market

Features

- Includes six plug strips, each with five 120V receptacles (NEMA 5-15R), circuit breaker with a reset indicator light, and 9’(2743mm) braided power cord with low profile plug (NEMA 5-15P).
- Plug Strip can mount in wire management tray or mount directly to the underside of the worksurface without additional bracket.
- Plug Strip has keyhole slots for mounting below worksurface or can be mounted to the back edge of the worksurface using separately specified Plug Strip Brackets (EUPB).
- Available in charcoal TR-K or snow TR-FM.
- UL 962A listed Furniture Power Distribution Unit.

Specification Tips

- Recommended for 23”(584mm)D surfaces which cannot accommodate a wire management tray.
- Belong Power Units, (Power Suite, Power Cube and Plug Strip), are not designed or UL/CSA listed for daisy-chain applications.
- Application may require approval of local authority having jurisdiction (AHJ); ensure compliance before placing orders and installation.

To Order, Specify:

- 1) Product number.
- 2) Trim color.
TR-K Charcoal
TR-FM Snow

Description	Number	Price
Pack of 6	EUR1-BIN1-50000M	\$539.55

Worksurface Power Modules

Belong Power 65W

Power Suite

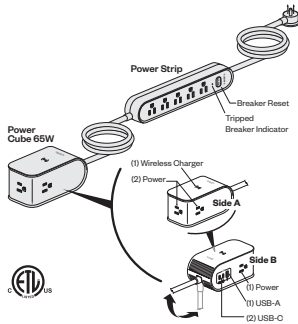

EUB5-BIN1
Class YA - GSA: Open Market

Features

- Includes six power suites, each with three 120V receptacles (NEMA 5-15R), one USB-A charging port, two USB-C charging ports, one wireless charger, one connected plug strip with five 120V receptacles (NEMA 5-15R), circuit breaker, and 9'(2743mm) hinged braided power cord with low profile plug (NEMA 5-15P).
- Cord connecting plug strip to power cube is 4'(1219mm).
- Power Cube can be freestanding on worksurface or be used with appropriate mounting bracket. Plug strip can mount in wire management tray or mount directly to the underside of the worksurface without additional bracket.
- Available in charcoal TR-K or snow TR-FM.
- Power Cube includes:
 - 15W (wireless) charging coil on top of cube.
 - USB-A and USB-C offer rapid charging capability for a variety of devices.
 - USB-A provides single port max charging 60W.
 - Each USB-C provides single port max charging 65W.
 - Non-slip pad on bottom.
- Power Cube included with the Power Suite does not include the reset feature.
- Plug Strip includes:
 - Circuit breaker with a reset indicator light.
 - Keyhole slots for mounting below worksurface.
- UL 962A listed Furniture Power Distribution Unit.

Specification Tips

- Plug Strip designed to be mounted below worksurface for long term connection. Power Cube is mounted above the surface for a convenient power option.
- Recommended for 23"(584mm)D surfaces which cannot accommodate a wire management tray.
- Belong Power Units, (Power Suite, Power Cube and Plug Strip), are not designed or UL/CSA listed for daisy-chain applications.
- Application may require approval of local authority having jurisdiction (AHJ); ensure compliance before placing orders and installation.

To Order, Specify:

- 1) Product number.
- 2) Trim color.
 - TR-K Charcoal
 - TR-FM Snow

Description	Number	Price
Pack of 6	EUB5-BIN1-81020YN	\$3307.50

Worksurface Power Modules

Belong Power 65W

Plug Strip Brackets

Features

- Includes one mounting bracket and thumb screws.
- For use with Belong Plug Strip only.
- Available in standard finishes.

Specification Tips

- Accommodates 1.18" (30mm) - 2" (51mm) thick tops.
- Adjustable bracket mounts Belong Plug Strip to the edge of worksurface with thumb screws for ease of relocation.
- To mount plug strip to the bracket, use hardware provided with the plug strip.
- Not for use with Intuity hatches.
- Application may require approval of local authority having jurisdiction (AHJ); ensure compliance before placing orders and installation.

To Order, Specify:

- 1) Product number.
- 2) Trim color.

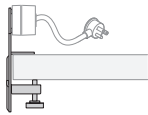
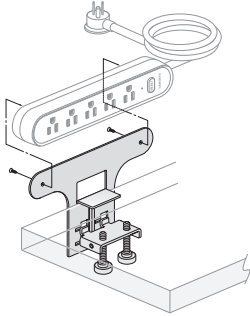

Edgeband Worksurface Mount
EUPB_WJP

EUPB-WJP

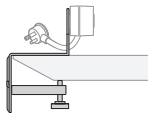
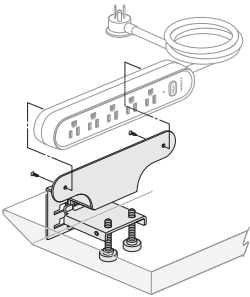

Knife Edge Worksurface Mount
EUPB_WFP

EUPB-WFP

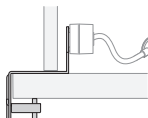
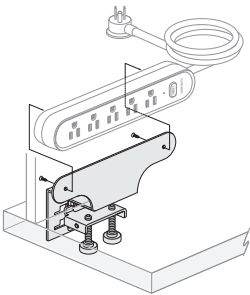

VSU/Tackboard Worksurface Mount
EUPB_TJP

EUPB-TJP

Class YA - GSA: Open Market

Description

Number

Price

Description	Number	Price
Edgeband	EUPB-0000-WJP	\$102.00
Knife Edge	EUPB-0000-WFP	156.00
VSU/Tackboard	EUPB-0000-TJP	144.00

Worksurface Power Modules

Power Cube

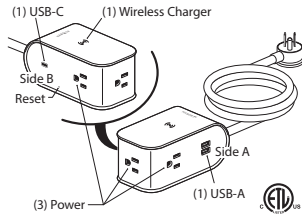

EUC4
Class YA – GSA: Open Market

Features

- Includes one power module with three 120V receptacles (NEMA 5-15R), one dual USB-A charging port, one USB-C charging port, one wireless charger, and 9'(2743mm) hinged braided power cord with low profile plug (NEMA 5-15P).
- Can be freestanding on worksurface or be used with appropriate mounting bracket.
- 10W (wireless) charging coil on top of cube.
- USB-A and USB-C share 15W charging capability.
- USB-A provides two ports.
- USB-C provides one port for fast charge for a mobile phone.
- Power Cube has non-slip pad on bottom.

Specification Tips

- Available in charcoal TR-K or snow TR-FM.
- Brackets (EUCB) are optional and can be separately specified.
- Application may require approval of local authority having jurisdiction (AHJ); ensure compliance before placing orders and installation.

To Order, Specify:

- 1) Product number.
- 2) Trim color.
TR-K Charcoal
TR-FM Snow

Number	Price
EUC4-BINI-31100YN	\$383.98

Plug Strip

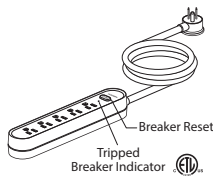

EUR1
Class YA – GSA: Open Market

Features

- Includes one plug strip with five 120V receptacles (NEMA 5-15R), circuit breaker, and 9'(2743mm) braided power cord with low profile plug (NEMA 5-15P).
- Plug Strip can mount in wire management tray or mount directly to the underside of the worksurface without additional bracket.
- Plug Strip has keyhole slots for mounting below worksurface.
- UL 962A listed Furniture Power Distribution Unit.

Specification Tips

- Available in charcoal TR-K or snow TR-FM.
- Recommended for 23"(584mm)D surfaces which cannot accommodate a wire management tray.
- Application may require approval of local authority having jurisdiction (AHJ); ensure compliance before placing orders and installation.

To Order, Specify:

- 1) Product number.
- 2) Trim color.
TR-K Charcoal
TR-FM Snow

Number	Price
EUR1-BINI-50000	\$94.42

Power Suite

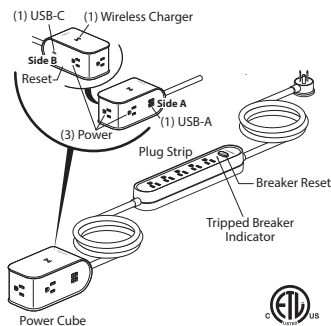

EUB5
Class YA – GSA: Open Market

Features

- Includes one power module with three 120V receptacles (NEMA 5-15R), one dual USB-A charging port, one USB-C charging port, one wireless charger, one connected plug strip with five 120V receptacles (NEMA 5-15R), circuit breaker, and 9'(2743mm) hinged braided power cord with low profile plug (NEMA 5-15P).
- Cord connecting plug strip to power cube is 4'(1219mm).
- Power Cube can be freestanding on worksurface or be used with appropriate mounting bracket. Plug strip can mount in wire management tray or mount directly to the underside of the worksurface without additional bracket.
- 10W (wireless) charging coil on top of cube.
- USB-A and USB-C share 15W charging capability.
- USB-A provides two ports.
- USB-C provides one port for fast charge for a mobile phone.
- Power Cube has non-slip pad on bottom.
- Plug Strip has keyhole slots for mounting below worksurface.
- Circuit breaker has a reset indicator light.

Specification Tips

- Available in charcoal TR-K or snow TR-FM.
- Plug Strip designed to be mounted below worksurface for long term connection. Power Cube is mounted above the surface for a convenient power option.
- Recommended for 23"(584mm)D surfaces which cannot accommodate a wire management tray.
- Application may require approval of local authority having jurisdiction (AHJ); ensure compliance before placing orders and installation.

To Order, Specify:

- 1) Product number.
- 2) Trim color.
TR-K Charcoal
TR-FM Snow

Number	Price
EUB5-BINI-81100YN	\$446.93

Worksurface Power Modules

Power Cube and Power Suite

Brackets

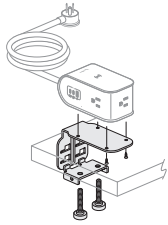

Standard Edge Worksurface Mount



EUCB-WJP

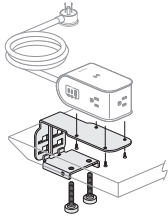

Knife Edge Worksurface Mount

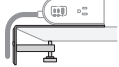

EUCB-WFP

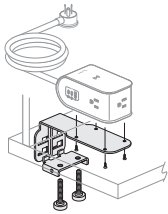

Knife Edge Worksurface Mount

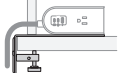

EUCB-TJP

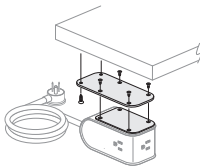

Under Worksurface Mount

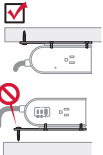

Above Worksurface Application
(Bracket NOT Fastened or Needed)

EUUB-UP

Class YA – GSA: Open Market

Features

- Includes mounting bracket and mounting hardware.
- For use with Belong Power Solutions cube and suite. Not for use with the Power Strip.

Specification Tips

- Accommodates 1.18”(30mm) thick tops with clear space below.
- Available in standard finishes.
- Application may require approval of local authority having jurisdiction (AHJ); ensure compliance before placing orders and installation.

To Order, Specify:

- 1) Product number.
- 2) Trim color.
 - TR-K Charcoal
 - TR-FM Snow

Description	Number	Price
Edgeband	EUCB-0000-WJP	\$65.81
Knife Edge	EUCB-0000-WFP	151.36
VSU/Tackboard	EUCB-0000-TJP	65.81
Undersurface	EUUB-0503-UP	34.33

Worksurface Power Modules

Wireless Charging Module

EUWC-PFOB-12002

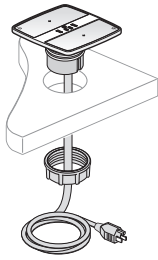

EUWC-PFOB
EUWC-PFOW
EUWC-HLOB
EUWC-HLOW



Class YA - GSA: Open Market

Features

- Includes power module with simplex outlet (NEMA-15R), two USB charging simplex and two charging Qi pads with soft touch plastic inserts and mounting hardware.
- 5 Watt Qi charging coil.
- Coded power module with 15 amp - 6'(1829mm) or 12'(3658mm) long cord with plug (NEMA 5-15P).
- Hardwired power module with 12'(3658mm) long flexible metal conduit feed, 0.5"(13mm) conduit fitting and wires for hardwire connection.
- USB Charging Port consists of one 5V USB 2.0 style A outlet. 2 Amp (shared) charging capacity.
- Attaches to 1"(25mm) to 1.5"(38mm) thick surface with use of included mounting brackets.
- Color option of black or white plastic face.

Specification Tips

- **Not for use with 2"(51mm) thick tops.**
- Configuration and quantity of power and USB ports cannot be modified in the field.
- For use with 120 volt 60 hertz power source only.
- Requires field installation.
- Requires field cut 3"(76mm) diameter access hole for power cord/conduit routing.
- Application may require approval of local authority having jurisdiction (AHJ); ensure compliance before placing orders and installation.
- Separately specified:
 - Horizontal and Vertical Wire Management

To Order, Specify:

- 1) Product number.
(No finish specification required.)

Width	Depth	Cord Length	Housing Color	Configuration	Number	Price
Corded						
7.38"(187mm)	7"(178mm)	6'(1829mm)	Black	1 Power Receptacle, 2 USB Charging, 2 Charging Pad	EUWC-PFOB-12002	\$ 1187.82
			White	1 Power Receptacle, 2 USB Charging, 2 Charging Pad	EUWC-PFOW-12002	1187.82
7.38"(187mm)	7"(178mm)	12'(3658mm)	Black	1 Power Receptacle, 2 USB Charging, 2 Charging Pad	EUWC-PLOB-12002	1281.38
			White	1 Power Receptacle, 2 USB Charging, 2 Charging Pad	EUWC-PLOW-12002	1281.38
Hardwire						
7.38"(187mm)	7"(178mm)	12'(3658mm)	Black	1 Power Receptacle, 2 USB Charging, 2 Charging Pad	EUWC-HLOB-12002	\$1398.66
			White	1 Power Receptacle, 2 USB Charging, 2 Charging Pad	EUWC-HLOW-12002	1398.66

Worksurface Power Modules — Enhanced Power Seamless

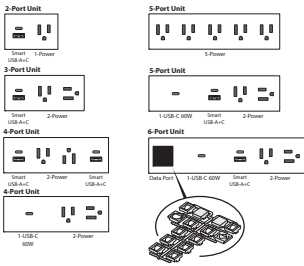
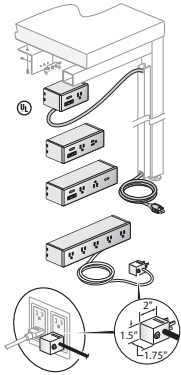

EUS1-PF0B

EUS1-HLOB
EUS1-HLOW

Class YA – GSA: Open Market

Features

- Includes power module with 2, 3, 4, 5 or 6 ports configured with simplex outlets (NEMA-5-15R), USB charging port (Smart USB-A+C) or data ports and mounting hardware.
- Power Modules specified with a data port includes a variety of data port adapters and blank covers, which accommodate most varieties of field supplied data/AV Jacks.
- The Smart USB-A+C allows for the 20W to be transferred between the 2 ports. If the USB-A is being used, the full wattage is sent to the USB-A, and the same for the USB-C. If both are being used, the wattage is distributed to each port and the port drawing the most power will receive more watts than the one that is not.
- Corded power module with 15 amp - 6'(1829mm) or 12'(3658mm) long cord with plug (NEMA 5-15P).
- Hardwire power module with 12'(3658mm) flexible galvanized metal conduit with fitting for 0.5"(13mm) knockout and wires for hardwire connection.
- USB-C 60W charging ports not available for hardwire.
- Smart USB-A+C can provide fast charge for a mobile phone and tablets. Occupies one charging port.
- USB-C 60W can charge a computer. Occupies two charging ports.
- Attaches to surface with separately specified mounting brackets.
- Enhanced Power Module Bracket EUDB-0000-B_ for perimeter edge power.
- Color option of black or white plastic front.

Specification Tips

- Configuration and quantity of power and data ports cannot be modified in the field.
- For use with 120 volt 60 hertz power source only.
- Requires field installation.
- Specify AV cables separately.
- Application may require approval of local authority having jurisdiction (AHJ); ensure compliance before placing orders and installation.
- Separately specified:
 - Mounting Bracket
 - Horizontal and Vertical Wire Management

To Order, Specify:

- 1) Product number.
(No finish specification required.)

Worksurface Power Modules — Enhanced Power Seamless

Depth	Width	Cord Length	Trim Color	Color	Port	Configuration	Number	Price
Corded								
1.875"(48mm)	4"(102mm)	6'(1829mm)	Black	Black	2	1 Power Receptacles, 1 Data Port	EUS1-PFOB-1010	\$ 539.65
						1 Power Receptacles, 1 Smart USB-A+C Charging	EUS1-PFOB-1100	645.47
						2 Power Receptacles	EUS1-PFOB-2000	539.65
	5.5"(140mm)	3	1 Power Receptacles, 1 USB-C 60W Charging	EUS1-PFOB-100001	\$ 923.98			
			2 Power Receptacles, 1 Data Port	EUS1-PFOB-2010	631.36			
			2 Power Receptacles, 1 Smart USB-A+C Charging	EUS1-PFOB-2100	737.18			
	7"(178mm)	4	3 Power Receptacles	EUS1-PFOB-3000	631.36			
			2 Power Receptacles, 2 Smart USB-A+C Charging	EUS1-PFOB-210010	\$ 843.00			
			2 Power Receptacles, 1 USB-C 60W Charging	EUS1-PFOB-200001	923.98			
	9.5"(241mm)	5	2 Power Receptacles, 1 Data Port, 1 Smart USB-A+C Charging	EUS1-PFOB-201010	737.18			
			2 Power Receptacles, 1 Smart USB-A+C Charging, 1 USB-C 60W Charging	EUS1-PFOB-210001	\$ 1121.50			
			3 Power Receptacles, 1 Smart USB-A+C Charging, 1 Data Port	EUS1-PFOB-3110	828.88			
3 Power Receptacles, 2 Smart USB-A+C Charging			EUS1-PFOB-3200	934.70				
4 Power Receptacles, 1 Data Port			EUS1-PFOB-4010	723.06				
11"(279mm)	6	5 Power Receptacles	EUS1-PFOB-5000	723.06				
		2 Power Receptacles, 1 Smart USB-A+C Charging, 1 Data Port, 1 USB-C 60W Charging	EUS1-PFOB-211001	\$ 1213.20				
		1 Power Receptacles, 1 Data Port	EUS1-PFOW-1010	\$ 356.24				
1.875"(48mm)	4"(102mm)	6'(1829mm)	White	White	2	1 Power Receptacles, 1 Smart USB-A+C Charging	EUS1-PFOW-1100	462.06
						2 Power Receptacles	EUS1-PFOW-2000	356.24
						1 Power Receptacles, 1 USB-C 60W Charging	EUS1-PFOW-100001	\$ 740.57
	5.5"(140mm)	3	2 Power Receptacles, 1 Data Port	EUS1-PFOW-2010	447.95			
			2 Power Receptacles, 1 Smart USB-A+C Charging	EUS1-PFOW-2100	553.77			
			3 Power Receptacles	EUS1-PFOW-3000	447.95			
	7"(178mm)	4	2 Power Receptacles, 2 Smart USB-A+C Charging	EUS1-PFOW-210010	\$ 659.59			
			2 Power Receptacles, 1 USB-C 60W Charging	EUS1-PFOW-200001	740.57			
			2 Power Receptacles, 1 Data Port, 1 Smart USB-A+C Charging	EUS1-PFOW-201010	553.77			
	9.5"(241mm)	5	2 Power Receptacles, 1 Smart USB-A+C Charging, 1 USB-C 60W Charging	EUS1-PFOW-210001	\$ 938.09			
			3 Power Receptacles, 1 Smart USB-A+C Charging, 1 Data Port	EUS1-PFOW-3110	645.47			
			3 Power Receptacles, 2 Smart USB-A+C Charging	EUS1-PFOW-3200	751.29			
4 Power Receptacles, 1 Data Port			EUS1-PFOW-4010	539.65				
5 Power Receptacles			EUS1-PFOW-5000	539.65				
11"(279mm)	6	2 Power Receptacles, 1 Smart USB-A+C Charging, 1 Data Port, 1 USB-C 60W Charging	EUS1-PFOW-211001	\$1029.79				
		1 Power Receptacles, 1 Data Port	EUS1-PL0B-1010	\$ 625.86				
		1 Power Receptacles, 1 Smart USB-A+C Charging	EUS1-PL0B-1100	731.68				
1.875"(48mm)	4"(102mm)	12'(3658mm)	Black	Black	2	2 Power Receptacles	EUS1-PL0B-2000	625.86
						1 Power Receptacles, 1 USB-C 60W Charging	EUS1-PL0B-100001	\$ 1010.19
						2 Power Receptacles, 1 Data Port	EUS1-PL0B-2010	717.57
	5.5"(140mm)	3	2 Power Receptacles, 1 Smart USB-A+C Charging	EUS1-PL0B-2100	823.39			
			3 Power Receptacles	EUS1-PL0B-3000	717.57			
			2 Power Receptacles, 2 Smart USB-A+C Charging	EUS1-PL0B-210010	\$ 929.21			
	7"(178mm)	4	2 Power Receptacles, 1 USB-C 60W Charging	EUS1-PL0B-200001	1010.19			
			2 Power Receptacles, 1 Data Port, 1 Smart USB-A+C Charging	EUS1-PL0B-201010	823.39			
			2 Power Receptacles, 1 Smart USB-A+C Charging, 1 USB-C 60W Charging	EUS1-PL0B-210001	\$ 1207.71			
	9.5"(241mm)	5	3 Power Receptacles, 1 Smart USB-A+C Charging, 1 Data Port	EUS1-PL0B-3110	915.09			
			3 Power Receptacles, 2 Smart USB-A+C Charging	EUS1-PL0B-3200	1020.91			
			4 Power Receptacles, 1 Data Port	EUS1-PL0B-4010	809.27			
5 Power Receptacles			EUS1-PL0B-5000	809.27				
2 Power Receptacles, 1 Smart USB-A+C Charging, 1 Data Port, 1 USB-C 60W Charging			EUS1-PL0B-211001	\$1299.41				

Worksurface Power Modules — Enhanced Power Seamless

Depth	Width	Cord Length	Trim Color	Color	Port	Configuration	Number	Price					
Corded													
1.875"(48mm)	4"(102mm)	12'(3658mm)	White	White	2	1 Power Receptacles, 1 Data Port	EUS1-PLOW-1010	\$ 442.45					
						1 Power Receptacles, 1 Smart USB-A+C Charging	EUS1-PLOW-1100	548.27					
						2 Power Receptacles	EUS1-PLOW-2000	442.45					
5.5"(140mm)					3	1 Power Receptacles, 1 USB-C 60W Charging	EUS1-PLOW-100001	\$ 826.78					
						2 Power Receptacles, 1 Data Port	EUS1-PLOW-2010	534.16					
						2 Power Receptacles, 1 Smart USB-A+C Charging	EUS1-PLOW-2100	639.98					
7"(178mm)					4	3 Power Receptacles	EUS1-PLOW-3000	534.16					
						2 Power Receptacles, 2 Smart USB-A+C Charging	EUS1-PLOW-210010	\$ 745.80					
						2 Power Receptacles, 1 USB-C 60W Charging	EUS1-PLOW-200001	826.78					
9.5"(241mm)					5	2 Power Receptacles, 1 Data Port, 1 Smart USB-A+C Charging	EUS1-PLOW-201010	639.98					
						2 Power Receptacles, 1 Smart USB-A+C Charging, 1 USB-C 60W Charging	EUS1-PLOW-210001	\$1024.30					
						3 Power Receptacles, 1 Smart USB-A+C Charging, 1 Data Port	EUS1-PLOW-3110	731.68					
11"(279mm)					6	3 Power Receptacles, 2 USB-A+C Charging	EUS1-PLOW-3200	837.50					
						4 Power Receptacles, 1 Data Port	EUS1-PLOW-4010	625.86					
						5 Power Receptacles	EUS1-PLOW-5000	625.86					
1.875"(48mm)	4"(102mm)	12'(3658mm)	Black	Black	2	2 Power Receptacles, 1 Smart USB-A+C Charging, 1 Data Port, 1 USB-C 60W Charging	EUS1-PLOW-211001	\$ 1116.00					
						Hardwire							
						1 Power Receptacles, 1 Data Port	EUS1-HLOB-1010	\$ 733.93					
5.5"(140mm)					3	1 Power Receptacles, 1 Smart USB-A+C Charging	EUS1-HLOB-1100	839.75					
						2 Power Receptacles	EUS1-HLOB-2000	733.93					
						2 Power Receptacles, 1 Data Port	EUS1-HLOB-2010	\$ 825.64					
7"(178mm)					4	2 Power Receptacles, 1 Smart USB-A+C Charging	EUS1-HLOB-2100	931.46					
						2 Power Receptacles, 1 Smart USB-A+C Charging	EUS1-HLOB-2110	\$ 931.46					
						3 Power Receptacles	EUS1-HLOB-3000	825.64					
9.5"(241mm)					5	2 Power Receptacles, 1 Smart USB-A+C Charging, 1 Data Port	EUS1-HLOB-2110	\$ 931.46					
						2 Power Receptacles, 2 Smart USB-A+C Charging	EUS1-HLOB-2200	1037.28					
						3 Power Receptacles, 1 Smart USB-A+C Charging, 1 Data Port	EUS1-HLOB-3110	\$1023.16					
1.875"(48mm)	4"(102mm)	12'(3658mm)	White	White	2	3 Power Receptacles, 2 Smart USB-A+C Charging	EUS1-HLOB-3200	1128.98					
						4 Power Receptacles, 1 Data Port	EUS1-HLOB-4010	917.34					
						5 Power Receptacles	EUS1-HLOB-5000	917.34					
5.5"(140mm)					3	1 Power Receptacles, 1 Data Port	EUS1-HLOW-1010	\$ 550.52					
						1 Power Receptacles, 1 Smart USB-A+C Charging	EUS1-HLOW-1100	656.34					
						2 Power Receptacles	EUS1-HLOW-2000	550.52					
7"(178mm)					4	2 Power Receptacles, 1 Data Port	EUS1-HLOW-2010	\$ 642.23					
						2 Power Receptacles, 1 Smart USB-A+C Charging	EUS1-HLOW-2100	748.05					
						3 Power Receptacles	EUS1-HLOW-3000	642.23					
9.5"(241mm)					5	2 Power Receptacles, 1 Smart USB-A+C Charging, 1 Data Port	EUS1-HLOW-2110	\$ 748.05					
						2 Power Receptacles, 2 Smart USB-A+C Charging	EUS1-HLOW-2200	853.87					
						3 Power Receptacles, 1 Smart USB-A+C Charging, 1 Data Port	EUS1-HLOW-3110	\$ 839.75					
1.875"(48mm)	4"(102mm)	12'(3658mm)	White	White	2	3 Power Receptacles, 2 Smart USB-A+C Charging	EUS1-HLOW-3200	945.57					
						4 Power Receptacles, 1 Data Port	EUS1-HLOW-4010	733.93					
						5 Power Receptacles	EUS1-HLOW-5000	733.93					

Worksurface Power Modules — Enhanced Power

Corded

3-Port:

- (2) Power
- (1) Smart USB-A+C



EUDI-PF0B-2100

4-Port:

- (2) Power
- (1) Smart USB-A+C
- (1) Data



EUDI-PF0B-2110

6-Port:

- (2) Power
- (1) Smart USB-A+C
- (1) Data
- (1) Cable Bay

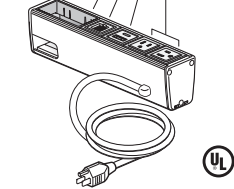

EUDI-PF0B-2112

4-Port:

- (4) Power

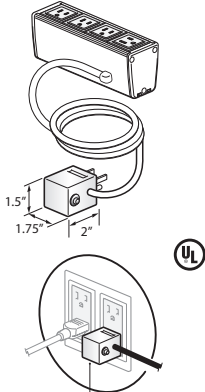

NOTE:
Always Circuit Breaker Plug
when more than 3
power outlets specified.

EUDI-PF0B-4000

Class YA

Features

- Includes power module with 3, 4 or 6 ports that can be configured with simplex outlets (NEMA-5-15R), USB charging port (Smart USB-A+C), data ports or cable bay(s) that can accept up to two pull out data/AV cables and mounting hardware.
- Data port accommodate most varieties of field supplied data/ AV jacks.
- Attaches to surface with use of separately specified mounting brackets.
- Corded power module available with 15 amp - 6'(1829mm) or 12'(3658mm) long cord with plug (NEMA 5-15P).
- The Smart USB-A+C allows for the 20W to be transferred between the 2 ports. If the USB-A is being used, the full wattage is sent to the USB-A, and the same for the USB-C. If both are being used, the wattage is distributed to each port and the port drawing the most power will receive more watts than the one that is not.
- Color option of black anodized housing with black receptacles or clear anodized housing with white receptacles.

Specification Tips

- **Configuration and quantity of power and data ports cannot be modified in the field.**
- **For use with 120 volt 60 hertz power source only.**
- Separately specify attachment hardware for desired application.
- Requires field installation.
- Specify AV cables separately.
- Cable Bay requires cables less than 0.3"(8mm) diameter.
- Application may require approval of local authority having jurisdiction (AHJ); ensure compliance before placing orders and installation.

To Order, Specify:

- 1) Product number.
(No finish specification required.)

Worksurface Power Modules — Enhanced Power Corded

Top Depth	Top Width	Cord Length	Housing Color	Port Color	Port	Configuration	Number	Price						
3"(76mm)	5"(127mm)	6'(1829mm)	Black Anodized	Black	3	1 Power Receptacle, 1 Cable Bay	EUDI-PFOB-1002	\$ 620.59						
						1 Power Receptacle, 2 Data Ports	EUDI-PFOB-1020	620.59						
						1 Power Receptacle, 1 Data Port, 1 Smart USB-A+C Charging	EUDI-PFOB-1110	726.41						
						1 Power Receptacle, 2 Smart USB-A+C Charging	EUDI-PFOB-1200	832.23						
						2 Power Receptacles, 1 Data Port	EUDI-PFOB-2010	620.59						
						2 Power Receptacles, 1 Smart USB-A+C Charging	EUDI-PFOB-2100	726.41						
						3 Power Receptacles	EUDI-PFOB-3000	620.59						
3"(76mm)	6.5"(165mm)				4	1 Power Receptacle, 1 Data Port, 1 Cable Bay	EUDI-PFOB-1012	\$ 620.59						
						1 Power Receptacle, 3 Data Ports	EUDI-PFOB-1030	620.59						
						1 Power Receptacle, 1 Smart USB-A+C Charging, 1 Cable Bay	EUDI-PFOB-1102	726.41						
						1 Power Receptacle, 3 Smart USB-A+C Charging	EUDI-PFOB-1300	938.05						
						2 Power Receptacles, 1 Cable Bay	EUDI-PFOB-2002	620.59						
						2 Power Receptacles, 2 Data Ports	EUDI-PFOB-2020	620.59						
						2 Power Receptacles, 1 Smart USB-A+C Charging, 1 Data Port	EUDI-PFOB-2110	726.41						
						2 Power Receptacles, 2 Smart USB-A+C Charging	EUDI-PFOB-2200	832.23						
						3 Power Receptacles, 1 Data Port	EUDI-PFOB-3010	620.59						
						3 Power Receptacles, 1 Smart USB-A+C Charging	EUDI-PFOB-3100	726.41						
						4 Power Receptacles	EUDI-PFOB-4000	620.59						
						3"(76mm)	9.5"(241mm)				6	1 Power Receptacle, 1 Smart USB-A+C Charging, 2 Cable Bays	EUDI-PFOB-1104	\$ 818.11
												1 Power Receptacle, 1 Smart USB-A+C Charging, 2 Data Ports, 1 Cable Bay	EUDI-PFOB-1122	818.11
1 Power Receptacle, 1 Smart USB-A+C Charging, 4 Data Ports	EUDI-PFOB-1140	818.11												
1 Power Receptacle, 2 Smart USB-A+C Charging, 1 Data Port, 1 Cable Bay	EUDI-PFOB-1212	923.93												
1 Power Receptacle, 2 Smart USB-A+C Charging, 3 Data Ports	EUDI-PFOB-1230	923.93												
1 Power Receptacle, 3 Smart USB-A+C Charging, 1 Cable Bay	EUDI-PFOB-1302	1029.75												
1 Power Receptacle, 3 Smart USB-A+C Charging, 2 Data Ports	EUDI-PFOB-1320	1029.75												
1 Power Receptacle, 4 Smart USB-A+C Charging, 1 Data Port	EUDI-PFOB-1410	1135.57												
2 Power Receptacles, 2 Cable Bays	EUDI-PFOB-2004	712.29												
2 Power Receptacles, 2 Data Ports, 1 Cable Bay	EUDI-PFOB-2022	712.29												
2 Power Receptacles, 4 Data Ports	EUDI-PFOB-2040	712.29												
2 Power Receptacles, 1 Smart USB-A+C Charging, 1 Data Port, 1 Cable Bay	EUDI-PFOB-2112	818.11												
2 Power Receptacles, 1 Smart USB-A+C Charging, 3 Data Ports	EUDI-PFOB-2130	818.11												
2 Power Receptacles, 2 Smart USB-A+C Charging, 1 Cable Bay	EUDI-PFOB-2202	923.93												
2 Power Receptacles, 2 Smart USB-A+C Charging, 2 Data Ports	EUDI-PFOB-2220	923.93												
2 Power Receptacles, 3 Smart USB-A+C Charging, 1 Data Port	EUDI-PFOB-2310	1029.75												
2 Power Receptacles, 4 Smart USB-A+C Charging	EUDI-PFOB-2400	1135.57												
3 Power Receptacles, 3 Data Ports	EUDI-PFOB-3030	712.29												
3 Power Receptacles, 1 Smart USB-A+C Charging, 1 Cable Bay	EUDI-PFOB-3102	818.11												
3 Power Receptacles, 1 Smart USB-A+C Charging, 2 Data Ports	EUDI-PFOB-3120	818.11												
3 Power Receptacles, 2 Smart USB-A+C Charging, 1 Data Port	EUDI-PFOB-3210	923.93												
3 Power Receptacles, 3 Smart USB-A+C Charging	EUDI-PFOB-3300	1029.75												
4 Power Receptacles, 1 Cable Bay	EUDI-PFOB-4002	712.29												
4 Power Receptacles, 2 Data Ports	EUDI-PFOB-4020	712.29												
4 Power Receptacles, 1 Smart USB-A+C Charging, 1 Data Port	EUDI-PFOB-4110	818.11												
4 Power Receptacles, 2 Smart USB-A+C Charging	EUDI-PFOB-4200	923.93												
5 Power Receptacles, 1 Data Port	EUDI-PFOB-5010	712.29												
5 Power Receptacles, 1 Smart USB-A+C Charging	EUDI-PFOB-5100	818.11												
6 Power Receptacles	EUDI-PFOB-6000	712.29												

Worksurface Power Modules — Enhanced Power Corded

Top Depth	Top Width	Cord Length	Housing Color	Port Color	Port	Configuration	Number	Price
3"(76mm)	9.5"(241mm)	6'(1829mm)	Clear Anodized	White	3	1 Power Receptacle, 1 Cable Bay	EUDI-PFOW-1002	\$ 437.18
						1 Power Receptacle, 2 Data Ports	EUDI-PFOW-1020	437.18
						1 Power Receptacle, 1 Data Port, 1 Smart USB-A+C Charging	EUDI-PFOW-1100	543.00
					4	1 Power Receptacle, 2 Smart USB-A+C Charging	EUDI-PFOW-1200	648.82
						2 Power Receptacles, 1 Data Port	EUDI-PFOW-2010	437.18
						2 Power Receptacles, 1 Smart USB-A+C Charging	EUDI-PFOW-2100	543.00
						3 Power Receptacles	EUDI-PFOW-3000	437.18
						1 Power Receptacle, 1 Data Port, 1 Cable Bay	EUDI-PFOW-1012	\$ 437.18
						1 Power Receptacle, 3 Data Ports	EUDI-PFOW-1030	437.18
						1 Power Receptacle, 1 Smart USB-A+C Charging, 1 Cable Bay	EUDI-PFOW-1102	543.00
						1 Power Receptacle, 3 Smart USB-A+C Charging	EUDI-PFOW-1300	754.64
						2 Power Receptacles, 1 Cable Bay	EUDI-PFOW-2002	437.18
						2 Power Receptacles, 2 Data Ports	EUDI-PFOW-2020	437.18
						2 Power Receptacles, 1 Smart USB-A+C Charging, 1 Data Port	EUDI-PFOW-2110	543.00
						2 Power Receptacles, 2 Smart USB-A+C Charging	EUDI-PFOW-2200	648.82
					6	3 Power Receptacles, 1 Data Port	EUDI-PFOW-3010	437.18
						3 Power Receptacles, 1 Smart USB-A+C Charging	EUDI-PFOW-3100	543.00
						4 Power Receptacles	EUDI-PFOW-4000	437.18
						1 Power Receptacle, 1 Smart USB-A+C Charging, 2 Cable Bays	EUDI-PFOW-1104	\$634.70
						1 Power Receptacle, 1 Smart USB-A+C Charging, 2 Data Ports, 1 Cable Bay	EUDI-PFOW-1122	634.70
						1 Power Receptacle, 1 Smart USB-A+C Charging, 4 Data Ports	EUDI-PFOW-1140	634.70
						1 Power Receptacle, 2 Smart USB-A+C Charging, 1 Data Port, 1 Cable Bay	EUDI-PFOW-1212	740.52
						1 Power Receptacle, 2 Smart USB-A+C Charging, 3 Data Ports	EUDI-PFOW-1230	740.52
						1 Power Receptacle, 3 Smart USB-A+C Charging, 1 Cable Bay	EUDI-PFOW-1302	846.34
						1 Power Receptacle, 3 Smart USB-A+C Charging, 2 Data Ports	EUDI-PFOW-1320	846.34
						1 Power Receptacle, 4 Smart USB-A+C Charging, 1 Data Port	EUDI-PFOW-1410	952.16
						2 Power Receptacles, 2 Cable Bays	EUDI-PFOW-2004	528.88
						2 Power Receptacles, 2 Data Ports, 1 Cable Bay	EUDI-PFOW-2022	528.88
						2 Power Receptacles, 4 Data Ports	EUDI-PFOW-2040	528.88
						2 Power Receptacles, 1 Smart USB-A+C Charging, 1 Data Port, 1 Cable Bay	EUDI-PFOW-2112	634.70
2 Power Receptacles, 1 Smart USB-A+C Charging, 3 Data Ports	EUDI-PFOW-2130	634.70						
2 Power Receptacles, 2 Smart USB-A+C Charging, 1 Cable Bay	EUDI-PFOW-2202	740.52						
2 Power Receptacles, 2 Smart USB-A+C Charging, 2 Data Ports	EUDI-PFOW-2220	740.52						
2 Power Receptacles, 3 Smart USB-A+C Charging, 1 Data Port	EUDI-PFOW-2310	846.34						
2 Power Receptacles, 4 Smart USB-A+C Charging	EUDI-PFOW-2400	952.16						
3 Power Receptacles, 3 Data Ports	EUDI-PFOW-3030	528.88						
3 Power Receptacles, 1 Smart USB-A+C Charging, 1 Cable Bay	EUDI-PFOW-3102	634.70						
3 Power Receptacles, 1 Smart USB-A+C Charging, 2 Data Ports	EUDI-PFOW-3120	634.70						
3 Power Receptacles, 2 Smart USB-A+C Charging, 1 Data Port	EUDI-PFOW-3210	740.52						
3 Power Receptacles, 3 Smart USB-A+C Charging	EUDI-PFOW-3300	846.34						
4 Power Receptacles, 1 Cable Bay	EUDI-PFOW-4002	528.88						
4 Power Receptacles, 2 Data Ports	EUDI-PFOW-4020	528.88						
4 Power Receptacles, 1 Smart USB-A+C Charging, 1 Data Port	EUDI-PFOW-4110	634.70						
4 Power Receptacles, 2 Smart USB-A+C Charging	EUDI-PFOW-4200	740.52						
5 Power Receptacles, 1 Data Port	EUDI-PFOW-5010	528.88						
5 Power Receptacles, 1 Smart USB-A+C Charging	EUDI-PFOW-5100	634.70						
6 Power Receptacles	EUDI-PFOW-6000	528.88						

Worksurface Power Modules — Enhanced Power Corded

Top Depth	Top Width	Cord Length	Housing Color	Port Color	Port	Configuration	Number	Price	
3"(76mm)	9.5"(241mm)	12'(3658mm)	Black Anodized	Black	3	1 Power Receptacle, 1 Cable Bay	EUDI-PLOB-1002	\$ 706.80	
						1 Power Receptacle, 2 Data Ports	EUDI-PLOB-1020	706.80	
						1 Power Receptacle, 1 Data Port, 1 Smart USB-A+C Charging	EUDI-PLOB-1110	812.62	
						1 Power Receptacle, 2 Smart USB-A+C Charging	EUDI-PLOB-1200	918.44	
						2 Power Receptacles, 1 Data Port	EUDI-PLOB-2010	706.80	
						2 Power Receptacles, 1 Smart USB-A+C Charging	EUDI-PLOB-2100	812.62	
						3 Power Receptacles	EUDI-PLOB-3000	706.80	
						4	1 Power Receptacle, 1 Data Port, 1 Cable Bay	EUDI-PLOB-1012	\$ 706.80
							1 Power Receptacle, 3 Data Ports	EUDI-PLOB-1030	706.80
					1 Power Receptacle, 1 Smart USB-A+C Charging, 1 Cable Bay		EUDI-PLOB-1102	812.62	
					1 Power Receptacle, 3 Smart USB-A+C Charging		EUDI-PLOB-1300	1024.26	
					2 Power Receptacles, 1 Cable Bay		EUDI-PLOB-2002	706.80	
					2 Power Receptacles, 2 Data Ports		EUDI-PLOB-2020	706.80	
					2 Power Receptacles, 1 Smart USB-A+C Charging, 1 Data Port		EUDI-PLOB-2110	812.62	
					2 Power Receptacles, 2 Smart USB-A+C Charging		EUDI-PLOB-2200	918.44	
					3 Power Receptacles, 1 Data Port		EUDI-PLOB-3010	706.80	
					3 Power Receptacles, 1 Smart USB-A+C Charging		EUDI-PLOB-3100	812.62	
					4 Power Receptacles		EUDI-PLOB-4000	706.80	
					6		1 Power Receptacle, 1 Smart USB-A+C Charging, 2 Cable Bays	EUDI-PLOB-1104	\$ 904.32
							1 Power Receptacle, 1 Smart USB-A+C Charging, 2 Data Ports, 1 Cable Bay	EUDI-PLOB-1122	904.32
							1 Power Receptacle, 1 Smart USB-A+C Charging, 4 Data Ports	EUDI-PLOB-1140	904.32
							1 Power Receptacle, 2 Smart USB-A+C Charging, 1 Data Port, 1 Cable Bay	EUDI-PLOB-1212	1010.14
						1 Power Receptacle, 2 Smart USB-A+C Charging, 3 Data Ports	EUDI-PLOB-1230	1010.14	
						1 Power Receptacle, 3 Smart USB-A+C Charging, 1 Cable Bay	EUDI-PLOB-1302	1115.96	
						1 Power Receptacle, 3 Smart USB-A+C Charging, 2 Data Ports	EUDI-PLOB-1320	1115.96	
						1 Power Receptacle, 4 Smart USB-A+C Charging, 1 Data Port	EUDI-PLOB-1410	1221.78	
						2 Power Receptacles, 2 Cable Bays	EUDI-PLOB-2004	798.50	
						2 Power Receptacles, 2 Data Ports, 1 Cable Bay	EUDI-PLOB-2022	798.50	
						2 Power Receptacles, 4 Data Ports	EUDI-PLOB-2040	798.50	
						2 Power Receptacles, 1 Smart USB-A+C Charging, 1 Data Port, 1 Cable Bay	EUDI-PLOB-2112	904.32	
						2 Power Receptacles, 1 Smart USB-A+C Charging, 3 Data Ports	EUDI-PLOB-2130	904.32	
						2 Power Receptacles, 2 Smart USB-A+C Charging, 1 Cable Bay	EUDI-PLOB-2202	1010.14	
						2 Power Receptacles, 2 Smart USB-A+C Charging, 2 Data Ports	EUDI-PLOB-2220	1010.14	
2 Power Receptacles, 3 Smart USB-A+C Charging, 1 Data Port	EUDI-PLOB-2310	1115.96							
2 Power Receptacles, 4 Smart USB-A+C Charging	EUDI-PLOB-2400	1221.78							
3 Power Receptacles, 3 Data Ports	EUDI-PLOB-3030	798.50							
3 Power Receptacles, 1 Smart USB-A+C Charging, 1 Cable Bay	EUDI-PLOB-3102	904.32							
3 Power Receptacles, 1 Smart USB-A+C Charging, 2 Data Ports	EUDI-PLOB-3120	904.32							
3 Power Receptacles, 2 Smart USB-A+C Charging, 1 Data Port	EUDI-PLOB-3210	1010.14							
3 Power Receptacles, 3 Smart USB-A+C Charging	EUDI-PLOB-3300	1115.96							
4 Power Receptacles, 1 Cable Bay	EUDI-PLOB-4002	798.50							
4 Power Receptacles, 2 Data Ports	EUDI-PLOB-4020	798.50							
4 Power Receptacles, 1 Smart USB-A+C Charging, 1 Data Port	EUDI-PLOB-4110	904.32							
4 Power Receptacles, 2 Smart USB-A+C Charging	EUDI-PLOB-4200	1010.14							
5 Power Receptacles, 1 Data Port	EUDI-PLOB-5010	798.50							
5 Power Receptacles, 1 Smart USB-A+C Charging	EUDI-PLOB-5100	904.32							
6 Power Receptacles	EUDI-PLOB-6000	798.50							

Worksurface Power Modules — Enhanced Power Corded

Top Depth	Top Width	Cord Length	Housing Color	Port Color	Port	Configuration	Number	Price	
3"(76mm)	9.5"(241mm)	12'(3658mm)	Clear Anodized	White	3	1 Power Receptacle, 1 Cable Bay	EUDI-PLOW-1002	\$ 523.39	
						1 Power Receptacle, 2 Data Ports	EUDI-PLOW-1020	523.39	
						1 Power Receptacle, 1 Data Port, 1 Smart USB-A+C Charging	EUDI-PLOW-1110	629.21	
						1 Power Receptacle, 2 Smart USB-A+C Charging	EUDI-PLOW-1200	735.03	
						2 Power Receptacles, 1 Data Port	EUDI-PLOW-2010	523.39	
						2 Power Receptacles, 1 Smart USB-A+C Charging	EUDI-PLOW-2100	629.21	
						3 Power Receptacles	EUDI-PLOW-3000	523.39	
						4	1 Power Receptacle, 1 Data Port, 1 Cable Bay	EUDI-PLOW-1012	\$ 523.39
							1 Power Receptacle, 3 Data Ports	EUDI-PLOW-1030	523.39
					1 Power Receptacle, 1 Smart USB-A+C Charging, 1 Cable Bay		EUDI-PLOW-1102	629.21	
					1 Power Receptacle, 3 Smart USB-A+C Charging		EUDI-PLOW-1300	840.85	
					2 Power Receptacles, 1 Cable Bay		EUDI-PLOW-2002	523.39	
					2 Power Receptacles, 2 Data Ports		EUDI-PLOW-2020	523.39	
					2 Power Receptacles, 1 Smart USB-A+C Charging, 1 Data Port		EUDI-PLOW-2110	629.21	
					2 Power Receptacles, 2 Smart USB-A+C Charging		EUDI-PLOW-2200	735.03	
					3 Power Receptacles, 1 Data Port		EUDI-PLOW-3010	523.39	
					3 Power Receptacles, 1 Smart USB-A+C Charging		EUDI-PLOW-3100	629.21	
					4 Power Receptacles		EUDI-PLOW-4000	523.39	
					6	1 Power Receptacle, 1 Smart USB-A+C Charging, 2 Cable Bays	EUDI-PLOW-1104	\$ 720.91	
						1 Power Receptacle, 1 Smart USB-A+C Charging, 2 Data Ports, 1 Cable Bay	EUDI-PLOW-1122	720.91	
						1 Power Receptacle, 1 Smart USB-A+C Charging, 4 Data Ports	EUDI-PLOW-1140	720.91	
						1 Power Receptacle, 2 Smart USB-A+C Charging, 1 Data Port, 1 Cable Bay	EUDI-PLOW-1212	826.73	
						1 Power Receptacle, 2 Smart USB-A+C Charging, 3 Data Ports	EUDI-PLOW-1230	826.73	
						1 Power Receptacle, 3 Smart USB-A+C Charging, 1 Cable Bay	EUDI-PLOW-1302	932.55	
						1 Power Receptacle, 3 Smart USB-A+C Charging, 2 Data Ports	EUDI-PLOW-1320	932.55	
						1 Power Receptacle, 4 Smart USB-A+C Charging, 1 Data Port	EUDI-PLOW-1410	1038.37	
						2 Power Receptacles, 2 Cable Bays	EUDI-PLOW-2004	615.09	
						2 Power Receptacles, 2 Data Ports, 1 Cable Bay	EUDI-PLOW-2022	615.09	
						2 Power Receptacles, 4 Data Ports	EUDI-PLOW-2040	615.09	
						2 Power Receptacles, 1 Smart USB-A+C Charging, 1 Data Port, 1 Cable Bay	EUDI-PLOW-2112	720.91	
2 Power Receptacles, 1 Smart USB-A+C Charging, 3 Data Ports	EUDI-PLOW-2130	720.91							
2 Power Receptacles, 2 Smart USB-A+C Charging, 1 Cable Bay	EUDI-PLOW-2202	826.73							
2 Power Receptacles, 2 Smart USB-A+C Charging, 2 Data Ports	EUDI-PLOW-2220	826.73							
2 Power Receptacles, 3 Smart USB-A+C Charging, 1 Data Port	EUDI-PLOW-2310	932.55							
2 Power Receptacles, 4 Smart USB-A+C Charging	EUDI-PLOW-2400	1038.37							
3 Power Receptacles, 3 Data Ports	EUDI-PLOW-3030	615.09							
3 Power Receptacles, 1 Smart USB-A+C Charging, 1 Cable Bay	EUDI-PLOW-3102	720.91							
3 Power Receptacles, 1 Smart USB-A+C Charging, 2 Data Ports	EUDI-PLOW-3120	720.91							
3 Power Receptacles, 2 Smart USB-A+C Charging, 1 Data Port	EUDI-PLOW-3210	826.73							
3 Power Receptacles, 3 Smart USB-A+C Charging	EUDI-PLOW-3300	932.55							
4 Power Receptacles, 1 Cable Bay	EUDI-PLOW-4002	615.09							
4 Power Receptacles, 2 Data Ports	EUDI-PLOW-4020	615.09							
4 Power Receptacles, 1 Smart USB-A+C Charging, 1 Data Port	EUDI-PLOW-4110	720.91							
4 Power Receptacles, 2 Smart USB-A+C Charging	EUDI-PLOW-4200	826.73							
5 Power Receptacles, 1 Data Port	EUDI-PLOW-5010	615.09							
5 Power Receptacles, 1 Smart USB-A+C Charging	EUDI-PLOW-5100	720.91							
6 Power Receptacles	EUDI-PLOW-6000	615.09							

Worksurface Power Modules — Enhanced Power Hardware

3-Port:

- (2) Power
- (1) Smart USB-A+C

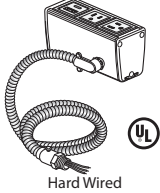

EUDI-HFOB-2010

4-Port:

- (2) Power
- (1) Smart USB-A+C
- (1) Data

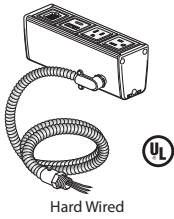

EUDI-HFOB-2110

6-Port:

- (2) Power
- (1) Smart USB-A+C
- (1) Data
- (1) Cable Bay

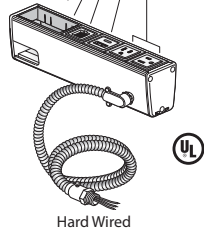

EUDI-HFOB-2112

Class YA

Features

- Includes power module with 3, 4 or 6 ports that can be configured with simplex outlets (NEMA-5-15R), USB charging port (Smart USB-A+C), data ports or cable bay(s) that can accept up to two pull out data/AV cables and mounting hardware.
- Data port accommodate most varieties of field supplied data/ AV jacks.
- Attaches to surface with use of separately specified mounting brackets.
- Hardwired power module with 6'(1829mm) or 12'(3658mm) long flexible metal conduit feed, 0.5"(13mm) conduit fitting and wires for hardwire connection.
- The Smart USB-A+C allows for the 20W to be transferred between the 2 ports. If the USB-A is being used, the full wattage is sent to the USB-A, and the same for the USB-C. If both are being used, the wattage is distributed to each port and the port drawing the most power will receive more watts than the one that is not.
- Color option of black anodized housing with black receptacles or clear anodized housing with white receptacles.

Specification Tips

- **Configuration and quantity of power and data ports cannot be modified in the field.**
- **For use with 120 volt 60 hertz power source only.**
- Separately specify attachment hardware for desired application.
- Requires field installation.
- Specify AV cables separately.
- Cable Bay requires cables less than 0.3"(8mm) diameter.
- Application may require approval of local authority having jurisdiction (AHJ); ensure compliance before placing orders and installation.

To Order, Specify:

- 1) Product number.
(No finish specification required.)

Worksurface Power Modules — Enhanced Power Hardware

Top Depth	Top Width	Conduit Length	Housing Color	Port Color	Port	Configuration	Number	Price						
3"(76mm)	5"(127mm)	6"(1829mm)	Black Anodized	Black	3	1 Power Receptacle, 1 Cable Bay	EUDI-HFOB-1002	\$ 728.66						
						1 Power Receptacle, 2 Data Ports	EUDI-HFOB-1020	728.66						
						1 Power Receptacle, 1 Data Port, 1 Smart USB-A+C Charging	EUDI-HFOB-1110	834.48						
						1 Power Receptacle, 2 Smart USB-A+C Charging	EUDI-HFOB-1200	940.30						
						2 Power Receptacles, 1 Data Port	EUDI-HFOB-2010	728.66						
						2 Power Receptacles, 1 Smart USB-A+C Charging	EUDI-HFOB-2100	834.48						
						3 Power Receptacles	EUDI-HFOB-3000	728.66						
3"(76mm)	6.5"(165mm)				4	1 Power Receptacle, 1 Data Port, 1 Cable Bay	EUDI-HFOB-1012	\$ 728.66						
						1 Power Receptacle, 3 Data Ports	EUDI-HFOB-1030	728.66						
						1 Power Receptacle, 1 Smart USB-A+C Charging, 1 Cable Bay	EUDI-HFOB-1102	834.48						
						1 Power Receptacle, 3 Smart USB-A+C Charging	EUDI-HFOB-1300	1046.12						
						2 Power Receptacles, 1 Cable Bay	EUDI-HFOB-2002	728.66						
						2 Power Receptacles, 2 Data Ports	EUDI-HFOB-2020	728.66						
						2 Power Receptacles, 1 Smart USB-A+C Charging, 1 Data Port	EUDI-HFOB-2110	834.48						
						2 Power Receptacles, 2 Smart USB-A+C Charging	EUDI-HFOB-2200	940.30						
						3 Power Receptacles, 1 Data Port	EUDI-HFOB-3010	728.66						
						3 Power Receptacles, 1 Smart USB-A+C Charging	EUDI-HFOB-3100	834.48						
						4 Power Receptacles	EUDI-HFOB-4000	728.66						
						3"(76mm)	9.5"(241mm)				6	1 Power Receptacle, 1 Smart USB-A+C Charging, 2 Cable Bays	EUDI-HFOB-1104	\$ 926.18
												1 Power Receptacle, 1 Smart USB-A+C Charging, 2 Data Ports, 1 Cable Bay	EUDI-HFOB-1122	926.18
1 Power Receptacle, 1 Smart USB-A+C Charging, 4 Data Ports	EUDI-HFOB-1140	926.18												
1 Power Receptacle, 2 Smart USB-A+C Charging, 1 Data Port, 1 Cable Bay	EUDI-HFOB-1212	1032.00												
1 Power Receptacle, 2 Smart USB-A+C Charging, 3 Data Ports	EUDI-HFOB-1230	1032.00												
1 Power Receptacle, 3 Smart USB-A+C Charging, 1 Cable Bay	EUDI-HFOB-1302	1137.82												
1 Power Receptacle, 3 Smart USB-A+C Charging, 2 Data Ports	EUDI-HFOB-1320	1137.82												
1 Power Receptacle, 4 Smart USB-A+C Charging, 1 Data Port	EUDI-HFOB-1410	1243.64												
2 Power Receptacles, 2 Cable Bays	EUDI-HFOB-2004	820.36												
2 Power Receptacles, 2 Data Ports, 1 Cable Bay	EUDI-HFOB-2022	820.36												
2 Power Receptacles, 4 Data Ports	EUDI-HFOB-2040	820.36												
2 Power Receptacles, 1 Smart USB-A+C Charging, 1 Data Port, 1 Cable Bay	EUDI-HFOB-2112	926.18												
2 Power Receptacles, 1 Smart USB-A+C Charging, 3 Data Ports	EUDI-HFOB-2130	926.18												
2 Power Receptacles, 2 Smart USB-A+C Charging, 1 Cable Bay	EUDI-HFOB-2202	1032.00												
2 Power Receptacles, 2 Smart USB-A+C Charging, 2 Data Ports	EUDI-HFOB-2220	1032.00												
2 Power Receptacles, 3 Smart USB-A+C Charging, 1 Data Port	EUDI-HFOB-2310	1137.82												
2 Power Receptacles, 4 Smart USB-A+C Charging	EUDI-HFOB-2400	1243.64												
3 Power Receptacles, 3 Data Ports	EUDI-HFOB-3030	820.36												
3 Power Receptacles, 1 Smart USB-A+C Charging, 1 Cable Bay	EUDI-HFOB-3102	926.18												
3 Power Receptacles, 1 Smart USB-A+C Charging, 2 Data Ports	EUDI-HFOB-3120	926.18												
3 Power Receptacles, 2 Smart USB-A+C Charging, 1 Data Port	EUDI-HFOB-3210	1032.00												
3 Power Receptacles, 3 Smart USB-A+C Charging	EUDI-HFOB-3300	1137.82												
4 Power Receptacles, 1 Cable Bay	EUDI-HFOB-4002	820.36												
4 Power Receptacles, 2 Data Ports	EUDI-HFOB-4020	820.36												
4 Power Receptacles, 1 Smart USB-A+C Charging, 1 Data Port	EUDI-HFOB-4110	926.18												
4 Power Receptacles, 2 Smart USB-A+C Charging	EUDI-HFOB-4200	1032.00												
5 Power Receptacles, 1 Data Port	EUDI-HFOB-5010	820.36												
5 Power Receptacles, 1 Smart USB-A+C Charging	EUDI-HFOB-5100	926.18												
6 Power Receptacles	EUDI-HFOB-6000	820.36												

Worksurface Power Modules — Enhanced Power Hardware

Top Depth	Top Width	Conduit Length	Housing Color	Port Color	Port	Configuration	Number	Price						
3"(76mm)	5"(127mm)	6"(152mm)	Clear Anodized	White	3	1 Power Receptacle, 1 Cable Bay	EUDI-HFOW-1002	\$ 545.25						
						1 Power Receptacle, 2 Data Ports	EUDI-HFOW-1020	545.25						
						1 Power Receptacle, 1 Data Port, 1 Smart USB-A+C Charging	EUDI-HFOW-1110	651.07						
						1 Power Receptacle, 2 Smart USB-A+C Charging	EUDI-HFOW-1200	756.89						
						2 Power Receptacles, 1 Data Port	EUDI-HFOW-2010	545.25						
						2 Power Receptacles, 1 Smart USB-A+C Charging	EUDI-HFOW-2100	651.07						
						3 Power Receptacles	EUDI-HFOW-3000	545.25						
3"(76mm)	6.5"(165mm)				4	1 Power Receptacle, 1 Data Port, 1 Cable Bay	EUDI-HFOW-1012	\$ 545.25						
						1 Power Receptacle, 3 Data Ports	EUDI-HFOW-1030	545.25						
						1 Power Receptacle, 1 Smart USB-A+C Charging, 1 Cable Bay	EUDI-HFOW-1102	651.07						
						1 Power Receptacle, 3 Smart USB-A+C Charging	EUDI-HFOW-1300	862.71						
						2 Power Receptacles, 1 Cable Bay	EUDI-HFOW-2002	545.25						
						2 Power Receptacles, 2 Data Ports	EUDI-HFOW-2020	545.25						
						2 Power Receptacles, 1 Smart USB-A+C Charging, 1 Data Port	EUDI-HFOW-2110	651.07						
						2 Power Receptacles, 2 Smart USB-A+C Charging	EUDI-HFOW-2200	756.89						
						3 Power Receptacles, 1 Data Port	EUDI-HFOW-3010	545.25						
						3 Power Receptacles, 1 Smart USB-A+C Charging	EUDI-HFOW-3100	651.07						
						4 Power Receptacles	EUDI-HFOW-4000	545.25						
						3"(76mm)	9.5"(241mm)				6	1 Power Receptacle, 1 Smart USB-A+C Charging, 2 Cable Bays	EUDI-HFOW-1104	\$ 742.77
												1 Power Receptacle, 1 Smart USB-A+C Charging, 2 Data Ports, 1 Cable Bay	EUDI-HFOW-1122	742.77
1 Power Receptacle, 1 Smart USB-A+C Charging, 4 Data Ports	EUDI-HFOW-1140	742.77												
1 Power Receptacle, 2 Smart USB-A+C Charging, 1 Data Port, 1 Cable Bay	EUDI-HFOW-1212	848.59												
1 Power Receptacle, 2 Smart USB-A+C Charging, 3 Data Ports	EUDI-HFOW-1230	848.59												
1 Power Receptacle, 3 Smart USB-A+C Charging, 1 Cable Bay	EUDI-HFOW-1302	954.41												
1 Power Receptacle, 3 Smart USB-A+C Charging, 2 Data Ports	EUDI-HFOW-1320	954.41												
1 Power Receptacle, 4 Smart USB-A+C Charging, 1 Data Port	EUDI-HFOW-1410	1060.23												
2 Power Receptacles, 2 Cable Bays	EUDI-HFOW-2004	636.95												
2 Power Receptacles, 2 Data Ports, 1 Cable Bay	EUDI-HFOW-2022	636.95												
2 Power Receptacles, 4 Data Ports	EUDI-HFOW-2040	636.95												
2 Power Receptacles, 1 Smart USB-A+C Charging, 1 Data Port, 1 Cable Bay	EUDI-HFOW-2112	742.77												
2 Power Receptacles, 1 Smart USB-A+C Charging, 3 Data Ports	EUDI-HFOW-2130	742.77												
2 Power Receptacles, 2 Smart USB-A+C Charging, 1 Cable Bay	EUDI-HFOW-2202	848.59												
2 Power Receptacles, 2 Smart USB-A+C Charging, 2 Data Ports	EUDI-HFOW-2220	848.59												
2 Power Receptacles, 3 Smart USB-A+C Charging, 1 Data Port	EUDI-HFOW-2310	954.41												
2 Power Receptacles, 4 Smart USB-A+C Charging	EUDI-HFOW-2400	1060.23												
3 Power Receptacles, 3 Data Ports	EUDI-HFOW-3030	636.95												
3 Power Receptacles, 1 Smart USB-A+C Charging, 1 Cable Bay	EUDI-HFOW-3102	742.77												
3 Power Receptacles, 1 Smart USB-A+C Charging, 2 Data Ports	EUDI-HFOW-3120	742.77												
3 Power Receptacles, 2 Smart USB-A+C Charging, 1 Data Port	EUDI-HFOW-3210	848.59												
3 Power Receptacles, 3 Smart USB-A+C Charging	EUDI-HFOW-3300	954.41												
4 Power Receptacles, 1 Cable Bay	EUDI-HFOW-4002	636.95												
4 Power Receptacles, 2 Data Ports	EUDI-HFOW-4020	636.95												
4 Power Receptacles, 1 Smart USB-A+C Charging, 1 Data Port	EUDI-HFOW-4110	742.77												
4 Power Receptacles, 2 Smart USB-A+C Charging	EUDI-HFOW-4200	848.59												
5 Power Receptacles, 1 Data Port	EUDI-HFOW-5010	636.95												
5 Power Receptacles, 1 Smart USB-A+C Charging	EUDI-HFOW-5100	742.77												
6 Power Receptacles	EUDI-HFOW-6000	636.95												

Worksurface Power Modules — Enhanced Power Hardware

Top Depth	Top Width	Conduit Length	Housing Color	Port Color	Port	Configuration	Number	Price						
3"(76mm)	5"(127mm)	12"(305mm)	Black Anodized	Black	3	1 Power Receptacle, 1 Cable Bay	EUDI-HLOB-1002	\$ 814.87						
						1 Power Receptacle, 2 Data Ports	EUDI-HLOB-1020	814.87						
						1 Power Receptacle, 1 Data Port, 1 Smart USB-A+C Charging	EUDI-HLOB-1110	920.69						
						1 Power Receptacle, 2 Smart USB-A+C Charging	EUDI-HLOB-1200	1026.51						
						2 Power Receptacles, 1 Data Port	EUDI-HLOB-2010	814.87						
						2 Power Receptacles, 1 Smart USB-A+C Charging	EUDI-HLOB-2100	920.69						
						3 Power Receptacles	EUDI-HLOB-3000	814.87						
3"(76mm)	6.5"(165mm)				4	1 Power Receptacle, 1 Data Port, 1 Cable Bay	EUDI-HLOB-1012	\$ 814.87						
						1 Power Receptacle, 3 Data Ports	EUDI-HLOB-1030	814.87						
						1 Power Receptacle, 1 Smart USB-A+C Charging, 1 Cable Bay	EUDI-HLOB-1102	920.69						
						1 Power Receptacle, 3 Smart USB-A+C Charging	EUDI-HLOB-1300	1132.33						
						2 Power Receptacles, 1 Cable Bay	EUDI-HLOB-2002	814.87						
						2 Power Receptacles, 2 Data Ports	EUDI-HLOB-2020	814.87						
						2 Power Receptacles, 1 Smart USB-A+C Charging, 1 Data Port	EUDI-HLOB-2110	920.69						
						2 Power Receptacles, 2 Smart USB-A+C Charging	EUDI-HLOB-2200	1026.51						
						3 Power Receptacles, 1 Data Port	EUDI-HLOB-3010	814.87						
						3 Power Receptacles, 1 Smart USB-A+C Charging	EUDI-HLOB-3100	920.69						
						4 Power Receptacles	EUDI-HLOB-4000	814.87						
						3"(76mm)	9.5"(241mm)				6	1 Power Receptacle, 1 Smart USB-A+C Charging, 2 Cable Bays	EUDI-HLOB-1104	\$ 1012.39
												1 Power Receptacle, 1 Smart USB-A+C Charging, 2 Data Ports, 1 Cable Bay	EUDI-HLOB-1122	1012.39
1 Power Receptacle, 1 Smart USB-A+C Charging, 4 Data Ports	EUDI-HLOB-1140	1012.39												
1 Power Receptacle, 2 Smart USB-A+C Charging, 1 Data Port, 1 Cable Bay	EUDI-HLOB-1212	1118.21												
1 Power Receptacle, 2 Smart USB-A+C Charging, 3 Data Ports	EUDI-HLOB-1230	1118.21												
1 Power Receptacle, 3 Smart USB-A+C Charging, 1 Cable Bay	EUDI-HLOB-1302	1224.03												
1 Power Receptacle, 3 Smart USB-A+C Charging, 2 Data Ports	EUDI-HLOB-1320	1224.03												
1 Power Receptacle, 4 Smart USB-A+C Charging, 1 Data Port	EUDI-HLOB-1410	1329.85												
2 Power Receptacles, 2 Cable Bays	EUDI-HLOB-2004	906.57												
2 Power Receptacles, 2 Data Ports, 1 Cable Bay	EUDI-HLOB-2022	906.57												
2 Power Receptacles, 4 Data Ports	EUDI-HLOB-2040	906.57												
2 Power Receptacles, 1 Smart USB-A+C Charging, 1 Data Port, 1 Cable Bay	EUDI-HLOB-2112	1012.39												
2 Power Receptacles, 1 Smart USB-A+C Charging, 3 Data Ports	EUDI-HLOB-2130	1012.39												
2 Power Receptacles, 2 Smart USB-A+C Charging, 1 Cable Bay	EUDI-HLOB-2202	1118.21												
2 Power Receptacles, 2 Smart USB-A+C Charging, 2 Data Ports	EUDI-HLOB-2220	1118.21												
2 Power Receptacles, 3 Smart USB-A+C Charging, 1 Data Port	EUDI-HLOB-2310	1224.03												
2 Power Receptacles, 4 Smart USB-A+C Charging	EUDI-HLOB-2400	1329.85												
3 Power Receptacles, 3 Data Ports	EUDI-HLOB-3030	906.57												
3 Power Receptacles, 1 Smart USB-A+C Charging, 1 Cable Bay	EUDI-HLOB-3102	1012.39												
3 Power Receptacles, 1 Smart USB-A+C Charging, 2 Data Ports	EUDI-HLOB-3120	1012.39												
3 Power Receptacles, 2 Smart USB-A+C Charging, 1 Data Port	EUDI-HLOB-3210	1118.21												
3 Power Receptacles, 3 Smart USB-A+C Charging	EUDI-HLOB-3300	1224.03												
4 Power Receptacles, 1 Cable Bay	EUDI-HLOB-4002	906.57												
4 Power Receptacles, 2 Data Ports	EUDI-HLOB-4020	906.57												
4 Power Receptacles, 1 Smart USB-A+C Charging, 1 Data Port	EUDI-HLOB-4110	1012.39												
4 Power Receptacles, 2 Smart USB-A+C Charging	EUDI-HLOB-4200	1118.21												
5 Power Receptacles, 1 Data Port	EUDI-HLOB-5010	906.57												
5 Power Receptacles, 1 Smart USB-A+C Charging	EUDI-HLOB-5100	1012.39												
6 Power Receptacles	EUDI-HLOB-6000	906.57												

Worksurface Power Modules — Enhanced Power Hardware

Top Depth	Top Width	Conduit Length	Housing Color	Port Color	Port	Configuration	Number	Price						
3"(76mm)	5"(127mm)	12"(305mm)	Clear Anodized	White	3	1 Power Receptacle, 1 Cable Bay	EUDI-HLOW-1002	\$ 631.46						
						1 Power Receptacle, 2 Data Ports	EUDI-HLOW-1020	631.46						
						1 Power Receptacle, 1 Data Port, 1 Smart USB-A+C Charging	EUDI-HLOW-1110	737.28						
						1 Power Receptacle, 2 Smart USB-A+C Charging	EUDI-HLOW-1200	843.10						
						2 Power Receptacles, 1 Data Port	EUDI-HLOW-2010	631.46						
						2 Power Receptacles, 1 Smart USB-A+C Charging	EUDI-HLOW-2100	737.28						
						3 Power Receptacles	EUDI-HLOW-3000	631.46						
3"(76mm)	6.5"(165mm)				4	1 Power Receptacle, 1 Data Port, 1 Cable Bay	EUDI-HLOW-1012	\$ 631.46						
						1 Power Receptacle, 3 Data Ports	EUDI-HLOW-1030	631.46						
						1 Power Receptacle, 1 Smart USB-A+C Charging, 1 Cable Bay	EUDI-HLOW-1102	737.28						
						1 Power Receptacle, 3 Smart USB-A+C Charging	EUDI-HLOW-1300	948.92						
						2 Power Receptacles, 1 Cable Bay	EUDI-HLOW-2002	631.46						
						2 Power Receptacles, 2 Data Ports	EUDI-HLOW-2020	631.46						
						2 Power Receptacles, 1 Smart USB-A+C Charging, 1 Data Port	EUDI-HLOW-2110	737.28						
						2 Power Receptacles, 2 Smart USB-A+C Charging	EUDI-HLOW-2200	843.10						
						3 Power Receptacles, 1 Data Port	EUDI-HLOW-3010	631.46						
						3 Power Receptacles, 1 Smart USB-A+C Charging	EUDI-HLOW-3100	737.28						
						4 Power Receptacles	EUDI-HLOW-4000	631.46						
						3"(76mm)	9.5"(241mm)				6	1 Power Receptacle, 1 Smart USB-A+C Charging, 2 Cable Bays	EUDI-HLOW-1104	\$ 828.98
												1 Power Receptacle, 1 Smart USB-A+C Charging, 2 Data Ports, 1 Cable Bay	EUDI-HLOW-1122	828.98
1 Power Receptacle, 1 Smart USB-A+C Charging, 4 Data Ports	EUDI-HLOW-1140	828.98												
1 Power Receptacle, 2 Smart USB-A+C Charging, 1 Data Port, 1 Cable Bay	EUDI-HLOW-1212	934.80												
1 Power Receptacle, 2 Smart USB-A+C Charging, 3 Data Ports	EUDI-HLOW-1230	934.80												
1 Power Receptacle, 3 Smart USB-A+C Charging, 1 Cable Bay	EUDI-HLOW-1302	1040.62												
1 Power Receptacle, 3 Smart USB-A+C Charging, 2 Data Ports	EUDI-HLOW-1320	1040.62												
1 Power Receptacle, 4 Smart USB-A+C Charging, 1 Data Port	EUDI-HLOW-1410	1146.44												
2 Power Receptacles, 2 Cable Bays	EUDI-HLOW-2004	723.16												
2 Power Receptacles, 2 Data Ports, 1 Cable Bay	EUDI-HLOW-2022	723.16												
2 Power Receptacles, 4 Data Ports	EUDI-HLOW-2040	723.16												
2 Power Receptacles, 1 Smart USB-A+C Charging, 1 Data Port, 1 Cable Bay	EUDI-HLOW-2112	828.98												
2 Power Receptacles, 1 Smart USB-A+C Charging, 3 Data Ports	EUDI-HLOW-2130	828.98												
2 Power Receptacles, 2 Smart USB-A+C Charging, 1 Cable Bay	EUDI-HLOW-2202	934.80												
2 Power Receptacles, 2 Smart USB-A+C Charging, 2 Data Ports	EUDI-HLOW-2220	934.80												
2 Power Receptacles, 3 Smart USB-A+C Charging, 1 Data Port	EUDI-HLOW-2310	1040.62												
2 Power Receptacles, 4 Smart USB-A+C Charging	EUDI-HLOW-2400	1146.44												
3 Power Receptacles, 3 Data Ports	EUDI-HLOW-3030	723.16												
3 Power Receptacles, 1 Smart USB-A+C Charging, 1 Cable Bay	EUDI-HLOW-3102	828.98												
3 Power Receptacles, 1 Smart USB-A+C Charging, 2 Data Ports	EUDI-HLOW-3120	828.98												
3 Power Receptacles, 2 Smart USB-A+C Charging, 1 Data Port	EUDI-HLOW-3210	934.80												
3 Power Receptacles, 3 Smart USB-A+C Charging	EUDI-HLOW-3300	1040.62												
4 Power Receptacles, 1 Cable Bay	EUDI-HLOW-4002	723.16												
4 Power Receptacles, 2 Data Ports	EUDI-HLOW-4020	723.16												
4 Power Receptacles, 1 Smart USB-A+C Charging, 1 Data Port	EUDI-HLOW-4110	828.98												
4 Power Receptacles, 2 Smart USB-A+C Charging	EUDI-HLOW-4200	934.80												
5 Power Receptacles, 1 Data Port	EUDI-HLOW-5010	723.16												
5 Power Receptacles, 1 Smart USB-A+C Charging	EUDI-HLOW-5100	828.98												
6 Power Receptacles	EUDI-HLOW-6000	723.16												

Worksurface Power Modules — Enhanced Power

Spiral Corded — Height Adjustable

4-Port:

- (2) Power
- (1) Smart USB-A+C
- (1) Data

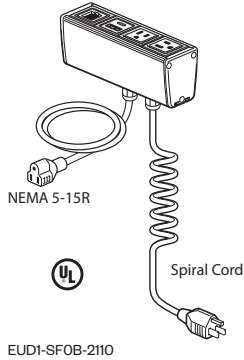

Features

- Includes power module with 3, 4 or 6 ports that can be configured with simplex outlets (NEMA-5-15R), USB charging port (Smart USB-A+C), data ports or cable bay(s) that can accept up to two pull out data/AV cables and mounting hardware.
- Data port accommodate most varieties of field supplied data/ AV jacks.
- Spiral Cord includes 15 amp plug (NEMA 5-15P) and expands to 12'(3658mm) when stretched.
- Auxiliary 24"(610mm) power cord with NEMA 5-15R used to provide power to table motor controller.
- Attaches to surface with use of separately specified mounting brackets.
- The Smart USB-A+C allows for the 20W to be transferred between the 2 ports. If the USB-A is being used, the full wattage is sent to the USB-A, and the same for the USB-C. If both are being used, the wattage is distributed to each port and the port drawing the most power will receive more watts than the one that is not.
- Color option of black anodized housing with black receptacles or clear anodized housing with white receptacles.

To Order, Specify:

- 1) Product number.
(No finish specification required.)

Specification Tips

- **Configuration and quantity of power and data ports cannot be modified in the field.**
- **For use with 120 volt 60 hertz power source only.**
- **For use with:**
 - Planes or Planes LT Model Height Adjustable Tables
 - Planes or Planes LT Model Height Adjustable Bench
 - Upside+ or Upside Model Height Adjustable Tables
- Separately specify attachment hardware for desired application.
- Not for use with cable chain.
- Requires field installation.
- Application may require approval of local authority having jurisdiction (AHJ); ensure compliance before placing orders and installation.

4-Port:

- (4) Power

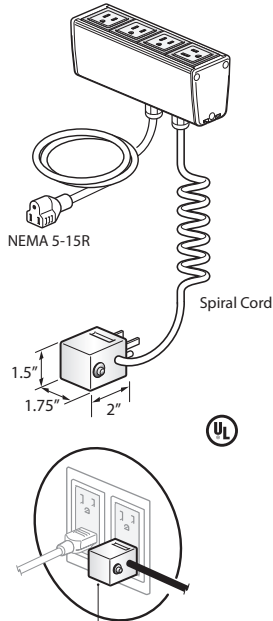

NOTE:
Always Circuit Breaker Plug when more than 3 power outlets specified.

EUDI-SFOB-4000
Class YA

Top Depth	Top Width	Cord Length	Housing Color	Port Color	Port	Configuration	Number	Price
3"(76mm)	6.5"(165mm)	10'(3048mm)- 12'(3658mm)	Black Anodized	Black	4	2 Power Receptacles, 1 Smart USB-A+C Charging, 1 Data Port	EUDI-SFOB-2110	\$ 1120.75
					4	2 Power Receptacles, 2 Smart USB-A+C Charging	EUDI-SFOB-2200	1226.57
					4	3 Power Receptacles, 1 Data Port	EUDI-SFOB-3010	1014.93
					4	3 Power Receptacles, 1 Smart USB-A+C Charging	EUDI-SFOB-3100	1120.75
					4	4 Power Receptacles	EUDI-SFOB-4000	1014.93
					4	2 Power Receptacles, 1 Smart USB-A+C Charging, 1 Data Port	EUDI-SFOW-2110	\$ 937.34
					4	2 Power Receptacles, 2 Smart USB-A+C Charging	EUDI-SFOW-2200	1043.16
					4	3 Power Receptacles, 1 Data Port	EUDI-SFOW-3010	831.52
			Clear Anodized	White	4	3 Power Receptacles, 1 Smart USB-A+C Charging	EUDI-SFOW-3100	937.34
					4	4 Power Receptacles	EUDI-SFOW-4000	831.52

Worksurface Power Modules — Enhanced Power Cord for Height Adjustable

4-Port:

- (2) Power
- (1) Smart USB-A+C
- (1) Data

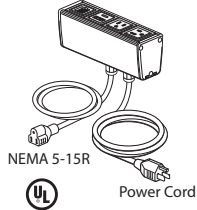

EUDI-SLOB-2110

4-Port:

- (4) Power

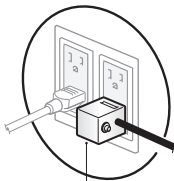
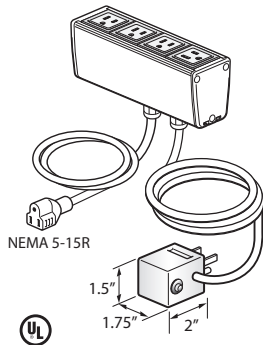

NOTE: Always Circuit Breaker Plug when more than 3 power outlets specified.

EUDI-SLOB-4000

Class YA

Features

- Includes power module with 3, 4 or 6 ports that can be configured with simplex outlets (NEMA-5-15R), USB charging port (Smart USB-A+C) , data ports or cable bay(s) that can accept up to two pull out data/AV cables and mounting hardware.
- Data port accommodate most varieties of field supplied data/ AV jacks.
- Corded power module with 15 amp - 12'(3658mm) long cord with plug (NEMA 5-15P).
- Auxiliary 24"(610mm) power cord with NEMA 5-15R used to provide power to table motor controller.
- Attaches to surface with use of separately specified mounting brackets.
- The Smart USB-A+C allows for the 20W to be transferred between the 2 ports. If the USB-A is being used, the full wattage is sent to the USB-A, and the same for the USB-C. If both are being used, the wattage is distributed to each port and the port drawing the most power will receive more watts than the one that is not.
- Color option of black anodized housing with black receptacles or clear anodized housing with white receptacles.

Specification Tips

- **Configuration and quantity of power and data ports cannot be modified in the field.**
- **For use with 120 volt 60 hertz power source only.**
- **For use with:**
 - Planes or Planes LT Model Height Adjustable Tables
 - Planes or Planes LT Model Height Adjustable Benching
 - Upside+ or Upside Model Height Adjustable Tables
- Separately specify attachment hardware for desired application.
- Designed to be used with cable chain.
- Requires field installation.
- Application may require approval of local authority having jurisdiction (AHJ); ensure compliance before placing orders and installation.

To Order, Specify:

- 1) Product number.
(No finish specification required.)

Top Depth	Top Width	Cord Length	Housing Color	Port Color	Port	Port Configuration	Number	Price
3"(76mm)	6.5"(165mm)	10'(3048mm)-12'(3658mm)	Black Anodized	Black	4	2 Power Receptacles, 1 Smart USB-A+C Charging, 1 Data Port	EUDI-SLOB-2110	\$1206.96
					4	2 Power Receptacles, 2 Smart USB-A+C Charging	EUDI-SLOB-2200	1312.78
					4	3 Power Receptacles, 1 Data Port	EUDI-SLOB-3010	1101.14
					4	3 Power Receptacles, 1 Smart USB-A+C Charging	EUDI-SLOB-3100	1206.96
					4	4 Power Receptacles	EUDI-SLOB-4000	1101.14
			Clear Anodized	White	4	2 Power Receptacles, 1 Smart USB-A+C Charging, 1 Data Port	EUDI-SLOW-2110	\$1023.55
					4	2 Power Receptacles, 2 Smart USB-A+C Charging	EUDI-SLOW-2200	1129.37
					4	3 Power Receptacles, 1 Data Port	EUDI-SLOW-3010	917.73
					4	3 Power Receptacles, 1 Smart USB-A+C Charging	EUDI-SLOW-3100	1023.55
					4	4 Power Receptacles	EUDI-SLOW-4000	917.73

Worksurface Power Modules — Enhanced Power Brackets

Above Worksurface — Adjustable

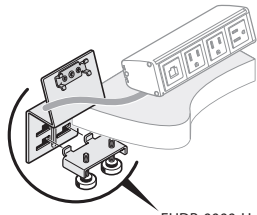

EUDB-0000-H

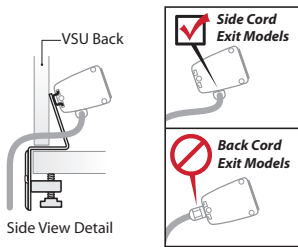

Side View Detail

EUDB-0000-H
Class YA

Features

- Includes bracket and mounting hardware.
- For use with 3, 4 or 6 port Enhanced Power Module and 2-6 port Seamless Enhanced Power Modules.
- Available in black or white.
- Mounts to back edge of 1.18"(30mm) to 2"(51mm) worktop.
- Not for use with a tack board.

Specification Tips

- Specify Enhanced Power Module separately.
- Requires field installation.
- Application may require approval of local authority having jurisdiction (AHJ); ensure compliance before placing orders and installation.

To Order, Specify:

- 1) Product number.
(No finish specification required.)

Height	Width	Length	Description	Number	Price
4"(102mm)	3.5"(89mm)	3.5"(89mm)	Black Bracket	EUDB-0000-HB	\$98.96
			White Bracket	EUDB-0000-HW	98.96

Above Worksurface — Adjustable for Knife Edge

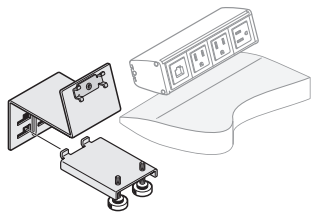

EUDB-0000-NB

EUDB-0000-N
Class YA – GSA: Open Market



Features

- Includes bracket and mounting hardware.
- For use with 3, 4 or 6 port Enhanced Power Module and 2-6 port Seamless Enhanced Power Modules.
- Available in black or white.
- Mounts to worksurface edge.

Specification Tips

- Designed to be used with 1.18"(30mm) thick surfaces with clear space below.
- Specify Enhanced Power Module separately.
- Requires field installation.
- Application may require approval of local authority having jurisdiction (AHJ); ensure compliance before placing orders and installation.
- Designed to be used with knife edge worksurfaces.

To Order, Specify:

- 1) Product number.
(No finish specification required.)

Height	Width	Length	Description	Number	Price
4"(102mm)	3.5"(89mm)	3.5"(89mm)	Black Bracket	EUDB-0000-NB	\$142.77
			White Bracket	EUDB-0000-NW	142.77

Worksurface Power Modules — Enhanced Power Brackets

Above Worksurface — Adjustable with Tackboard Offset

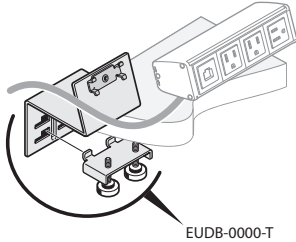

EADB-0000-T

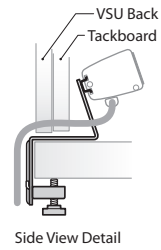

EADB-0000-T
Class YA

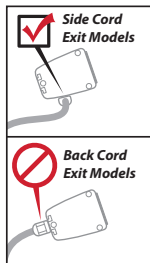

Features

- Includes bracket and mounting hardware.
- For use with 3, 4 or 6 port Enhanced Power Module and 2-6 port Seamless Enhanced Power Modules.
- Available in black or white.
- Mounts to back edge of 1.18”(30mm) to 2”(51mm) worktop when a tackboard or slat, glass, laminate or veneer tile is present.

Specification Tips

- Specify Enhanced Power Module separately.
- Requires field installation.
- Application may require approval of local authority having jurisdiction (AHJ); ensure compliance before placing orders and installation.

To Order, Specify:

- 1) Product number.
(No finish specification required.)

Height	Width	Length	Description	Number	Price
4”(102mm)	3.5”(89mm)	3.5”(89mm)	Black Bracket	EADB-0000-TB	\$98.96
			White Bracket	EADB-0000-TW	98.96

Above Worksurface — Fixed

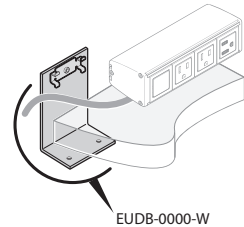

EADB-0000-W

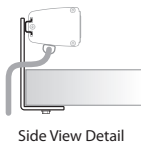

EADB-0000-W
Class YA

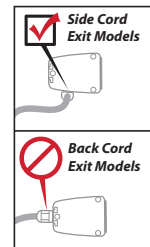

Features

- Includes bracket and mounting hardware.
- For use with 3, 4 or 6 port Enhanced Power Module and 2-6 port Seamless Enhanced Power Modules.
- Available in black or white.
- Mounts under worksurface with Enhanced Power Module above worksurface.

Specification Tips

- Designed to be used with 1.18” (30mm) thick surfaces with clear space below.
- Specify Enhanced Power Module separately.
- Requires field installation.
- Application may require approval of local authority having jurisdiction (AHJ); ensure compliance before placing orders and installation.

To Order, Specify:

- 1) Product number.
(No finish specification required.)

Height	Width	Length	Description	Number	Price
4.25”(107mm)	3”(76mm)	2”(51mm)	Black Bracket	EADB-0000-WB	\$98.96
			White Bracket	EADB-0000-WW	98.96

Worksurface Power Modules — Enhanced Power Brackets

Under Worksurface — Fixed

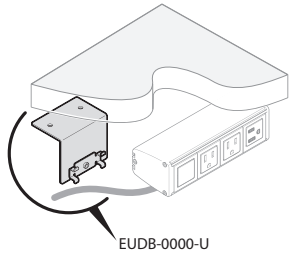

EUDB-0000-U



Side View Detail

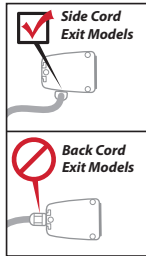

EUDB-0000-U
Class YA

Features

- Includes bracket and mounting hardware.
- For use with 3, 4 or 6 port Enhanced Power Module and 2-6 port Seamless Enhanced Power Modules.
- Available in black or white.
- Mounts under worksurface with offset to accommodate most transformer plugs.

Specification Tips

- Designed to be used with 1.18"(30mm) thick surfaces with clear space below.
- Specify Enhanced Power Module separately.
- Requires field installation.
- Application may require approval of local authority having jurisdiction (AHJ); ensure compliance before placing orders and installation.

To Order, Specify:

- 1) Product number.
(No finish specification required.)

Height	Width	Length	Description	Number	Price
2"(51mm)	33"(838mm)	2.5"(64mm)	Black Bracket	EUDB-0000-UB	\$98.96
			White Bracket	EUDB-0000-UW	98.96

For Use with X Series

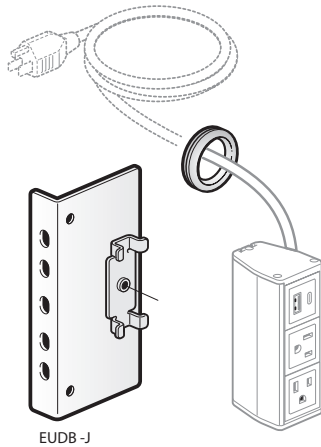

EUDB-J

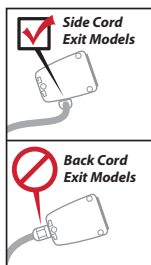

EUDB-J
Class YA

Features

- Includes bracket, grommet and mounting hardware.
- Field installed.

Specification Tips

- Bracket designed to be used with Enhanced Power Module only.
- Designed to be used in X Series open storage cavities of lockers, group lockers, cubby lockers and combination units.
- Cannot be used in drawers or personal storage towers.
- A 1.25"(32mm) diameter Greenlee punch is recommended to punch the power hole through the back of our products (lockers).
- Application may require approval of local authority having jurisdiction (AHJ); ensure compliance before placing orders and installation.

To Order, Specify:

- 1) Product number.
(No finish specification required.)

Height	Depth	Width	Trim Color	Number	Price
5"(127mm)	1.125"(29mm)	2.375"(60mm)	Black	EUDB-0000-JB	\$98.96
			White	EUDB-0000-JW	98.96

Worksurface Power Modules — Classic Power

Classic Power Module

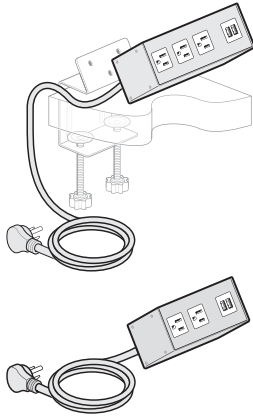

EUF1-PFOB
Class YA – GSA: Open Market

Features

- Includes power module with 3 or 4 ports configured with simplex outlets (NEMA-5-15R), USB charging port (with two USB outlets).
- Corded power module with 15 amp - 6'(1829mm) or 10'(3048mm) long cord with plug (NEMA 5-15P).
- USB Charging Port consists of two 5V USB 2.0 style A outlets, each with 10.5W (2.1Amp) charging capacity.
- Attaches to surface with separately specified mounting brackets.
- Color option of black or white front.

Specification Tips

- Not for use with tackboards.
- Configuration and quantity of power and USB ports cannot be modified in the field.
- For use with 120 volt 60 hertz power source only.
- Requires field installation.
- Application may require approval of local authority having jurisdiction (AHJ); ensure compliance before placing orders and installation.
- Separately specified:
 - Mounting Bracket

To Order, Specify:

- 1) Product number.
(No finish specification required.)

Depth	Width	Cord Length	Trim Color	Color	Port	Configuration	Number	Price
Corded								
		6'(1829mm)	Black	Black	3	2 Power Receptacles, 1 USB Charging	EUF1-PFOB-21000	\$329.83
					4	3 Power Receptacles, 1 USB Charging	EUF1-PFOB-31000	346.88
		6'(1829mm)	White	White	3	2 Power Receptacles, 1 USB Charging	EUF1-PFOW-21000	\$329.83
					4	3 Power Receptacles, 1 USB Charging	EUF1-PFOW-31000	346.88
		10'(3048mm)	Black	Black	3	2Power Receptacles, 1 USB Charging	EUF1-PJOB-21000	\$355.00
					4	3 Power Receptacles, 1 USB Charging	EUF1-PJOB-31000	372.05
		10'(3048mm)	White	White	3	2 Power Receptacles, 1 USB Charging	EUF1-PJOW-21000	\$355.00
					4	3 Power Receptacles, 1 USB Charging	EUF1-PJOW-31000	372.05

Worksurface Power Modules — Classic Power Brackets

Angled

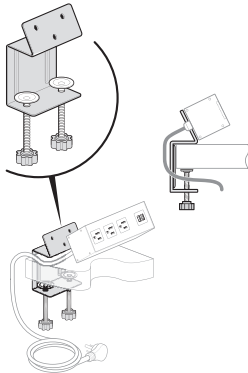

EUFB-0000-AB
Class YA

Features

- Includes one Classic Power Module mounting bracket and mounting hardware.
- Fixed Bracket mounts Classic Power Module to edge of worksurface with thumb screws for ease of relocation.

Specification Tips

- Accommodates 1.18”(30mm) and 2”(51mm) thick tops with clear space below.
- Classic Power Module applications should be reviewed by local authorities (electrical inspector) prior to ordering due to varying local codes.
- Recommended for use on panel mounted worksurface or freestanding table top.

To Order, Specify:

- 1) Product number.
(No finish specification required.)

Description	Number	Price
Black	EUFB-0000-AB	\$79.12
White	EUFB-0000-AW	79.12

Vertical

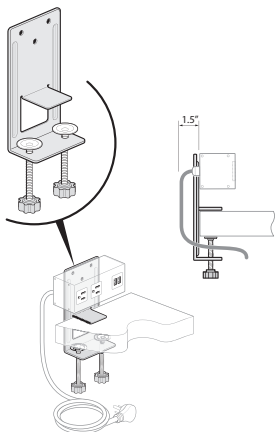

EUFB-0000-SB
Class YA

Features

- Includes one Classic Power Module mounting bracket and mounting hardware.
- Adjustable bracket mounts Classic Power Module to edge of worksurface with thumb screws for ease of relocation.

Specification Tips

- Accommodates 1.18”(30mm) and 2”(51mm) thick tops with clear space below.
- Adjustable Classic Power Module Bracket may interfere with Screen application.
- Classic Power Module applications should be reviewed by local authorities (electrical inspector) prior to ordering due to varying local codes.
- Recommended for use on freestanding table top.

To Order, Specify:

- 1) Product number.
(No finish specification required.)

Description	Number	Price
Black	EUFB-0000-SB	\$79.12
White	EUFB-0000-SW	79.12

Under Surface

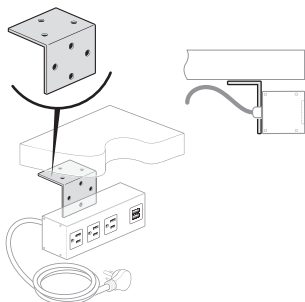

EUFB-0000-UB
Class YA

Features

- Includes one Classic Power Module mounting bracket and mounting hardware.
- Under Surface bracket mounts Classic Power Module under worksurface with mounting screws.

Specification Tips

- Under surface Classic Power Module bracket may be used on top of worksurface in restricted reach (ADA) applications. Mounting screws will deface top of worksurface.
- Classic Power Module applications should be reviewed by local authorities (electrical inspector) prior to ordering due to varying local codes.

To Order, Specify:

- 1) Product number.
(No finish specification required.)

Description	Number	Price
Black	EUFB-0000-UB	\$79.12
White	EUFB-0000-UW	79.12

Worksurface Power Modules — Flip Top

Smooth Bezel — Corded — Single-Sided

Power, Data and USB

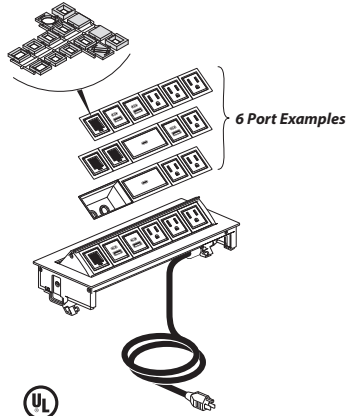

EUCI-PFOP-311010

(2) Power

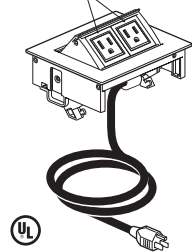

EUCI-PFOP-200000

(2) Power
(1) Smart USB-A+C
(1) Data Port

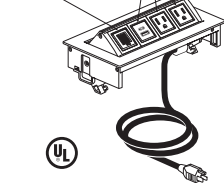

EUCI-PFOP-210010

(4) Power

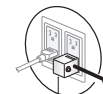
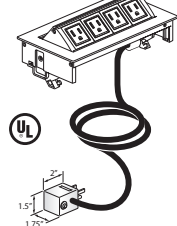

NOTE:
Always Circuit Breaker Plug when more than three power outlets specified.

EUCI-PFOP-400000

Class YA - GSA: Open Market

Features

- Includes flip top with smooth bezel module with 2, 4, or 6 ports configured with simplex outlets (NEMA 5-15R), USB charging port (USB-C 60W, Smart USB-A+C), data port(s) or cable bay, and mounting hardware.
- The Smart USB-A+C allows for the 20W to be transferred between the 2 ports. If the USB-A is being used, the full wattage is sent to the USB-A, and the same for the USB-C. If both are being used, the wattage is distributed to each port and the port drawing the most power will receive more watts than the one that is not.
- Data jack adapters accommodate most varieties of field supplied data jacks or separately specified AV cables. Occupies one port.
- Each cable bay can accept up to two pull out data/AV cables. Occupies two ports.
- Smart USB-A+C can provide fast charge for a mobile phone and tablets. Occupies one charging port.
- USB-C 60W can charge phone, tablets and some laptops. Occupies two ports.
- Smooth bezel is painted and features non mitered corners.
- Port color is either black or white based on smooth bezel color.
- Flip top unit is flush mounted with spring release cover.
- Flip top unit overall height is 2.75"(70mm) and will extend below the table top.
- Corded power module available with 15 amp - 6'(1829mm) or 10'(3048mm) long cord with plug (NEMA 5-15P).
- Ships assembled.

Specification Tips

- Designed to be used with 1.18"(30mm) and 2"(51mm) thick surfaces with clear space below.
- **Configuration and quantity of ports cannot be modified in the field.**
- **For use with 120 volt 60 hertz power source only.**
- Requires field installation.
- Specify factory cut hole or field cut hole as required.
- Specify AV cables separately.
- Cable Bay requires cables less than 0.3"(7.6mm) diameter.
- Corded flip top units with four or more receptacles utilize a circuit breaker plug that may block adjacent building receptacle outlet.
- Application may require approval of local authority having jurisdiction (AHJ); ensure compliance before placing orders and installation.

To Order, Specify:

- 1) Product number.
- 2) Finish color for Bezel/Port.
 - TR-PM1 Silver/White
 - TR-PM2 Midnight Black/Black
 - TR-PM8 Matte White/White
 - TR-PM9 Matte Grey/Black

Note: Order flip top units to match flip top unit cutout option specified for each top (A/B, F/V or J/K).

2, 4, and 6 Port Examples

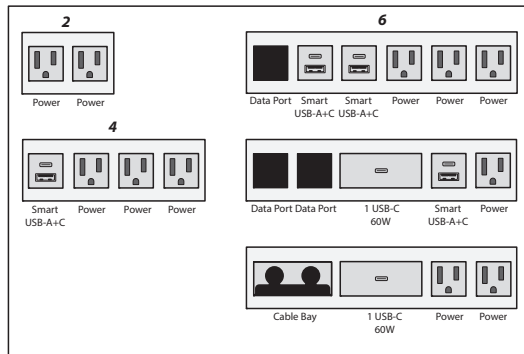

Worksurface Power Modules — Flip Top

Smooth Bezel — Corded — Single-Sided

Bezel Depth	Bezel Width	Cord Length	Port	Configuration	Cutout		Price
					Options	Number	
6'(1829mm)			2	1 Receptacle, 1 Data Port	A, B	EUC1-PFOP-100010	\$ 756.79
				1 Receptacle, 1 Smart USB-A+C Charging	A, B	EUC1-PFOP-101000	867.56
				2 Receptacles	A, B	EUC1-PFOP-200000	756.79
6'(1829mm)			4	1 Receptacle, 2 Smart USB-A+C Charging, 1 Data Port	F, V	EUC1-PFOP-111010	\$1009.09
				1 Receptacle, 1 Smart USB-A+C Charging, 1 Cable Bay	F, V	EUC1-PFOP-101001	898.32
				1 Receptacle, 1 USB-C 60W Charging, 1 Data Port	F, V	EUC1-PFOP-100110	1171.95
				2 Receptacles, 1 Cable Bay	F, V	EUC1-PFOP-200001	787.55
				2 Receptacles, 1 USB-C 60W Charging	F, V	EUC1-PFOP-200100	1171.95
				2 Receptacles, 1 Smart USB-A+C Charging, 1 Data Port	F, V	EUC1-PFOP-201010	898.32
				2 Receptacles, 2 Data Ports	F, V	EUC1-PFOP-200020	787.55
				2 Receptacles, 2 Smart USB-A+C Charging	F, V	EUC1-PFOP-202000	1009.09
				3 Receptacles, 1 Data Port	F, V	EUC1-PFOP-300010	787.55
				3 Receptacles, 1 Smart USB-A+C Charging	F, V	EUC1-PFOP-301000	898.32
				4 Receptacles	F, V	EUC1-PFOP-400000	787.55
				6'(1829mm)			6
1 Receptacle, 1 USB-C 60W Charging, 2 Data Ports	J, K	EUC1-PFOP-110120	1298.09				
1 Receptacle, 1 Smart USB-A+C Charging, 2 Data Ports, 1 Cable Bay	J, K	EUC1-PFOP-101021	913.69				
1 Receptacle, 1 USB-C 60W Charging, 1 Data Port, 1 Cable Bay	J, K	EUC1-PFOP-100111	1187.32				
2 Receptacles, 2 Smart USB-A+C Charging, 1 Cable Bay	J, K	EUC1-PFOP-211001	1024.46				
2 Receptacles, 2 Smart USB-A+C Charging, 2 Data Ports	J, K	EUC1-PFOP-211020	1024.46				
2 Receptacles, 1 Smart USB-A+C Charging, 3 Data Ports	J, K	EUC1-PFOP-201030	913.69				
2 Receptacles, 1 USB-C 60W Charging, 1 Cable Bay	J, K	EUC1-PFOP-200101	1187.32				
2 Receptacles, 1 USB-C 60W Charging, 2 Data Ports	J, K	EUC1-PFOP-200120	1187.32				
2 Receptacles, 2 Data Ports, 1 Cable Bay	J, K	EUC1-PFOP-200021	802.92				
2 Receptacles, 4 Data Ports	J, K	EUC1-PFOP-200040	802.92				
3 Receptacles, 1 Data Port, 1 Cable Bay	J, K	EUC1-PFOP-300011	802.92				
3 Receptacles, 2 Smart USB-A+C Charging, 1 Data Port	J, K	EUC1-PFOP-311010	1024.46				
3 Receptacles, 1 Smart USB-A+C Charging, 1 Cable Bay	J, K	EUC1-PFOP-301001	913.69				
3 Receptacles, 1 Smart USB-A+C Charging, 2 Data Ports	J, K	EUC1-PFOP-301020	913.69				
3 Receptacles, 1 USB-C 60W Charging, 1 Data Port	J, K	EUC1-PFOP-300110	1187.32				
3 Receptacles, 3 Data Ports	J, K	EUC1-PFOP-300030	802.92				
4 Receptacles, 1 Cable Bay	J, K	EUC1-PFOP-400001	802.92				
4 Receptacles, 1 Smart USB-A+C Charging, 1 Data Port	J, K	EUC1-PFOP-401010	913.69				
4 Receptacles, 1 USB-C 60W Charging	J, K	EUC1-PFOP-400100	1187.32				
4 Receptacles, 2 Data Ports	J, K	EUC1-PFOP-400020	802.92				
4 Receptacles, 2 Smart USB-A+C Charging	J, K	EUC1-PFOP-402000	1024.46				
5 Receptacles, 1 Data Port	J, K	EUC1-PFOP-500010	802.92				
5 Receptacles, 1 Smart USB-A+C Charging	J, K	EUC1-PFOP-501000	913.69				
6 Receptacles	J, K	EUC1-PFOP-600000	802.92				

Worksurface Power Modules — Flip Top

Smooth Bezel — Corded — Single-Sided

Bezel Depth	Bezel Width	Cord Length	Port	Configuration	Cutout Code	Options	Number	Price
		10'(3048mm)	2	1 Receptacle, 1 Data Port	A, B		EUC1-PJ0P-100010	\$ 832.21
				1 Receptacle, 1 Smart USB-A+C Charging	A, B		EUC1-PJ0P-101000	942.98
				2 Receptacles	A, B		EUC1-PJ0P-200000	832.21
			4	1 Receptacle, 2 Smart USB-A+C Charging, 1 Data Port	F, V		EUC1-PJ0P-111010	\$1084.51
				1 Receptacle, 1 Smart USB-A+C Charging, 1 Cable Bay	F, V		EUC1-PJ0P-101001	973.74
				1 Receptacle, 1 USB-C 60W Charging, 1 Data Port	F, V		EUC1-PJ0P-100110	1247.37
				2 Receptacles, 1 Cable Bay	F, V		EUC1-PJ0P-200001	862.97
				2 Receptacles, 1 Smart USB-A+C Charging, 1 Data Port	F, V		EUC1-PJ0P-201010	973.74
				2 Receptacles, 1 USB-C 60W Charging	F, V		EUC1-PJ0P-200100	1247.37
				2 Receptacles, 2 Data Ports	F, V		EUC1-PJ0P-200020	862.97
				2 Receptacles, 2 Smart USB-A+C Charging	F, V		EUC1-PJ0P-202000	1084.51
				3 Receptacles, 1 Data Port	F, V		EUC1-PJ0P-300010	862.97
				3 Receptacles, 1 Smart USB-A+C Charging	F, V		EUC1-PJ0P-301000	973.74
				4 Receptacles	F, V		EUC1-PJ0P-400000	862.97
			6	1 Receptacle, 2 Smart USB-A+C Charging, 1 Data Port, 1 Cable Bay	J, K		EUC1-PJ0P-111011	\$1099.88
				1 Receptacle, 1 Smart USB-A+C Charging, 1 USB-C 60W Charging, 2 Data Ports	J, K		EUC1-PJ0P-110120	1373.51
				1 Receptacle, 1 Smart USB-A+C Charging, 2 Data Ports, 1 Cable Bay	J, K		EUC1-PJ0P-101021	989.11
				1 Receptacle, 1 USB-C 60W Charging, 1 Data Port, 1 Cable Bay	J, K		EUC1-PJ0P-100111	1262.74
				2 Receptacles, 2 Smart USB-A+C Charging, 1 Cable Bay	J, K		EUC1-PJ0P-211001	1099.88
				2 Receptacles, 2 Smart USB-A+C Charging, 2 Data Ports	J, K		EUC1-PJ0P-211020	1099.88
				2 Receptacles, 1 Smart USB-A+C Charging, 3 Data Ports	J, K		EUC1-PJ0P-201030	989.11
				2 Receptacles, 1 USB-C 60W Charging, 1 Cable Bay	J, K		EUC1-PJ0P-200101	1262.74
				2 Receptacles, 1 USB-C 60W Charging, 2 Data Ports	J, K		EUC1-PJ0P-200120	1262.74
				2 Receptacles, 2 Data Ports, 1 Cable Bay	J, K		EUC1-PJ0P-200021	878.34
				2 Receptacles, 4 Data Ports	J, K		EUC1-PJ0P-200040	878.34
				3 Receptacles, 1 Data Port, 1 Cable Bay	J, K		EUC1-PJ0P-300011	878.34
				3 Receptacles, 2 Smart USB-A+C Charging, 1 Data Port	J, K		EUC1-PJ0P-311010	1099.88
				3 Receptacles, 1 Smart USB-A+C Charging, 1 Cable Bay	J, K		EUC1-PJ0P-301001	989.11
				3 Receptacles, 1 Smart USB-A+C Charging, 2 Data Ports	J, K		EUC1-PJ0P-301020	989.11
				3 Receptacles, 1 USB-C 60W Charging, 1 Data Port	J, K		EUC1-PJ0P-300110	1262.74
				3 Receptacles, 3 Data Ports	J, K		EUC1-PJ0P-300030	878.34
				4 Receptacles, 1 Cable Bay	J, K		EUC1-PJ0P-400001	878.34
				4 Receptacles, 1 Smart USB-A+C Charging, 1 Data Port	J, K		EUC1-PJ0P-401010	989.11
				4 Receptacles, 1 USB-C 60W Charging	J, K		EUC1-PJ0P-400100	1262.74
				4 Receptacles, 2 Data Ports	J, K		EUC1-PJ0P-400020	878.34
				4 Receptacles, 2 Smart USB-A+C Charging	J, K		EUC1-PJ0P-402000	1099.88
				5 Receptacles, 1 Data Port	J, K		EUC1-PJ0P-500010	878.34
				5 Receptacles, 1 Smart USB-A+C Charging	J, K		EUC1-PJ0P-501000	989.11
				6 Receptacles	J, K		EUC1-PJ0P-600000	878.34

Worksurface Power Modules — Flip Top

Smooth Bezel — Corded — Double-Sided

Power, Data and USB

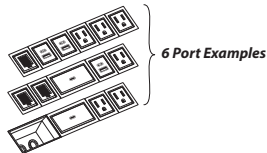
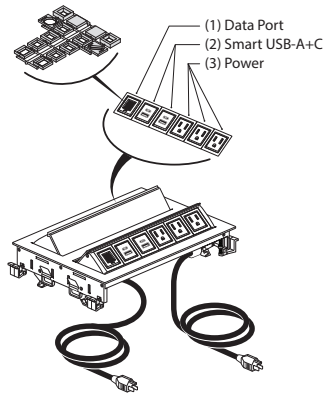

EUC2-PFOP-311010

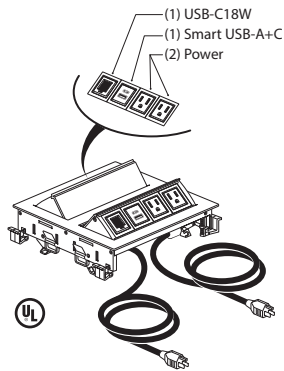

EUC2-PFOP-210010

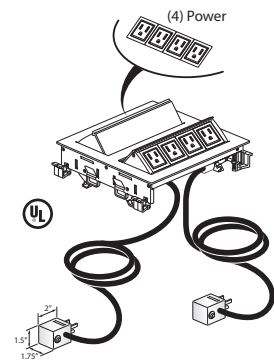

NOTE:
Always Circuit Breaker Plug when more than three power outlets specified.

EUC2-PFOP-400000

Class YA - GSA: Open Market

Features

- Includes double flip top with smooth bezel module with 2, 4, or 6 ports configured with simplex outlets (NEMA 5-15R), USB charging port (USB-C 60W, Smart USB-A+C), data port(s) or cable bay, and mounting hardware.
- The Smart USB-A+C allows for the 20W to be transferred between the 2 ports. If the USB-A is being used, the full wattage is sent to the USB-A, and the same for the USB-C. If both are being used, the wattage is distributed to each port and the port drawing the most power will receive more watts than the one that is not.
- Data jack adapters accommodate most varieties of field supplied data jacks or separately specified AV cables. Occupies one port.
- Each cable bay can accept up to two pull out data/AV cables. Occupies two ports.
- Smart USB-A+C can provide fast charge for a mobile phone and tablets. Occupies one charging port.
- USB-C 60W can charge phone, tablets and some laptops. Occupies two ports.
- Smooth bezel is painted and features non mitered corners.
- Port color is either black or white based on smooth bezel color.
- Flip top unit is flush mounted with spring release cover.
- Flip top unit overall height is 2.75"(70mm) and will extend below the table top.
- Corded power module available with two 15 amp - 6'(1829mm) or 10'(3048mm) long cord with plug (NEMA 5-15P).
- Ships assembled.

Specification Tips

- Designed to be used with 1.18"(30mm) and 2"(51mm) thick surfaces with clear space below.
- **Configuration and quantity of ports cannot be modified in the field.**
- **For use with 120 volt 60 hertz power source only.**
- Requires field installation.
- Specify factory cut hole or field cut hole as required.
- Specify AV cables separately.
- Cable Bay requires cables less than 0.3"(8mm) diameter.
- Corded flip top units with four receptacles utilize a circuit breaker plug that may block adjacent building receptacle outlet.
- Application may require approval of local authority having jurisdiction (AHJ); ensure compliance before placing orders and installation.

Notes: Two cord feeds are provided from the double-sided flip top unit.

To Order, Specify:

- 1) Product number.
- 2) Finish color for Bezel/Port.

TR-PM1	Silver/White
TR-PM2	Midnight Black/Black
TR-PM8	Matte White/White
TR-PM9	Matte Grey/Black

Note: Order flip top units to match flip top unit cutout option specified for each top (M/P or Q/T).

Worksurface Power Modules — Flip Top

Smooth Bezel — Corded — Double-Sided

Bezel Depth	Bezel Width	Cord Length	Port	Configuration	Cutout Code	Options	Number	Price				
6	1829mm		4	1 Receptacle, 2 Smart USB-A+C Charging, 1 Data Port	M, P		EUC2-PFOP-111010	\$ 1821.84				
				1 Receptacle, 1 Smart USB-A+C Charging, 1 Cable Bay	M, P		EUC2-PFOP-101001	1711.07				
				1 Receptacle, 1 USB-C 60W Charging, 1 Data Port	M, P		EUC2-PFOP-100110	1984.70				
				2 Receptacles, 1 USB-C 60W Charging	M, P		EUC2-PFOP-200100	1984.70				
				2 Receptacles, 1 Cable Bay	M, P		EUC2-PFOP-200001	1600.30				
				2 Receptacles, 1 Smart USB-A+C Charging, 1 Data Port	M, P		EUC2-PFOP-201010	1711.07				
				2 Receptacles, 2 Data Ports	M, P		EUC2-PFOP-200020	1600.30				
				2 Receptacles, 2 Smart USB-A+C Charging	M, P		EUC2-PFOP-202000	1821.84				
				3 Receptacles, 1 Data Port	M, P		EUC2-PFOP-300010	1600.30				
				3 Receptacles, 1 Smart USB-A+C Charging	M, P		EUC2-PFOP-301000	1711.07				
				4 Receptacles	M, P		EUC2-PFOP-400000	1600.30				
				6			6	1 Receptacle, 2 Smart USB-A+C Charging, 1 Data Port, 1 Cable Bay	Q, T		EUC2-PFOP-111011	\$ 1883.32
								1 Receptacle, 1 USB-C 60W Charging, 2 Data Ports	Q, T		EUC2-PFOP-110120	2156.95
								1 Receptacle, 1 Smart USB-A+C Charging, 2 Data Ports, 1 Cable Bay	Q, T		EUC2-PFOP-101021	1772.55
1 Receptacle, 1 USB-C 60W Charging, 1 Data Port, 1 Cable Bay	Q, T		EUC2-PFOP-100111					2046.18				
2 Receptacles, 2 Smart USB-A+C Charging, 1 Cable Bay	Q, T		EUC2-PFOP-211001					1883.32				
2 Receptacles, 2 Smart USB-A+C Charging, 2 Data Ports	Q, T		EUC2-PFOP-211020					1883.32				
2 Receptacles, 1 Smart USB-A+C Charging, 3 Data Ports	Q, T		EUC2-PFOP-201030					1772.55				
2 Receptacles, 1 USB-C 60W Charging, 1 Cable Bay	Q, T		EUC2-PFOP-200101					2046.18				
2 Receptacles, 1 USB-C 60W Charging, 2 Data Ports	Q, T		EUC2-PFOP-200120					2046.18				
2 Receptacles, 2 Data Ports, 1 Cable Bay	Q, T		EUC2-PFOP-200021					1661.78				
2 Receptacles, 4 Data Ports	Q, T		EUC2-PFOP-200040					1661.78				
3 Receptacles, 1 Data Port, 1 Cable Bay	Q, T		EUC2-PFOP-300011					1661.78				
3 Receptacles, 2 Smart USB-A+C Charging, 1 Data Port	Q, T		EUC2-PFOP-311010					1883.32				
3 Receptacles, 1 Smart USB-A+C Charging, 1 Cable Bay	Q, T		EUC2-PFOP-301001					1772.55				
3 Receptacles, 1 Smart USB-A+C Charging, 2 Data Ports	Q, T		EUC2-PFOP-301020					1772.55				
3 Receptacles, 1 USB-C 60W Charging, 1 Data Port	Q, T		EUC2-PFOP-300110					2046.18				
3 Receptacles, 3 Data Ports	Q, T		EUC2-PFOP-300030					1661.78				
4 Receptacles, 1 Cable Bay	Q, T		EUC2-PFOP-400001					1661.78				
4 Receptacles, 1 Smart USB-A+C Charging, 1 Data Port	Q, T		EUC2-PFOP-401010					1772.55				
4 Receptacles, 1 USB-C 60W Charging	Q, T		EUC2-PFOP-400100					2046.18				
4 Receptacles, 2 Data Ports	Q, T		EUC2-PFOP-400020					1661.78				
4 Receptacles, 2 Smart USB-A+C Charging	Q, T		EUC2-PFOP-402000					1883.32				
5 Receptacles, 1 Data Port	Q, T		EUC2-PFOP-500010	1661.78								
5 Receptacles, 1 Smart USB-A+C Charging	Q, T		EUC2-PFOP-501000	1772.55								
6 Receptacles	Q, T		EUC2-PFOP-600000	1661.78								

Worksurface Power Modules — Flip Top

Smooth Bezel — Corded — Double-Sided

Bezel Depth	Bezel Width	Cord Length	Port	Configuration	Cutout Code Options	Number	Price				
10'(3048mm)			4	1 Receptacle, 2 Smart USB-A+C Charging, 1 Data Port	M, P	EUC2-PJ0P-111010	\$ 1897.26				
				1 Receptacle, 1 Smart USB-A+C Charging, 1 Cable Bay	M, P	EUC2-PJ0P-101001	1786.49				
				1 Receptacle, 1 USB-C 60W Charging, 1 Data Port	M, P	EUC2-PJ0P-100110	2060.12				
				2 Receptacles, 1 USB-C 60W Charging	M, P	EUC2-PJ0P-200100	2060.12				
				2 Receptacles, 1 Cable Bay	M, P	EUC2-PJ0P-200001	1675.72				
				2 Receptacles, 1 Smart USB-A+C Charging, 1 Data Port	M, P	EUC2-PJ0P-201010	1786.49				
				2 Receptacles, 2 Data Ports	M, P	EUC2-PJ0P-200020	1675.72				
				2 Receptacles, 2 Smart USB-A+C Charging	M, P	EUC2-PJ0P-202000	1897.26				
				3 Receptacles, 1 Data Port	M, P	EUC2-PJ0P-300010	1675.72				
				3 Receptacles, 1 Smart USB-A+C Charging	M, P	EUC2-PJ0P-301000	1786.49				
				4 Receptacles	M, P	EUC2-PJ0P-400000	1675.72				
				6			6	1 Receptacle, 2 Smart USB-A+C Charging, 1 Data Port, 1 Cable Bay	Q, T	EUC2-PJ0P-111011	\$ 1958.74
								1 Receptacle, 1 USB-C 60W Charging, 2 Data Ports	Q, T	EUC2-PJ0P-110120	2232.37
								1 Receptacle, 1 Smart USB-A+C Charging, 2 Data Ports, 1 Cable Bay	Q, T	EUC2-PJ0P-101021	1847.97
1 Receptacle, 1 USB-C 60W Charging, 1 Data Port, 1 Cable Bay	Q, T	EUC2-PJ0P-100111	2121.60								
2 Receptacles, 2 Smart USB-A+C Charging, 1 Cable Bay	Q, T	EUC2-PJ0P-211001	1958.74								
2 Receptacles, 2 Smart USB-A+C Charging, 2 Data Ports	Q, T	EUC2-PJ0P-211020	1958.74								
2 Receptacles, 1 Smart USB-A+C Charging, 3 Data Ports	Q, T	EUC2-PJ0P-201030	1847.97								
2 Receptacles, 1 USB-C 60W Charging, 1 Cable Bay	Q, T	EUC2-PJ0P-200101	2121.60								
2 Receptacles, 1 USB-C 60W Charging, 2 Data Ports	Q, T	EUC2-PJ0P-200120	2121.60								
2 Receptacles, 2 Data Ports, 1 Cable Bay	Q, T	EUC2-PJ0P-200021	1737.20								
2 Receptacles, 4 Data Ports	Q, T	EUC2-PJ0P-200040	1737.20								
3 Receptacles, 1 Data Port, 1 Cable Bay	Q, T	EUC2-PJ0P-300011	1737.20								
3 Receptacles, 2 Smart USB-A+C Charging, 1 Data Port	Q, T	EUC2-PJ0P-311010	1958.74								
3 Receptacles, 1 Smart USB-A+C Charging, 1 Cable Bay	Q, T	EUC2-PJ0P-301001	1847.97								
3 Receptacles, 1 Smart USB-A+C Charging, 2 Data Ports	Q, T	EUC2-PJ0P-301020	1847.97								
3 Receptacles, 1 USB-C 60W Charging, 1 Data Port	Q, T	EUC2-PJ0P-300110	2121.60								
3 Receptacles, 3 Data Ports	Q, T	EUC2-PJ0P-300030	1737.20								
4 Receptacles, 1 Cable Bay	Q, T	EUC2-PJ0P-400001	1737.20								
4 Receptacles, 1 Smart USB-A+C Charging, 1 Data Port	Q, T	EUC2-PJ0P-401010	1847.97								
4 Receptacles, 1 USB-C 60W Charging	Q, T	EUC2-PJ0P-400100	2121.60								
4 Receptacles, 2 Data Ports	Q, T	EUC2-PJ0P-400020	1737.20								
4 Receptacles, 2 Smart USB-A+C Charging	Q, T	EUC2-PJ0P-402000	1958.74								
5 Receptacles, 1 Data Port	Q, T	EUC2-PJ0P-500010	1737.20								
5 Receptacles, 1 Smart USB-A+C Charging	Q, T	EUC2-PJ0P-501000	1847.97								
6 Receptacles	Q, T	EUC2-PJ0P-600000	1737.20								

Worksurface Power Modules — Flip Top

Smooth Bezel — Hardwire — Single-Sided

Power, Data and USB

Features

- Includes flip top with smooth bezel module with 2, 4, or 6 ports configured with simplex outlets (NEMA 5-15R), USB charging port (USB-A, USB-C 60W, Smart USB-A+C), data port(s) or cable bay, and mounting hardware.
- The Smart USB-A+C allows for the 20W to be transferred between the 2 ports. If the USB-A is being used, the full wattage is sent to the USB-A, and the same for the USB-C. If both are being used, the wattage is distributed to each port and the port drawing the most power will receive more watts than the one that is not.
- Data jack adapters accommodate most varieties of field supplied data jacks or separately specified AV cables. Occupies one port.
- Each cable bay can accept up to two pull out data/AV cables. Occupies two ports.
- Smart USB-A+C can provide fast charge for a mobile phone and tablets. Occupies one charging port.
- USB-C 60W can charge phone, tablets and some laptops. Occupies two ports.
- Smooth bezel is painted and features non mitered corners.
- Port color is either black or white based on smooth bezel color.
- Flip top unit is flush mounted with spring release cover.
- Flip top unit overall height is 2.75" (70mm) and will extend below the table top.
- Hardwired power module with 6' (1829mm) or 10' (3048mm) long flexible metal conduit feed, 0.5" (13mm) conduit fitting and wires for hardwire connection.
- Ships assembled.

Specification Tips

- Designed to be used with 1.18" (30mm) and 2" (51mm) thick surfaces with clear space below.
- **Configuration and quantity of ports cannot be modified in the field.**
- **For use with 120 volt 60 hertz power source only.**
- Requires field installation.
- Specify factory cut hole or field cut hole as required.
- Specify AV cables separately.
- Cable Bay requires cables less than 0.3" (8mm) diameter.
- Application may require approval of local authority having jurisdiction (AHJ); ensure compliance before placing orders and installation.

To Order, Specify:

- 1) Product number.
- 2) Finish color for Bezel/Port.

TR-PM1	Silver/White
TR-PM2	Midnight Black/Black
TR-PM8	Matte White/White
TR-PM9	Matte Grey/Black

Note: Order flip top units to match flip top unit cutout option specified for each top (A/B, F/V or J/K).

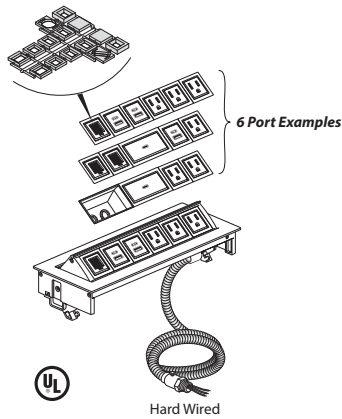

EUC1-HFOP-311010

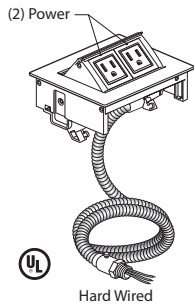

EUC1-HFOP-200000

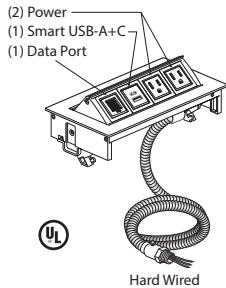

EUC1-HFOP-210010

Class YA – GSA: Open Market

Worksurface Power Modules — Flip Top

Smooth Bezel — Hardwire — Single-Sided

Bezel Depth	Bezel Width	Cord Length	Port	Configuration	Cutout Code	Options	Number	Price
		6'(1829mm)	2	1 Receptacle, 1 Data Port	A, B		EUC1-HFOP-100010	\$ 880.19
				1 Receptacle, 1 Smart USB-A+C Charging	A, B		EUC1-HFOP-101000	990.96
				2 Receptacles	A, B		EUC1-HFOP-200000	880.19
			4	1 Receptacle, 2 Smart USB-A+C Charging, 1 Data Port	F, V		EUC1-HFOP-111010	\$ 1132.49
				1 Receptacle, 1 Smart USB-A+C Charging, 1 Cable Bay	F, V		EUC1-HFOP-101001	1021.72
				1 Receptacle, 1 USB-C 60W Charging, 1 Data Port	F, V		EUC1-HFOP-100110	1295.35
				2 Receptacles, 1 Cable Bay	F, V		EUC1-HFOP-200001	910.95
				2 Receptacles, 1 USB-C 60W Charging	F, V		EUC1-HFOP-200100	1295.35
				2 Receptacles, 1 Smart USB-A+C Charging, 1 Data Port	F, V		EUC1-HFOP-201010	1021.72
				2 Receptacles, 2 Data Ports	F, V		EUC1-HFOP-200020	910.95
				2 Receptacles, 2 Smart USB-A+C Charging	F, V		EUC1-HFOP-202000	1132.49
				3 Receptacles, 1 Data Port	F, V		EUC1-HFOP-300010	910.95
				3 Receptacles, 1 Smart USB-A+C Charging	F, V		EUC1-HFOP-301000	1021.72
				4 Receptacles	F, V		EUC1-HFOP-400000	910.95
			6	1 Receptacle, 2 Smart USB-A+C Charging, 1 Data Port, 1 Cable Bay	J, K		EUC1-HFOP-111011	\$ 1147.86
				1 Receptacle, 1 USB-C 60W Charging, 2 Data Ports	J, K		EUC1-HFOP-110120	1421.49
				1 Receptacle, 1 Smart USB-A+C Charging, 2 Data Ports, 1 Cable Bay	J, K		EUC1-HFOP-101021	1037.09
				1 Receptacle, 1 USB-C 60W Charging, 1 Data Port, 1 Cable Bay	J, K		EUC1-HFOP-100111	1310.72
				2 Receptacles, 2 Smart USB-A+C Charging, 1 Cable Bay	J, K		EUC1-HFOP-211001	1147.86
				2 Receptacles, 2 Smart USB-A+C Charging, 2 Data Ports	J, K		EUC1-HFOP-211020	1147.86
				2 Receptacles, 1 Smart USB-A+C Charging, 3 Data Ports	J, K		EUC1-HFOP-201030	1037.09
				2 Receptacles, 1 USB-C 60W Charging, 1 Cable Bay	J, K		EUC1-HFOP-200101	1310.72
				2 Receptacles, 1 USB-C 60W Charging, 2 Data Ports	J, K		EUC1-HFOP-200120	1310.72
				2 Receptacles, 2 Data Ports, 1 Cable Bay	J, K		EUC1-HFOP-200021	926.32
				2 Receptacles, 4 Data Ports	J, K		EUC1-HFOP-200040	926.32
				3 Receptacles, 1 Data Port, 1 Cable Bay	J, K		EUC1-HFOP-300011	926.32
				3 Receptacles, 2 Smart USB-A+C Charging, 1 Data Port	J, K		EUC1-HFOP-311010	1147.86
				3 Receptacles, 1 Smart USB-A+C Charging, 1 Cable Bay	J, K		EUC1-HFOP-301001	1037.09
				3 Receptacles, 1 Smart USB-A+C Charging, 2 Data Ports	J, K		EUC1-HFOP-301020	1037.09
				3 Receptacles, 1 USB-C 60W Charging, 1 Data Port	J, K		EUC1-HFOP-300110	1310.72
				3 Receptacles, 3 Data Ports	J, K		EUC1-HFOP-300030	926.32
				4 Receptacles, 2 Smart USB-A+C Charging	J, K		EUC1-HFOP-402000	1147.86
				4 Receptacles, 1 Cable Bay	J, K		EUC1-HFOP-400001	926.32
				4 Receptacles, 1 Smart USB-A+C Charging, 1 Data Port	J, K		EUC1-HFOP-401010	1037.09
				4 Receptacles, 1 USB-C 60W Charging	J, K		EUC1-HFOP-400100	1310.72
				4 Receptacles, 2 Data Ports	J, K		EUC1-HFOP-400020	926.32
				5 Receptacles, 1 Data Port	J, K		EUC1-HFOP-500010	926.32
				5 Receptacles, 1 Smart USB-A+C Charging	J, K		EUC1-HFOP-501000	1037.09
				6 Receptacles	J, K		EUC1-HFOP-600000	926.32

Worksurface Power Modules — Flip Top

Smooth Bezel — Hardwire — Single-Sided

Bezel Depth	Bezel Width	Cord Length	Port	Configuration	Cutout Code Options	Number	Price
		10'(3048mm)	2	1 Receptacle, 1 Data Port	A, B	EUC1-HJOP-100010	\$ 955.61
				1 Receptacle, 1 Smart USB-A+C Charging	A, B	EUC1-HJOP-101000	1066.38
				2 Receptacles	A, B	EUC1-HJOP-200000	955.61
			4	1 Receptacle, 2 Smart USB-A+C Charging, 1 Data Port	F, V	EUC1-HJOP-111010	\$ 1207.91
				1 Receptacle, 1 Smart USB-A+C Charging, 1 Cable Bay	F, V	EUC1-HJOP-101001	1097.14
				1 Receptacle, 1 USB-C 60W Charging, 1 Data Port	F, V	EUC1-HJOP-100110	1370.77
				2 Receptacles, 1 Cable Bay	F, V	EUC1-HJOP-200001	986.37
				2 Receptacles, 1 Smart USB-A+C Charging, 1 Data Port	F, V	EUC1-HJOP-201010	1097.14
				2 Receptacles, 1 USB-C 60W Charging	F, V	EUC1-HJOP-200100	1370.77
				2 Receptacles, 2 Data Ports	F, V	EUC1-HJOP-200020	986.37
				2 Receptacles, 2 Smart USB-A+C Charging	F, V	EUC1-HJOP-202000	1207.91
				3 Receptacles, 1 Data Port	F, V	EUC1-HJOP-300010	986.37
				3 Receptacles, 1 Smart USB-A+C Charging	F, V	EUC1-HJOP-301000	1097.14
				4 Receptacles	F, V	EUC1-HJOP-400000	986.37
			6	1 Receptacle, 2 Smart USB-A+C Charging, 1 Data Port, 1 Cable Bay	J, K	EUC1-HJOP-111011	\$ 1223.28
				1 Receptacle, 1 USB-C 60W Charging, 2 Data Ports	J, K	EUC1-HJOP-110120	1496.91
				1 Receptacle, 1 Smart USB-A+C Charging, 2 Data Ports, 1 Cable Bay	J, K	EUC1-HJOP-101021	1112.51
				1 Receptacle, 1 USB-C 60W Charging, 1 Data Port, 1 Cable Bay	J, K	EUC1-HJOP-100111	1386.14
				2 Receptacles, 2 Smart USB-A+C Charging, 1 Cable Bay	J, K	EUC1-HJOP-211001	1223.28
				2 Receptacles, 2 Smart USB-A+C Charging, 2 Data Ports	J, K	EUC1-HJOP-211020	1223.28
				2 Receptacles, 1 Smart USB-A+C Charging, 3 Data Ports	J, K	EUC1-HJOP-201030	1112.51
				2 Receptacles, 1 USB-C 60W Charging, 1 Cable Bay	J, K	EUC1-HJOP-200101	1386.14
				2 Receptacles, 1 USB-C 60W Charging, 2 Data Ports	J, K	EUC1-HJOP-200120	1386.14
				2 Receptacles, 2 Data Ports, 1 Cable Bay	J, K	EUC1-HJOP-200021	1001.74
				2 Receptacles, 4 Data Ports	J, K	EUC1-HJOP-200040	1001.74
				3 Receptacles, 1 Data Port, 1 Cable Bay	J, K	EUC1-HJOP-300011	1001.74
				3 Receptacles, 2 Smart USB-A+C Charging, 1 Data Port	J, K	EUC1-HJOP-311010	1223.28
				3 Receptacles, 1 Smart USB-A+C Charging, 1 Cable Bay	J, K	EUC1-HJOP-301001	1112.51
				3 Receptacles, 1 Smart USB-A+C Charging, 2 Data Ports	J, K	EUC1-HJOP-301020	1112.51
				3 Receptacles, 1 USB-C 60W Charging, 1 Data Port	J, K	EUC1-HJOP-300110	1386.14
				3 Receptacles, 3 Data Ports	J, K	EUC1-HJOP-300030	1001.74
				4 Receptacles, 1 Cable Bay	J, K	EUC1-HJOP-400001	1001.74
				4 Receptacles, 1 Smart USB-A+C Charging, 1 Data Port	J, K	EUC1-HJOP-401010	1112.51
				4 Receptacles, 1 USB-C 60W Charging	J, K	EUC1-HJOP-400100	1386.14
				4 Receptacles, 2 Data Ports	J, K	EUC1-HJOP-400020	1001.74
				4 Receptacles, 2 Smart USB-A+C Charging	J, K	EUC1-HJOP-402000	1223.28
				5 Receptacles, 1 Data Port	J, K	EUC1-HJOP-500010	1001.74
				5 Receptacles, 1 Smart USB-A+C Charging	J, K	EUC1-HJOP-501000	1112.51
				6 Receptacles	J, K	EUC1-HJOP-600000	1001.74

Worksurface Power Modules — Flip Top

Smooth Bezel — Hardwire — Double-Sided

Power, Data and USB

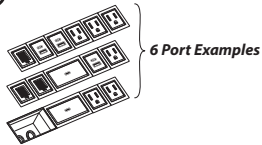
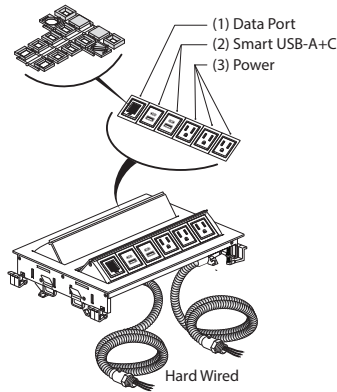

EUC2-HFOP-311010

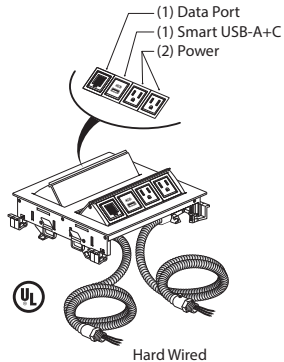

EUC2-HFOP-210010

Class YA – GSA: Open Market

Features

- Includes double flip top with smooth bezel module with 2, 4, or 6 ports configured with simplex outlets (NEMA 5-15R), USB charging port (USB-C 60W, Smart USB-A+C), data port(s) or cable bay, and mounting hardware.
- The Smart USB-A+C allows for the 20W to be transferred between the 2 ports. If the USB-A is being used, the full wattage is sent to the USB-A, and the same for the USB-C. If both are being used, the wattage is distributed to each port and the port drawing the most power will receive more watts than the one that is not.
- Data jack adapters accommodate most varieties of field supplied data jacks or separately specified AV cables. Occupies one port.
- Each cable bay can accept up to two pull out data/AV cables. Occupies two ports.
- USB-A provides two 10W charging ports. Occupies one port.
- Smart USB-A+C can provide fast charge for a mobile phone and tablets. Occupies one charging port.
- USB-C 60W can charge phone, tablets and some laptops. Occupies two ports.
- Smooth bezel is painted and features non mitered corners.
- Port color is either black or white based on smooth bezel color.
- Flip top unit is flush mounted with spring release cover.
- Flip top unit overall height is 2.75”(70mm) and will extend below the table top.
- Each flip top module within the bezel provided with two 6’(1829mm) or 10’(3048mm) long flexible metal conduit feed, 0.5”(13mm) conduit fitting and wires for hardwire connection.
- Ships assembled.

Specification Tips

- Designed to be used with 1.18”(30mm) and 2”(51mm) thick surfaces with clear space below.
- **Configuration and quantity of ports cannot be modified in the field.**
- **For use with 120 volt 60 hertz power source only.**
- Note two conduit feeds are provided from the double-sided flip top unit.
- Requires field installation.
- Specify factory cut hole or field cut hole as required.
- Specify AV cables separately.
- Cable Bay requires cables less than 0.3”(8mm) diameter.
- Application may require approval of local authority having jurisdiction (AHJ); ensure compliance before placing orders and installation.

To Order, Specify:

- 1) Product number.
- 2) Finish color for Bezel/Port.

TR-PM1	Silver/White
TR-PM2	Midnight Black/Black
TR-PM8	Matte White/White
TR-PM9	Matte Grey/Black

Note: Order flip top units to match flip top unit cutout option specified for each top (M/P or Q/V).

Worksurface Power Modules — Flip Top

Smooth Bezel — Hardwire — Double-Sided

Bezel Depth	Bezel Width	Cord Length	Port	Configuration	Cutout Code Options	Number	Price				
6	1829mm		4	1 Receptacle, 2 Smart USB-A+C Charging, 1 Data Port	M, P	EUC2-HFOP-111010	\$2068.64				
				1 Receptacle, 1 Smart USB-A+C Charging, 1 Cable Bay	M, P	EUC2-HFOP-101001	1957.87				
				1 Receptacle, 1 USB-C 60W Charging, 1 Data Port	M, P	EUC2-HFOP-100110	2231.50				
				2 Receptacles, 1 USB-C 60W Charging	M, P	EUC2-HFOP-200100	2231.50				
				2 Receptacles, 1 Cable Bay	M, P	EUC2-HFOP-200001	1847.10				
				2 Receptacles, 1 Smart USB-A+C Charging, 1 Data Port	M, P	EUC2-HFOP-201010	1957.87				
				2 Receptacles, 2 Data Ports	M, P	EUC2-HFOP-200020	1847.10				
				2 Receptacles, 2 Smart USB-A+C Charging	M, P	EUC2-HFOP-202000	2068.64				
				3 Receptacles, 1 Data Port	M, P	EUC2-HFOP-300010	1847.10				
				3 Receptacles, 1 Smart USB-A+C Charging	M, P	EUC2-HFOP-301000	1957.87				
				4 Receptacles	M, P	EUC2-HFOP-400000	1847.10				
				6			6	1 Receptacle, 2 Smart USB-A+C Charging, 1 Data Port, 1 Cable Bay	Q, V	EUC2-HFOP-111011	\$ 2130.12
								1 Receptacle, 1 USB-C 60W Charging, 2 Data Ports	Q, V	EUC2-HFOP-110120	2403.75
1 Receptacle, 1 Smart USB-A+C Charging, 2 Data Ports, 1 Cable Bay	Q, V	EUC2-HFOP-101021	2019.35								
1 Receptacle, 1 USB-C 60W Charging, 1 Data Port, 1 Cable Bay	Q, V	EUC2-HFOP-100111	2292.98								
2 Receptacles, 2 Smart USB-A+C Charging, 1 Cable Bay	Q, V	EUC2-HFOP-211001	2130.12								
2 Receptacles, 2 Smart USB-A+C Charging, 2 Data Ports	Q, V	EUC2-HFOP-211020	2130.12								
2 Receptacles, 1 Smart USB-A+C Charging, 3 Data Ports	Q, V	EUC2-HFOP-201030	2019.35								
2 Receptacles, 1 USB-C 60W Charging, 1 Cable Bay	Q, V	EUC2-HFOP-200101	2292.98								
2 Receptacles, 1 USB-C 60W Charging, 2 Data Ports	Q, V	EUC2-HFOP-200120	2292.98								
2 Receptacles, 2 Data Ports, 1 Cable Bay	Q, V	EUC2-HFOP-200021	1908.58								
2 Receptacles, 4 Data Ports	Q, V	EUC2-HFOP-200040	1908.58								
3 Receptacles, 1 Data Port, 1 Cable Bay	Q, V	EUC2-HFOP-300011	1908.58								
3 Receptacles, 2 Smart USB-A+C Charging, 1 Data Port	Q, V	EUC2-HFOP-311010	2130.12								
3 Receptacles, 1 Smart USB-A+C Charging, 1 Cable Bay	Q, V	EUC2-HFOP-301001	2019.35								
3 Receptacles, 1 Smart USB-A+C Charging, 2 Data Ports	Q, V	EUC2-HFOP-301020	2019.35								
3 Receptacles, 1 USB-C 60W Charging, 1 Data Port	Q, V	EUC2-HFOP-300110	2292.98								
3 Receptacles, 3 Data Ports	Q, V	EUC2-HFOP-300030	1908.58								
4 Receptacles, 1 Cable Bay	Q, V	EUC2-HFOP-400001	1908.58								
4 Receptacles, 1 Smart USB-A+C Charging, 1 Data Port	Q, V	EUC2-HFOP-401010	2019.35								
4 Receptacles, 1 USB-C 60W Charging	Q, V	EUC2-HFOP-400100	2292.98								
4 Receptacles, 2 Data Ports	Q, V	EUC2-HFOP-400020	1908.58								
4 Receptacles, 2 Smart USB-A+C Charging	Q, V	EUC2-HFOP-402000	2130.12								
5 Receptacles, 1 Data Port	Q, V	EUC2-HFOP-500010	1908.58								
5 Receptacles, 1 Smart USB-A+C Charging	Q, V	EUC2-HFOP-501000	2019.35								
6 Receptacles	Q, V	EUC2-HFOP-600000	1908.58								

Worksurface Power Modules — Flip Top

Smooth Bezel — Hardwire — Double-Sided

Bezel Depth	Bezel Width	Cord Length	Port	Configuration	Cutout Code Options	Number	Price				
10'(3048mm)			4	1 Receptacle, 2 Smart USB-A+C Charging, 1 Data Port	M, P	EUC2-HJOP-111010	\$ 2144.06				
				1 Receptacle, 1 Smart USB-A+C Charging, 1 Cable Bay	M, P	EUC2-HJOP-101001	2033.29				
				1 Receptacle, 1 USB-C 60W Charging, 1 Data Port	M, P	EUC2-HJOP-100110	2306.92				
				2 Receptacles, 1 USB-C 60W Charging	M, P	EUC2-HJOP-200100	2306.92				
				2 Receptacles, 1 Cable Bay	M, P	EUC2-HJOP-200001	1922.52				
				2 Receptacles, 1 Smart USB-A+C Charging, 1 Data Port	M, P	EUC2-HJOP-201010	2033.29				
				2 Receptacles, 2 Data Ports	M, P	EUC2-HJOP-200020	1922.52				
				2 Receptacles, 2 Smart USB-A+C Charging	M, P	EUC2-HJOP-202000	2144.06				
				3 Receptacles, 1 Data Port	M, P	EUC2-HJOP-300010	1922.52				
				3 Receptacles, 1 Smart USB-A+C Charging	M, P	EUC2-HJOP-301000	2033.29				
				4 Receptacles	M, P	EUC2-HJOP-400000	1922.52				
				6			6	1 Receptacle, 2 Smart USB-A+C Charging, 1 Data Port, 1 Cable Bay	Q, V	EUC2-HJOP-111011	\$2205.54
								1 Receptacle, 1 USB-C 60W Charging, 2 Data Ports	Q, V	EUC2-HJOP-110120	2479.17
								1 Receptacle, 1 Smart USB-A+C Charging, 2 Data Ports, 1 Cable Bay	Q, V	EUC2-HJOP-101021	2094.77
1 Receptacle, 1 USB-C 60W Charging, 1 Data Port, 1 Cable Bay	Q, V	EUC2-HJOP-100111	2368.40								
2 Receptacles, 2 Smart USB-A+C Charging, 1 Cable Bay	Q, V	EUC2-HJOP-211001	2205.54								
2 Receptacles, 2 Smart USB-A+C Charging, 2 Data Ports	Q, V	EUC2-HJOP-211020	2205.54								
2 Receptacles, 1 Smart USB-A+C Charging, 3 Data Ports	Q, V	EUC2-HJOP-201030	2094.77								
2 Receptacles, 1 USB-C 60W Charging, 1 Cable Bay	Q, V	EUC2-HJOP-200101	2368.40								
2 Receptacles, 1 USB-C 60W Charging, 2 Data Ports	Q, V	EUC2-HJOP-200120	2368.40								
2 Receptacles, 2 Data Ports, 1 Cable Bay	Q, V	EUC2-HJOP-200021	1984.00								
2 Receptacles, 4 Data Ports	Q, V	EUC2-HJOP-200040	1984.00								
3 Receptacles, 1 Data Port, 1 Cable Bay	Q, V	EUC2-HJOP-300011	1984.00								
3 Receptacles, 2 Smart USB-A+C Charging, 1 Data Port	Q, V	EUC2-HJOP-311010	2205.54								
3 Receptacles, 1 Smart USB-A+C Charging, 1 Cable Bay	Q, V	EUC2-HJOP-301001	2094.77								
3 Receptacles, 1 Smart USB-A+C Charging, 2 Data Ports	Q, V	EUC2-HJOP-301020	2094.77								
3 Receptacles, 1 USB-C 60W Charging, 1 Data Port	Q, V	EUC2-HJOP-300110	2368.40								
3 Receptacles, 3 Data Ports	Q, V	EUC2-HJOP-300030	1984.00								
4 Receptacles, 1 Cable Bay	Q, V	EUC2-HJOP-400001	1984.00								
4 Receptacles, 1 Smart USB-A+C Charging, 1 Data Port	Q, V	EUC2-HJOP-401010	2094.77								
4 Receptacles, 1 USB-C 60W Charging	Q, V	EUC2-HJOP-400100	2368.40								
4 Receptacles, 2 Smart USB-A+C Charging	Q, V	EUC2-HJOP-402000	2205.54								
5 Receptacles, 1 Data Port	Q, V	EUC2-HJOP-500010	1984.00								
5 Receptacles, 1 Smart USB-A+C Charging	Q, V	EUC2-HJOP-501000	2094.77								
6 Receptacles	Q, V	EUC2-HJOP-600000	1984.00								

Worksurface Power Modules — Flip Top

Power and Data

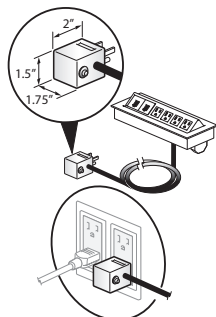
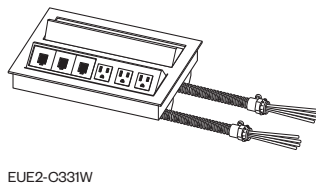
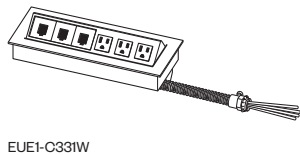
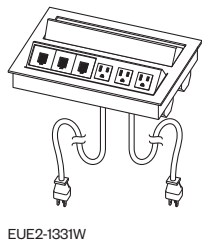
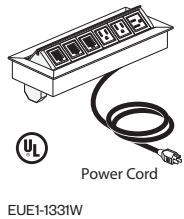
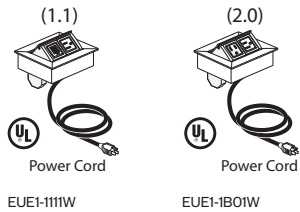

Circuit Breaker Plug Detail
Class YA

Features

- Hardwire flip top unit includes one flip top unit with power outlets and communication openings, mounting clips, 6 foot flexible metal conduit feed with wires for hardwire, multiple data jack adapters to accommodate most varieties of field supplied data jacks, also includes blank data covers.
- Corded flip top unit includes one flip top unit with power outlets and communication openings, 12 foot long – 15-amp cord with plug, mounting clips, multiple data jack adapters to accommodate most varieties of field supplied data jacks, also includes blank data covers.
- Flip top unit is flush mounted with spring release cover.
- Flip top unit overall height is 2.75”(70mm) and will extend below the table tops.
- Standard in anodized finish.
- Ships assembled.

Specification Tips

- Designed to be used with 1.18”(30mm) and 2”(51mm) thick surfaces with clear space below.
- **For use with 120 volt 60 hertz power source only.**
- Flip top unit plug-in cord drops down from bottom of unit to plug into external power outlet.
- Flip top unit must be field installed on worksurfaces by field cutting hole.
- Application may require approval of local authority having jurisdiction (AHJ); ensure compliance before placing orders and installation.

To Order, Specify:

- 1) Product number.
(No finish specification required.)

Bezel Depth	Bezel Width	Configuration	Number	Price
Corded Single-Sided Outlets				
4.37”(111mm)	5.24”(133mm)	1 Power, 1 Data	EUE1-0000-1111W	\$ 673.88
		2 Power, 0 Data	EUE1-0000-1B01W	673.88
4.37”(111mm)	8.31”(211mm)	2 Power, 2 Data	EUE1-0000-1221W	874.30
		3 Power, 1 Data	EUE1-0000-1311W	874.30
	11.25”(286mm)	3 Power, 3 Data	EUE1-0000-1331W	874.30
		4 Power, 2 Data	EUE1-0000-1421W	874.30
Corded Double-Sided Outlets				
8”(203mm)	8.31”(211mm)	2 Power, 2 Data	EUE2-0000-1221W	\$ 1748.53
		3 Power, 1 Data	EUE2-0000-1311W	1748.53
	11.25”(286mm)	3 Power, 3 Data	EUE2-0000-1331W	1748.53
		4 Power, 2 Data	EUE2-0000-1421W	1748.53
Hardwire Single-Sided Outlets				
4.37”(111mm)	8.31”(211mm)	2 Power, 2 Data	EUE1-0000-C221W	\$ 907.18
		3 Power, 3 Data	EUE1-0000-C331W	907.18
Hardwire Double-Sided Outlets				
8”(203mm)	8.31”(211mm)	2 Power, 2 Data	EUE2-0000-C221W	\$1904.81
		3 Power, 3 Data	EUE2-0000-C331W	1904.81

Worksurface Power Modules — Flip Top

Non-Powered

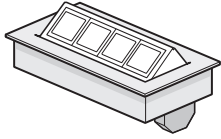

EUE1-000B

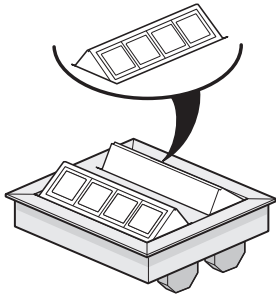

EUE2-000B



Class YA

Features

- Includes bezel and nonpowered flip top module with 2, 4 or 6 ports that can be configured with data ports or cable bays and mounting hardware.
- Data port accommodate most varieties of field supplied data/ AV jacks.
- Each Cable Bay can accept up to 2 pull out data/AV cables
- Flip top unit is flush mounted with spring release flip module(s).
- Flip top unit overall height is 2.75"(70mm) and will extend below the table tops.
- Color option of black anodized housing with black receptacles or clear anodized housing with white receptacles.
- Ships assembled.

Specification Tips

- Designed to be used with 1.18"(30mm) and 2"(51mm)thick surfaces with clear space below.
- **Configuration and quantity of power and data ports cannot be modified in the field.**
- Requires field installation.
- Specify factory cut hole or field cut hole as required.
- Specify AV cables separately.
- Cable Bay requires cables less than 0.3"(8mm) diameter.
- Application may require approval of local authority having jurisdiction (AHJ); ensure compliance before placing orders and installation.

To Order, Specify:

- 1) Product number.
(No finish specification required.)

Bezel Depth	Bezel Width	Trim Color	Port Color	Port	Configuration	Number	Price
Single-Sided Outlets							
4.37"(111mm)	5.32"(135mm)	Black Anodized	Black	2	1 Cable Bay	EUE1-000B-0002	\$ 1179.39
					2 Data Ports	EUE1-000B-0020	1179.39
4.37"(111mm)	8.31"(211mm)			4	2 Data Ports, 1 Cable Bay	EUE1-000B-0022	\$ 1179.39
					4 Data Ports	EUE1-000B-0040	1179.39
4.37"(111mm)	11.3"(287mm)			6	4 Data Ports, 1 Cable Bay	EUE1-000B-0042	\$ 1179.39
					6 Data Ports	EUE1-000B-0060	1179.39
4.37"(111mm)	5.32"(135mm)	Clear Anodized	White	2	1 Cable Bay	EUE1-000W-0002	\$ 879.80
					2 Data Ports	EUE1-000W-0020	879.80
4.37"(111mm)	8.31"(211mm)			4	2 Data Ports, 1 Cable Bay	EUE1-000W-0022	\$ 879.80
					4 Data Ports	EUE1-000W-0040	879.80
4.37"(111mm)	11.3"(287mm)			6	4 Data Ports, 1 Cable Bay	EUE1-000W-0042	\$ 879.80
					6 Data Ports	EUE1-000W-0060	879.80
Double-Sided Outlets							
8.07"(205mm)	8.31"(211mm)	Black Anodized	Black	4	2 Data Ports, 1 Cable Bay	EUE2-000B-0022	\$2053.62
					4 Data Ports	EUE2-000B-0040	2053.62
8.07"(205mm)	11.3"(287mm)			6	4 Data Ports, 1 Cable Bay	EUE2-000B-0042	\$2053.62
					6 Data Ports	EUE2-000B-0060	2053.62
8.07"(205mm)	8.31"(211mm)	Clear Anodized	White	4	2 Data Ports, 1 Cable Bay	EUE2-000W-0022	\$ 1754.03
					4 Data Ports	EUE2-000W-0040	1754.03
8.07"(205mm)	11.3"(287mm)			6	4 Data Ports, 1 Cable Bay	EUE2-000W-0042	\$ 1754.03
					6 Data Ports	EUE2-000W-0060	1754.03

Worksurface Power Modules — Flip Top

Corded — Single-Sided

Power, Data and USB

4-Port:

- (2) Power
- (1) Smart USB-A+C
- (1) Data

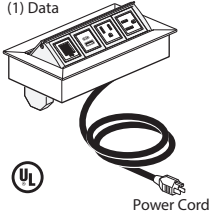

Power Cord

EUE1-PF0B-2110

6-Port:

- (4) Power
- (1) Smart USB-A+C
- (1) Data

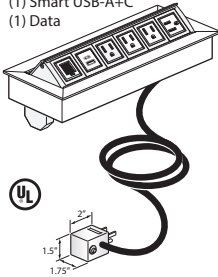

NOTE:
Always Circuit Breaker Plug when more than three power outlets specified.

EUE1-PF0B-1212

4-Port:

- (4) Power

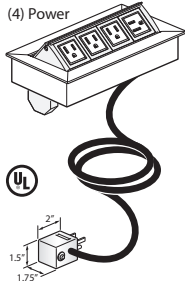

NOTE:
Always Circuit Breaker Plug when more than three power outlets specified.

EUE1-PF0B-4000

Class YA

Features

- Includes bezel and flip top module with 2, 4 or 6 ports that can be configured with simplex outlets (NEMA-5-15R), USB charging port (Smart USB-A+C), data ports or cable bay(s) that can accept up to 2 pull out data/AV cables and mounting hardware.
- Data port accommodate most varieties of field supplied data/ AV jacks.
- Corded power module available with 15 amp - 6'(1829mm) or 12'(3658mm) long cord with plug (NEMA 5-15P).
- The Smart USB-A+C allows for the 20W to be transferred between the 2 ports. If the USB-A is being used, the full wattage is sent to the USB-A, and the same for the USB-C. If both are being used, the wattage is distributed to each port and the port drawing the most power will receive more watts than the one that is not.
- Flip top unit is flush mounted with spring release flip module.
- Flip top unit overall height is 2.75"(70mm) and will extend below the table tops.
- Color option of black anodized housing with black receptacles or clear anodized housing with white receptacles.
- Ships assembled.

Specification Tips

- Designed to be used with 1.18"(30mm) and 2"(51mm) thick surfaces with clear space below.
- **Configuration and quantity of power and data ports cannot be modified in the field.**
- **For use with 120 volt 60 hertz power source only.**
- Requires field installation.
- Specify factory cut hole or field cut hole as required.
- Specify AV cables separately.
- Cable Bay requires cables less than 0.3"(8mm) diameter.
- Application may require approval of local authority having jurisdiction (AHJ); ensure compliance before placing orders and installation.

To Order, Specify:

- 1) Product number.
(No finish specification required.)

Note: Order flip top units to match flip top unit cutout option specified for each top (A/B, F/V or J/K).

Worksurface Power Modules — Flip Top

Corded — Single-Sided

Bezel Depth	Bezel Width	Cord Length	Trim Color	Port Color	Port	Port Configuration	Cutout	Number	Price
							Code Options		
4.73" (111mm)	5.31" (135mm)	6' (1829mm)	Black Anodized	Black	2	1 Power Receptacle, 1 Data Port	A, B	EUE1-PFOB-1010	\$ 1179.39
						1 Power Receptacle, 1 Smart USB-A+C Charging	A, B	EUE1-PFOB-1100	1290.16
						2 Power Receptacles	A, B	EUE1-PFOB-2000	1179.39
4.37" (111mm)	8.31" (211mm)				4	1 Power Receptacle, 1 Data Port, 1 Cable Bay	F, V	EUE1-PFOB-1012	\$ 1179.39
						1 Power Receptacle, 3 Data Ports	F, V	EUE1-PFOB-1030	1179.39
						1 Power Receptacle, 1 Smart USB-A+C Charging, 1 Cable Bay	F, V	EUE1-PFOB-1102	1290.16
						1 Power Receptacle, 1 Smart USB-A+C Charging, 2 Data Ports	F, V	EUE1-PFOB-1120	1290.16
						1 Power Receptacle, 3 Smart USB-A+C Charging	F, V	EUE1-PFOB-1300	1511.70
						2 Power Receptacles, 1 Cable Bay	F, V	EUE1-PFOB-2002	1179.39
						2 Power Receptacles, 2 Data Ports	F, V	EUE1-PFOB-2020	1179.39
						2 Power Receptacles, 1 Smart USB-A+C Charging, 1 Data Port	F, V	EUE1-PFOB-2110	1290.16
						2 Power Receptacles, 2 Smart USB-A+C Charging	F, V	EUE1-PFOB-2200	1400.93
						3 Power Receptacles, 1 Data Port	F, V	EUE1-PFOB-3010	1179.39
						3 Power Receptacles, 1 Smart USB-A+C Charging	F, V	EUE1-PFOB-3100	1290.16
						4 Power Receptacles	F, V	EUE1-PFOB-4000	1179.39
						4.37" (111mm)	11.3" (287mm)		
1 Power Receptacle, 5 Data Ports	J, K	EUE1-PFOB-1050	1179.39						
1 Power Receptacle, 1 Smart USB-A+C Charging, 2 Data Ports, 1 Cable Bay	J, K	EUE1-PFOB-1122	1290.16						
1 Power Receptacle, 1 Smart USB-A+C Charging, 4 Data Ports	J, K	EUE1-PFOB-1140	1290.16						
1 Power Receptacle, 2 Smart USB-A+C Charging, 1 Data Port, 1 Cable Bay	J, K	EUE1-PFOB-1212	1400.93						
1 Power Receptacle, 2 Smart USB-A+C Charging, 3 Data Ports	J, K	EUE1-PFOB-1230	1400.93						
1 Power Receptacle, 3 Smart USB-A+C Charging, 1 Cable Bay	J, K	EUE1-PFOB-1302	1511.70						
1 Power Receptacle, 3 Smart USB-A+C Charging, 2 Data Ports	J, K	EUE1-PFOB-1320	1511.70						
2 Power Receptacles, 2 Data Ports, 1 Cable Bay	J, K	EUE1-PFOB-2022	1179.39						
2 Power Receptacles, 4 Data Ports	J, K	EUE1-PFOB-2040	1179.39						
2 Power Receptacles, 1 Smart USB-A+C Charging, 1 Data Port, 1 Cable Bay	J, K	EUE1-PFOB-2112	1290.16						
2 Power Receptacles, 1 Smart USB-A+C Charging, 3 Data Ports	J, K	EUE1-PFOB-2130	1290.16						
2 Power Receptacles, 2 Smart USB-A+C Charging, 1 Cable Bay	J, K	EUE1-PFOB-2202	1400.93						
2 Power Receptacles, 2 Smart USB-A+C Charging, 2 Data Ports	J, K	EUE1-PFOB-2220	1400.93						
2 Power Receptacles, 3 Smart USB-A+C Charging, 1 Data Port	J, K	EUE1-PFOB-2310	1511.70						
2 Power Receptacles, 4 Smart USB-A+C Charging	J, K	EUE1-PFOB-2400	1622.47						
3 Power Receptacles, 1 Data Port, 1 Cable Bay	J, K	EUE1-PFOB-3012	1179.39						
3 Power Receptacles, 3 Data Ports	J, K	EUE1-PFOB-3030	1179.39						
3 Power Receptacles, 1 Smart USB-A+C Charging, 1 Cable Bay	J, K	EUE1-PFOB-3102	1290.16						
3 Power Receptacles, 1 Smart USB-A+C Charging, 2 Data Ports	J, K	EUE1-PFOB-3120	1290.16						
3 Power Receptacles, 2 Smart USB-A+C Charging, 1 Data Port	J, K	EUE1-PFOB-3210	1400.93						
3 Power Receptacles, 3 Smart USB-A+C Charging	J, K	EUE1-PFOB-3300	1511.70						
4 Power Receptacles, 1 Cable Bay	J, K	EUE1-PFOB-4002	1179.39						
4 Power Receptacles, 2 Data Ports	J, K	EUE1-PFOB-4020	1179.39						
4 Power Receptacles, 1 Smart USB-A+C Charging, 1 Data Port	J, K	EUE1-PFOB-4110	1290.16						
4 Power Receptacles, 2 Smart USB-A+C Charging	J, K	EUE1-PFOB-4200	1400.93						
5 Power Receptacles, 1 Data Port	J, K	EUE1-PFOB-5010	1179.39						
5 Power Receptacles, 1 Smart USB-A+C Charging	J, K	EUE1-PFOB-5100	1290.16						
6 Power Receptacles	J, K	EUE1-PFOB-6000	1179.39						

Worksurface Power Modules — Flip Top

Corded — Single-Sided

Bezel Depth	Bezel Width	Cord Length	Trim Color	Port Color	Port	Port Configuration	Cutout Code	Options	Number	Price
4.37" (111mm)	5.31" (135mm)	6' (1829mm)	Clear Anodized	White	2	1 Power Receptacle, 1 Data Port	A, B		EUE1-PFOW-1010	\$ 879.80
						1 Power Receptacle, 1 Smart USB-A+C Charging	A, B		EUE1-PFOW-1100	990.57
						2 Power Receptacles	A, B		EUE1-PFOW-2000	879.80
4.37" (111mm)	8.31" (211mm)				4	1 Power Receptacle, 1 Data Port, 1 Cable Bay	F, V		EUE1-PFOW-1012	\$ 879.80
						1 Power Receptacle, 3 Data Ports	F, V		EUE1-PFOW-1030	879.80
						1 Power Receptacle, 1 Smart USB-A+C Charging, 1 Cable Bay	F, V		EUE1-PFOW-1102	990.57
						1 Power Receptacle, 1 Smart USB-A+C Charging, 2 Data Ports	F, V		EUE1-PFOW-1120	990.57
						1 Power Receptacle, 3 Smart USB-A+C Charging	F, V		EUE1-PFOW-1300	1212.11
						2 Power Receptacles, 1 Cable Bay	F, V		EUE1-PFOW-2002	879.80
						2 Power Receptacles, 2 Data Ports	F, V		EUE1-PFOW-2020	879.80
						2 Power Receptacles, 1 Smart USB-A+C Charging, 1 Data Port	F, V		EUE1-PFOW-2110	990.57
						2 Power Receptacles, 2 Smart USB-A+C Charging	F, V		EUE1-PFOW-2200	1101.34
						3 Power Receptacles, 1 Data Port	F, V		EUE1-PFOW-3010	879.80
						3 Power Receptacles, 1 Smart USB-A+C Charging	F, V		EUE1-PFOW-3100	990.57
						4 Power Receptacles	F, V		EUE1-PFOW-4000	879.80
						4.37" (111mm)	11.3" (287mm)			
1 Power Receptacle, 5 Data Ports	J, K		EUE1-PFOW-1050	879.80						
1 Power Receptacle, 1 Smart USB-A+C Charging, 2 Data Ports, 1 Cable Bay	J, K		EUE1-PFOW-1122	990.57						
1 Power Receptacle, 1 Smart USB-A+C Charging, 4 Data Ports	J, K		EUE1-PFOW-1140	990.57						
1 Power Receptacle, 2 Smart USB-A+C Charging, 1 Data Port, 1 Cable Bay	J, K		EUE1-PFOW-1212	1101.34						
1 Power Receptacle, 2 Smart USB-A+C Charging, 3 Data Ports	J, K		EUE1-PFOW-1230	1101.34						
1 Power Receptacle, 3 Smart USB-A+C Charging, 1 Cable Bay	J, K		EUE1-PFOW-1302	1212.11						
1 Power Receptacle, 3 Smart USB-A+C Charging, 2 Data Ports	J, K		EUE1-PFOW-1320	1212.11						
2 Power Receptacles, 2 Data Ports, 1 Cable Bay	J, K		EUE1-PFOW-2022	879.80						
2 Power Receptacles, 4 Data Ports	J, K		EUE1-PFOW-2040	879.80						
2 Power Receptacles, 1 Smart USB-A+C Charging, 1 Data Port, 1 Cable Bay	J, K		EUE1-PFOW-2112	990.57						
2 Power Receptacles, 1 Smart USB-A+C Charging, 3 Data Ports	J, K		EUE1-PFOW-2130	990.57						
2 Power Receptacles, 2 Smart USB-A+C Charging, 1 Cable Bay	J, K		EUE1-PFOW-2202	1101.34						
2 Power Receptacles, 2 Smart USB-A+C Charging, 2 Data Ports	J, K		EUE1-PFOW-2220	1101.34						
2 Power Receptacles, 3 Smart USB-A+C Charging, 1 Data Port	J, K		EUE1-PFOW-2310	1212.11						
2 Power Receptacles, 4 Smart USB-A+C Charging	J, K		EUE1-PFOW-2400	1322.88						
3 Power Receptacles, 1 Data Port, 1 Cable Bay	J, K		EUE1-PFOW-3012	879.80						
3 Power Receptacles, 3 Data Ports	J, K		EUE1-PFOW-3030	879.80						
3 Power Receptacles, 1 Smart USB-A+C Charging, 1 Cable Bay	J, K		EUE1-PFOW-3102	990.57						
3 Power Receptacles, 1 Smart USB-A+C Charging, 2 Data Ports	J, K		EUE1-PFOW-3120	990.57						
3 Power Receptacles, 2 Smart USB-A+C Charging, 1 Data Port	J, K		EUE1-PFOW-3210	1101.34						
3 Power Receptacles, 3 Smart USB-A+C Charging	J, K		EUE1-PFOW-3300	1212.11						
4 Power Receptacles, 1 Cable Bay	J, K		EUE1-PFOW-4002	879.80						
4 Power Receptacles, 2 Data Ports	J, K		EUE1-PFOW-4020	879.80						
4 Power Receptacles, 1 Smart USB-A+C Charging, 1 Data Port	J, K		EUE1-PFOW-4110	990.57						
4 Power Receptacles, 2 Smart USB-A+C Charging	J, K		EUE1-PFOW-4200	1101.34						
5 Power Receptacles, 1 Data Port	J, K		EUE1-PFOW-5010	879.80						
5 Power Receptacles, 1 Smart USB-A+C Charging	J, K		EUE1-PFOW-5100	990.57						
6 Power Receptacles	J, K		EUE1-PFOW-6000	879.80						

Worksurface Power Modules — Flip Top

Corded — Single-Sided

Bezel Depth	Bezel Width	Cord Length	Trim Color	Port Color	Port	Port Configuration	Cutout	Number	Price
							Code Options		
4.37" (111mm)	5.31" (135mm)	12'	Black Anodized	Black	2	1 Power Receptacle, 1 Data Port	A, B	EUE1-PL0B-1010	\$1269.91
						1 Power Receptacle, 1 Smart USB-A+C Charging	A, B	EUE1-PL0B-1100	1380.68
						2 Power Receptacles	A, B	EUE1-PL0B-2000	1269.91
4.37" (111mm)	8.31" (211mm)				4	1 Power Receptacle, 1 Data Port, 1 Cable Bay	F, V	EUE1-PL0B-1012	\$1269.91
						1 Power Receptacle, 3 Data Ports	F, V	EUE1-PL0B-1030	1269.91
						1 Power Receptacle, 1 Smart USB-A+C Charging, 1 Cable Bay	F, V	EUE1-PL0B-1102	1380.68
						1 Power Receptacle, 1 Smart USB-A+C Charging, 2 Data Ports	F, V	EUE1-PL0B-1120	1380.68
						1 Power Receptacle, 3 Smart USB-A+C Charging	F, V	EUE1-PL0B-1300	1602.22
						2 Power Receptacles, 1 Cable Bay	F, V	EUE1-PL0B-2002	1269.91
						2 Power Receptacles, 2 Data Ports	F, V	EUE1-PL0B-2020	1269.91
						2 Power Receptacles, 1 Smart USB-A+C Charging, 1 Data Port	F, V	EUE1-PL0B-2110	1380.68
						2 Power Receptacles, 2 Smart USB-A+C Charging	F, V	EUE1-PL0B-2200	1491.45
						3 Power Receptacles, 1 Data Port	F, V	EUE1-PL0B-3010	1269.91
						3 Power Receptacles, 1 Smart USB-A+C Charging	F, V	EUE1-PL0B-3100	1380.68
						4 Power Receptacles	F, V	EUE1-PL0B-4000	1269.91
						4.37" (111mm)	11.3" (287mm)		
1 Power Receptacle, 5 Data Ports	J, K	EUE1-PL0B-1050	1269.91						
1 Power Receptacle, 1 Smart USB-A+C Charging, 2 Data Ports, 1 Cable Bay	J, K	EUE1-PL0B-1122	1380.68						
1 Power Receptacle, 1 Smart USB-A+C Charging, 4 Data Ports	J, K	EUE1-PL0B-1140	1380.68						
1 Power Receptacle, 2 Smart USB-A+C Charging, 1 Data Port, 1 Cable Bay	J, K	EUE1-PL0B-1212	1491.45						
1 Power Receptacle, 2 Smart USB-A+C Charging, 3 Data Ports	J, K	EUE1-PL0B-1230	1491.45						
1 Power Receptacle, 3 Smart USB-A+C Charging, 1 Cable Bay	J, K	EUE1-PL0B-1302	1602.22						
1 Power Receptacle, 3 Smart USB-A+C Charging, 2 Data Ports	J, K	EUE1-PL0B-1320	1602.22						
2 Power Receptacles, 2 Data Ports, 1 Cable Bay	J, K	EUE1-PL0B-2022	1269.91						
2 Power Receptacles, 4 Data Ports	J, K	EUE1-PL0B-2040	1269.91						
2 Power Receptacles, 1 Smart USB-A+C Charging, 1 Data Port, 1 Cable Bay	J, K	EUE1-PL0B-2112	1380.68						
2 Power Receptacles, 1 Smart USB-A+C Charging, 3 Data Ports	J, K	EUE1-PL0B-2130	1380.68						
2 Power Receptacles, 2 Smart USB-A+C Charging, 1 Cable Bay	J, K	EUE1-PL0B-2202	1491.45						
2 Power Receptacles, 2 Smart USB-A+C Charging, 2 Data Ports	J, K	EUE1-PL0B-2220	1491.45						
2 Power Receptacles, 3 Smart USB-A+C Charging, 1 Data Port	J, K	EUE1-PL0B-2310	1602.22						
2 Power Receptacles, 4 Smart USB-A+C Charging	J, K	EUE1-PL0B-2400	1712.99						
3 Power Receptacles, 1 Data Port, 1 Cable Bay	J, K	EUE1-PL0B-3012	1269.91						
3 Power Receptacles, 3 Data Ports	J, K	EUE1-PL0B-3030	1269.91						
3 Power Receptacles, 1 Smart USB-A+C Charging, 1 Cable Bay	J, K	EUE1-PL0B-3102	1380.68						
3 Power Receptacles, 1 Smart USB-A+C Charging, 2 Data Ports	J, K	EUE1-PL0B-3120	1380.68						
3 Power Receptacles, 2 Smart USB-A+C Charging, 1 Data Port	J, K	EUE1-PL0B-3210	1491.45						
3 Power Receptacles, 3 Smart USB-A+C Charging	J, K	EUE1-PL0B-3300	1602.22						
4 Power Receptacles, 1 Cable Bay	J, K	EUE1-PL0B-4002	1269.91						
4 Power Receptacles, 2 Data Ports	J, K	EUE1-PL0B-4020	1269.91						
4 Power Receptacles, 1 Smart USB-A+C Charging, 1 Data Port	J, K	EUE1-PL0B-4110	1380.68						
4 Power Receptacles, 2 Smart USB-A+C Charging	J, K	EUE1-PL0B-4200	1491.45						
5 Power Receptacles, 1 Data Port	J, K	EUE1-PL0B-5010	1269.91						
5 Power Receptacles, 1 Smart USB-A+C Charging	J, K	EUE1-PL0B-5100	1380.68						
6 Power Receptacles	J, K	EUE1-PL0B-6000	1269.91						

Worksurface Power Modules — Flip Top

Corded — Single-Sided

Bezel Depth	Bezel Width	Cord Length	Trim Color	Port Color	Port	Port Configuration	Cutout		Price
							Code	Options Number	
4.37" (111mm)	5.31" (135mm)	12'	Clear Anodized	White	2	1 Power Receptacle, 1 Data Port	A, B	EUE1-PLow-1010	\$ 970.32
						1 Power Receptacle, 1 Smart USB-A+C Charging	A, B	EUE1-PLow-1100	1081.09
						2 Power Receptacles	A, B	EUE1-PLow-2000	970.32
4.37" (111mm)	8.31" (211mm)				4	1 Power Receptacle, 1 Data Port, 1 Cable Bay	F, V	EUE1-PLow-1012	\$ 970.32
						1 Power Receptacle, 3 Data Ports	F, V	EUE1-PLow-1030	970.32
						1 Power Receptacle, 1 Smart USB-A+C Charging, 1 Cable Bay	F, V	EUE1-PLow-1102	1081.09
						1 Power Receptacle, 1 Smart USB-A+C Charging, 2 Data Ports	F, V	EUE1-PLow-1120	1081.09
						1 Power Receptacle, 3 Smart USB-A+C Charging	F, V	EUE1-PLow-1300	1302.63
						2 Power Receptacles, 1 Cable Bay	F, V	EUE1-PLow-2002	970.32
						2 Power Receptacles, 2 Data Ports	F, V	EUE1-PLow-2020	970.32
						2 Power Receptacles, 1 Smart USB-A+C Charging, 1 Data Port	F, V	EUE1-PLow-2110	1081.09
						2 Power Receptacles, 2 Smart USB-A+C Charging	F, V	EUE1-PLow-2200	1191.86
						3 Power Receptacles, 1 Data Port	F, V	EUE1-PLow-3010	970.32
						3 Power Receptacles, 1 Smart USB-A+C Charging	F, V	EUE1-PLow-3100	1081.09
						4 Power Receptacles	F, V	EUE1-PLow-4000	970.32
						4.37" (111mm)	11.3" (287mm)		
1 Power Receptacle, 5 Data Ports	J, K	EUE1-PLow-1050	970.32						
1 Power Receptacle, 1 Smart USB-A+C Charging, 2 Data Ports, 1 Cable Bay	J, K	EUE1-PLow-1122	1081.09						
1 Power Receptacle, 1 Smart USB-A+C Charging, 4 Data Ports	J, K	EUE1-PLow-1140	1081.09						
1 Power Receptacle, 2 Smart USB-A+C Charging, 1 Data Port, 1 Cable Bay	J, K	EUE1-PLow-1212	1191.86						
1 Power Receptacle, 2 Smart USB-A+C Charging, 3 Data Ports	J, K	EUE1-PLow-1230	1191.86						
1 Power Receptacle, 3 Smart USB-A+C Charging, 1 Cable Bay	J, K	EUE1-PLow-1302	1302.63						
1 Power Receptacle, 3 Smart USB-A+C Charging, 2 Data Ports	J, K	EUE1-PLow-1320	1302.63						
2 Power Receptacles, 2 Data Ports, 1 Cable Bay	J, K	EUE1-PLow-2022	970.32						
2 Power Receptacles, 4 Data Ports	J, K	EUE1-PLow-2040	970.32						
2 Power Receptacles, 1 Smart USB-A+C Charging, 1 Data Port, 1 Cable Bay	J, K	EUE1-PLow-2112	1081.09						
2 Power Receptacles, 1 Smart USB-A+C Charging, 3 Data Ports	J, K	EUE1-PLow-2130	1081.09						
2 Power Receptacles, 2 Smart USB-A+C Charging, 1 Cable Bay	J, K	EUE1-PLow-2202	1191.86						
2 Power Receptacles, 2 Smart USB-A+C Charging, 2 Data Ports	J, K	EUE1-PLow-2220	1191.86						
2 Power Receptacles, 3 Smart USB-A+C Charging, 1 Data Port	J, K	EUE1-PLow-2310	1302.63						
2 Power Receptacles, 4 Smart USB-A+C Charging	J, K	EUE1-PLow-2400	1413.40						
3 Power Receptacles, 1 Data Port, 1 Cable Bay	J, K	EUE1-PLow-3012	970.32						
3 Power Receptacles, 3 Data Ports	J, K	EUE1-PLow-3030	970.32						
3 Power Receptacles, 1 Smart USB-A+C Charging, 1 Cable Bay	J, K	EUE1-PLow-3102	1081.09						
3 Power Receptacles, 1 Smart USB-A+C Charging, 2 Data Ports	J, K	EUE1-PLow-3120	1081.09						
3 Power Receptacles, 2 Smart USB-A+C Charging, 1 Data Port	J, K	EUE1-PLow-3210	1191.86						
3 Power Receptacles, 3 Smart USB-A+C Charging	J, K	EUE1-PLow-3300	1302.63						
4 Power Receptacles, 1 Cable Bay	J, K	EUE1-PLow-4002	970.32						
4 Power Receptacles, 2 Data Ports	J, K	EUE1-PLow-4020	970.32						
4 Power Receptacles, 1 Smart USB-A+C Charging, 1 Data Port	J, K	EUE1-PLow-4110	1081.09						
4 Power Receptacles, 2 Smart USB-A+C Charging	J, K	EUE1-PLow-4200	1191.86						
5 Power Receptacles, 1 Data Port	J, K	EUE1-PLow-5010	970.32						
5 Power Receptacles, 1 Smart USB-A+C Charging	J, K	EUE1-PLow-5100	1081.09						
6 Power Receptacles	J, K	EUE1-PLow-6000	970.32						

Worksurface Power Modules — Flip Top

Corded — Double-Sided

Power, Data and USB

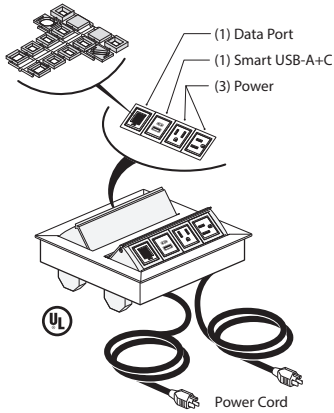

EUE2-PF0B-2110

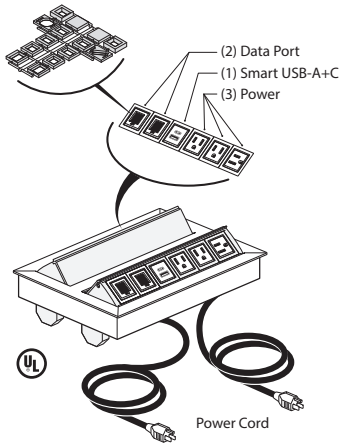

EUE2-PF0B-1212

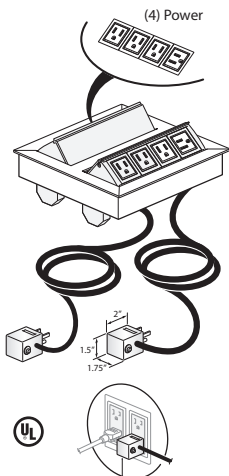

EUE2-PF0B-4000

Class YA

Features

- Includes bezel and two flip top modules, each flip top module with 2, 4 or 6 ports that can be configured with simplex outlets (NEMA-5-15R), USB charging port (Smart USB-A+C) data ports or cable bay(s) that can accept up to 2 pull out data/AV cables and mounting hardware.
- Data port accommodate most varieties of field supplied data/ AV jacks.
- Each flip top module within the bezel provided with 15 amp - 6' (1829mm) or 12' (3658mm) long cord with plug (NEMA5-15P).
- The Smart USB-A+C allows for the 20W to be transferred between the 2 ports. If the USB-A is being used, the full wattage is sent to the USB-A, and the same for the USB-C. If both are being used, the wattage is distributed to each port and the port drawing the most power will receive more watts than the one that is not.
- Flip top unit is flush mounted with spring release flip module.
- Flip top unit overall height is 2.75" (70mm) and will extend below the table tops.
- Color option of black anodized housing with black receptacles or clear anodized housing with white receptacles.
- Ships assembled.

Specification Tips

- Designed to be used with 1.18" (30mm) and 2" (51mm) thick surfaces with clear space below.
 - **Configuration and quantity of power and data ports cannot be modified in the field.**
 - **For use with 120 volt 60 hertz power source only.**
 - Requires field installation.
 - Specify factory cut hole or field cut hole as required.
 - Specify AV cables separately.
 - Cable Bay requires cables less than 0.3" (8mm) diameter.
 - Application may require approval of local authority having jurisdiction (AHJ); ensure compliance before placing orders and installation.
- Two cord feeds are provided from the double-sided flip top unit.

To Order, Specify:

- 1) Product number.
(No finish specification required.)

Note: Order flip top units to match flip top unit cutout option specified for each top (M/P or Q/T).

Worksurface Power Modules — Flip Top

Corded — Double-Sided

Bezel Depth	Bezel Width	Cord Length	Trim Color	Port Color	Port	Port Configuration	Cutout	Number	Price	
							Code			Options
8" (203mm)	5.31" (135mm)	6' (1829mm)	Black Anodized	Black	4	1 Power Receptacle, 1 Data Port, 1 Cable Bay	M, P	EUE2-PFOB-1012	\$2053.62	
						1 Power Receptacle, 3 Data Ports	M, P	EUE2-PFOB-1030	2053.62	
						1 Power Receptacle, 1 Smart USB-A+C Charging, 1 Cable Bay	M, P	EUE2-PFOB-1102	2164.39	
						1 Power Receptacle, 1 Smart USB-A+C Charging, 2 Data Ports	M, P	EUE2-PFOB-1120	2164.39	
						1 Power Receptacle, 3 Smart USB-A+C Charging	M, P	EUE2-PFOB-1300	2385.93	
						2 Power Receptacles, 1 Cable Bay	M, P	EUE2-PFOB-2002	2053.62	
						2 Power Receptacles, 2 Data Ports	M, P	EUE2-PFOB-2020	2053.62	
						2 Power Receptacles, 1 Smart USB-A+C Charging, 1 Data Port	M, P	EUE2-PFOB-2110	2164.39	
						2 Power Receptacles, 2 Smart USB-A+C Charging	M, P	EUE2-PFOB-2200	2275.16	
						3 Power Receptacles, 1 Data Port	M, P	EUE2-PFOB-3010	2053.62	
						3 Power Receptacles, 1 Smart USB-A+C Charging	M, P	EUE2-PFOB-3100	2164.39	
						4 Power Receptacles	M, P	EUE2-PFOB-4000	2053.62	
						6	1 Power Receptacle, 3 Data Ports, 1 Cable Bay	Q, T	EUE2-PFOB-1032	\$2053.62
							1 Power Receptacle, 5 Data Ports	Q, T	EUE2-PFOB-1050	2053.62
							1 Power Receptacle, 1 Smart USB-A+C Charging, 2 Data Ports, 1 Cable Bay	Q, T	EUE2-PFOB-1122	2164.39
							1 Power Receptacle, 1 Smart USB-A+C Charging, 4 Data Ports	Q, T	EUE2-PFOB-1140	2164.39
					1 Power Receptacle, 2 Smart USB-A+C Charging, 1 Data Port, 1 Cable Bay		Q, T	EUE2-PFOB-1212	2275.16	
					1 Power Receptacle, 2 Smart USB-A+C Charging, 3 Data Ports		Q, T	EUE2-PFOB-1230	2275.16	
					1 Power Receptacle, 3 Smart USB-A+C Charging, 2 Cable Bays		Q, T	EUE2-PFOB-1302	2385.93	
					1 Power Receptacle, 3 Smart USB-A+C Charging, 2 Data Ports		Q, T	EUE2-PFOB-1320	2385.93	
					2 Power Receptacles, 2 Data Ports, 2 Cable Bays		Q, T	EUE2-PFOB-2022	2053.62	
					2 Power Receptacles, 4 Data Ports		Q, T	EUE2-PFOB-2040	2053.62	
					2 Power Receptacles, 1 Smart USB-A+C Charging, 1 Data Port, 2 Cable Bays		Q, T	EUE2-PFOB-2112	2164.39	
					2 Power Receptacles, 1 Smart USB-A+C Charging, 3 Data Ports		Q, T	EUE2-PFOB-2130	2164.39	
					2 Power Receptacles, 2 Smart USB-A+C Charging, 2 Cable Bays		Q, T	EUE2-PFOB-2202	2275.16	
					2 Power Receptacles, 2 Smart USB-A+C Charging, 2 Data Ports		Q, T	EUE2-PFOB-2220	2275.16	
					2 Power Receptacles, 3 Smart USB-A+C Charging, 1 Data Port		Q, T	EUE2-PFOB-2310	2385.93	
					2 Power Receptacles, 4 Smart USB-A+C Charging		Q, T	EUE2-PFOB-2400	2496.70	
					3 Power Receptacles, 1 Data Port, 2 Cable Bays	Q, T	EUE2-PFOB-3012	2053.62		
					3 Power Receptacles, 3 Data Ports	Q, T	EUE2-PFOB-3030	2053.62		
					3 Power Receptacles, 1 Smart USB-A+C Charging, 2 Cable Bays	Q, T	EUE2-PFOB-3102	2164.39		
					3 Power Receptacles, 1 Smart USB-A+C Charging, 2 Data Ports	Q, T	EUE2-PFOB-3120	2164.39		
3 Power Receptacles, 2 Smart USB-A+C Charging, 1 Data Port	Q, T	EUE2-PFOB-3210	2275.16							
3 Power Receptacles, 3 Smart USB-A+C Charging	Q, T	EUE2-PFOB-3300	2385.93							
4 Power Receptacles, 2 Cable Bays	Q, T	EUE2-PFOB-4002	2053.62							
4 Power Receptacles, 2 Data Ports	Q, T	EUE2-PFOB-4020	2053.62							
4 Power Receptacles, 1 Smart USB-A+C Charging, 1 Data Port	Q, T	EUE2-PFOB-4110	2164.39							
4 Power Receptacles, 2 Smart USB-A+C Charging	Q, T	EUE2-PFOB-4200	2275.16							
5 Power Receptacles, 1 Data Port	Q, T	EUE2-PFOB-5010	2053.62							
5 Power Receptacles, 1 Smart USB-A+C Charging	Q, T	EUE2-PFOB-5100	2164.39							
6 Power Receptacles	Q, T	EUE2-PFOB-6000	2053.62							

Worksurface Power Modules — Flip Top

Corded — Double-Sided

Bezel Depth	Bezel Width	Cord Length	Trim Color	Port Color	Port	Port Configuration	Cutout	Number	Price	
							Code			
							Options			
8" (203mm)	5.31" (135mm)	6' (1829mm)	Clear Anodized	White	4	1 Power Receptacle, 1 Data Port, 1 Cable Bay	M, P	EUE2-PFOW-1012	\$ 1754.03	
						1 Power Receptacle, 3 Data Ports	M, P	EUE2-PFOW-1030	1754.03	
						1 Power Receptacle, 1 Smart USB-A+C Charging, 1 Cable Bay	M, P	EUE2-PFOW-1102	1864.80	
						1 Power Receptacle, 1 Smart USB-A+C Charging, 2 Data Ports	M, P	EUE2-PFOW-1120	1864.80	
						1 Power Receptacle, 3 Smart USB-A+C Charging	M, P	EUE2-PFOW-1300	2086.34	
						2 Power Receptacles, 1 Cable Bay	M, P	EUE2-PFOW-2002	1754.03	
						2 Power Receptacles, 2 Data Ports	M, P	EUE2-PFOW-2020	1754.03	
						2 Power Receptacles, 1 Smart USB-A+C Charging, 1 Data Port	M, P	EUE2-PFOW-2110	1864.80	
						2 Power Receptacles, 2 Smart USB-A+C Charging	M, P	EUE2-PFOW-2200	1975.57	
						3 Power Receptacles, 1 Data Port	M, P	EUE2-PFOW-3010	1754.03	
						3 Power Receptacles, 1 Smart USB-A+C Charging	M, P	EUE2-PFOW-3100	1864.80	
						4 Power Receptacles	M, P	EUE2-PFOW-4000	1754.03	
						6	1 Power Receptacle, 3 Data Ports, 1 Cable Bay	Q, T	EUE2-PFOW-1032	\$ 1754.03
							1 Power Receptacle, 5 Data Ports	Q, T	EUE2-PFOW-1050	1754.03
							1 Power Receptacle, 1 Smart USB-A+C Charging, 2 Data Ports, 1 Cable Bay	Q, T	EUE2-PFOW-1122	1864.80
							1 Power Receptacle, 1 Smart USB-A+C Charging, 4 Data Ports	Q, T	EUE2-PFOW-1140	1864.80
					1 Power Receptacle, 2 Smart USB-A+C Charging, 1 Data Port, 1 Cable Bay		Q, T	EUE2-PFOW-1212	1975.57	
					1 Power Receptacle, 2 Smart USB-A+C Charging, 3 Data Ports		Q, T	EUE2-PFOW-1230	1975.57	
					1 Power Receptacle, 3 Smart USB-A+C Charging, 1 Cable Bay		Q, T	EUE2-PFOW-1302	2086.34	
					1 Power Receptacle, 3 Smart USB-A+C Charging, 2 Data Ports		Q, T	EUE2-PFOW-1320	2086.34	
					2 Power Receptacles, 2 Data Ports, 1 Cable Bay		Q, T	EUE2-PFOW-2022	1754.03	
					2 Power Receptacles, 4 Data Ports		Q, T	EUE2-PFOW-2040	1754.03	
					2 Power Receptacles, 1 Smart USB-A+C Charging, 1 Data Port, 1 Cable Bay		Q, T	EUE2-PFOW-2112	1864.80	
					2 Power Receptacles, 1 Smart USB-A+C Charging, 3 Data Ports		Q, T	EUE2-PFOW-2130	1864.80	
					2 Power Receptacles, 2 Smart USB-A+C Charging, 1 Cable Bay		Q, T	EUE2-PFOW-2202	1975.57	
					2 Power Receptacles, 2 Smart USB-A+C Charging, 2 Data Ports		Q, T	EUE2-PFOW-2220	1975.57	
					2 Power Receptacles, 3 Smart USB-A+C Charging, 1 Data Port		Q, T	EUE2-PFOW-2310	2086.34	
					2 Power Receptacles, 4 Smart USB-A+C Charging		Q, T	EUE2-PFOW-2400	2197.11	
					3 Power Receptacles, 1 Data Port, 1 Cable Bay	Q, T	EUE2-PFOW-3012	1754.03		
					3 Power Receptacles, 3 Data Ports	Q, T	EUE2-PFOW-3030	1754.03		
					3 Power Receptacles, 1 Smart USB-A+C Charging, 1 Cable Bay	Q, T	EUE2-PFOW-3102	1864.80		
					3 Power Receptacles, 1 Smart USB-A+C Charging, 2 Data Ports	Q, T	EUE2-PFOW-3120	1864.80		
3 Power Receptacles, 2 Smart USB-A+C Charging, 1 Data Port	Q, T	EUE2-PFOW-3210	1975.57							
3 Power Receptacles, 3 Smart USB-A+C Charging	Q, T	EUE2-PFOW-3300	2086.34							
4 Power Receptacles, 1 Cable Bay	Q, T	EUE2-PFOW-4002	1754.03							
4 Power Receptacles, 2 Data Ports	Q, T	EUE2-PFOW-4020	1754.03							
4 Power Receptacles, 1 Smart USB-A+C Charging, 1 Data Port	Q, T	EUE2-PFOW-4110	1864.80							
4 Power Receptacles, 2 Smart USB-A+C Charging	Q, T	EUE2-PFOW-4200	1975.57							
5 Power Receptacles, 1 Data Port	Q, T	EUE2-PFOW-5010	1754.03							
5 Power Receptacles, 1 Smart USB-A+C Charging	Q, T	EUE2-PFOW-5100	1864.80							
6 Power Receptacles	Q, T	EUE2-PFOW-6000	1754.03							

Worksurface Power Modules — Flip Top

Corded — Double-Sided

Bezel Depth	Bezel Width	Cord Length	Trim Color	Port Color	Port	Port Configuration	Cutout	Number	Price	
							Code			
							Options			
8" (203mm)	5.31" (135mm)	12' (3658mm)	Black Anodized	Black	4	1 Power Receptacle, 1 Data Port, 1 Cable Bay	M, P	EUE2-PLOB-1012	\$ 2144.14	
						1 Power Receptacle, 3 Data Ports	M, P	EUE2-PLOB-1030	2144.14	
						1 Power Receptacle, 1 Smart USB-A+C Charging, 1 Cable Bay	M, P	EUE2-PLOB-1102	2254.91	
						1 Power Receptacle, 1 Smart USB-A+C Charging, 2 Data Ports	M, P	EUE2-PLOB-1120	2254.91	
						1 Power Receptacle, 3 Smart USB-A+C Charging	M, P	EUE2-PLOB-1300	2476.45	
						2 Power Receptacles, 1 Cable Bay	M, P	EUE2-PLOB-2002	2144.14	
						2 Power Receptacles, 2 Data Ports	M, P	EUE2-PLOB-2020	2144.14	
						2 Power Receptacles, 1 Smart USB-A+C Charging, 1 Data Port	M, P	EUE2-PLOB-2110	2254.91	
						2 Power Receptacles, 2 Smart USB-A+C Charging	M, P	EUE2-PLOB-2200	2365.68	
						3 Power Receptacles, 1 Data Port	M, P	EUE2-PLOB-3010	2144.14	
						3 Power Receptacles, 1 Smart USB-A+C Charging	M, P	EUE2-PLOB-3100	2254.91	
						4 Power Receptacles	M, P	EUE2-PLOB-4000	2144.14	
						6	1 Power Receptacle, 3 Data Ports, 1 Cable Bay	Q, T	EUE2-PLOB-1032	\$ 2144.14
						1 Power Receptacle, 5 Data Ports	Q, T	EUE2-PLOB-1050	2144.14	
						1 Power Receptacle, 1 Smart USB-A+C Charging, 2 Data Ports, 1 Cable Bay	Q, T	EUE2-PLOB-1122	2254.91	
						1 Power Receptacle, 1 Smart USB-A+C Charging, 4 Data Ports	Q, T	EUE2-PLOB-1140	2254.91	
						1 Power Receptacle, 2 Smart USB-A+C Charging, 1 Data Port, 1 Cable Bay	Q, T	EUE2-PLOB-1212	2365.68	
						1 Power Receptacle, 2 Smart USB-A+C Charging, 3 Data Ports	Q, T	EUE2-PLOB-1230	2365.68	
						1 Power Receptacle, 3 Smart USB-A+C Charging, 1 Cable Bay	Q, T	EUE2-PLOB-1302	2476.45	
						1 Power Receptacle, 3 Smart USB-A+C Charging, 2 Data Ports	Q, T	EUE2-PLOB-1320	2476.45	
						2 Power Receptacles, 2 Data Ports, 1 Cable Bay	Q, T	EUE2-PLOB-2022	2144.14	
						2 Power Receptacles, 4 Data Ports	Q, T	EUE2-PLOB-2040	2144.14	
						2 Power Receptacles, 1 Smart USB-A+C Charging, 1 Data Port, 1 Cable Bay	Q, T	EUE2-PLOB-2112	2254.91	
						2 Power Receptacles, 1 Smart USB-A+C Charging, 3 Data Ports	Q, T	EUE2-PLOB-2130	2254.91	
						2 Power Receptacles, 2 Smart USB-A+C Charging, 1 Cable Bay	Q, T	EUE2-PLOB-2202	2365.68	
						2 Power Receptacles, 2 Smart USB-A+C Charging, 2 Data Ports	Q, T	EUE2-PLOB-2220	2365.68	
						2 Power Receptacles, 3 Smart USB-A+C Charging, 1 Data Port	Q, T	EUE2-PLOB-2310	2476.45	
						2 Power Receptacles, 4 Smart USB-A+C Charging	Q, T	EUE2-PLOB-2400	2587.22	
						3 Power Receptacles, 1 Data Port, 1 Cable Bay	Q, T	EUE2-PLOB-3012	2144.14	
						3 Power Receptacles, 3 Data Ports	Q, T	EUE2-PLOB-3030	2144.14	
						3 Power Receptacles, 1 Smart USB-A+C Charging, 1 Cable Bay	Q, T	EUE2-PLOB-3102	2254.91	
						3 Power Receptacles, 1 Smart USB-A+C Charging, 2 Data Ports	Q, T	EUE2-PLOB-3120	2254.91	
						3 Power Receptacles, 2 Smart USB-A+C Charging, 1 Data Port	Q, T	EUE2-PLOB-3210	2365.68	
						3 Power Receptacles, 3 Smart USB-A+C Charging	Q, T	EUE2-PLOB-3300	2476.45	
						4 Power Receptacles, 1 Cable Bay	Q, T	EUE2-PLOB-4002	2144.14	
						4 Power Receptacles, 2 Data Ports	Q, T	EUE2-PLOB-4020	2144.14	
						4 Power Receptacles, 1 Smart USB-A+C Charging, 1 Data Port	Q, T	EUE2-PLOB-4110	2254.91	
						4 Power Receptacles, 2 Smart USB-A+C Charging	Q, T	EUE2-PLOB-4200	2365.68	
						5 Power Receptacles, 1 Data Port	Q, T	EUE2-PLOB-5010	2144.14	
						5 Power Receptacles, 1 Smart USB-A+C Charging	Q, T	EUE2-PLOB-5100	2254.91	
6 Power Receptacles	Q, T	EUE2-PLOB-6000	2144.14							

Worksurface Power Modules — Flip Top

Corded — Double-Sided

Bezel Depth	Bezel Width	Cord Length	Trim Color	Port Color	Port	Port Configuration	Cutout	Number	Price	
							Code			Options
8" (203mm)	5.31" (135mm)	12' (3658mm)	Clear Anodized	White	4	1 Power Receptacle, 1 Data Port, 1 Cable Bay	M, P	EUE2-PLOW-1012	\$ 1844.55	
						1 Power Receptacle, 3 Data Ports	M, P	EUE2-PLOW-1030	1844.55	
						1 Power Receptacle, 1 Smart USB-A+C Charging, 1 Cable Bay	M, P	EUE2-PLOW-1102	1955.32	
						1 Power Receptacle, 1 Smart USB-A+C Charging, 2 Data Ports	M, P	EUE2-PLOW-1120	1955.32	
						1 Power Receptacle, 3 Smart USB-A+C Charging	M, P	EUE2-PLOW-1300	2176.86	
						2 Power Receptacles, 1 Cable Bay	M, P	EUE2-PLOW-2002	1844.55	
						2 Power Receptacles, 2 Data Ports	M, P	EUE2-PLOW-2020	1844.55	
						2 Power Receptacles, 1 Smart USB-A+C Charging, 1 Data Port	M, P	EUE2-PLOW-2110	1955.32	
						2 Power Receptacles, 2 Smart USB-A+C Charging	M, P	EUE2-PLOW-2200	2066.09	
						3 Power Receptacles, 1 Data Port	M, P	EUE2-PLOW-3010	1844.55	
						3 Power Receptacles, 1 Smart USB-A+C Charging	M, P	EUE2-PLOW-3100	1955.32	
						4 Power Receptacles	M, P	EUE2-PLOW-4000	1844.55	
						6	1 Power Receptacle, 3 Data Ports, 1 Cable Bay	Q, T	EUE2-PLOW-1032	\$ 1844.55
							1 Power Receptacle, 5 Data Ports	Q, T	EUE2-PLOW-1050	1844.55
							1 Power Receptacle, 1 Smart USB-A+C Charging, 2 Data Ports, 1 Cable Bay	Q, T	EUE2-PLOW-1122	1955.32
							1 Power Receptacle, 1 Smart USB-A+C Charging, 4 Data Ports	Q, T	EUE2-PLOW-1140	1955.32
					1 Power Receptacle, 2 Smart USB-A+C Charging, 1 Data Port, 1 Cable Bay		Q, T	EUE2-PLOW-1212	2066.09	
					1 Power Receptacle, 2 Smart USB-A+C Charging, 3 Data Ports		Q, T	EUE2-PLOW-1230	2066.09	
					1 Power Receptacle, 3 Smart USB-A+C Charging, 1 Cable Bay		Q, T	EUE2-PLOW-1302	2176.86	
					1 Power Receptacle, 3 Smart USB-A+C Charging, 2 Data Ports		Q, T	EUE2-PLOW-1320	2176.86	
					2 Power Receptacles, 2 Data Ports, 1 Cable Bay		Q, T	EUE2-PLOW-2022	1844.55	
					2 Power Receptacles, 4 Data Ports		Q, T	EUE2-PLOW-2040	1844.55	
					2 Power Receptacles, 1 Smart USB-A+C Charging, 1 Data Port, 1 Cable Bay		Q, T	EUE2-PLOW-2112	1955.32	
					2 Power Receptacles, 1 Smart USB-A+C Charging, 3 Data Ports		Q, T	EUE2-PLOW-2130	1955.32	
					2 Power Receptacles, 2 Smart USB-A+C Charging, 1 Cable Bay		Q, T	EUE2-PLOW-2202	2066.09	
					2 Power Receptacles, 2 Smart USB-A+C Charging, 2 Data Ports		Q, T	EUE2-PLOW-2220	2066.09	
					2 Power Receptacles, 3 Smart USB-A+C Charging, 1 Data Port		Q, T	EUE2-PLOW-2310	2176.86	
					2 Power Receptacles, 4 Smart USB-A+C Charging		Q, T	EUE2-PLOW-2400	2287.63	
					3 Power Receptacles, 1 Data Port, 1 Cable Bay	Q, T	EUE2-PLOW-3012	1844.55		
					3 Power Receptacles, 3 Data Ports	Q, T	EUE2-PLOW-3030	1844.55		
					3 Power Receptacles, 1 Smart USB-A+C Charging, 1 Cable Bay	Q, T	EUE2-PLOW-3102	1955.32		
					3 Power Receptacles, 1 Smart USB-A+C Charging, 2 Data Ports	Q, T	EUE2-PLOW-3120	1955.32		
3 Power Receptacles, 2 Smart USB-A+C Charging, 1 Data Port	Q, T	EUE2-PLOW-3210	2066.09							
3 Power Receptacles, 3 Smart USB-A+C Charging	Q, T	EUE2-PLOW-3300	2176.86							
4 Power Receptacles, 1 Cable Bay	Q, T	EUE2-PLOW-4002	1844.55							
4 Power Receptacles, 2 Data Ports	Q, T	EUE2-PLOW-4020	1844.55							
4 Power Receptacles, 1 Smart USB-A+C Charging, 1 Data Port	Q, T	EUE2-PLOW-4110	1955.32							
4 Power Receptacles, 2 Smart USB-A+C Charging	Q, T	EUE2-PLOW-4200	2066.09							
5 Power Receptacles, 1 Data Port	Q, T	EUE2-PLOW-5010	1844.55							
5 Power Receptacles, 1 Smart USB-A+C Charging	Q, T	EUE2-PLOW-5100	1955.32							
6 Power Receptacles	Q, T	EUE2-PLOW-6000	1844.55							

Worksurface Power Modules — Flip Top

Hardwire — Single-Sided

Power, Data and USB

4-Port:

- (2) Power
- (1) Smart USB-A+C
- (1) Data

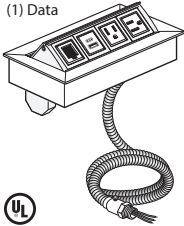

Hard Wired

EUEI-HFOB-2110

6-Port:

- (3) Power
- (1) Smart USB-A+C
- (2) Data

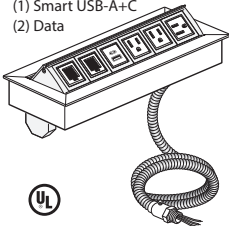

Hard Wired

EUEI-HFOB-1212

Class YA

Features

- Includes bezel and flip top module with 2, 4 or 6 ports that can be configured with simplex outlets (NEMA-5-15R), USB charging port (Smart USB-A+C), data ports or cable bay(s) that can accept up to 2 pull out data/AV cables and mounting hardware.
- Data port accommodate most varieties of field supplied data/ AV jacks.
- Hardwired power module with 6'(1829mm) or 12'(3658mm) long flexible metal conduit feed, 0.5"(13mm) conduit fitting and wires for hardwire connection.
- The Smart USB-A+C allows for the 20W to be transferred between the 2 ports. If the USB-A is being used, the full wattage is sent to the USB-A, and the same for the USB-C. If both are being used, the wattage is distributed to each port and the port drawing the most power will receive more watts than the one that is not.
- Flip top unit is flush mounted with spring release flip module(s).
- Flip top unit overall height is 2.75"(70mm) and will extend below the table tops.
- Color option of black anodized housing with black receptacles or clear anodized housing with white receptacles.

Specification Tips

- Designed to be used with 1.18"(30 mm) and 2"(51mm) thick surfaces with clear space below.
- **Configuration and quantity of power and data ports cannot be modified in the field.**
- **For use with 120 volt 60 hertz power source only.**
- Requires field installation.
- Specify factory cut hole or field cut hole as required.
- Specify AV cables separately.
- Cable Bay requires cables less than 0.3"(8mm) diameter.
- Application may require approval of local authority having jurisdiction (AHJ); ensure compliance before placing orders and installation.

To Order, Specify:

- 1) Product number.
(No finish specification required.)

Note: Order flip top units to match flip top unit cutout option specified for each top (A/B, F/V or J/K).

Worksurface Power Modules — Flip Top

Hardwire — Single-Sided

Bezel Depth	Bezel Width	Cord Length	Trim Color	Port Color	Port	Port Configuration	Cutout	Number	Price	
							Code Options			
4.37" (111mm)	5.31" (135mm)	6' (1829mm)	Black Anodized	Black	2	1 Power Receptacle, 1 Data Port	A, B	EUE1-HFOB-1010	\$1302.79	
						1 Power Receptacle, 1 Smart USB-A+C Charging	A, B	EUE1-HFOB-1100	1413.56	
						2 Power Receptacles	A, B	EUE1-HFOB-2000	1302.79	
						4	1 Power Receptacle, 1 Data Port, 1 Cable Bay	F, V	EUE1-HFOB-1012	\$1302.79
							1 Power Receptacle, 3 Data Ports	F, V	EUE1-HFOB-1030	1302.79
							1 Power Receptacle, 1 Smart USB-A+C Charging, 1 Cable Bay	F, V	EUE1-HFOB-1102	1413.56
							1 Power Receptacle, 1 Smart USB-A+C Charging, 2 Data Ports	F, V	EUE1-HFOB-1120	1413.56
							1 Power Receptacle, 3 Smart USB-A+C Charging	F, V	EUE1-HFOB-1300	1635.10
							2 Power Receptacles, 1 Cable Bay	F, V	EUE1-HFOB-2002	1302.79
							2 Power Receptacles, 2 Data Ports	F, V	EUE1-HFOB-2020	1302.79
							2 Power Receptacles, 1 Smart USB-A+C Charging, 1 Data Port	F, V	EUE1-HFOB-2110	1413.56
							2 Power Receptacles, 2 Smart USB-A+C Charging	F, V	EUE1-HFOB-2200	1524.33
							3 Power Receptacles, 1 Data Port	F, V	EUE1-HFOB-3010	1302.79
							3 Power Receptacles, 1 Smart USB-A+C Charging	F, V	EUE1-HFOB-3100	1413.56
							4 Power Receptacles	F, V	EUE1-HFOB-4000	1302.79
						6	1 Power Receptacle, 3 Data Ports, 1 Cable Bay	J, K	EUE1-HFOB-1032	\$1302.79
							1 Power Receptacle, 5 Data Ports	J, K	EUE1-HFOB-1050	1302.79
							1 Power Receptacle, 1 Smart USB-A+C Charging, 2 Data Ports, 1 Cable Bay	J, K	EUE1-HFOB-1122	1413.56
							1 Power Receptacle, 1 Smart USB-A+C Charging, 4 Data Ports	J, K	EUE1-HFOB-1140	1413.56
							1 Power Receptacle, 2 Smart USB-A+C Charging, 1 Data Port, 1 Cable Bay	J, K	EUE1-HFOB-1212	1524.33
							1 Power Receptacle, 2 Smart USB-A+C Charging, 3 Data Ports	J, K	EUE1-HFOB-1230	1524.33
							1 Power Receptacle, 3 Smart USB-A+C Charging, 1 Cable Bay	J, K	EUE1-HFOB-1302	1635.10
							1 Power Receptacle, 3 Smart USB-A+C Charging, 2 Data Ports	J, K	EUE1-HFOB-1320	1635.10
							2 Power Receptacles, 2 Data Ports, 1 Cable Bay	J, K	EUE1-HFOB-2022	1302.79
					2 Power Receptacles, 4 Data Ports		J, K	EUE1-HFOB-2040	1302.79	
					2 Power Receptacles, 1 Smart USB-A+C Charging, 1 Data Port, 1 Cable Bay		J, K	EUE1-HFOB-2112	1413.56	
					2 Power Receptacles, 1 Smart USB-A+C Charging, 3 Data Ports		J, K	EUE1-HFOB-2130	1413.56	
					2 Power Receptacles, 2 Smart USB-A+C Charging, 1 Cable Bay		J, K	EUE1-HFOB-2202	1524.33	
					2 Power Receptacles, 2 Smart USB-A+C Charging, 2 Data Ports		J, K	EUE1-HFOB-2220	1524.33	
					2 Power Receptacles, 3 Smart USB-A+C Charging, 1 Data Port		J, K	EUE1-HFOB-2310	1635.10	
					2 Power Receptacles, 4 Smart USB-A+C Charging		J, K	EUE1-HFOB-2400	1745.87	
					3 Power Receptacles, 1 Data Port, 1 Cable Bay		J, K	EUE1-HFOB-3012	1302.79	
					3 Power Receptacles, 3 Data Ports		J, K	EUE1-HFOB-3030	1302.79	
					3 Power Receptacles, 1 Smart USB-A+C Charging, 1 Cable Bay		J, K	EUE1-HFOB-3102	1413.56	
					3 Power Receptacles, 1 Smart USB-A+C Charging, 2 Data Ports		J, K	EUE1-HFOB-3120	1413.56	
					3 Power Receptacles, 2 Smart USB-A+C Charging, 1 Data Port		J, K	EUE1-HFOB-3210	1524.33	
					3 Power Receptacles, 3 Smart USB-A+C Charging		J, K	EUE1-HFOB-3300	1635.10	
					4 Power Receptacles, 1 Cable Bay		J, K	EUE1-HFOB-4002	1302.79	
					4 Power Receptacles, 2 Data Ports		J, K	EUE1-HFOB-4020	1302.79	
					4 Power Receptacles, 1 Smart USB-A+C Charging, 1 Data Port	J, K	EUE1-HFOB-4110	1413.56		
					4 Power Receptacles, 2 Smart USB-A+C Charging	J, K	EUE1-HFOB-4200	1524.33		
					5 Power Receptacles, 1 Data Port	J, K	EUE1-HFOB-5010	1302.79		
					5 Power Receptacles, 1 Smart USB-A+C Charging	J, K	EUE1-HFOB-5100	1413.56		
					6 Power Receptacles	J, K	EUE1-HFOB-6000	1302.79		

Worksurface Power Modules — Flip Top

Hardwire — Single-Sided

Bezel Depth	Bezel Width	Cord Length	Trim Color	Port Color	Port	Port Configuration	Cutout		Price	
							Code	Options Number		
4.37" (111mm)	5.31" (135mm)	6' (1829mm)	Clear Anodized	White	2	1 Power Receptacle, 1 Data Port	A, B	EUE1-HFOW-1010	\$1003.20	
						1 Power Receptacle, 1 Smart USB-A+C Charging	A, B	EUE1-HFOW-1100	1113.97	
						2 Power Receptacles	A, B	EUE1-HFOW-2000	1003.20	
						4	1 Power Receptacle, 1 Data Port, 1 Cable Bay	F, V	EUE1-HFOW-1012	\$1003.20
							1 Power Receptacle, 3 Data Ports	F, V	EUE1-HFOW-1030	1003.20
							1 Power Receptacle, 1 Smart USB-A+C Charging, 1 Cable Bay	F, V	EUE1-HFOW-1102	1113.97
							1 Power Receptacle, 1 Smart USB-A+C Charging, 2 Data Ports	F, V	EUE1-HFOW-1120	1113.97
							1 Power Receptacle, 3 Smart USB-A+C Charging	F, V	EUE1-HFOW-1300	1335.51
							2 Power Receptacles, 1 Cable Bay	F, V	EUE1-HFOW-2002	1003.20
							2 Power Receptacles, 2 Data Ports	F, V	EUE1-HFOW-2020	1003.20
							2 Power Receptacles, 1 Smart USB-A+C Charging, 1 Data Port	F, V	EUE1-HFOW-2110	1113.97
							2 Power Receptacles, 2 Smart USB-A+C Charging	F, V	EUE1-HFOW-2200	1224.74
							3 Power Receptacles, 1 Data Port	F, V	EUE1-HFOW-3010	1003.20
							3 Power Receptacles, 1 Smart USB-A+C Charging	F, V	EUE1-HFOW-3100	1113.97
							4 Power Receptacles	F, V	EUE1-HFOW-4000	1003.20
						6	1 Power Receptacle, 3 Data Ports, 1 Cable Bay	J, K	EUE1-HFOW-1032	\$1003.20
							1 Power Receptacle, 5 Data Ports	J, K	EUE1-HFOW-1050	1003.20
							1 Power Receptacle, 1 Smart USB-A+C Charging, 2 Data Ports, 1 Cable Bay	J, K	EUE1-HFOW-1122	1113.97
							1 Power Receptacle, 1 Smart USB-A+C Charging, 4 Data Ports	J, K	EUE1-HFOW-1140	1113.97
							1 Power Receptacle, 2 Smart USB-A+C Charging, 1 Data Port, 1 Cable Bay	J, K	EUE1-HFOW-1212	1224.74
							1 Power Receptacle, 2 Smart USB-A+C Charging, 3 Data Ports	J, K	EUE1-HFOW-1230	1224.74
							1 Power Receptacle, 3 Smart USB-A+C Charging, 1 Cable Bay	J, K	EUE1-HFOW-1302	1335.51
							1 Power Receptacle, 3 Smart USB-A+C Charging, 2 Data Ports	J, K	EUE1-HFOW-1320	1335.51
							2 Power Receptacles, 2 Data Ports, 1 Cable Bay	J, K	EUE1-HFOW-2022	1003.20
							2 Power Receptacles, 4 Data Ports	J, K	EUE1-HFOW-2040	1003.20
							2 Power Receptacles, 1 Smart USB-A+C Charging, 1 Data Port, 1 Cable Bay	J, K	EUE1-HFOW-2112	1113.97
							2 Power Receptacles, 1 Smart USB-A+C Charging, 3 Data Ports	J, K	EUE1-HFOW-2130	1113.97
							2 Power Receptacles, 2 Smart USB-A+C Charging, 1 Cable Bay	J, K	EUE1-HFOW-2202	1224.74
							2 Power Receptacles, 2 Smart USB-A+C Charging, 2 Data Ports	J, K	EUE1-HFOW-2220	1224.74
							2 Power Receptacles, 3 Smart USB-A+C Charging, 1 Data Port	J, K	EUE1-HFOW-2310	1335.51
2 Power Receptacles, 4 Smart USB-A+C Charging	J, K	EUE1-HFOW-2400	1446.28							
3 Power Receptacles, 1 Data Port, 1 Cable Bay	J, K	EUE1-HFOW-3012	1003.20							
3 Power Receptacles, 3 Data Ports	J, K	EUE1-HFOW-3030	1003.20							
3 Power Receptacles, 1 Smart USB-A+C Charging, 1 Cable Bay	J, K	EUE1-HFOW-3102	1113.97							
3 Power Receptacles, 1 Smart USB-A+C Charging, 2 Data Ports	J, K	EUE1-HFOW-3120	1113.97							
3 Power Receptacles, 2 Smart USB-A+C Charging, 1 Data Port	J, K	EUE1-HFOW-3210	1224.74							
3 Power Receptacles, 3 Smart USB-A+C Charging	J, K	EUE1-HFOW-3300	1335.51							
4 Power Receptacles, 1 Cable Bay	J, K	EUE1-HFOW-4002	1003.20							
4 Power Receptacles, 2 Data Ports	J, K	EUE1-HFOW-4020	1003.20							
4 Power Receptacles, 1 Smart USB-A+C Charging, 1 Data Port	J, K	EUE1-HFOW-4110	1113.97							
4 Power Receptacles, 2 Smart USB-A+C Charging	J, K	EUE1-HFOW-4200	1224.74							
5 Power Receptacles, 1 Data Port	J, K	EUE1-HFOW-5010	1003.20							
5 Power Receptacles, 1 Smart USB-A+C Charging	J, K	EUE1-HFOW-5100	1113.97							
6 Power Receptacles	J, K	EUE1-HFOW-6000	1003.20							

Worksurface Power Modules — Flip Top

Hardwire — Single-Sided

Bezel Depth	Bezel Width	Cord Length	Trim Color	Port Color	Port	Port Configuration	Cutout		Price		
							Code	Options Number			
4.37" (111mm)	5.31" (135mm)	12' (3658mm)	Black Anodized	Black	2	1 Power Receptacle, 1 Data Port	A, B	EUE1-HLOB-1010	\$1393.31		
						1 Power Receptacle, 1 Smart USB-A+C Charging	A, B	EUE1-HLOB-1100	1504.08		
						2 Power Receptacles	A, B	EUE1-HLOB-2000	1393.31		
						4	1 Power Receptacle, 1 Data Port, 1 Cable Bay	F, V	EUE1-HLOB-1012	\$1393.31	
							1 Power Receptacle, 3 Data Ports	F, V	EUE1-HLOB-1030	1393.31	
							1 Power Receptacle, 1 Smart USB-A+C Charging, 1 Cable Bay	F, V	EUE1-HLOB-1102	1504.08	
							1 Power Receptacle, 1 Smart USB-A+C Charging, 2 Data Ports	F, V	EUE1-HLOB-1120	1504.08	
							1 Power Receptacle, 3 Smart USB-A+C Charging	F, V	EUE1-HLOB-1300	1725.62	
							2 Power Receptacles, 1 Cable Bay	F, V	EUE1-HLOB-2002	1393.31	
							2 Power Receptacles, 2 Data Ports	F, V	EUE1-HLOB-2020	1393.31	
							2 Power Receptacles, 1 Smart USB-A+C Charging, 1 Data Port	F, V	EUE1-HLOB-2110	1504.08	
							2 Power Receptacles, 2 Smart USB-A+C Charging	F, V	EUE1-HLOB-2200	1614.85	
							3 Power Receptacles, 1 Data Port	F, V	EUE1-HLOB-3010	1393.31	
							3 Power Receptacles, 1 Smart USB-A+C Charging	F, V	EUE1-HLOB-3100	1504.08	
							4 Power Receptacles	F, V	EUE1-HLOB-4000	1393.31	
							6	1 Power Receptacle, 3 Data Ports, 1 Cable Bay	J, K	EUE1-HLOB-1032	\$1393.31
								1 Power Receptacle, 5 Data Ports	J, K	EUE1-HLOB-1050	1393.31
								1 Power Receptacle, 1 Smart USB-A+C Charging, 2 Data Ports, 1 Cable Bay	J, K	EUE1-HLOB-1122	1504.08
						1 Power Receptacle, 1 Smart USB-A+C Charging, 4 Data Ports		J, K	EUE1-HLOB-1140	1504.08	
						1 Power Receptacle, 2 Smart USB-A+C Charging, 1 Data Port, 1 Cable Bay		J, K	EUE1-HLOB-1212	1614.85	
						1 Power Receptacle, 2 Smart USB-A+C Charging, 3 Data Ports		J, K	EUE1-HLOB-1230	1614.85	
						1 Power Receptacle, 3 Smart USB-A+C Charging, 1 Cable Bay		J, K	EUE1-HLOB-1302	1725.62	
						1 Power Receptacle, 3 Smart USB-A+C Charging, 2 Data Ports		J, K	EUE1-HLOB-1320	1725.62	
						2 Power Receptacles, 2 Data Ports, 1 Cable Bay		J, K	EUE1-HLOB-2022	1393.31	
						2 Power Receptacles, 4 Data Ports		J, K	EUE1-HLOB-2040	1393.31	
						2 Power Receptacles, 1 Smart USB-A+C Charging, 1 Data Port, 1 Cable Bay		J, K	EUE1-HLOB-2112	1504.08	
						2 Power Receptacles, 1 Smart USB-A+C Charging, 3 Data Ports		J, K	EUE1-HLOB-2130	1504.08	
						2 Power Receptacles, 2 Smart USB-A+C Charging, 1 Cable Bay		J, K	EUE1-HLOB-2202	1614.85	
						2 Power Receptacles, 2 Smart USB-A+C Charging, 2 Data Ports		J, K	EUE1-HLOB-2220	1614.85	
						2 Power Receptacles, 3 Smart USB-A+C Charging, 1 Data Port		J, K	EUE1-HLOB-2310	1725.62	
						2 Power Receptacles, 4 Smart USB-A+C Charging		J, K	EUE1-HLOB-2400	1836.39	
						3 Power Receptacles, 1 Data Port, 1 Cable Bay		J, K	EUE1-HLOB-3012	1393.31	
						3 Power Receptacles, 3 Data Ports		J, K	EUE1-HLOB-3030	1393.31	
3 Power Receptacles, 1 Smart USB-A+C Charging, 1 Cable Bay	J, K	EUE1-HLOB-3102	1504.08								
3 Power Receptacles, 1 Smart USB-A+C Charging, 2 Data Ports	J, K	EUE1-HLOB-3120	1504.08								
3 Power Receptacles, 2 Smart USB-A+C Charging, 1 Data Port	J, K	EUE1-HLOB-3210	1614.85								
3 Power Receptacles, 3 Smart USB-A+C Charging	J, K	EUE1-HLOB-3300	1725.62								
4 Power Receptacles, 1 Cable Bay	J, K	EUE1-HLOB-4002	1393.31								
4 Power Receptacles, 2 Data Ports	J, K	EUE1-HLOB-4020	1393.31								
4 Power Receptacles, 1 Smart USB-A+C Charging, 1 Data Port	J, K	EUE1-HLOB-4110	1504.08								
4 Power Receptacles, 2 Smart USB-A+C Charging	J, K	EUE1-HLOB-4200	1614.85								
5 Power Receptacles, 1 Data Port	J, K	EUE1-HLOB-5010	1393.31								
5 Power Receptacles, 1 Smart USB-A+C Charging	J, K	EUE1-HLOB-5100	1504.08								
6 Power Receptacles	J, K	EUE1-HLOB-6000	1393.31								

Worksurface Power Modules — Flip Top

Hardwire — Single-Sided

Bezel Depth	Bezel Width	Cord Length	Trim Color	Port Color	Port	Port Configuration	Cutout	Number	Price	
							Code Options			
4.37" (111mm)	5.31" (135mm)	12' (3658mm)	Clear Anodized	White	2	1 Power Receptacle, 1 Data Port	A, B	EUE1-HLOW-1010	\$1093.72	
						1 Power Receptacle, 1 Smart USB-A+C Charging	A, B	EUE1-HLOW-1100	1204.49	
						2 Power Receptacles	A, B	EUE1-HLOW-2000	1093.72	
						4	1 Power Receptacle, 1 Data Port, 1 Cable Bay	F, V	EUE1-HLOW-1012	\$1093.72
							1 Power Receptacle, 3 Data Ports	F, V	EUE1-HLOW-1030	1093.72
							1 Power Receptacle, 1 Smart USB-A+C Charging, 1 Cable Bay	F, V	EUE1-HLOW-1102	1204.49
							1 Power Receptacle, 1 Smart USB-A+C Charging, 2 Data Ports	F, V	EUE1-HLOW-1120	1204.49
							1 Power Receptacle, 3 Smart USB-A+C Charging	F, V	EUE1-HLOW-1300	1426.03
							2 Power Receptacles, 1 Cable Bay	F, V	EUE1-HLOW-2002	1093.72
							2 Power Receptacles, 2 Data Ports	F, V	EUE1-HLOW-2020	1093.72
							2 Power Receptacles, 1 Smart USB-A+C Charging, 1 Data Port	F, V	EUE1-HLOW-2110	1204.49
							2 Power Receptacles, 2 Smart USB-A+C Charging	F, V	EUE1-HLOW-2200	1315.26
							3 Power Receptacles, 1 Data Port	F, V	EUE1-HLOW-3010	1093.72
							3 Power Receptacles, 1 Smart USB-A+C Charging	F, V	EUE1-HLOW-3100	1204.49
							4 Power Receptacles	F, V	EUE1-HLOW-4000	1093.72
						6	1 Power Receptacle, 3 Data Ports, 1 Cable Bay	J, K	EUE1-HLOW-1032	\$1093.72
							1 Power Receptacle, 5 Data Ports	J, K	EUE1-HLOW-1050	1093.72
							1 Power Receptacle, 1 Smart USB-A+C Charging, 2 Data Ports, 1 Cable Bay	J, K	EUE1-HLOW-1122	1204.49
							1 Power Receptacle, 1 Smart USB-A+C Charging, 4 Data Ports	J, K	EUE1-HLOW-1140	1204.49
							1 Power Receptacle, 2 Smart USB-A+C Charging, 1 Data Port, 1 Cable Bay	J, K	EUE1-HLOW-1212	1315.26
							1 Power Receptacle, 2 Smart USB-A+C Charging, 3 Data Ports	J, K	EUE1-HLOW-1230	1315.26
							1 Power Receptacle, 3 Smart USB-A+C Charging, 1 Cable Bay	J, K	EUE1-HLOW-1302	1426.03
							1 Power Receptacle, 3 Smart USB-A+C Charging, 2 Data Ports	J, K	EUE1-HLOW-1320	1426.03
							2 Power Receptacles, 2 Data Ports, 1 Cable Bay	J, K	EUE1-HLOW-2022	1093.72
							2 Power Receptacles, 4 Data Ports	J, K	EUE1-HLOW-2040	1093.72
							2 Power Receptacles, 1 Smart USB-A+C Charging, 1 Data Port, 1 Cable Bay	J, K	EUE1-HLOW-2112	1204.49
							2 Power Receptacles, 1 Smart USB-A+C Charging, 3 Data Ports	J, K	EUE1-HLOW-2130	1204.49
							2 Power Receptacles, 2 Smart USB-A+C Charging, 1 Cable Bay	J, K	EUE1-HLOW-2202	1315.26
							2 Power Receptacles, 2 Smart USB-A+C Charging, 2 Data Ports	J, K	EUE1-HLOW-2220	1315.26
							2 Power Receptacles, 3 Smart USB-A+C Charging, 1 Data Port	J, K	EUE1-HLOW-2310	1426.03
2 Power Receptacles, 4 Smart USB-A+C Charging	J, K	EUE1-HLOW-2400	1536.80							
3 Power Receptacles, 1 Data Port, 1 Cable Bay	J, K	EUE1-HLOW-3012	1093.72							
3 Power Receptacles, 3 Data Ports	J, K	EUE1-HLOW-3030	1093.72							
3 Power Receptacles, 1 Smart USB-A+C Charging, 1 Cable Bay	J, K	EUE1-HLOW-3102	1204.49							
3 Power Receptacles, 1 Smart USB-A+C Charging, 2 Data Ports	J, K	EUE1-HLOW-3120	1204.49							
3 Power Receptacles, 2 Smart USB-A+C Charging, 1 Data Port	J, K	EUE1-HLOW-3210	1315.26							
3 Power Receptacles, 3 Smart USB-A+C Charging	J, K	EUE1-HLOW-3300	1426.03							
4 Power Receptacles, 1 Cable Bay	J, K	EUE1-HLOW-4002	1093.72							
4 Power Receptacles, 2 Data Ports	J, K	EUE1-HLOW-4020	1093.72							
4 Power Receptacles, 1 Smart USB-A+C Charging, 1 Data Port	J, K	EUE1-HLOW-4110	1204.49							
4 Power Receptacles, 2 Smart USB-A+C Charging	J, K	EUE1-HLOW-4200	1315.26							
5 Power Receptacles, 1 Data Port	J, K	EUE1-HLOW-5010	1093.72							
5 Power Receptacles, 1 Smart USB-A+C Charging	J, K	EUE1-HLOW-5100	1204.49							
6 Power Receptacles	J, K	EUE1-HLOW-6000	1093.72							

Worksurface Power Modules — Flip Top

Hardwire — Double-Sided

Power, Data and USB

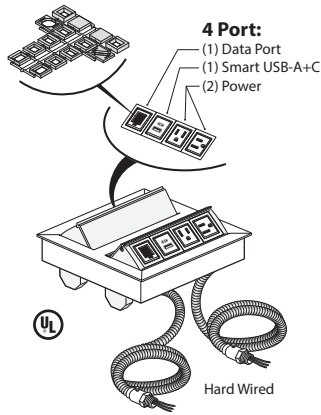

EUE2-HFOB-2110

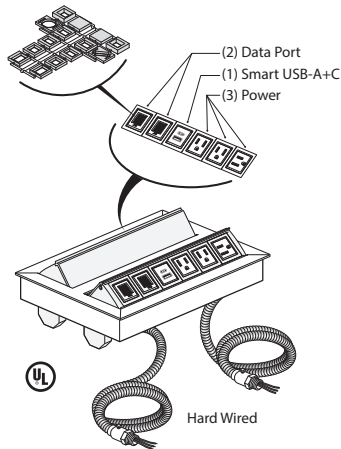

EUE2-HFOB-1212

Class YA

Features

- Includes bezel and two flip top modules, each with 2, 4 or 6 ports that can be configured with simplex outlets (NEMA-5-15R), USB charging port (Smart USB-A+C), data ports or cable bay(s) that can accept up to 2 pull out data/AV cables and mounting hardware.
- Data port accommodate most varieties of field supplied data/ AV jacks.
- Each flip top module within the bezel provided with 6'(1829mm) or 12'(3658mm) long flexible metal conduit feed, 0.5"(13mm) conduit fitting and wires for hardwire connection.
- The Smart USB-A+C allows for the 20W to be transferred between the 2 ports. If the USB-A is being used, the full wattage is sent to the USB-A, and the same for the USB-C. If both are being used, the wattage is distributed to each port and the port drawing the most power will receive more watts than the one that is not.
- Flip top frame is flush mounted with two spring release flip module(s).
- Flip top unit overall height is 2.75"(70mm) and will extend below the table tops.
- Color option of black anodized housing with black receptacles or clear anodized housing with white receptacles.
- Ships assembled.

Specification Tips

- Designed to be used with 1.18"(30mm) and 2"(51mm) thick surfaces with clear space below.
- **Configuration and quantity of power and data ports cannot be modified in the field.**
- **For use with 120 volt 60 hertz power source only.**
- Note two conduit feeds are provided from the double-sided flip top unit.
- Requires field installation.
- Specify factory cut hole or field cut hole as required.
- Specify AV cables separately.
- Cable Bay requires cables less than 0.3"(8mm) diameter.
- Application may require approval of local authority having jurisdiction (AHJ); ensure compliance before placing orders and installation.

To Order, Specify:

- 1) Product number.
(No finish specification required.)

Note: Order flip top units to match flip top unit cutout option specified for each top (M/P or Q/V).

Worksurface Power Modules — Flip Top

Hardwire — Double-Sided

Bezel Depth	Bezel Width	Cord Length	Trim Color	Port Color	Port	Port Configuration	Cutout	Number	Price	
							Code			
							Options			
8" (203mm)	5.31" (135mm)	6' (1829mm)	Black Anodized	Black	4	1 Power Receptacle, 1 Data Port, 1 Cable Bay	M, P	EUE2-HFOB-1012	\$2300.42	
						1 Power Receptacle, 3 Data Ports	M, P	EUE2-HFOB-1030	2300.42	
						1 Power Receptacle, 1 Smart USB-A+C Charging, 1 Cable Bay	M, P	EUE2-HFOB-1102	2411.19	
						1 Power Receptacle, 1 Smart USB-A+C Charging, 2 Data Ports	M, P	EUE2-HFOB-1120	2411.19	
						1 Power Receptacle, 3 Smart USB-A+C Charging	M, P	EUE2-HFOB-1300	2632.73	
						2 Power Receptacles, 1 Cable Bay	M, P	EUE2-HFOB-2002	2300.42	
						2 Power Receptacles, 2 Data Ports	M, P	EUE2-HFOB-2020	2300.42	
						2 Power Receptacles, 1 Smart USB-A+C Charging, 1 Data Port	M, P	EUE2-HFOB-2110	2411.19	
						2 Power Receptacles, 2 Smart USB-A+C Charging	M, P	EUE2-HFOB-2200	2521.96	
						3 Power Receptacles, 1 Data Port	M, P	EUE2-HFOB-3010	2300.42	
						3 Power Receptacles, 1 Smart USB-A+C Charging	M, P	EUE2-HFOB-3100	2411.19	
						4 Power Receptacles	M, P	EUE2-HFOB-4000	2300.42	
						6	1 Power Receptacle, 3 Data Ports, 1 Cable Bay	Q, V	EUE2-HFOB-1032	\$2300.42
							1 Power Receptacle, 5 Data Ports	Q, V	EUE2-HFOB-1050	2300.42
							1 Power Receptacle, 1 Smart USB-A+C Charging, 2 Data Ports, 1 Cable Bay	Q, V	EUE2-HFOB-1122	2411.19
							1 Power Receptacle, 1 Smart USB-A+C Charging, 4 Data Ports	Q, V	EUE2-HFOB-1140	2411.19
					1 Power Receptacle, 2 Smart USB-A+C Charging, 1 Data Port, 1 Cable Bay		Q, V	EUE2-HFOB-1212	2521.96	
					1 Power Receptacle, 2 Smart USB-A+C Charging, 3 Data Ports		Q, V	EUE2-HFOB-1230	2521.96	
					1 Power Receptacle, 3 Smart USB-A+C Charging, 1 Cable Bay		Q, V	EUE2-HFOB-1302	2632.73	
					1 Power Receptacle, 3 Smart USB-A+C Charging, 2 Data Ports		Q, V	EUE2-HFOB-1320	2632.73	
					2 Power Receptacles, 2 Data Ports, 1 Cable Bay		Q, V	EUE2-HFOB-2022	2300.42	
					2 Power Receptacles, 4 Data Ports		Q, V	EUE2-HFOB-2040	2300.42	
					2 Power Receptacles, 1 Smart USB-A+C Charging, 1 Data Port, 1 Cable Bay		Q, V	EUE2-HFOB-2112	2411.19	
					2 Power Receptacles, 1 Smart USB-A+C Charging, 3 Data Ports		Q, V	EUE2-HFOB-2130	2411.19	
					2 Power Receptacles, 2 Smart USB-A+C Charging, 1 Cable Bay		Q, V	EUE2-HFOB-2202	2521.96	
					2 Power Receptacles, 2 Smart USB-A+C Charging, 2 Data Ports		Q, V	EUE2-HFOB-2220	2521.96	
					2 Power Receptacles, 3 Smart USB-A+C Charging, 1 Data Port		Q, V	EUE2-HFOB-2310	2632.73	
					2 Power Receptacles, 4 Smart USB-A+C Charging		Q, V	EUE2-HFOB-2400	2743.50	
					3 Power Receptacles, 1 Data Port, 1 Cable Bay	Q, V	EUE2-HFOB-3012	2300.42		
					3 Power Receptacles, 3 Data Ports	Q, V	EUE2-HFOB-3030	2300.42		
					3 Power Receptacles, 1 Smart USB-A+C Charging, 1 Cable Bay	Q, V	EUE2-HFOB-3102	2411.19		
					3 Power Receptacles, 1 Smart USB-A+C Charging, 2 Data Ports	Q, V	EUE2-HFOB-3120	2411.19		
3 Power Receptacles, 2 Smart USB-A+C Charging, 1 Data Port	Q, V	EUE2-HFOB-3210	2521.96							
3 Power Receptacles, 3 Smart USB-A+C Charging	Q, V	EUE2-HFOB-3300	2632.73							
4 Power Receptacles, 1 Cable Bay	Q, V	EUE2-HFOB-4002	2300.42							
4 Power Receptacles, 2 Data Ports	Q, V	EUE2-HFOB-4020	2300.42							
4 Power Receptacles, 1 Smart USB-A+C Charging, 1 Data Port	Q, V	EUE2-HFOB-4110	2411.19							
4 Power Receptacles, 2 Smart USB-A+C Charging	Q, V	EUE2-HFOB-4200	2521.96							
5 Power Receptacles, 1 Data Port	Q, V	EUE2-HFOB-5010	2300.42							
5 Power Receptacles, 1 Smart USB-A+C Charging	Q, V	EUE2-HFOB-5100	2411.19							
6 Power Receptacles	Q, V	EUE2-HFOB-6000	2300.42							

Worksurface Power Modules — Flip Top

Hardwire — Double-Sided

Bezel Depth	Bezel Width	Cord Length	Trim Color	Port Color	Port	Port Configuration	Cutout	Number	Price	
							Code			
							Options			
8" (203mm)	5.31" (135mm)	6' (1829mm)	Clear Anodized	White	4	1 Power Receptacle, 1 Data Port, 1 Cable Bay	M, P	EUE2-HFOW-1012	\$2000.83	
						1 Power Receptacle, 3 Data Ports	M, P	EUE2-HFOW-1030	2000.83	
						1 Power Receptacle, 1 Smart USB-A+C Charging, 1 Cable Bay	M, P	EUE2-HFOW-1102	2111.60	
						1 Power Receptacle, 1 Smart USB-A+C Charging, 2 Data Ports	M, P	EUE2-HFOW-1120	2111.60	
						1 Power Receptacle, 3 Smart USB-A+C Charging	M, P	EUE2-HFOW-1300	2333.14	
						2 Power Receptacles, 1 Cable Bay	M, P	EUE2-HFOW-2002	2000.83	
						2 Power Receptacles, 2 Data Ports	M, P	EUE2-HFOW-2020	2000.83	
						2 Power Receptacles, 1 Smart USB-A+C Charging, 1 Data Port	M, P	EUE2-HFOW-2110	2111.60	
						2 Power Receptacles, 2 Smart USB-A+C Charging	M, P	EUE2-HFOW-2200	2222.37	
						3 Power Receptacles, 1 Data Port	M, P	EUE2-HFOW-3010	2000.83	
						3 Power Receptacles, 1 Smart USB-A+C Charging	M, P	EUE2-HFOW-3100	2111.60	
						4 Power Receptacles	M, P	EUE2-HFOW-4000	2000.83	
						6	1 Power Receptacle, 3 Data Ports, 1 Cable Bay	Q, V	EUE2-HFOW-1032	\$2000.83
							1 Power Receptacle, 5 Data Ports	Q, V	EUE2-HFOW-1050	2000.83
							1 Power Receptacle, 1 Smart USB-A+C Charging, 2 Data Ports, 1 Cable Bay	Q, V	EUE2-HFOW-1122	2111.60
							1 Power Receptacle, 1 Smart USB-A+C Charging, 4 Data Ports	Q, V	EUE2-HFOW-1140	2111.60
					1 Power Receptacle, 2 Smart USB-A+C Charging, 1 Data Port, 1 Cable Bay		Q, V	EUE2-HFOW-1212	2222.37	
					1 Power Receptacle, 2 Smart USB-A+C Charging, 3 Data Ports		Q, V	EUE2-HFOW-1230	2222.37	
					1 Power Receptacle, 3 Smart USB-A+C Charging, 1 Cable Bay		Q, V	EUE2-HFOW-1302	2333.14	
					1 Power Receptacle, 3 Smart USB-A+C Charging, 2 Data Ports		Q, V	EUE2-HFOW-1320	2333.14	
					2 Power Receptacles, 2 Data Ports, 1 Cable Bay		Q, V	EUE2-HFOW-2022	2000.83	
					2 Power Receptacles, 4 Data Ports		Q, V	EUE2-HFOW-2040	2000.83	
					2 Power Receptacles, 1 Smart USB-A+C Charging, 1 Data Port, 1 Cable Bay		Q, V	EUE2-HFOW-2112	2111.60	
					2 Power Receptacles, 1 Smart USB-A+C Charging, 3 Data Ports		Q, V	EUE2-HFOW-2130	2111.60	
					2 Power Receptacles, 2 Smart USB-A+C Charging, 1 Cable Bay		Q, V	EUE2-HFOW-2202	2222.37	
					2 Power Receptacles, 2 Smart USB-A+C Charging, 2 Data Ports		Q, V	EUE2-HFOW-2220	2222.37	
					2 Power Receptacles, 3 Smart USB-A+C Charging, 1 Data Port		Q, V	EUE2-HFOW-2310	2333.14	
					2 Power Receptacles, 4 Smart USB-A+C Charging		Q, V	EUE2-HFOW-2400	2443.91	
					3 Power Receptacles, 1 Data Port, 1 Cable Bay	Q, V	EUE2-HFOW-3012	2000.83		
					3 Power Receptacles, 3 Data Ports	Q, V	EUE2-HFOW-3030	2000.83		
					3 Power Receptacles, 1 Smart USB-A+C Charging, 1 Cable Bay	Q, V	EUE2-HFOW-3102	2111.60		
					3 Power Receptacles, 1 Smart USB-A+C Charging, 2 Data Ports	Q, V	EUE2-HFOW-3120	2111.60		
3 Power Receptacles, 2 Smart USB-A+C Charging, 1 Data Port	Q, V	EUE2-HFOW-3210	2222.37							
3 Power Receptacles, 3 Smart USB-A+C Charging	Q, V	EUE2-HFOW-3300	2333.14							
4 Power Receptacles, 1 Cable Bay	Q, V	EUE2-HFOW-4002	2000.83							
4 Power Receptacles, 2 Data Ports	Q, V	EUE2-HFOW-4020	2000.83							
4 Power Receptacles, 1 Smart USB-A+C Charging, 1 Data Port	Q, V	EUE2-HFOW-4110	2111.60							
4 Power Receptacles, 2 Smart USB-A+C Charging	Q, V	EUE2-HFOW-4200	2222.37							
5 Power Receptacles, 1 Data Port	Q, V	EUE2-HFOW-5010	2000.83							
5 Power Receptacles, 1 Smart USB-A+C Charging	Q, V	EUE2-HFOW-5100	2111.60							
6 Power Receptacles	Q, V	EUE2-HFOW-6000	2000.83							

Worksurface Power Modules — Flip Top

Hardwire — Double-Sided

Bezel Depth	Bezel Width	Cord Length	Trim Color	Port Color	Port	Port Configuration	Cutout	Number	Price	
							Code			
							Options			
8" (203mm)	5.31" (135mm)	12' (3658mm)	Black Anodized	Black	4	1 Power Receptacle, 1 Data Port, 1 Cable Bay	M, P	EUE2-HLOB-1012	\$2390.94	
						1 Power Receptacle, 3 Data Ports	M, P	EUE2-HLOB-1030	2390.94	
						1 Power Receptacle, 1 Smart USB-A+C Charging, 1 Cable Bay	M, P	EUE2-HLOB-1102	2501.71	
						1 Power Receptacle, 1 Smart USB-A+C Charging, 2 Data Ports	M, P	EUE2-HLOB-1120	2501.71	
						1 Power Receptacle, 3 Smart USB-A+C Charging	M, P	EUE2-HLOB-1300	2723.25	
						2 Power Receptacles, 1 Cable Bay	M, P	EUE2-HLOB-2002	2390.94	
						2 Power Receptacles, 2 Data Ports	M, P	EUE2-HLOB-2020	2390.94	
						2 Power Receptacles, 1 Smart USB-A+C Charging, 1 Data Port	M, P	EUE2-HLOB-2110	2501.71	
						2 Power Receptacles, 2 Smart USB-A+C Charging	M, P	EUE2-HLOB-2200	2612.48	
						3 Power Receptacles, 1 Data Port	M, P	EUE2-HLOB-3010	2390.94	
						3 Power Receptacles, 1 Smart USB-A+C Charging	M, P	EUE2-HLOB-3100	2501.71	
						4 Power Receptacles	M, P	EUE2-HLOB-4000	2390.94	
						6	1 Power Receptacle, 3 Data Ports, 1 Cable Bay	Q, V	EUE2-HLOB-1032	\$2390.94
						1 Power Receptacle, 5 Data Ports	Q, V	EUE2-HLOB-1050	2390.94	
						1 Power Receptacle, 1 Smart USB-A+C Charging, 2 Data Ports, 1 Cable Bay	Q, V	EUE2-HLOB-1122	2501.71	
						1 Power Receptacle, 1 Smart USB-A+C Charging, 4 Data Ports	Q, V	EUE2-HLOB-1140	2501.71	
						1 Power Receptacle, 2 Smart USB-A+C Charging, 1 Data Port, 1 Cable Bay	Q, V	EUE2-HLOB-1212	2612.48	
						1 Power Receptacle, 2 Smart USB-A+C Charging, 3 Data Ports	Q, V	EUE2-HLOB-1230	2612.48	
						1 Power Receptacle, 3 Smart USB-A+C Charging, 1 Cable Bay	Q, V	EUE2-HLOB-1302	2723.25	
						1 Power Receptacle, 3 Smart USB-A+C Charging, 2 Data Ports	Q, V	EUE2-HLOB-1320	2723.25	
						2 Power Receptacles, 2 Data Ports, 1 Cable Bay	Q, V	EUE2-HLOB-2022	2390.94	
						2 Power Receptacles, 4 Data Ports	Q, V	EUE2-HLOB-2040	2390.94	
						2 Power Receptacles, 1 Smart USB-A+C Charging, 1 Data Port, 1 Cable Bay	Q, V	EUE2-HLOB-2112	2501.71	
						2 Power Receptacles, 1 Smart USB-A+C Charging, 3 Data Ports	Q, V	EUE2-HLOB-2130	2501.71	
						2 Power Receptacles, 2 Smart USB-A+C Charging, 1 Cable Bay	Q, V	EUE2-HLOB-2202	2612.48	
						2 Power Receptacles, 2 Smart USB-A+C Charging, 2 Data Ports	Q, V	EUE2-HLOB-2220	2612.48	
						2 Power Receptacles, 3 Smart USB-A+C Charging, 1 Data Port	Q, V	EUE2-HLOB-2310	2723.25	
						2 Power Receptacles, 4 Smart USB-A+C Charging	Q, V	EUE2-HLOB-2400	2834.02	
						3 Power Receptacles, 1 Data Port, 1 Cable Bay	Q, V	EUE2-HLOB-3012	2390.94	
						3 Power Receptacles, 3 Data Ports	Q, V	EUE2-HLOB-3030	2390.94	
						3 Power Receptacles, 1 Smart USB-A+C Charging, 1 Cable Bay	Q, V	EUE2-HLOB-3102	2501.71	
						3 Power Receptacles, 1 Smart USB-A+C Charging, 2 Data Ports	Q, V	EUE2-HLOB-3120	2501.71	
						3 Power Receptacles, 2 Smart USB-A+C Charging, 1 Data Port	Q, V	EUE2-HLOB-3210	2612.48	
						3 Power Receptacles, 3 Smart USB-A+C Charging	Q, V	EUE2-HLOB-3300	2723.25	
						4 Power Receptacles, 1 Cable Bay	Q, V	EUE2-HLOB-4002	2390.94	
						4 Power Receptacles, 2 Data Ports	Q, V	EUE2-HLOB-4020	2390.94	
						4 Power Receptacles, 1 Smart USB-A+C Charging, 1 Data Port	Q, V	EUE2-HLOB-4110	2501.71	
						4 Power Receptacles, 2 Smart USB-A+C Charging	Q, V	EUE2-HLOB-4200	2612.48	
						5 Power Receptacles, 1 Data Port	Q, V	EUE2-HLOB-5010	2390.94	
						5 Power Receptacles, 1 Smart USB-A+C Charging	Q, V	EUE2-HLOB-5100	2501.71	
6 Power Receptacles	Q, V	EUE2-HLOB-6000	2390.94							

Worksurface Power Modules — Flip Top

Hardwire — Double-Sided

Bezel Depth	Bezel Width	Cord Length	Trim Color	Port Color	Port	Port Configuration	Cutout	Number	Price	
							Code			Options
8" (203mm)	5.31" (135mm)	12' (3658mm)	Clear Anodized	White	4	1 Power Receptacle, 1 Data Port, 1 Cable Bay	M, P	EUE2-HLOW-1012	\$ 2091.35	
						1 Power Receptacle, 3 Data Ports	M, P	EUE2-HLOW-1030	2091.35	
						1 Power Receptacle, 1 Smart USB-A+C Charging, 1 Cable Bay	M, P	EUE2-HLOW-1102	2202.12	
						1 Power Receptacle, 1 Smart USB-A+C Charging, 2 Data Ports	M, P	EUE2-HLOW-1120	2202.12	
						1 Power Receptacle, 3 Smart USB-A+C Charging	M, P	EUE2-HLOW-1300	2423.66	
						2 Power Receptacles, 1 Cable Bay	M, P	EUE2-HLOW-2002	2091.35	
						2 Power Receptacles, 2 Data Ports	M, P	EUE2-HLOW-2020	2091.35	
						2 Power Receptacles, 1 Smart USB-A+C Charging, 1 Data Port	M, P	EUE2-HLOW-2110	2202.12	
						2 Power Receptacles, 2 Smart USB-A+C Charging	M, P	EUE2-HLOW-2200	2312.89	
						3 Power Receptacles, 1 Data Port	M, P	EUE2-HLOW-3010	2091.35	
						3 Power Receptacles, 1 Smart USB-A+C Charging	M, P	EUE2-HLOW-3100	2202.12	
						4 Power Receptacles	M, P	EUE2-HLOW-4000	2091.35	
						6	1 Power Receptacle, 3 Data Ports, 1 Cable Bay	Q, V	EUE2-HLOW-1032	\$ 2091.35
						1 Power Receptacle, 5 Data Ports	Q, V	EUE2-HLOW-1050	2091.35	
						1 Power Receptacle, 1 Smart USB-A+C Charging, 2 Data Ports, 1 Cable Bay	Q, V	EUE2-HLOW-1122	2202.12	
						1 Power Receptacle, 1 Smart USB-A+C Charging, 4 Data Ports	Q, V	EUE2-HLOW-1140	2202.12	
						1 Power Receptacle, 2 Smart USB-A+C Charging, 1 Data Port, 1 Cable Bay	Q, V	EUE2-HLOW-1212	2312.89	
						1 Power Receptacle, 2 Smart USB-A+C Charging, 3 Data Ports	Q, V	EUE2-HLOW-1230	2312.89	
						1 Power Receptacle, 3 Smart USB-A+C Charging, 1 Cable Bay	Q, V	EUE2-HLOW-1302	2423.66	
						1 Power Receptacle, 3 Smart USB-A+C Charging, 2 Data Ports	Q, V	EUE2-HLOW-1320	2423.66	
						2 Power Receptacles, 2 Data Ports, 1 Cable Bay	Q, V	EUE2-HLOW-2022	2091.35	
						2 Power Receptacles, 4 Data Ports	Q, V	EUE2-HLOW-2040	2091.35	
						2 Power Receptacles, 1 Smart USB-A+C Charging, 1 Data Port, 1 Cable Bay	Q, V	EUE2-HLOW-2112	2202.12	
						2 Power Receptacles, 1 Smart USB-A+C Charging, 3 Data Ports	Q, V	EUE2-HLOW-2130	2202.12	
						2 Power Receptacles, 2 Smart USB-A+C Charging, 1 Cable Bay	Q, V	EUE2-HLOW-2202	2312.89	
						2 Power Receptacles, 2 Smart USB-A+C Charging, 2 Data Ports	Q, V	EUE2-HLOW-2220	2312.89	
						2 Power Receptacles, 3 Smart USB-A+C Charging, 1 Data Port	Q, V	EUE2-HLOW-2310	2423.66	
						2 Power Receptacles, 4 Smart USB-A+C Charging	Q, V	EUE2-HLOW-2400	2534.43	
						3 Power Receptacles, 1 Data Port, 1 Cable Bay	Q, V	EUE2-HLOW-3012	2091.35	
						3 Power Receptacles, 3 Data Ports	Q, V	EUE2-HLOW-3030	2091.35	
						3 Power Receptacles, 1 Smart USB-A+C Charging, 1 Cable Bay	Q, V	EUE2-HLOW-3102	2202.12	
						3 Power Receptacles, 1 Smart USB-A+C Charging, 2 Data Ports	Q, V	EUE2-HLOW-3120	2202.12	
						3 Power Receptacles, 2 Smart USB-A+C Charging, 1 Data Port	Q, V	EUE2-HLOW-3210	2312.89	
						3 Power Receptacles, 3 Smart USB-A+C Charging	Q, V	EUE2-HLOW-3300	2423.66	
						4 Power Receptacles, 1 Cable Bay	Q, V	EUE2-HLOW-4002	2091.35	
						4 Power Receptacles, 2 Data Ports	Q, V	EUE2-HLOW-4020	2091.35	
						4 Power Receptacles, 1 Smart USB-A+C Charging, 1 Data Port	Q, V	EUE2-HLOW-4110	2202.12	
						4 Power Receptacles, 2 Smart USB-A+C Charging	Q, V	EUE2-HLOW-4200	2312.89	
						5 Power Receptacles, 1 Data Port	Q, V	EUE2-HLOW-5010	2091.35	
						5 Power Receptacles, 1 Smart USB-A+C Charging	Q, V	EUE2-HLOW-5100	2202.12	
6 Power Receptacles	Q, V	EUE2-HLOW-6000	2091.35							

Worksurface Power Modules — Flush Mounted Power Corded

3-Port:

- (2) Power
- (1) Smart USB-A+C



Power Cord

EUBI-PL0B-2100

4-Port:

- (2) Power
- (1) Smart USB-A+C
- (1) Data

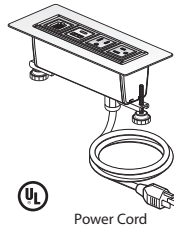

Power Cord

EUBI-PL0B-2110

6-Port:

- (2) Power
- (1) Smart USB-A+C
- (1) Data
- (1) Cable Bay

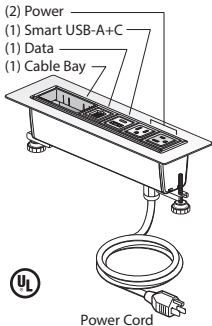

Power Cord

EUBI-PL0B-2112

4-Port:

- (4) Power

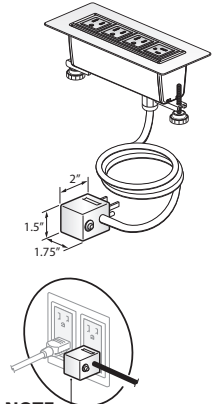

NOTE:

Always Circuit Breaker Plug when more than 3 power outlets specified.

EUBI-PL0B-4000

Class YA – GSA: Open Market

Features

- Includes power module with 3, 4 or 6 ports that can be configured with simplex outlets (NEMA-5-15R), USB charging port (Smart USB-A+C), data ports or cable bay(s) that can accept up to two pull out data/AV cables and mounting hardware.
- Data port accommodate most varieties of field supplied data/ AV jacks.
- Corded power module with 15 amp - 12'(3658mm) long cord with plug (NEMA 5-15P).
- The Smart USB-A+C allows for the 20W to be transferred between the 2 ports. If the USB-A is being used, the full wattage is sent to the USB-A, and the same for the USB-C. If both are being used, the wattage is distributed to each port and the port drawing the most power will receive more watts than the one that is not.
- Attaches to surface with use of included mounting brackets.
- Flush Mount has an overall housing depth of 4"(102mm) and will extend into mounting surface.
- Color option of black painted bezel with black receptacles or white painted bezel with white receptacles.

Specification Tips

- Designed to be used with 1.18"(30mm) and 2"(51mm) thick surfaces with clear space below.
- **Configuration and quantity of power and data ports cannot be modified in the field.**
- **For use with 120 volt 60 hertz power source only.**
- Requires field installation.
- Requires field cut access hole for power cord/conduit routing.
- Specify AV cables separately.
- Cable Bay requires cables less than 0.3"(8mm) diameter.
- Application may require approval of local authority having jurisdiction (AHJ); ensure compliance before placing orders and installation.

To Order, Specify:

- 1) Product number.
(No finish specification required.)

Worksurface Power Modules — Flush Mounted Power Corded

Top Depth	Top Width	Cord Length	Trim Color	Port Color	Port	Configuration	Number	Price						
Corded														
3"(76mm)	6.75"(171mm)	12'(3658mm)	Black	Black	3	1 Power Receptacle, 1 Cable Bay	EUB1-PL0B-1002	\$1044.65						
						1 Power Receptacle, 2 Data Ports	EUB1-PL0B-1020	1044.65						
						1 Power Receptacle, 1 Data Port, 1 Smart USB-A+C Charging	EUB1-PL0B-1110	1158.85						
						1 Power Receptacle, 2 Smart USB-A+C Charging	EUB1-PL0B-1200	1273.05						
						2 Power Receptacles, 1 Data Port	EUB1-PL0B-2010	1044.65						
						2 Power Receptacles, 1 Smart USB-A+C Charging	EUB1-PL0B-2100	1158.85						
						3 Power Receptacles	EUB1-PL0B-3000	1044.65						
3"(76mm)	8.25"(210mm)				4	1 Power Receptacle, 1 Data Port, 1 Cable Bay	EUB1-PL0B-1012	\$ 1143.61						
						1 Power Receptacle, 3 Data Ports	EUB1-PL0B-1030	1143.61						
						1 Power Receptacle, 1 Smart USB-A+C Charging, 1 Cable Bay	EUB1-PL0B-1102	1257.81						
						1 Power Receptacle, 3 Smart USB-A+C Charging	EUB1-PL0B-1300	1486.21						
						2 Power Receptacles, 1 Cable Bay	EUB1-PL0B-2002	1143.61						
						2 Power Receptacles, 2 Data Ports	EUB1-PL0B-2020	1143.61						
						2 Power Receptacles, 1 Smart USB-A+C Charging, 1 Data Port	EUB1-PL0B-2110	1257.81						
						2 Power Receptacles, 2 Smart USB-A+C Charging	EUB1-PL0B-2200	1372.01						
						3 Power Receptacles, 1 Data Port	EUB1-PL0B-3010	1143.61						
						3 Power Receptacles, 1 Smart USB-A+C Charging	EUB1-PL0B-3100	1257.81						
						4 Power Receptacles	EUB1-PL0B-4000	1143.61						
						3"(76mm)	9.75"(248mm)				6	1 Power Receptacle, 1 Smart USB-A+C Charging, 2 Cable Bays	EUB1-PL0B-1104	\$1356.83
												1 Power Receptacle, 1 Smart USB-A+C Charging, 2 Data Ports, 1 Cable Bay	EUB1-PL0B-1122	1356.83
1 Power Receptacle, 1 Smart USB-A+C Charging, 4 Data Ports	EUB1-PL0B-1140	1356.83												
1 Power Receptacle, 2 Smart USB-A+C Charging, 1 Data Port, 1 Cable Bay	EUB1-PL0B-1212	1471.03												
1 Power Receptacle, 2 Smart USB-A+C Charging, 3 Data Ports	EUB1-PL0B-1230	1471.03												
1 Power Receptacle, 3 Smart USB-A+C Charging, 1 Cable Bay	EUB1-PL0B-1302	1585.23												
1 Power Receptacle, 3 Smart USB-A+C Charging, 2 Data Ports	EUB1-PL0B-1320	1585.23												
1 Power Receptacle, 4 Smart USB-A+C Charging, 1 Data Port	EUB1-PL0B-1410	1699.43												
2 Power Receptacles, 2 Cable Bays	EUB1-PL0B-2004	1242.63												
2 Power Receptacles, 2 Data Ports, 1 Cable Bay	EUB1-PL0B-2022	1242.63												
2 Power Receptacles, 4 Data Ports	EUB1-PL0B-2040	1242.63												
2 Power Receptacles, 1 Smart USB-A+C Charging, 1 Data Port, 1 Cable Bay	EUB1-PL0B-2112	1356.83												
2 Power Receptacles, 1 Smart USB-A+C Charging, 3 Data Ports	EUB1-PL0B-2130	1356.83												
2 Power Receptacles, 2 Smart USB-A+C Charging, 1 Cable Bay	EUB1-PL0B-2202	1471.03												
2 Power Receptacles, 2 Smart USB-A+C Charging, 2 Data Ports	EUB1-PL0B-2220	1471.03												
2 Power Receptacles, 3 Smart USB-A+C Charging, 1 Data Port	EUB1-PL0B-2310	1585.23												
2 Power Receptacles, 4 Smart USB-A+C Charging	EUB1-PL0B-2400	1699.43												
3 Power Receptacles, 3 Data Ports	EUB1-PL0B-3030	1242.63												
3 Power Receptacles, 1 Smart USB-A+C Charging, 1 Cable Bay	EUB1-PL0B-3102	1356.83												
3 Power Receptacles, 1 Smart USB-A+C Charging, 2 Data Ports	EUB1-PL0B-3120	1356.83												
3 Power Receptacles, 2 Smart USB-A+C Charging, 1 Data Port	EUB1-PL0B-3210	1471.03												
3 Power Receptacles, 3 Smart USB-A+C Charging	EUB1-PL0B-3300	1585.23												
4 Power Receptacles, 1 Cable Bay	EUB1-PL0B-4002	1242.63												
4 Power Receptacles, 2 Data Ports	EUB1-PL0B-4020	1242.63												
4 Power Receptacles, 1 Smart USB-A+C Charging, 1 Data Port	EUB1-PL0B-4110	1356.83												
4 Power Receptacles, 2 Smart USB-A+C Charging	EUB1-PL0B-4200	1471.03												
5 Power Receptacles, 1 Data Port	EUB1-PL0B-5010	1242.63												
5 Power Receptacles, 1 Smart USB-A+C Charging	EUB1-PL0B-5100	1356.83												
6 Power Receptacles	EUB1-PL0B-6000	1242.63												

Worksurface Power Modules — Flush Mounted Power Corded

Top Depth	Top Width	Cord Length	Trim Color	Port Color	Port	Port Configuration	Number	Price
3"(76mm)	6.75"(171mm)	12'(3658mm)	White	White	3	1 Power Receptacle, 1 Cable Bay	EUB1-PLow-1002	\$1044.65
						1 Power Receptacle, 2 Data Ports	EUB1-PLow-1020	1044.65
						1 Power Receptacle, 1 Data Port, 1 Smart USB-A+C Charging	EUB1-PLow-1110	1158.85
						1 Power Receptacle, 2 Smart USB-A+C Charging	EUB1-PLow-1200	1273.05
						2 Power Receptacles, 1 Data Port	EUB1-PLow-2010	1044.65
						2 Power Receptacles, 1 Smart USB-A+C Charging	EUB1-PLow-2100	1158.85
3"(76mm)	8.25"(210mm)				4	3 Power Receptacles	EUB1-PLow-3000	1044.65
						1 Power Receptacle, 1 Data Port, 1 Cable Bay	EUB1-PLow-1012	\$ 1143.61
						1 Power Receptacle, 3 Data Ports	EUB1-PLow-1030	1143.61
						1 Power Receptacle, 1 Smart USB-A+C Charging, 1 Cable Bay	EUB1-PLow-1102	1257.81
						1 Power Receptacle, 3 Smart USB-A+C Charging	EUB1-PLow-1300	1486.21
						2 Power Receptacles, 1 Cable Bay	EUB1-PLow-2002	1143.61
						2 Power Receptacles, 2 Data Ports	EUB1-PLow-2020	1143.61
						2 Power Receptacles, 1 Smart USB-A+C Charging, 1 Data Port	EUB1-PLow-2110	1257.81
						2 Power Receptacles, 2 Smart USB-A+C Charging	EUB1-PLow-2200	1372.01
						3 Power Receptacles, 1 Data Port	EUB1-PLow-3010	1143.61
3"(76mm)	9.75"(248mm)				6	3 Power Receptacles, 1 Smart USB-A+C Charging	EUB1-PLow-3100	1257.81
						4 Power Receptacles	EUB1-PLow-4000	1143.61
						1 Power Receptacle, 1 Smart USB-A+C Charging, 2 Cable Bays	EUB1-PLow-1104	\$1356.83
						1 Power Receptacle, 1 Smart USB-A+C Charging, 2 Data Ports, 1 Cable Bay	EUB1-PLow-1122	1356.83
						1 Power Receptacle, 1 Smart USB-A+C Charging, 4 Data Ports	EUB1-PLow-1140	1356.83
						1 Power Receptacle, 2 Smart USB-A+C Charging, 1 Data Port, 1 Cable Bay	EUB1-PLow-1212	1471.03
						1 Power Receptacle, 2 Smart USB-A+C Charging, 3 Data Ports	EUB1-PLow-1230	1471.03
						1 Power Receptacle, 3 Smart USB-A+C Charging, 1 Cable Bay	EUB1-PLow-1302	1585.23
						1 Power Receptacle, 3 Smart USB-A+C Charging, 2 Data Ports	EUB1-PLow-1320	1585.23
						1 Power Receptacle, 4 Smart USB-A+C Charging, 1 Data Port	EUB1-PLow-1410	1699.43
						2 Power Receptacles, 2 Cable Bays	EUB1-PLow-2004	1242.63
						2 Power Receptacles, 2 Data Ports, 1 Cable Bay	EUB1-PLow-2022	1242.63
						2 Power Receptacles, 4 Data Ports	EUB1-PLow-2040	1242.63
						2 Power Receptacles, 1 Smart USB-A+C Charging, 1 Data Port, 1 Cable Bay	EUB1-PLow-2112	1356.83
						2 Power Receptacles, 1 Smart USB-A+C Charging, 3 Data Ports	EUB1-PLow-2130	1356.83
						2 Power Receptacles, 2 Smart USB-A+C Charging, 1 Cable Bay	EUB1-PLow-2202	1471.03
						2 Power Receptacles, 2 Smart USB-A+C Charging, 2 Data Ports	EUB1-PLow-2220	1471.03
						2 Power Receptacles, 3 Smart USB-A+C Charging, 1 Data Port	EUB1-PLow-2310	1585.23
						2 Power Receptacles, 4 Smart USB-A+C Charging	EUB1-PLow-2400	1699.43
						3 Power Receptacles, 3 Data Ports	EUB1-PLow-3030	1242.63
3 Power Receptacles, 1 Smart USB-A+C Charging, 1 Cable Bay	EUB1-PLow-3102	1356.83						
3 Power Receptacles, 1 Smart USB-A+C Charging, 2 Data Ports	EUB1-PLow-3120	1356.83						
3 Power Receptacles, 2 Smart USB-A+C Charging, 1 Data Port	EUB1-PLow-3210	1471.03						
3 Power Receptacles, 3 Smart USB-A+C Charging	EUB1-PLow-3300	1585.23						
4 Power Receptacles, 1 Cable Bay	EUB1-PLow-4002	1242.63						
4 Power Receptacles, 2 Data Ports	EUB1-PLow-4020	1242.63						
4 Power Receptacles, 1 Smart USB-A+C Charging, 1 Data Port	EUB1-PLow-4110	1356.83						
4 Power Receptacles, 2 Smart USB-A+C Charging	EUB1-PLow-4200	1471.03						
5 Power Receptacles, 1 Data Port	EUB1-PLow-5010	1242.63						
5 Power Receptacles, 1 Smart USB-A+C Charging	EUB1-PLow-5100	1356.83						
6 Power Receptacles	EUB1-PLow-6000	1242.63						

Worksurface Power Modules — Flush Mounted Power Hardware

3-Port:

- (2) Power
- (1) Smart USB-A+C



Hard Wired

EUBI-HLOB-2100

4-Port:

- (2) Power
- (1) Smart USB-A+C
- (1) Data

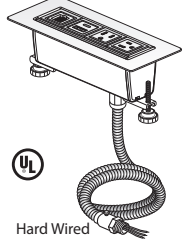

Hard Wired

EUBI-HLOB-2110

6-Port:

- (2) Power
- (1) Smart USB-A+C
- (1) Data
- (1) Cable Bay

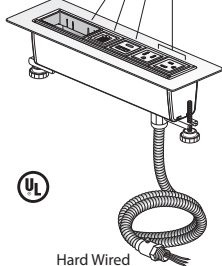

Hard Wired

EUBI-HLOB-2112

Class YA – GSA: Open Market

Features

- Includes power module with 3, 4 or 6 ports that can be configured with simplex outlets (NEMA-5-15R), USB charging port (Smart USB-A+C), data ports or cable bay(s) that can accept up to two pull out data/AV cables and mounting hardware.
- Data port accommodate most varieties of field supplied data/ AV jacks.
- Hardwired power module with 12'(3658mm) long flexible metal conduit feed, 0.5"(13mm) conduit fitting and wires for hardwire connection.
- The Smart USB-A+C allows for the 20W to be transferred between the 2 ports. If the USB-A is being used, the full wattage is sent to the USB-A, and the same for the USB-C. If both are being used, the wattage is distributed to each port and the port drawing the most power will receive more watts than the one that is not.
- Attaches to surface with use of included mounting brackets.
- Flush Mount has an overall housing depth of 4"(102mm) and will extend into mounting surface.
- Color option of black painted bezel with black receptacles or white painted bezel with white receptacles.

Specification Tips

- Designed to be used with 1.18"(30mm) and 2"(51mm) thick surfaces with clear space below.
- **Configuration and quantity of power and data ports cannot be modified in the field.**
- **For use with 120 volt 60 hertz power source only.**
- Requires field installation.
- Requires field cut access hole for power cord/conduit routing.
- Specify AV cables separately.
- Cable Bay requires cables less than 0.3"(8mm) diameter.
- Application may require approval of local authority having jurisdiction (AHJ); ensure compliance before placing orders and installation.

To Order, Specify:

- 1) Product number.
(No finish specification required.)

Worksurface Power Modules — Flush Mounted Power Hardware

Top Depth	Top Width	Conduit Length	Trim Color	Port Color	Port	Power	USB Charging	Data Port	Cable Bay	Description	Number	Price
Corded												
3" (76mm)	6.75" (171mm)	12' (3658mm)	Black	Black	3	1	0	0	2	1 Power Receptacle, 1 Cable Bay	EUBI-HLOB-1002	\$ 1176.85
						1	0	2	0	1 Power Receptacle, 2 Data Ports	EUBI-HLOB-1020	1176.85
						1	1	1	0	1 Power Receptacle, 1 Data Port, 1 Smart USB-A+C Charging	EUBI-HLOB-1110	1291.05
						1	2	0	0	1 Power Receptacle, 2 Smart USB-A+C Charging	EUBI-HLOB-1200	1405.25
						2	0	1	0	2 Power Receptacles, 1 Data Port	EUBI-HLOB-2010	1176.85
						2	1	0	0	2 Power Receptacles, 1 Smart USB-A+C Charging	EUBI-HLOB-2100	1291.05
						3	0	0	0	3 Power Receptacles	EUBI-HLOB-3000	1176.85
3" (76mm)	8.25" (210mm)				4	1	0	1	2	1 Power Receptacle, 1 Data Port, 1 Cable Bay	EUBI-HLOB-1012	\$ 1275.81
						1	0	3	0	1 Power Receptacle, 3 Data Ports	EUBI-HLOB-1030	1275.81
						1	1	0	2	1 Power Receptacle, 1 Smart USB-A+C Charging, 1 Cable Bay	EUBI-HLOB-1102	1390.01
						1	3	0	0	1 Power Receptacle, 3 Smart USB-A+C Charging	EUBI-HLOB-1300	1618.41
						2	0	0	2	2 Power Receptacles, 1 Cable Bay	EUBI-HLOB-2002	1275.81
						2	0	2	0	2 Power Receptacles, 2 Data Ports	EUBI-HLOB-2020	1275.81
						2	1	1	0	2 Power Receptacles, 1 Smart USB-A+C Charging, 1 Data Port	EUBI-HLOB-2110	1390.01
						2	2	0	0	2 Power Receptacles, 2 Smart USB-A+C Charging	EUBI-HLOB-2200	1504.21
						3	0	1	0	3 Power Receptacles, 1 Data Port	EUBI-HLOB-3010	1275.81
						3	1	0	0	3 Power Receptacles, 1 Smart USB-A+C Charging	EUBI-HLOB-3100	1390.01
						4	0	0	0	4 Power Receptacles	EUBI-HLOB-4000	1275.81
3" (76mm)	9.75" (248mm)				6	1	1	0	4	1 Power Receptacle, 1 Smart USB-A+C Charging, 2 Cable Bays	EUBI-HLOB-1104	\$ 1489.03
						1	1	2	2	1 Power Receptacle, 1 Smart USB-A+C Charging, 2 Data Ports, 1 Cable Bay	EUBI-HLOB-1122	1489.03
						1	1	4	0	1 Power Receptacle, 1 Smart USB-A+C Charging, 4 Data Ports	EUBI-HLOB-1140	1489.03
						1	2	1	2	1 Power Receptacle, 2 Smart USB-A+C Charging, 1 Data Port, 1 Cable Bay	EUBI-HLOB-1212	1603.23
						1	2	3	0	1 Power Receptacle, 2 Smart USB-A+C Charging, 3 Data Ports	EUBI-HLOB-1230	1603.23
						1	3	0	2	1 Power Receptacle, 3 Smart USB-A+C Charging, 1 Cable Bay	EUBI-HLOB-1302	1717.43
						1	3	2	0	1 Power Receptacle, 3 Smart USB-A+C Charging, 2 Data Ports	EUBI-HLOB-1320	1717.43
						1	4	1	0	1 Power Receptacle, 4 Smart USB-A+C Charging, 1 Data Port	EUBI-HLOB-1410	1831.63
						2	0	0	4	2 Power Receptacles, 2 Cable Bays	EUBI-HLOB-2004	1374.83
						2	0	2	2	2 Power Receptacles, 2 Data Ports, 1 Cable Bay	EUBI-HLOB-2022	1374.83
						2	0	4	0	2 Power Receptacles, 4 Data Ports	EUBI-HLOB-2040	1374.83
						2	1	1	2	2 Power Receptacles, 1 Smart USB-A+C Charging, 1 Data Port, 1 Cable Bay	EUBI-HLOB-2112	1489.03
						2	1	3	0	2 Power Receptacles, 1 Smart USB-A+C Charging, 3 Data Ports	EUBI-HLOB-2130	1489.03
						2	2	0	2	2 Power Receptacles, 2 Smart USB-A+C Charging, 1 Cable Bay	EUBI-HLOB-2202	1603.23
						2	2	2	0	2 Power Receptacles, 2 Smart USB-A+C Charging, 2 Data Ports	EUBI-HLOB-2220	1603.23
						2	3	1	0	2 Power Receptacles, 3 Smart USB-A+C Charging, 1 Data Port	EUBI-HLOB-2310	1717.43
						2	4	0	0	2 Power Receptacles, 4 Smart USB-A+C Charging	EUBI-HLOB-2400	1831.63
						3	0	3	0	3 Power Receptacles, 3 Data Ports	EUBI-HLOB-3030	1374.83
						3	1	0	2	3 Power Receptacles, 1 Smart USB-A+C Charging, 1 Cable Bay	EUBI-HLOB-3102	1489.03
						3	1	2	0	3 Power Receptacles, 1 Smart USB-A+C Charging, 2 Data Ports	EUBI-HLOB-3120	1489.03
						3	2	1	0	3 Power Receptacles, 2 Smart USB-A+C Charging, 1 Data Port	EUBI-HLOB-3210	1603.23
						3	3	0	0	3 Power Receptacles, 3 Smart USB-A+C Charging	EUBI-HLOB-3300	1717.43
						4	0	0	2	4 Power Receptacles, 1 Cable Bay	EUBI-HLOB-4002	1374.83
						4	0	2	0	4 Power Receptacles, 2 Data Ports	EUBI-HLOB-4020	1374.83
						4	1	1	0	4 Power Receptacles, 1 Smart USB-A+C Charging, 1 Data Port	EUBI-HLOB-4110	1489.03
						4	2	0	0	4 Power Receptacles, 2 Smart USB-A+C Charging	EUBI-HLOB-4200	1603.23
						5	0	1	0	5 Power Receptacles, 1 Data Port	EUBI-HLOB-5010	1374.83
						5	1	0	0	5 Power Receptacles, 1 Smart USB-A+C Charging	EUBI-HLOB-5100	1489.03
						6	0	0	0	6 Power Receptacles	EUBI-HLOB-6000	1374.83

Worksurface Power Modules — Flush Mounted Power Hardware

Top Depth	Top Width	Conduit Length	Trim Color	Port Color	Port	Power	USB Charging	Data Port	Cable Bay	Description	Number	Price
3" (76mm)	6.75" (171mm)	12' (3658mm)	White	White	3	1	0	0	2	1 Power Receptacle, 1 Cable Bay	EUB1-HLOW-1002	\$ 1176.85
						1	0	2	0	1 Power Receptacle, 2 Data Ports	EUB1-HLOW-1020	1176.85
						1	1	1	0	1 Power Receptacle, 1 Data Port, 1 Smart USB-A+C Charging	EUB1-HLOW-1110	1291.05
						1	2	0	0	1 Power Receptacle, 2 Smart USB-A+C Charging	EUB1-HLOW-1200	1405.25
						2	0	1	0	2 Power Receptacles, 1 Data Port	EUB1-HLOW-2010	1176.85
						2	1	0	0	2 Power Receptacles, 1 Smart USB-A+C Charging	EUB1-HLOW-2100	1291.05
						3	0	0	0	3 Power Receptacles	EUB1-HLOW-3000	1176.85
3" (76mm)	8.25" (210mm)				4	1	0	1	2	1 Power Receptacle, 1 Data Port, 1 Cable Bay	EUB1-HLOW-1012	\$ 1275.81
						1	0	3	0	1 Power Receptacle, 3 Data Ports	EUB1-HLOW-1030	1275.81
						1	1	0	2	1 Power Receptacle, 1 Smart USB-A+C Charging, 1 Cable Bay	EUB1-HLOW-1102	1390.01
						1	3	0	0	1 Power Receptacle, 3 Smart USB-A+C Charging	EUB1-HLOW-1300	1618.41
						2	0	0	2	2 Power Receptacles, 1 Cable Bay	EUB1-HLOW-2002	1275.81
						2	0	2	0	2 Power Receptacles, 2 Data Ports	EUB1-HLOW-2020	1275.81
						2	1	1	0	2 Power Receptacles, 1 Smart USB-A+C Charging, 1 Data Port	EUB1-HLOW-2110	1390.01
						2	2	0	0	2 Power Receptacles, 2 Smart USB-A+C Charging	EUB1-HLOW-2200	1504.21
						3	0	1	0	3 Power Receptacles, 1 Data Port	EUB1-HLOW-3010	1275.81
						3	1	0	0	3 Power Receptacles, 1 Smart USB-A+C Charging	EUB1-HLOW-3100	1390.01
						4	0	0	0	4 Power Receptacles	EUB1-HLOW-4000	1275.81
3" (76mm)	9.75" (248mm)				6	1	1	0	4	1 Power Receptacle, 1 Smart USB-A+C Charging, 2 Cable Bays	EUB1-HLOW-1104	\$ 1489.03
						1	1	2	2	1 Power Receptacle, 1 Smart USB-A+C Charging, 2 Data Ports, 1 Cable Bay	EUB1-HLOW-1122	1489.03
						1	1	4	0	1 Power Receptacle, 1 Smart USB-A+C Charging, 4 Data Ports	EUB1-HLOW-1140	1489.03
						1	2	1	2	1 Power Receptacle, 2 Smart USB-A+C Charging, 1 Data Port, 1 Cable Bay	EUB1-HLOW-1212	1603.23
						1	2	3	0	1 Power Receptacle, 2 Smart USB-A+C Charging, 3 Data Ports	EUB1-HLOW-1230	1603.23
						1	3	0	2	1 Power Receptacle, 3 Smart USB-A+C Charging, 1 Cable Bay	EUB1-HLOW-1302	1717.43
						1	3	2	0	1 Power Receptacle, 3 Smart USB-A+C Charging, 2 Data Ports	EUB1-HLOW-1320	1717.43
						1	4	1	0	1 Power Receptacle, 4 Smart USB-A+C Charging, 1 Data Port	EUB1-HLOW-1410	1831.63
						2	0	0	4	2 Power Receptacles, 2 Cable Bays	EUB1-HLOW-2004	1374.83
						2	0	2	2	2 Power Receptacles, 2 Data Ports, 1 Cable Bay	EUB1-HLOW-2022	1374.83
						2	0	4	0	2 Power Receptacles, 4 Data Ports	EUB1-HLOW-2040	1374.83
						2	1	1	2	2 Power Receptacles, 1 Smart USB-A+C Charging, 1 Data Port, 1 Cable Bay	EUB1-HLOW-2112	1489.03
						2	1	3	0	2 Power Receptacles, 1 Smart USB-A+C Charging, 3 Data Ports	EUB1-HLOW-2130	1489.03
						2	2	0	2	2 Power Receptacles, 2 Smart USB-A+C Charging, 1 Cable Bay	EUB1-HLOW-2202	1603.23
						2	2	2	0	2 Power Receptacles, 2 Smart USB-A+C Charging, 2 Data Ports	EUB1-HLOW-2220	1603.23
						2	3	1	0	2 Power Receptacles, 3 Smart USB-A+C Charging, 1 Data Port	EUB1-HLOW-2310	1717.43
						2	4	0	0	2 Power Receptacles, 4 Smart USB-A+C Charging	EUB1-HLOW-2400	1831.63
						3	0	3	0	3 Power Receptacles, 3 Data Ports	EUB1-HLOW-3030	1374.83
						3	1	0	2	3 Power Receptacles, 1 Smart USB-A+C Charging, 1 Cable Bay	EUB1-HLOW-3102	1489.03
						3	1	2	0	3 Power Receptacles, 1 Smart USB-A+C Charging, 2 Data Ports	EUB1-HLOW-3120	1489.03
						3	2	1	0	3 Power Receptacles, 2 Smart USB-A+C Charging, 1 Data Port	EUB1-HLOW-3210	1603.23
						3	3	0	0	3 Power Receptacles, 3 Smart USB-A+C Charging	EUB1-HLOW-3300	1717.43
						4	0	0	2	4 Power Receptacles, 1 Cable Bay	EUB1-HLOW-4002	1374.83
						4	0	2	0	4 Power Receptacles, 2 Data Ports	EUB1-HLOW-4020	1374.83
						4	1	1	0	4 Power Receptacles, 1 Smart USB-A+C Charging, 1 Data Port	EUB1-HLOW-4110	1489.03
						4	2	0	0	4 Power Receptacles, 2 Smart USB-A+C Charging	EUB1-HLOW-4200	1603.23
						5	0	1	0	5 Power Receptacles, 1 Data Port	EUB1-HLOW-5010	1374.83
						5	1	0	0	5 Power Receptacles, 1 Smart USB-A+C Charging	EUB1-HLOW-5100	1489.03
						6	0	0	0	6 Power Receptacles	EUB1-HLOW-6000	1374.83

Worksurface Power Modules — Flush Mounted Power Spiral Cord for Height Adjustable

3-Port:

- (2) Power
- (1) Smart USB-A+C

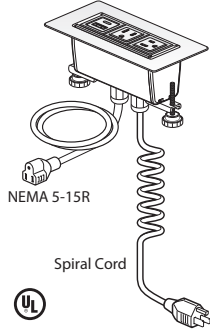

EUB1-SFOB-2100

4-Port:

- (2) Power
- (1) Smart USB-A+C
- (1) Data

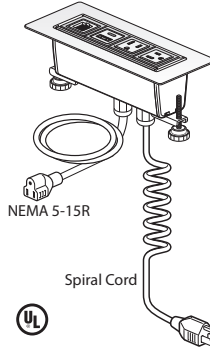

EUB1-SFOB-2110

6-Port:

- (2) Power
- (1) Smart USB-A+C
- (1) Data
- (1) Cable Bay

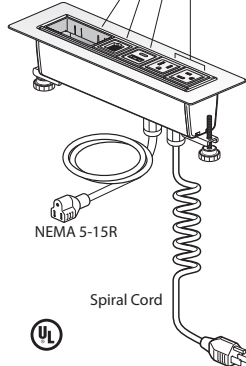

EUB1-SFOB-2112

Class YA – GSA: Open Market

Features

- Includes power module with 3, 4 or 6 ports that can be configured with simplex outlets (NEMA-5-15R), USB charging port (Smart USB-A+C), data ports or cable bay(s) that can accept up to two pull out data/AV cables and mounting hardware.
- Data port accommodate most varieties of field supplied data/ AV jacks.
- Spiral Cord includes 15 amp plug (NEMA 5-15P) and expands to 12'(3658mm) when stretched.
- Auxiliary 24"(610mm) power cord with NEMA 5-15R used to provide power to table motor controller.
- The Smart USB-A+C allows for the 20W to be transferred between the 2 ports. If the USB-A is being used, the full wattage is sent to the USB-A, and the same for the USB-C. If both are being used, the wattage is distributed to each port and the port drawing the most power will receive more watts than the one that is not.
- Attaches to surface with use of included mounting brackets.
- Flush Mount has an overall housing depth of 4"(102mm) and will extend into mounting surface.
- Color option of black painted bezel with black receptacles or white painted bezel with white receptacles.

Specification Tips

- **Configuration and quantity of power and data ports cannot be modified in the field.**
- **For use with 120 volt 60 hertz power source only.**
- **For use with Height Adjustable Tables or Benching.**
- Not for use with cable chain.
- Requires field installation.
- Requires field cut access hole for power cord/conduit routing.
- Specify AV cables separately.
- Cable Bay requires cables less than 0.3"(8mm) diameter.
- Application may require approval of local authority having jurisdiction (AHJ); ensure compliance before placing orders and installation.

4-Port:

- (4) Power

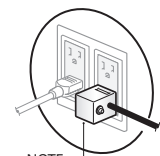
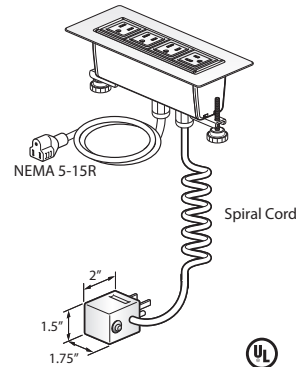

NOTE:
Always Circuit Breaker Plug
when more than 3
power outlets specified.

EUB1-SFOB-4000

To Order, Specify:

- 1) Product number.
(No finish specification required.)

Worksurface Power Modules — Flush Mounted Power Spiral Cord for Height Adjustable

Top Depth	Top Width	Cord Length	Trim Color	Port Color	Port	Configuration	Number	Price
Corded								
3"(76mm)	6.75"(171mm)	10'(3048mm)	Black	Black	3	2 Power Receptacles, 1 Data Port	EUBI-SFOB-2010	\$ 1377.25
						2 Power Receptacles, 1 Smart USB-A+C Charging	EUBI-SFOB-2100	1491.45
						3 Power Receptacles	EUBI-SFOB-3000	1377.25
3"(76mm)	8.25"(210mm)				4	2 Power Receptacles, 1 Cable Bay	EUBI-SFOB-2002	1476.21
						2 Power Receptacles, 2 Data Ports	EUBI-SFOB-2020	1476.21
						2 Power Receptacles, 1 Smart USB-A+C Charging, 1 Data Port	EUBI-SFOB-2110	1590.41
						2 Power Receptacles, 2 Smart USB-A+C Charging	EUBI-SFOB-2200	1704.61
						3 Power Receptacles, 1 Data Port	EUBI-SFOB-3010	1476.21
						3 Power Receptacles, 1 Smart USB-A+C Charging	EUBI-SFOB-3100	1590.41
						4 Power Receptacles	EUBI-SFOB-4000	1476.21
3"(76mm)	9.75"(248mm)				6	2 Power Receptacles, 2 Cable Bays	EUBI-SFOB-2004	\$ 1575.23
						2 Power Receptacles, 2 Data Ports, 1 Cable Bay	EUBI-SFOB-2022	1575.23
						2 Power Receptacles, 4 Data Ports	EUBI-SFOB-2040	1575.23
						2 Power Receptacles, 1 Smart USB-A+C Charging, 1 Data Port, 1 Cable Bay	EUBI-SFOB-2112	1689.43
						2 Power Receptacles, 1 Smart USB-A+C Charging, 3 Data Ports	EUBI-SFOB-2130	1689.43
						2 Power Receptacles, 2 Smart USB-A+C Charging, 1 Cable Bay	EUBI-SFOB-2202	1803.63
						2 Power Receptacles, 2 Smart USB-A+C Charging, 2 Data Ports	EUBI-SFOB-2220	1803.63
						2 Power Receptacles, 3 Smart USB-A+C Charging, 1 Data Port	EUBI-SFOB-2310	1917.83
						2 Power Receptacles, 4 Smart USB-A+C Charging	EUBI-SFOB-2400	2032.03
						3 Power Receptacles, 1 Smart USB-A+C Charging, 1 Cable Bay	EUBI-SFOB-3012	1575.23
						3 Power Receptacles, 3 Data Ports	EUBI-SFOB-3030	1575.23
						3 Power Receptacles, 1 Smart USB-A+C Charging, 1 Cable Bay	EUBI-SFOB-3102	1689.43
						3 Power Receptacles, 1 Smart USB-A+C Charging, 2 Data Ports	EUBI-SFOB-3120	1689.43
						3 Power Receptacles, 2 Smart USB-A+C Charging, 1 Data Port	EUBI-SFOB-3210	1803.63
						3 Power Receptacles, 3 Smart USB-A+C Charging	EUBI-SFOB-3300	1917.83
						4 Power Receptacles, 1 Cable Bay	EUBI-SFOB-4002	1575.23
4 Power Receptacles, 2 Data Ports	EUBI-SFOB-4020	1575.23						
4 Power Receptacles, 1 Smart USB-A+C Charging, 1 Data Port	EUBI-SFOB-4110	1689.43						
4 Power Receptacles, 2 Smart USB-A+C Charging	EUBI-SFOB-4200	1803.63						
5 Power Receptacles, 1 Data Port	EUBI-SFOB-5010	1575.23						
5 Power Receptacles, 1 Smart USB-A+C Charging	EUBI-SFOB-5100	1689.43						
6 Power Receptacles	EUBI-SFOB-6000	1575.23						

Worksurface Power Modules — Flush Mounted Power Spiral Cord for Height Adjustable

Top Depth	Top Width	Cord Length	Trim Color	Port Color	Port	Configuration	Number	Price
3"(76mm)	6.75"(171mm)	10'(3048mm)	White	White	3	2 Power Receptacles, 1 Data Port	EUBI-SFOW-2010	\$ 1377.25
						2 Power Receptacles, 1 Smart USB-A+C Charging	EUBI-SFOW-2100	1491.45
						3 Power Receptacles	EUBI-SFOW-3000	1377.25
3"(76mm)	8.25"(210mm)				4	2 Power Receptacles, 1 Cable Bay	EUBI-SFOW-2002	\$ 1476.21
						2 Power Receptacles, 2 Data Ports	EUBI-SFOW-2020	1476.21
						2 Power Receptacles, 1 Smart USB-A+C Charging, 1 Data Port	EUBI-SFOW-2110	1590.41
						2 Power Receptacles, 2 Smart USB-A+C Charging	EUBI-SFOW-2200	1704.61
						3 Power Receptacles, 1 Data Port	EUBI-SFOW-3010	1476.21
						3 Power Receptacles, 1 Smart USB-A+C Charging	EUBI-SFOW-3100	1590.41
						4 Power Receptacles	EUBI-SFOW-4000	1476.21
3"(76mm)	9.75"(248mm)				6	2 Power Receptacles, 2 Cable Bays	EUBI-SFOW-2004	\$ 1575.23
						2 Power Receptacles, 2 Data Ports, 1 Cable Bay	EUBI-SFOW-2022	1575.23
						2 Power Receptacles, 4 Data Ports	EUBI-SFOW-2040	1575.23
						2 Power Receptacles, 1 Smart USB-A+C Charging, 1 Data Port, 1 Cable Bay	EUBI-SFOW-2112	1689.43
						2 Power Receptacles, 1 Smart USB-A+C Charging, 3 Data Ports	EUBI-SFOW-2130	1689.43
						2 Power Receptacles, 2 Smart USB-A+C Charging, 1 Cable Bay	EUBI-SFOW-2202	1803.63
						2 Power Receptacles, 2 Smart USB-A+C Charging, 2 Data Ports	EUBI-SFOW-2220	1803.63
						2 Power Receptacles, 3 Smart USB-A+C Charging, 1 Data Port	EUBI-SFOW-2310	1917.83
						2 Power Receptacles, 4 Smart USB-A+C Charging	EUBI-SFOW-2400	2032.03
						3 Power Receptacles, 1 Smart USB-A+C Charging, 1 Cable Bay	EUBI-SFOW-3012	1575.23
						3 Power Receptacles, 3 Data Ports	EUBI-SFOW-3030	1575.23
						3 Power Receptacles, 1 Smart USB-A+C Charging, 1 Cable Bay	EUBI-SFOW-3102	1689.43
						3 Power Receptacles, 1 Smart USB-A+C Charging, 2 Data Ports	EUBI-SFOW-3120	1689.43
						3 Power Receptacles, 2 Smart USB-A+C Charging, 1 Data Port	EUBI-SFOW-3210	1803.63
						3 Power Receptacles, 3 Smart USB-A+C Charging	EUBI-SFOW-3300	1917.83
						4 Power Receptacles, 1 Cable Bay	EUBI-SFOW-4002	1575.23
4 Power Receptacles, 2 Data Ports	EUBI-SFOW-4020	1575.23						
4 Power Receptacles, 1 Smart USB-A+C Charging, 1 Data Port	EUBI-SFOW-4110	1689.43						
4 Power Receptacles, 2 Smart USB-A+C Charging	EUBI-SFOW-4200	1803.63						
5 Power Receptacles, 1 Data Port	EUBI-SFOW-5010	1575.23						
5 Power Receptacles, 1 Smart USB-A+C Charging	EUBI-SFOW-5100	1689.43						
6 Power Receptacles	EUBI-SFOW-6000	1575.23						

Worksurface Power Modules — Flush Mounted Power Cord for Height Adjustable

3-Port:

- (2) Power
- (1) Smart USB-A+C

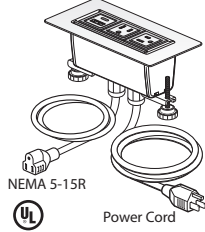

EUBI-SLOB-2100

4-Port:

- (2) Power
- (1) Smart USB-A+C
- (1) Data

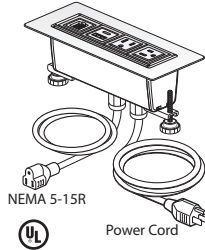

EUBI-SLOB-2110

6-Port:

- (2) Power
- (1) Smart USB-A+C
- (1) Data
- (1) Cable Bay

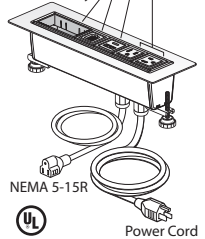

EUBI-SLOB-2112

4-Port:

- (4) Power

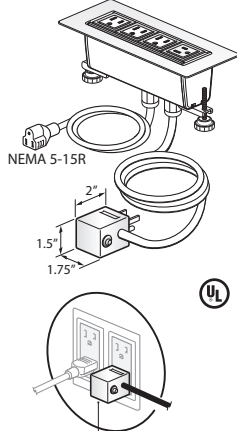

NOTE:
Always Circuit Breaker Plug
when more than 3
power outlets specified.

EUBI-SLOB-4000

Class YA – GSA: Open Market

Features

- Includes power module with 3, 4 or 6 ports that can be configured with simplex outlets (NEMA-5-15R), USB charging port (Smart USB-A+C), data ports or cable bay(s) that can accept up to two pull out data/AV cables and mounting hardware.
- Data port accommodate most varieties of field supplied data/ AV jacks.
- Corded power module with 15 amp - 12'(3658mm) long cord with plug (NEMA 5-15P).
- Auxiliary 24"(610mm) power cord with NEMA 5-15R used to provide power to table motor controller.
- The Smart USB-A+C allows for the 20W to be transferred between the 2 ports. If the USB-A is being used, the full wattage is sent to the USB-A, and the same for the USB-C. If both are being used, the wattage is distributed to each port and the port drawing the most power will receive more watts than the one that is not.
- Attaches to surface with use of included mounting brackets.
- Flush Mount has an overall housing depth of 4"(102mm) and will extend into mounting surface.
- Color option of black painted bezel with black receptacles or white painted bezel with white receptacles.

Specification Tips

- **Configuration and quantity of power and data ports cannot be modified in the field.**
- **For use with 120 volt 60 hertz power source only.**
- **For use with Height Adjustable Tables or Benching.**
- Designed to be used with cable chain.
- Requires field installation.
- Requires field cut access hole for power cord/conduit routing.
- Specify AV cables separately.
- Cable Bay requires cables less than 0.3"(8mm) diameter.
- Application may require approval of local authority having jurisdiction (AHJ); ensure compliance before placing orders and installation.

To Order, Specify:

- 1) Product number.
(No finish specification required.)

Worksurface Power Modules — Flush Mounted Power Cord for Height Adjustable

Top Depth	Top Width	Cord Length	Trim Color	Port Color	Port	Configuration	Number	Price
Corded								
3"(76mm)	6.75"(171mm)	12'(3658mm)	Black	Black	3	2 Power Receptacles, 1 Data Port	EUBI-SLOB-2010	\$1470.31
						2 Power Receptacles, 1 Smart USB-A+C Charging	EUBI-SLOB-2100	1584.51
						3 Power Receptacles	EUBI-SLOB-3000	1470.31
3"(76mm)	8.25"(210mm)				4	2 Power Receptacles, 1 Cable Bay	EUBI-SLOB-2002	\$1569.27
						2 Power Receptacles, 2 Data Ports	EUBI-SLOB-2020	1569.27
						2 Power Receptacles, 1 Smart USB-A+C Charging, 1 Data Port	EUBI-SLOB-2110	1683.47
						2 Power Receptacles, 2 Smart USB-A+C Charging	EUBI-SLOB-2200	1797.67
						3 Power Receptacles, 1 Data Port	EUBI-SLOB-3010	1569.27
						3 Power Receptacles, 1 Smart USB-A+C Charging	EUBI-SLOB-3100	1683.47
						4 Power Receptacles	EUBI-SLOB-4000	1569.27
3"(76mm)	9.75"(248mm)				6	2 Power Receptacles, 2 Cable Bays	EUBI-SLOB-2004	\$1668.29
						2 Power Receptacles, 2 Data Ports, 1 Cable Bay	EUBI-SLOB-2022	1668.29
						2 Power Receptacles, 4 Data Ports	EUBI-SLOB-2040	1668.29
						2 Power Receptacles, 1 Smart USB-A+C Charging, 1 Data Port, 1 Cable Bay	EUBI-SLOB-2112	1782.49
						2 Power Receptacles, 1 Smart USB-A+C Charging, 3 Data Ports	EUBI-SLOB-2130	1782.49
						2 Power Receptacles, 2 Smart USB-A+C Charging, 1 Cable Bay	EUBI-SLOB-2202	1896.69
						2 Power Receptacles, 2 Smart USB-A+C Charging, 2 Data Ports	EUBI-SLOB-2220	1896.69
						2 Power Receptacles, 3 Smart USB-A+C Charging, 1 Data Port	EUBI-SLOB-2310	2010.89
						2 Power Receptacles, 4 Smart USB-A+C Charging	EUBI-SLOB-2400	2125.09
						3 Power Receptacles, 1 Smart USB-A+C Charging, 1 Cable Bay	EUBI-SLOB-3012	1668.29
						3 Power Receptacles, 3 Data Ports	EUBI-SLOB-3030	1668.29
						3 Power Receptacles, 1 Smart USB-A+C Charging, 1 Cable Bay	EUBI-SLOB-3102	1782.49
						3 Power Receptacles, 1 Smart USB-A+C Charging, 2 Data Ports	EUBI-SLOB-3120	1782.49
						3 Power Receptacles, 2 Smart USB-A+C Charging, 1 Data Port	EUBI-SLOB-3210	1896.69
						3 Power Receptacles, 3 Smart USB-A+C Charging	EUBI-SLOB-3300	2010.89
						4 Power Receptacles, 1 Cable Bay	EUBI-SLOB-4002	1668.29
4 Power Receptacles, 2 Data Ports	EUBI-SLOB-4020	1668.29						
4 Power Receptacles, 1 Smart USB-A+C Charging, 1 Data Port	EUBI-SLOB-4110	1782.49						
4 Power Receptacles, 2 Smart USB-A+C Charging	EUBI-SLOB-4200	1896.69						
5 Power Receptacles, 1 Data Port	EUBI-SLOB-5010	1668.29						
5 Power Receptacles, 1 Smart USB-A+C Charging	EUBI-SLOB-5100	1782.49						
6 Power Receptacles	EUBI-SLOB-6000	1668.29						

Worksurface Power Modules — Flush Mounted Power Cord for Height Adjustable

Top Depth	Top Width	Cord Length	Trim Color	Port Color	Port	Configuration	Number	Price
3"(76mm)	6.75"(171mm)	12'(3658mm)	White	White	3	2 Power Receptacles, 1 Data Port	EUBI-SLOW-2010	\$1470.31
						2 Power Receptacles, 1 Smart USB-A+C Charging	EUBI-SLOW-2100	1584.51
						3 Power Receptacles	EUBI-SLOW-3000	1470.31
3"(76mm)	8.25"(210mm)				4	2 Power Receptacles, 1 Cable Bay	EUBI-SLOW-2002	\$1569.27
						2 Power Receptacles, 2 Data Ports	EUBI-SLOW-2020	1569.27
						2 Power Receptacles, 1 Smart USB-A+C Charging, 1 Data Port	EUBI-SLOW-2110	1683.47
						2 Power Receptacles, 2 Smart USB-A+C Charging	EUBI-SLOW-2200	1797.67
						3 Power Receptacles, 1 Data Port	EUBI-SLOW-3010	1569.27
						3 Power Receptacles, 1 Smart USB-A+C Charging	EUBI-SLOW-3100	1683.47
						4 Power Receptacles	EUBI-SLOW-4000	1569.27
3"(76mm)	9.75"(248mm)				6	2 Power Receptacles, 2 Cable Bays	EUBI-SLOW-2004	\$1668.29
						2 Power Receptacles, 2 Data Ports, 1 Cable Bay	EUBI-SLOW-2022	1668.29
						2 Power Receptacles, 4 Data Ports	EUBI-SLOW-2040	1668.29
						2 Power Receptacles, 1 Smart USB-A+C Charging, 1 Data Port, 1 Cable Bay	EUBI-SLOW-2112	1782.49
						2 Power Receptacles, 1 Smart USB-A+C Charging, 3 Data Ports	EUBI-SLOW-2130	1782.49
						2 Power Receptacles, 2 Smart USB-A+C Charging, 1 Cable Bay	EUBI-SLOW-2202	1896.69
						2 Power Receptacles, 2 Smart USB-A+C Charging, 2 Data Ports	EUBI-SLOW-2220	1896.69
						2 Power Receptacles, 3 Smart USB-A+C Charging, 1 Data Port	EUBI-SLOW-2310	2010.89
						2 Power Receptacles, 4 Smart USB-A+C Charging	EUBI-SLOW-2400	2125.09
						3 Power Receptacles, 1 Smart USB-A+C Charging, 1 Cable Bay	EUBI-SLOW-3012	1668.29
						3 Power Receptacles, 3 Data Ports	EUBI-SLOW-3030	1668.29
						3 Power Receptacles, 1 Smart USB-A+C Charging, 1 Cable Bay	EUBI-SLOW-3102	1782.49
						3 Power Receptacles, 1 Smart USB-A+C Charging, 2 Data Ports	EUBI-SLOW-3120	1782.49
						3 Power Receptacles, 2 Smart USB-A+C Charging, 1 Data Port	EUBI-SLOW-3210	1896.69
						3 Power Receptacles, 3 Smart USB-A+C Charging	EUBI-SLOW-3300	2010.89
						4 Power Receptacles, 1 Cable Bay	EUBI-SLOW-4002	1668.29
4 Power Receptacles, 2 Data Ports	EUBI-SLOW-4020	1668.29						
4 Power Receptacles, 1 Smart USB-A+C Charging, 1 Data Port	EUBI-SLOW-4110	1782.49						
4 Power Receptacles, 2 Smart USB-A+C Charging	EUBI-SLOW-4200	1896.69						
5 Power Receptacles, 1 Data Port	EUBI-SLOW-5010	1668.29						
5 Power Receptacles, 1 Smart USB-A+C Charging	EUBI-SLOW-5100	1782.49						
6 Power Receptacles	EUBI-SLOW-6000	1668.29						

Worksurface Power Modules — Flush Mounted Power Round

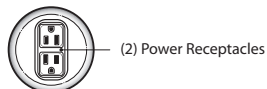
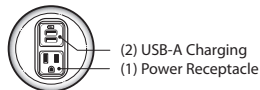
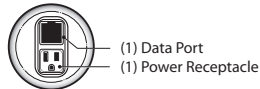
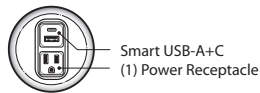
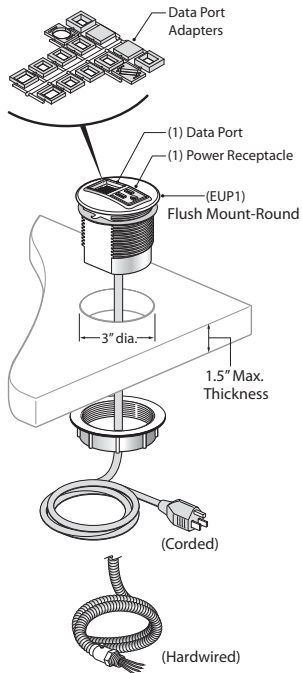

EUP1-PF
EUP1-HF



Class YA

Features

- Includes power module with 2 ports configured with simplex outlets (NEMA-5-15R), USB charging port or data ports and mounting hardware.
- Power Modules specified with a data port includes a variety of data port adapters and blank covers, which accommodate most varieties of field supplied data/AV jacks.
- The Smart USB-A+C allows for the 20W to be transferred between the 2 ports. If the USB-A is being used, the full wattage is sent to the USB-A, and the same for the USB-C. If both are being used, the wattage is distributed to each port and the port drawing the most power will receive more watts than the one that is not.
- Corded power module with 15 amp - 6'(1829mm) or 10'(3048mm) long cord with plug (NEMA 5-15P).
- Hardwire power module with 6'(1829mm) or 10'(3048mm) long flexible galvanized metal conduit.
- Smart USB-A+C can provide fast charge for a mobile phone and tablets. Occupies one charging port.

Specification Tips

- Installs into a 3" diameter hole into surfaces with a maximum thickness of 1.5".
- Configuration and quantity of power and data ports cannot be modified in the field.
- For use with 120 volt 60 hertz power source only.
- Requires field installation.
- Specify AV cables separately.
- Application may require approval of local authority having jurisdiction (AHJ); ensure compliance before placing orders and installation.

To Order, Specify:

- 1) Product number.
- 2) Trim color.
TR-PM1 Silver
TR-PM2 Midnight Black
TR-PM3 Parchment

Cord Length	Port	Configuration	Number	Price
Corded				
6'(1829mm)	2	1 Power Receptacle, 1 Data Port	EUP1-PFOP-100010	\$346.17
		1 Power Receptacle, 1 Smart USB-A+C Charging	EUP1-PFOP-101000	527.96
		2 Power Receptacles	EUP1-PFOP-200000	354.09
10'(3048mm)	2	1 Power Receptacle, 1 Data Port	EUP1-PJOP-100010	\$373.03
		1 Power Receptacle, 1 Smart USB-A+C Charging	EUP1-PJOP-101000	554.82
		2 Power Receptacles	EUP1-PJOP-200000	380.95
Hardwire				
6'(1829mm)	2	1 Power Receptacle, 1 Data Port	EUP1-HFOP-100010	\$457.27
		1 Power Receptacle, 1 Smart USB-A+C Charging	EUP1-HFOP-101000	639.06
		2 Power Receptacles	EUP1-HFOP-200000	465.19
10'(3048mm)	2	1 Power Receptacle, 1 Data Port	EUP1-HJOP-100010	\$484.13
		1 Power Receptacle, 1 Smart USB-A+C Charging	EUP1-HJOP-101000	665.92
		2 Power Receptacles	EUP1-HJOP-200000	492.05

Worksurface Power Modules — Power Tap

Horizontal

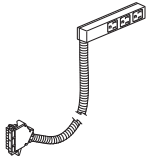

EUET-0030-3M3N
EUET-0030-2M3N
EUET-0030-4M3N



Class YA

Features

- Includes Power Tap housing with three 15A receptacle outlets (NEMA 5-15R) with 0.375"(10mm) conduit and Power Base connector.
- **Power Base connector is used to connect to PDA.**
- Power Tap housing with receptacles available in charcoal or graphite finish; conduit standard in black only.
- Field installed.

To Order, Specify:

- 1) Product number.
- 2) Trim color.
TR-K Charcoal
TR-J Graphite

Specification Tips:

- Specify conduit length, circuit configuration and circuit access with Power Base connector.
- Specify mounting bracket separately.
 - Fixed Bracket with three patch cord holder mounts Power Tap to edge of worksurface with mounting screws. **Horizontal Power Tap required.**
 - Adjustable bracket mounts Power Tap to edge of worksurface with thumb screws for ease of relocation. **Horizontal Power Tap required.**
- Application may require approval of local authority having jurisdiction (AHJ); ensure compliance before placing orders and installation.
- Do not mix 3-circuit and 6-circuit with 4-circuit components. Do not mix 2+2 and 3+1 components. Components have unique polarity key and color coding (3-circuit=black, 6-circuit=ivory, 2+2=blue and 3+1=green).

Description	Circuit Access	Number	Price
3-Circuit Conduit Length			
30"(762mm)	1	EUET-0030-3M3N1NL	\$247.12
	2	EUET-0030-3M3N2NL	247.12
	3	EUET-0030-3M3N3NL	247.12
6'(1829mm)	1	EUET-0072-3M3N1NL	\$287.44
	2	EUET-0072-3M3N2NL	287.44
	3	EUET-0072-3M3N3NL	287.44
9'(2743mm)	1	EUET-00A8-3M3N1NL	\$322.00
	2	EUET-00A8-3M3N2NL	322.00
	3	EUET-00A8-3M3N3NL	322.00
4-Circuit, (2+2) Conduit Length			
30"(762mm)	1	EUET-0030-2M3N1NL	\$247.12
	2	EUET-0030-2M3N2NL	247.12
	3	EUET-0030-2M3N3NL	247.12
	4	EUET-0030-2M3N4NL	247.12
6'(1829mm)	1	EUET-0072-2M3N1NL	\$287.44
	2	EUET-0072-2M3N2NL	287.44
	3	EUET-0072-2M3N3NL	287.44
	4	EUET-0072-2M3N4NL	287.44
9'(2743mm)	1	EUET-00A8-2M3N1NL	\$322.00
	2	EUET-00A8-2M3N2NL	322.00
	3	EUET-00A8-2M3N3NL	322.00
	4	EUET-00A8-2M3N4NL	322.00
4-Circuit, (3+1) Conduit Length			
30"(762mm)	1	EUET-0030-4M3N1NL	\$247.12
	2	EUET-0030-4M3N2NL	247.12
	3	EUET-0030-4M3N3NL	247.12
	4	EUET-0030-4M3N4NL	247.12
6'(1829mm)	1	EUET-0072-4M3N1NL	\$287.44
	2	EUET-0072-4M3N2NL	287.44
	3	EUET-0072-4M3N3NL	287.44
	4	EUET-0072-4M3N4NL	287.44
9'(2743mm)	1	EUET-00A8-4M3N1NL	\$322.00
	2	EUET-00A8-4M3N2NL	322.00
	3	EUET-00A8-4M3N3NL	322.00
	4	EUET-00A8-4M3N4NL	322.00

Worksurface Power Modules — Power Tap

Vertical

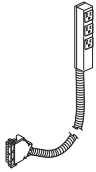

EUET-0030-3M3N
EUET-0030-2M3N
EUET-0030-4M3N



Class YA

Features

- Includes Power Tap housing with three 15A receptacle outlets (NEMA 5-15R) with 0.375"(10mm) conduit and Power Base connector.
- **Power Base connector is used to connect to PDA.**
- Power Tap housing with receptacles available in charcoal or graphite finish; conduit standard in black only.
- Field installed.

Specification Tips:

- Specify conduit length, circuit configuration and circuit access with Power Base connector.
- Specify mounting bracket separately.
 - Fixed Bracket with three patch cord holder mounts Power Tap to edge of worksurface with mounting screws. **Horizontal Power Tap required.**
 - Adjustable bracket mounts Power Tap to edge of worksurface with thumb screws for ease of relocation. **Horizontal Power Tap required.**
 - Application may require approval of local authority having jurisdiction (AHJ); ensure compliance before placing orders and installation.
 - Do not mix 3-circuit and 6-circuit with 4-circuit components. Do not mix 2+2 and 3+1 components. Components have unique polarity key and color coding (3-circuit=black, 6-circuit=ivory, 2+2=blue and 3+1=green).

To Order, Specify:

- 1) Product number.
- 2) Trim color.
 - TR-K Charcoal
 - TR-J Graphite

Description	Circuit Access	Number	Price
3-Circuit Conduit Length			
30"(762mm)	1	EUET-0030-3M3N1NS	\$247.12
	2	EUET-0030-3M3N2NS	247.12
	3	EUET-0030-3M3N3NS	247.12
6'(1829mm)	1	EUET-0072-3M3N1NS	\$287.44
	2	EUET-0072-3M3N2NS	287.44
	3	EUET-0072-3M3N3NS	287.44
9'(2743mm)	1	EUET-00A8-3M3N1NS	\$322.00
	2	EUET-00A8-3M3N2NS	322.00
	3	EUET-00A8-3M3N3NS	322.00
4-Circuit (2+2) Conduit Length			
30"(762mm)	1	EUET-0030-2M3N1NS	\$247.12
	2	EUET-0030-2M3N2NS	247.12
	3	EUET-0030-2M3N3NS	247.12
	4	EUET-0030-2M3N4NS	247.12
6'(1829mm)	1	EUET-0072-2M3N1NS	\$287.44
	2	EUET-0072-2M3N2NS	287.44
	3	EUET-0072-2M3N3NS	287.44
	4	EUET-0072-2M3N4NS	287.44
9'(2743mm)	1	EUET-00A8-2M3N1NS	\$322.00
	2	EUET-00A8-2M3N2NS	322.00
	3	EUET-00A8-2M3N3NS	322.00
	4	EUET-00A8-2M3N4NS	322.00
4-Circuit (3+1) Conduit Length			
30"(762mm)	1	EUET-0030-4M3N1NS	\$247.12
	2	EUET-0030-4M3N2NS	247.12
	3	EUET-0030-4M3N3NS	247.12
	4	EUET-0030-4M3N4NS	247.12
6'(1829mm)	1	EUET-0072-4M3N1NS	\$287.44
	2	EUET-0072-4M3N2NS	287.44
	3	EUET-0072-4M3N3NS	287.44
	4	EUET-0072-4M3N4NS	287.44
9'(2743mm)	1	EUET-00A8-4M3N1NS	\$322.00
	2	EUET-00A8-4M3N2NS	322.00
	3	EUET-00A8-4M3N3NS	322.00
	4	EUET-00A8-4M3N4NS	322.00

Worksurface Power Modules — Power Tap

Hardwire and Corded

Hardwire

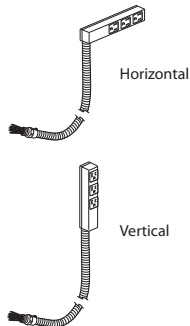

EUET-0030-CM3N



Class YA

Features

- Includes Power Tap with three 15A receptacle outlets (MEMA 5-15) with conduit and conduit fitting.
- Hardwire option for connection to field wired junction box with 0.5”(13mm) knockout.
- Power Tap housing with receptacles available in charcoal or graphite finish; conduit standard in black only.
- Field installed.

Specification Tips

- **For use with 120 volt 60 hertz power source only.**
- **Specify mounting bracket separately.**
 - Fixed Bracket with three patch cord holder mounts Power Tap to edge of worksurface with mounting screws. **Horizontal Power Tap required.**
 - Adjustable bracket mounts Power Tap to edge of worksurface with thumb screws for ease of relocation. **Horizontal Power Tap required.**
 - Under Surface bracket mounts Power Tap under worksurface. **Vertical Power Tap required.**
- Application may require approval of local authority having jurisdiction (AHJ); ensure compliance before placing orders and installation.

To Order, Specify:

- 1) Product number.
- 2) Trim color.
 - TR-K Charcoal
 - TR-J Graphite

Description	Circuit	Number	Price
Hardwire Length — Horizontal			
30”(762mm)	1	EUET-0030-CM3N1NL	\$247.12
6”(1829mm)	1	EUET-0072-CM3N1NL	287.44
9”(2743mm)	1	EUET-00A8-CM3N1NL	322.00
15”(4572mm)	1	EUET-00J0-CM3N1NL	391.12
Hardwire Length — Vertical			
30”(762mm)	1	EUET-0030-CM3N1NS	\$247.12
6”(1829mm)	1	EUET-0072-CM3N1NS	287.44
9”(2743mm)	1	EUET-00A8-CM3N1NS	322.00
15”(4572mm)	1	EUET-00J0-CM3N1NS	391.12

Corded

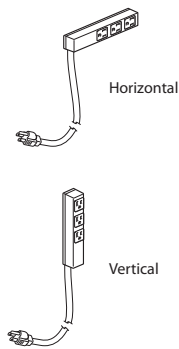

EUET-0000-1M3N



Class YA

Features

- Includes Power Tap with three 15A receptacle outlets (MEMA 5-15R) with cord and plug (15A NEMA 5-15-P).
- Power Tap housing with receptacles available in charcoal or graphite finish; cord standard in black only.
- Field installed.

Specification Tips

- **For use with 120 volt 60 hertz power source only.**
- **Specify mounting bracket separately.**
 - Fixed Bracket with three patch cord holder mounts Power Tap to edge of worksurface with mounting screws. **Horizontal Power Tap required.**
 - Adjustable bracket mounts Power Tap to edge of worksurface with thumb screws for ease of relocation. **Horizontal Power Tap required.**
 - Under Surface bracket mounts Power Tap under worksurface. **Vertical Power Tap required.**
- Application may require approval of local authority having jurisdiction (AHJ); ensure compliance before placing orders and installation.

To Order, Specify:

- 1) Product number.
- 2) Trim color.
 - TR-K Charcoal
 - TR-J Graphite

Description	Circuit	Number	Price
Corded Length — Horizontal			
6”(1829mm)	1	EUET-0000-1M3N16L	\$ 175.06
9”(2743mm)	1	EUET-0000-1M3N19L	187.42
15”(4572mm)	1	EUET-0000-1M3N1EL	212.14
25”(7620mm)	1	EUET-0000-1M3N1YL	253.34
Corded Length — Vertical			
6”(1829mm)	1	EUET-0000-1M3N16S	\$ 175.06
9”(2743mm)	1	EUET-0000-1M3N19S	187.42
15”(4572mm)	1	EUET-0000-1M3N1ES	212.14
25”(7620mm)	1	EUET-0000-1M3N1YS	253.34

Worksurface Power Modules — Power Tap Brackets

Fixed

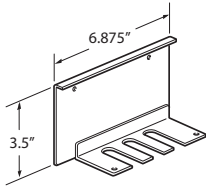

ZUAP-0000-PFD
Class YA

Features

- Includes one Power Tap mounting bracket and mounting hardware.
- Fixed Bracket mounts Power Tap to edge of worksurface with mounting screws.
- Fixed bracket accommodates three patch cords.
- **Horizontal Power Tap required.**

Specification Tips

- **Accommodates 1.18" (30mm) thick tops with clear space below.**
- Power Tap applications should be reviewed by local authorities (electrical inspector) prior to ordering due to varying local codes.
- **Not compatible with the Power Tap-Corded shipped prior to July 2013.**

To Order, Specify:

- 1) Product number.
- 2) Trim color.

Description	Number	Trim	
		A	B
	ZUAP-0000-PFD	\$75.35	\$86.15

Adjustable

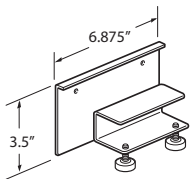

ZUAP-0000-PAN
Class YA

Features

- Includes one Power Tap mounting bracket and mounting hardware.
- Adjustable bracket mounts Power Tap to back edge of worksurface with thumb screws for ease of relocation.
- **Horizontal Power Tap required.**

Specification Tips

- **Accommodates 1.18" (30mm) thick tops with clear space below.**
- Adjustable Power Tap Bracket may interfere with Screen application.
- Power Tap applications should be reviewed by local authorities (electrical inspector) prior to ordering due to varying local codes.
- **Not compatible with the Power Tap-Corded shipped prior to July 2013.**

To Order, Specify:

- 1) Product number.
- 2) Trim color.

Description	Number	Trim	
		A	B
	ZUAP-0000-PAN	\$94.72	\$105.52

Under Surface

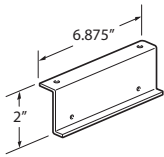

ZUAP-000-PUR
Class YA

Features

- Includes one Power Tap mounting bracket and mounting hardware.
- Under Surface bracket mounts Power Tap under worksurface.
- **Vertical Power Tap required.**

Specification Tips

- **Accommodates 1.18" (30mm) thick tops with clear space below.**
- Under surface bracket may be used on top of worksurface in restricted reach (ADA) applications. Mounting screws will deface top of worksurface.
- Power Tap applications should be reviewed by local authorities (electrical inspector) prior to ordering due to varying local codes.
- **Not compatible with the Power Tap-Corded shipped prior to July 2013.**

To Order, Specify:

- 1) Product number.
- 2) Trim color.

Description	Number	Trim	
		A	B
Under Surface — Right-hand	ZUAP-0000-PUR	\$75.35	\$86.15
Under Surface — Left-hand	ZUAP-0000-PUL	75.35	86.15

Bracket with Grommet

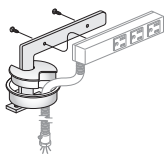

ZUAP-0000-PGH
Class YA

Features

- Includes one Power Tap bracket, grommet with cover and mounting hardware.
- Horizontal bracket mounts to top through field installed grommet. Horizontal Power Tap required.
- Vertical bracket mounts to top through field installed grommet. Vertical Power Tap required.

Specification Tips

- **Accommodates 1.18" (30mm) thick tops with clear space below.**
- Application may require approval of local authority having jurisdiction (AHJ); ensure compliance before placing orders and installation.
- Power Tap Bracket with grommet can only be used with 3-Circuit, 4-Circuit and Hardwired power taps.

To Order, Specify:

- 1) Product number.
- 2) Trim color.

Description	Number	Trim	
		A	B
Fixed Grommet — Horizontal	ZUAP-0000-PGH	\$170.06	\$180.86
Fixed Grommet — Vertical	ZUAP-0000-PGV	170.06	180.86

Worksurface Power Modules — Other Power and Data

Data Bezel

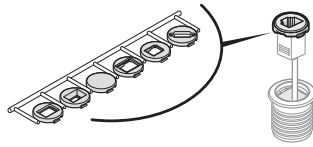

EURT-0000-N001CB
EURT-0000-N001CW

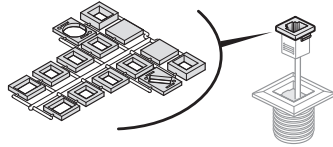

EURT-0000-N001SB
EURT-0000-N001SW
Class QA

Features

- Includes one round or square bezel for the Bezel Utility Module.
- Available in black or supplier white only.

To Order, Specify:

- 1) Product number.
(No finish specification required.)

Description	Number	Price
Round		
Black	EURT-0000-N001CB	\$132.85
White	EURT-0000-N001CW	132.85
Square		
Black	EURT-0000-N001SB	\$132.85
White	EURT-0000-N001SW	132.85

Bezel Utility Module

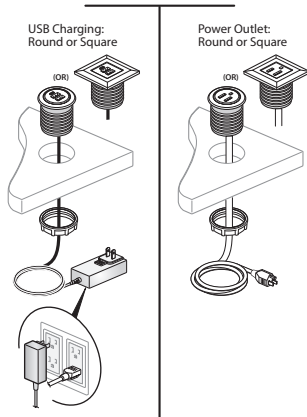

EURT-0072-1100
EURT-0072-1010



Features

- Includes: Either a round or square faced Power Module and mounting hardware.
- For use on surfaces 0.75"(19mm) - 1.44"(37mm) thick.
- Available with either:
 - One power outlet (NEMA 5-15R)
 - One two port USB charger. Consists of two USB outlets with 1000mA of charging power (5 volts) per USB outlet.
 - One data/video jack
- Available in black or supplier white only.

Specification Tips

- For use with 120 volt 60 hertz power source only.
- Power configuration has one cord with plug (NEMA 5-15P).
- USB configuration has one cord with 2"(51mm) x 1"(25mm) x 3"(76mm) voltage transformer plug. Transformer may block adjacent outlets (see illustration).
- Data jacks and AV cables field supplied.
- Data jack adapters accommodate most varieties of field supplied data jacks or separately specified AV cables.
- Requires field cut 1.75"(44mm) hole and field installation.
- Application may require approval of local authority having jurisdiction (AHJ); ensure compliance before placing orders and installing.

To Order, Specify:

- 1) Product number, including:

1 Shape:

- S** Square
- C** Round

2 Color Options:

- B** Black
- W** White

Description	Depth	Number	12	Price
6'(1829mm) Cord				
Power	1.75"(44mm)	EURT-0072-1100	■ ■	\$ 132.85
USB		EURT-0072-1010	■ ■	398.58
12'(3658mm) Cord				
Power	1.75"(44mm)	EURT-00E4-1100	■ ■	\$ 227.75
USB		EURT-00E4-1010	■ ■	493.48

Worksurface Power Modules — Other Power and Data

Collaborative Power Station

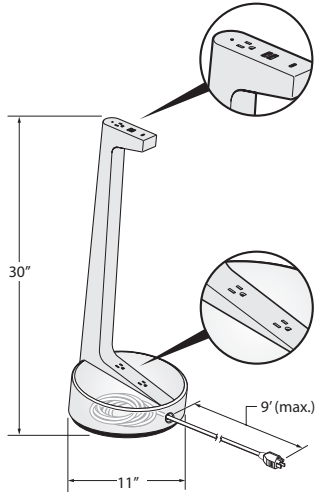

EUCN-PJ



Class YA

Features

- Includes power module with 5 ports (3 on the top and 2 on the bottom) configured with simplex outlets (NEMA-5-15R) and USB charging port.
- Corded power module with 15 amp - 9'(2743mm) long cord with plug (NEMA 5-15P). Ensure power is within 9'(2743mm) of desired location.
- USB-A provides two 10W charging ports.
- USB-C 18W provides a single 18w USB-C port that can provide a fast charge for mobile phones and tablets.
- Color options:
 - Fog/Matte Fog
 - Storm/Matte Storm
 - Black/Matte Black
 - Fog/Weathered Aspen Veneer

Specification Tips

- Configuration and quantity of power and data ports cannot be modified in the field.
- For use with 120 volt 60 hertz power source only.
- Requires field installation.
- Application may require approval of local authority having jurisdiction (AHJ); ensure compliance before placing orders and installation.

To Order, Specify:

- 1) Product number.
(No finish specification required.)

Color	Number	Price
Fog/Matte Fog	EUCN-PJOF-311	\$1525.32
Storm/Matte Storm	EUCN-PJOS-311	1525.32
Black/Matte Black	EUCN-PJOB-311	1525.32

Worksurface Power Modules — Other Power and Data

Retrofit USB Charging Cable

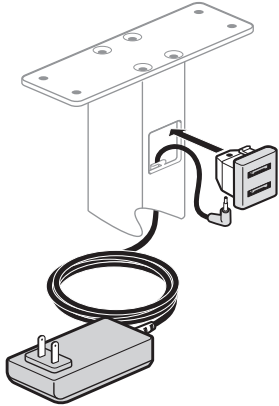

EUDX-3000-B



Class TK

Features

- Includes one USB charging simplex (with two USB outlets) with 72"(1829mm) cord and power supply.
- Installs in an open data port in one of the following products:
 - Flip Top Unit
 - Double Sided Flip Top Unit
 - Quick Connect Power
 - Flush Mount Module
 - Enhanced Power Module
- USB Charging Port consists of 2 USB outlets. 1,000mA of charging power per USB outlet.
- A power supply attached to the worksurface should be used when Retrofit USB Charging Cable is located on Height Adjustable Tables or Benching.

To Order, Specify:

- 1) Product number.
(No finish specification required.)

Length	Description	Color	Number	Price
72"(1829mm)		Black	EUDX-U000-B	\$217.12
		White	EUDX-U000-W	217.12

Cables

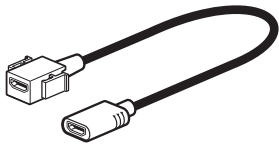

EUDX-H000-B

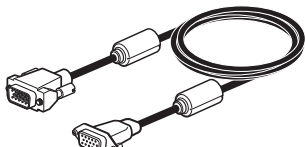

EUDX-V000-B



EUDX-3000-B

Class TK

Features

- Includes one black HDMI Coupler, one VGA cable or one 3.5mm mini audio cable.
- Installs in an open data port in one of the following products:
 - Flip Top Unit
 - Double Sided Flip Top Unit
 - Quick Connect Power
 - Flush Mount Module
 - Enhanced Power Module
 - Data Bezel

Specification Tips

- Provides communication between components: i.e. laptop, processor, monitor, etc.
- HDMI transmits digital video signals.
- VGA transmits analog video signals without audio.

To Order, Specify:

- 1) Product number.
(No finish specification required.)

Length	Description	Color	Number	Price
HDMI Coupler				
N/A	HDMI	Black	EUDX-H000-B	\$235.69
N/A	HDMI	White	EUDX-H000-W	235.69
VGA Cable				
120"(3048mm)	VGA	Black	EUDX-V000-B	\$282.83
	VGA	White	EUDX-V000-W	282.83
Audio Cable — 3.5mm				
120"(3048mm)	VGA	Black	EUDX-3000-B	\$ 66.01
	VGA	White	EUDX-3000-W	66.01

Cable Management — Horizontal

Dual-Hinged Cable Management Tray — Application Chart

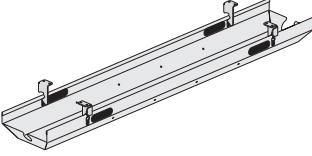
Product Name	Approved Table Depths	Approved Table Widths	Reduce Tray Width Leg Clearance	Example Calculation To Determine Tray Width
 Upside - Height Adjustable Table C-Leg and T-Leg/Rectangle Top	29"(737mm)	46"(1168mm), 52"(1321mm), 58"(1473mm), 64"(1626mm), 70"(1778mm), 76"(1930mm), 82"(2083mm)	22"(559mm)	64"(1626mm) Table Width - 22"(559mm) Reduce Tray Width 42"(1067mm) Tray Width
	Planes - Height Adjustable Table C-Leg/Rectangle Top	29"(737mm)	58"(1473mm), 64"(1626mm), 70"(1778mm)	22"(559mm)
Planes LT Model Height Adjustable Table C-Leg and T-Leg/Rectangle Top	29"(737mm)	58"(1473mm), 64"(1626mm), 70"(1778mm)	22"(559mm)	64"(1626mm) Table Width - 22"(559mm) Reduce Tray Width 42"(1067mm) Tray Width
Masters Series Height Adjustable Table Rectangle Top	30"(762mm), 36"(914mm), 42"(1067mm)	60"(1524mm), 66"(1676mm), 72"(1829mm)	22"(559mm)	64"(1626mm) Table Width - 22"(559mm) Reduce Tray Width 42"(1067mm) Tray Width
Masters Series Height Adjustable Table with Storage Integration Rectangle Top	30"(762mm), 36"(914mm), 42"(1067mm)	66"(1676mm), 72"(1829mm), 78"(1981mm), 84"(2134mm)	30"(762mm)	66"(1676mm) Table Width - 30"(762mm) Reduce Tray Width 36"(914mm) Tray Width
Jive Table - Dual Disc Base Rectangle Top	30"(762mm), 36"(914mm), 42"(1067mm)	72"(1829mm), 84"(2134mm), 96"(2438mm)	36"(914mm)	72"(1829mm) Table Width - 36"(914mm) Reduce Tray Width 36"(914mm) Tray Width
Jive Table - T-Leg - Round Column Rectangle Top	36"(914mm)	66"(1676mm), 72"(1829mm), 84"(2134mm)	12"(305mm)	66"(1676mm) Table Width - 12"(305mm) Reduce Tray Width 54"(1372mm) Tray Width
Jive Table - T-Leg - Extruded Column Rectangle Top	30"(762mm), 36"(914mm)	54"(1372mm), 60"(1524mm), 66"(1676mm), 72"(1829mm)	18"(457mm)	60"(1524mm) Table Width - 18"(457mm) Reduce Tray Width 42"(1067mm) Tray Width
Jive Table - C-Leg Extruded and Round Column Rectangle Top	30"(762mm)	54"(1372mm), 60"(1524mm), 66"(1676mm), 72"(1829mm)	18"(457mm)	72"(1829mm) Table Width - 18"(457mm) Reduce Tray Width 54"(1372mm) Tray Width
Jive Table Post Round Base and Post Extruded Base Rectangle Top	30"(762mm), 36"(914mm)	42"(1067mm), 48"(1219mm), 54"(1372mm), 60"(1524mm), 66"(1676mm), 72"(1829mm), 84"(2134mm)	6"(152mm)	42"(1067mm) Table Width - 6"(152mm) Reduce Tray Width 36"(914mm) Tray Width
Adaptable Worksurface Rectangle Worksurface	30"(762mm)	42"(1067mm), 48"(1219mm), 54"(1372mm), 60"(1524mm), 72"(1829mm)	6"(152mm)	48"(1219mm) Table Width - 6"(152mm) Reduce Tray Width 42"(1067mm) Tray Width
Cultivate Table Frames	36"(914mm), 42"(1067mm)	60"(1524mm), 72"(1829mm) Wide Frames	12"(305mm)	60"(1524mm) Table Width - 12"(305mm) Reduce Tray Width 48"(1219mm) Tray Width
		84"(2134mm), 96"(2438mm) Wide Frames	12"(305mm)	84"(2134mm) Table Width - 12"(305mm) Reduce Tray Width 72"(1829mm) Tray Width (use two 36"(914mm) wide trays)

Cable Management — Horizontal

Dual-Hinged Cable Management Tray — Metal

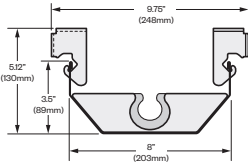
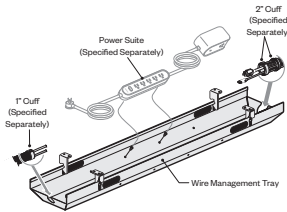

EUWT
Class YA - GSA: Open Market

Features

- Includes one metal tray and four attachment brackets with thumb tabs to assist with opening tray.
- Tray flips down to provide access to power and data cords. It can be accessed by the back or the user side.
- Belong Plug Strip can be mounted into the tray.
- Tray can accept both the 1" (25mm) and 2" (51mm) Cuffs. Reverse tray for correct opening.

Specification Tips

- Tray width must be undersized due to the understructure of the table. See Dual-Hinged Cable Management Tray — Application Chart.
- Not designed to be used on 23" (584mm) D tables or worksurfaces due to knee clearance.
- 1.5H storage placed under a fixed worksurface will not have enough clearance for a Dual-Hinged Cable Management Tray.
- Not designed for use on Flip Top Tables (Planes or Jive).
- Product is available in all standard trim colors.

To Order, Specify:

- 1) Product number.
- 2) Trim color.

Description	Number	Trim	
		A	B
22"(559mm)	EUWT-0822-P	\$234.13	\$250.93
30"(762mm)	EUWT-0830-P	245.73	262.53
36"(914mm)	EUWT-0836-P	254.43	271.23
42"(1067mm)	EUWT-0842-P	263.13	279.93
48"(1219mm)	EUWT-0848-P	271.83	288.63
54"(1372mm)	EUWT-0854-P	280.53	297.33
60"(1524mm)	EUWT-0860-P	289.23	306.03

Cable Management — Horizontal

Cable Management Basket — Metal

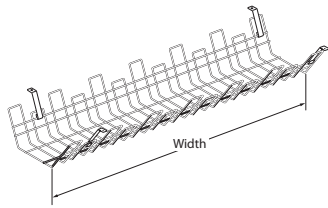

TAWB
Class YA – GSA: Open Market

Features

- Includes one basket, four brackets and attachment hardware.
- Standard in black.
- Basket is 8.5”(203mm) deep x 3.5”(76mm) high. With mounting hardware overall height is 4.94”(102mm) and depth is 10.82”(254mm).
- Accessible from both sides.
- Basket detaches without tools.

Specification Tips

- Verify mounting clearance with table understructure.
- Separately specify covers.

To Order, Specify:

- 1) Product number.
(No finish specification required.)

Width	Number	Price
18”(457mm)	TAWB-0918	\$ 192.86
24”(610mm)	TAWB-0924	202.56
36”(914mm)	TAWB-0936	221.89

Cover for Cable Management Basket — Metal

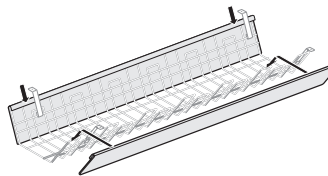

TABC (Two covers shown)
Class YA – GSA: Open Market

Features

- Includes one painted cover.

Specification Tips

- Designed to be used with cable management basket. Up to two can be installed.
- Order to match cable management basket width.

To Order, Specify:

- 1) Product number.
 - 2) Trim color.
- Note:** \$15.63 upcharge list for Metallic and Accent trim colors.

Width	Number	Price
18”(457mm)	TABC-0918	\$ 53.26
24”(610mm)	TABC-0924	71.51
36”(914mm)	TABC-0936	107.90

Cable Management Channel — PET

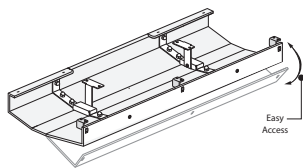

AKWN
Class YA – GSA Open Market

Features

- Includes one PET (Polyethylene Terephthalate) cable manager, tray and attachment hardware.
- Available in three colors: Dusk, Flint, and Mink.
- Ships unassembled.

Specification Tips

- Not for use with Compose Echo table.
- Not designed for use on Flip Top Tables (Planes or Jive).
- Use a low profile monitor arm bracket with the tray.
- Application may require approval of local authority having jurisdiction (AHJ); ensure compliance before placing orders and installation.

To Order, Specify:

- 1) Product number.
- 2) PET color.
PET-C1 Dusk
PET-C2 Flint
PET-C4 Mink

Depth	Width	Number	Price
12”(305mm)	30”(762mm)	AKWN-1230-EUN	\$404.13

Fixed Cable Management Tray — Metal

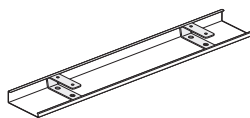

EUAW-NH
Class YA

Features

- Includes one cable manager and attachment clips.
- Standard in light platinum.
- Field installed.
- Manages and stores wire and cables under horizontal surfaces.

To Order, Specify:

- 1) Product number.
(No finish specification required.)

Length	Clips	Number	Price
48”(1219mm)	2	EUAW-0048-NH	\$ 237.35
72”(1829mm)	3	EUAW-0072-NH	356.01
96”(2438mm)	3	EUAW-0096-NH	474.67
120”(3048mm)	4	EUAW-0000-NH	593.13

Cable Management — Horizontal

72" J-Channel Cable Manager — Plastic

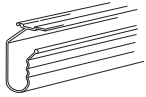

4TJC-72
Class YA

Features

- Includes J-Channel and mounting hardware.
- Field-installed.
- Provides cable management below table tops.
- Attaches to the underside of the table top with screws.
- J-channel to be field cut to length.
- Available in black finish color only.

To Order, Specify:

- 1) Product number.
(No finish specification required.)

Length	Height	Width	Description	Number	Price
72"(1829mm)	4.25"(108mm)	2.75"(70mm)	Straight table	4TJC-72	\$322.99

15" Mini J-Channel Cable Manager — Plastic

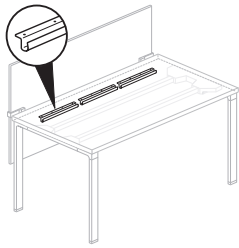

WUAW-PNH
Class YA

Features

- Includes ten plastic cable managers and attachment hardware.
- Manages and stores wires or cables under horizontal surface.
- Standard in charcoal trim color only.

To Order, Specify:

- 1) Product number.
(No finish specification required.)

Length	Depth	Number	Price
15"(381mm)	2"(51mm)	WUAW-1500-PNH	\$339.02

Cable Management — Vertical

Cord Management Cuff

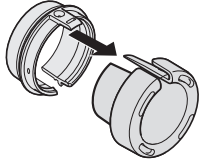

EUAC
Class YA – GSA: Open Market

Features

- Includes one bag of 26 - 2"(51mm) Cuffs or one bag of 50 - 1"(25mm) Cuffs.
- Product is applied to both ends of the separately specified Mesh Cord Manager and one end snaps into the Belong Wire Management Tray.

Specification Tips

- The size of the cuff aligns with the size of the Mesh Cord Wire Manager used.
- The Wire Management Tray can accept both the 1"(25mm) and 2"(51mm) cuff.
- Split cuff allows side insertion of cord or cable less than .5"(13mm) diameter. The shape or size of plug does not impede installation of cuff over cord cables.
- Available in charcoal TR-K only.
- Loom Insertion Tool Epart 2442-4401 is recommended for easier installation.

To Order, Specify:

- 1) Product number.
(No finish specification required.)

Description	Number	Price
1"(25mm) Bag of 50	EUAC-0001-C	\$230.34
2"(51mm) Bag of 26	EUAC-0002-C	184.27

Mesh Cord Manager with Cuffs

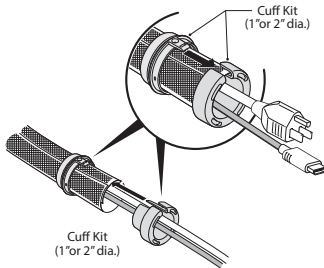

EUAW
Class YA – GSA: Open Market

Features

- Includes one bag of 26 - 2"(51mm) Cuffs or one bag of 50 - 1"(25mm) Cuffs and Cord Manager.
- Product is applied to both ends of the Mesh Cord Manager and one end snaps into the Belong Wire Management Tray.

Specification Tips

- The size of the Cuff aligns with the size of the Mesh Cord Wire Manager used.
- The Wire Management Tray can accept both the 1"(25mm) and 2"(51mm) Cuff.
- Available in grey, white or black.
- Loom Insertion Tool Epart 24424401 is recommended for easier installation.

To Order, Specify:

- 1) Product number.
(No finish specification required.)

Description	Number	Price
100'(30480mm) 1"(25mm) with 50 Cuffs	Grey	EUAW-A001-CG \$1164.86
	White	EUAW-A001-CW 1164.86
	Black	EUAW-A001-CB 1164.86
1"(25mm) with No Cuffs	Grey	EUAW-A001-NG 976.01
	White	EUAW-A001-NW 976.01
	Black	EUAW-A001-NB 976.01
50'(15240mm) 2"(51mm) with 26 Cuffs	Grey	EUAW-5002-CG \$1120.79
	White	EUAW-5002-CW 1120.79
	Black	EUAW-5002-CB 1120.79
2"(51mm) with No Cuffs	Grey	EUAW-5002-NG 976.01
	White	EUAW-5002-NW 976.01
	Black	EUAW-5002-NB 976.01

Mesh Cord Manager Bracket

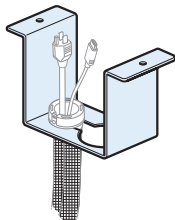

EUEA-CABR
Class YA – GSA: Open Market

Features

- Includes bracket and attachment hardware.
- Standard in black.

Specification Tips

- Designed to attach to the underside of a worksurface.
- For use with both 1"(25mm) and 2"(51mm) mesh cord manager with cuff.

To Order, Specify:

- 1) Product number.
(No finish specification required.)

Number	Price
EUEA-CABR	\$50.60

Cable Management — Vertical

Vertical Cord Manager — Metal

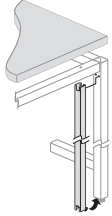

TYVW
Class CL – GSA: Open Market

Features

- Includes cord manager and attachment screws.

Specification Tips

- Order correct model for table height.
- Add additional Vertical Wire Channels if cord number exceeds three cords.
- Accommodates 2-3 cords/cables (depending on cable diameter) or one 0.5”(13mm) Flexible Conduit.

To Order, Specify:

- 1) Product number.
- 2) Trim color.

For Use With	Height	Width	Number	Trim	
				A	B
28”(711mm) Frame	25.7”(653mm)	1.17”(30mm)	TYVW-2601-P	\$122.89	\$129.66
40”(1016mm) Frame	37.7”(958mm)	1.17”(30mm)	TYVW-3801-P	128.84	138.71

Vertical Cable Guide

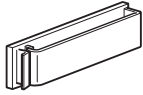

NECG-V
Class BC

Features

- Includes package of twelve cable guides.
- Manages communication cables.
- Self-adhesive back attaches to the top or bottom of horizontal surface.
- Standard in gray trim color only.

To Order, Specify:

- 1) Product number.
(No finish specification required.)

Height	Depth	Width	Number	Price
0.75”(19mm)	0.5”(13mm)	3”(76mm)	NECG-V	\$175.49

Vertical Cord Manager — Plastic

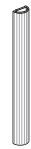

CPVC-1
Class RA

Features

- For channeling cords neatly on outside of any table base.
- Standard in black finish only.

To Order, Specify:

- 1) Product number.
(No finish specification required.)

Height	Depth	Width	Number	Price
26”(660mm)	0.5”(13mm)	1.18”(30mm)	CPVC-1	\$55.04

Height Adjustable Bench Cable Chain for Planes

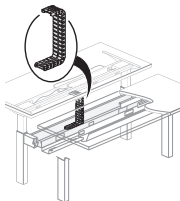

EAAW-0000-H
Class YA

Features

- Includes 36”(914mm) active length cable chain and mounting hardware.
- Color black only.
- Mounts to cable trough and underside of worksurface to contain power cords/data cables that are routed from the cable tray to the worksurface.

To Order, Specify:

- 1) Product number.
(No finish specification required.)

Specification Tips

- For use with Planes and Planes LT Benching.
- Holds up to three power cords and two data cables.

Height	Width	Actual Length	Installed Length	Number	Price
0.75”(19mm)	2.25”(57mm)	40”(1016mm)	36”(914mm)	EAAW-0000-H	\$350.02

Height Adjustable Bench Cable Chain for Upside

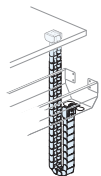

EUEA-CABC
Class YA

Features

- Includes 36”(914mm) active length cable chain and mounting hardware.
- Standard in black.
- Mounts from the underside of the power and data channel, routing power cords/data cables to the underside of worksurface.

To Order, Specify:

- 1) Product number.
(No finish specification required.)

Specification Tips

- For use with Upside Benching.
- Holds up to three power cords and two data cables.

Height	Width	Actual Length	Installed Length	Number	Price
0.75”(19mm)	2.25”(57mm)	40”(1016mm)	36”(914mm)	EUEA-CABC	\$427.90

Cable Management Accessories

Conduit Clamp

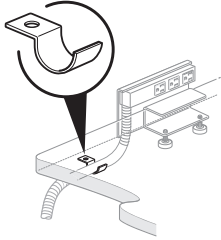

EUAM-0000
Class YA

Features

- Includes 25 clamps and 25 screws.
- For managing Power Tap cord or conduit under horizontal surfaces.

To Order, Specify:

- 1) Product number.
(No finish specification required.)

Number	Price
EUAM-0000	\$102.95

Cable Management Loop



NEH-8
Class YA

Features

- Includes box of eight cable management loops.
- Manages and stores cables through loops attached to horizontal surface.
- Threaded top allows installation anywhere under horizontal surfaces in recommended 18"(457mm) intervals.
- Wire management loop is 2"(51mm) in diameter with 3.1 sq. in.(2000mm²) of cross section area.
- Standard in charcoal trim color only.

To Order, Specify:

- 1) Product number.
(No finish specification required.)

Width	Installed Height	Number	Price
2.75"(70mm)	3.25"(83mm)	NEH-8	\$71.07

Cable Management Clips

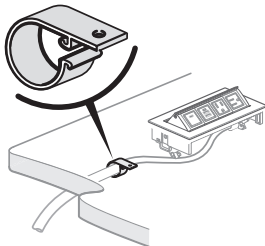

TA01-0225
Class TA

Features

- Includes ten cable manager clips and screws.
- Standard in black plastic.
- Field installed.

Specification Tips

- Specify for cord management as needed.

To Order, Specify:

- 1) Product number.
(No finish specification required.)

Number	Price
TA01-0225	\$35.17

Cable Management Accessories

Belong Hatch

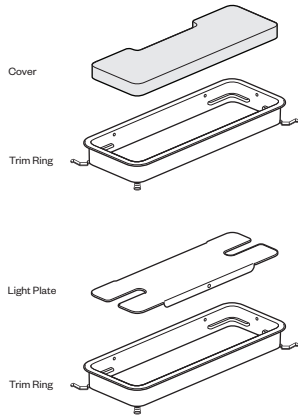

EUAH-0512
Class YA

Features

- Includes trim ring with tabs, cover or light plate.
- Available in two configurations: cover with trim ring or light plate with trim ring.
- Light plate configuration to be used with the separately specified Talia light located in the Ancillary Price List.
- Belong Hatch will sit flush with the worksurface and will always be centered on the worksurface with the exception of Upside Worksurface 90° Equal Corner - Wrap-Around or 90° Extended Corner-Wrap-Around which will be placed on the worksurface side with a partial understructure always.
- Trim ring is 12”(305mm)W and 5”(127mm)D.
- Available in two color choices of TR-K (Charcoal) or TR-FM (Snow).
- Trim ring and cover are plastic, light plate is painted steel.

Specification Tips

- Designed to work with Dual-Hinged Cable Management Tray — Metal (EUWT).
- Cannot be used on Planes Training or Collaborative tables due to interference with understructures.
- Can be placed on Adaptable Worksurfaces, Planes, Planes LT, Upside, Jive C-Leg, Jive T-Leg and Compose Echo. Each product has specification restrictions, reference product specification guide.
- Belong Hatch may be retrofitted to existing worksurfaces, (with a cut sheet), that do not interfere with the understructures.

To Order, Specify:

- 1) Product number.
- 2) Trim color.

Description	Number	Price
For use with 1.18”(30mm) worksurfaces		
Cover with trim ring	EUAH-0512-AYNNS	\$34.50
Light Plate with trim ring	EUAH-0512-ANNYS	74.75
For use with 2”(51mm) worksurfaces		
Cover with trim ring	EUAH-0512-AYNNM	\$34.50
Light Plate with trim ring	EUAH-0512-ANNYM	74.75

Cable Management Accessories

Belong Hatch Planning Guidelines

Product Line	Planes	Planes LT		Upside		Compose Echo	Adaptable Worksurface	Jive Tables	
Leg Style	C-Leg (2-leg and 3-leg)	C-Leg (2-leg and 3-leg)	T-Leg	C-Leg	T-Leg	L-Leg	N/A	C-Leg	T-Leg
Hatch Cutout Locations (From back edge of worksurface to center of hatch cutout)	9 1/8"	7 7/8"	6 1/2"	6 1 1/16"	6 1/2"	7"	6 3/4"	3 3/4"	7 1/2"
Wire Management Tray Location	Centered on Hatch	Centered on Hatch	Centered on Hatch	Centered on Hatch and frame rails	Centered on Hatch	Centered on Hatch	Centered on Hatch	Centered on Hatch	Centered on Hatch
⊘ Don't Widths that cannot accept Belong Hatch and Belong Wire Management Tray	46", 52" Wide	46" Wide	46" Wide	46", 52", 58" Wide Min 58", 64" for Hatch	Upside 2-Leg Rectangular 46", 52" Wide	46" Wide	24" Wide	For 24"D: 36", 42", 48", 54" Wide For 30"D: 36", 42", 48", 54" Wide (Flip Tops Not Allowed)	For 24"D: 36", 42", 48", 54" Wide For 30"D: 36", 42", 48", 54" Wide (Flip Tops Not Allowed)
Compose Echo Screens	All	All	All	All	All	Allowed	Allowed, must match the width of a convergent worksurface	Corner and Back Screens fit all worksurfaces sizes allowed.	Corner and Back Screens fit all worksurfaces sizes allowed.
Belong Screens	Allowed, but nominal width of screen must be 4" smaller than nominal width of Worksurface (ie 58W Worksurface needs 54W or smaller screen)	Allowed, but nominal width of screen must be 4" smaller than nominal width of Worksurface (ie 58W Worksurface needs 54W or smaller screen)	Allowed, but nominal width of screen must be 4" smaller than nominal width of Worksurface (ie 58W Worksurface needs 54W or smaller screen), 42W and 48W screens will not fit centered with tray in this location due to interference with tray mounting brackets	Nominal width of screen 2" smaller, per side, than nominal width of Worksurface (ie 58W Worksurface needs 54W or smaller screen).	Allowed, but nominal width of screen must be 2" smaller, per side, than nominal width of Worksurface (ie 58W Worksurface needs 54W or smaller screen), 42W and 48W screens will not fit centered with tray in this location due to interference with tray mounting brackets	54" or greater fits 30" base. Screens must be sized down from Worksurface size. Screen size cannot be greater than Worksurface size.	Allowed, to match the width of a convergent worksurface	Back Screens fit all worksurfaces sizes marked OK in column H	Back Screens fit all worksurfaces sizes marked OK in column H
Belong Plus Screens	Allowed, match width of worksurface	Allowed, match width of worksurface	Allowed, match width of worksurface	Allowed, match width of worksurface	Allowed, match width of worksurface	42" fits on 30" base. 30" fits on 22" base. Screens above 42" cannot be used with wireway. Screen size cannot be greater than Worksurface size.	Allowed, to match the width of a convergent worksurface	Back Screens fit all worksurfaces sizes marked OK in column H	Back Screens fit all worksurfaces sizes marked OK in column H
Planes Modesty Panel	54W and larger allowed, match width of worksurface, modesty nominal must be 4" smaller than nominal Worksurface width	54W and larger allowed, match width of worksurface, modesty nominal must be 4" smaller than nominal Worksurface width, 42W and 48W modestys will not fit centered with tray in this location	54W and larger allowed, match width of worksurface, modesty nominal must be 4" smaller than nominal Worksurface width, 42W and 48W modestys will not fit centered with tray in this location	54W and larger allowed, match width of worksurface, modesty nominal must be 4" smaller than nominal Worksurface width, 42W and 48W modestys will not fit centered with tray in this location	54W and larger allowed, modesty nominal must be 4" smaller than nominal Worksurface width, 42W and 48W screens will not fit centered with tray in this location	Not Allowed	Allowed to match the width of a convergent worksurface	Depths; 24" allowed, 30" Not Allowed	Widths: 60", 66", & 72" allowed All depths excluding 30" fit
Compose Echo Modesties	Not Allowed	Not Allowed	Not Allowed	Not Allowed	Not Allowed	Allowed	Not Allowed	Not Allowed	Not Allowed
Monitor Arms (Ergotron)	Clamp mount may be mounted to the left or right of the hatch without interference. If placing a grommet mount arm, please be aware of the understructure or mechanical components under the worksurface. If using a clamp style bracket, please refer to the usable space between the clamp and screens.	Clamp mount may be mounted to the left or right of the hatch without interference. If placing a grommet mount arm, please be aware of the understructure or mechanical components under the worksurface. If using a clamp style bracket, please refer to the usable space between the clamp and screens.	Clamp mount may be mounted to the left or right of the hatch without interference. If placing a grommet mount arm, please be aware of the understructure or mechanical components under the worksurface. If using a clamp style bracket, please refer to the usable space between the clamp and screens.	Clamp mount may be mounted to the left or right of the hatch without interference. If placing a grommet mount arm, please be aware of the understructure or mechanical components under the worksurface. If using a clamp style bracket, please refer to the usable space between the clamp and screens.	Clamp mount may be mounted to the left or right of the hatch without interference. If placing a grommet mount arm, please be aware of the understructure or mechanical components under the worksurface. If using a clamp style bracket, please refer to the usable space between the clamp and screens.	Clamp mount may be mounted to the left or right of the hatch without interference. If placing a grommet mount arm, please be aware of the understructure or mechanical components under the worksurface. If using a clamp style bracket, please refer to the usable space between the clamp and screens.	Clamp mount may be mounted to the left or right of the hatch without interference. If placing a grommet mount arm, please be aware of the understructure or mechanical components under the worksurface. If using a clamp style bracket, please refer to the usable space between the clamp and screens.	Clamp mount may be mounted to the left or right of the hatch without interference. If placing a grommet mount arm, please be aware of the understructure or mechanical components under the worksurface. If using a clamp style bracket, please refer to the usable space between the clamp and screens.	Clamp mount may be mounted to the left or right of the hatch without interference. If placing a grommet mount arm, please be aware of the understructure or mechanical components under the worksurface. If using a clamp style bracket, please refer to the usable space between the clamp and screens.

Cable Management Accessories

Grommets

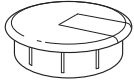

WUAC-WSG
Class CA

- Includes one grommet with removable cover.
- Must be field-installed.
- Available in black color only.

Specification Tips

- Works with top thickness 1" or greater.

To Order, Specify:

- 1) Product number.
(No finish specification required.)

Outside

Diameter	Height	Hole Size	Number	Price
3"(76mm)	1"(25mm)	2.75"(70mm)	WUAC-WSG	\$41.27



WQAG
Class IN

Features

- Includes one painted grommet with removable cover.
- Must be field-installed.

Specification Tips

- Works with top thickness:
 - WQAG-0303-PS - 1.18"(30mm) or greater
 - WQAG-0303-PM - 2"(51mm) or greater

To Order, Specify:

- 1) Product number.
- 2) Trim color.

Outside

Diameter	Height	Hole Size	Number	Trim	
				A	B
3"(76mm)	1.125"(29mm)	2.75"(70mm)	WQAG-0303-PS	\$68.40	\$82.44
3"(76mm)	2"(51mm)	2.75"(70mm)	WQAG-0303-PM	68.40	82.44



JAG-1
Class TA

- Includes one grommet with removable cover.
- Must be field-installed.
- Available in black color only.
- Works with top thickness 0.75" or greater.

To Order, Specify:

- 1) Product number.
(No finish specification required.)

Outside

Diameter	Height	Hole Size	Number	Price
2"(51mm)	0.75"(19mm)	1.75"(44mm)	JAG-1	\$33.59
3.5"(89mm)	0.75"(19mm)	3"(76mm)	JAG-2	38.74



JAG-2
Class TA



TA01-0220
Class TA

Features

- Includes one painted grommet.
- Must be field-installed.

Specification Tips

- Works with 0.75" top or greater.

To Order, Specify:

- 1) Product number.
- 2) Trim color.

Outside

Diameter	Height	Hole Size	Number	Trim	
				A	B
3"(76mm)	0.72"(18mm)	2.75"(70mm)	TA01-0220	\$57.00	\$65.31

Cable Management Accessories

Grommets

Flip Top Unit — Hatch

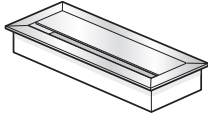

EUG1
Class TA

Features

- Includes one flip top unit hatch.
- Hatch is flush mounted with spring release cover; 0.5”(13mm) gap between cover and bezel for cords.
- Available in anodized or black finish.
- Field installed.

Specification Tips

- Specify for cord management as needed.
- Order hatch to match cutouts specified for each table.

To Order, Specify:

- 1) Product number.
(No finish specification required.)

Bezel Width	Bezel Depth	Flip Top Unit Cutout Code	Configuration	Number	Price
Anodized					
5.24”(133mm)	4.375”(111mm)	A, B	2	EUG1-0000-G2NNNW	\$285.44
8.31”(211mm)		F, V	4	EUG1-0000-G4NNNW	303.28
11.25”(286mm)		J, K	6	EUG1-0000-G6NNNW	321.14
Black					
5.24”(133mm)	4.375”(111mm)	A, B	2	EUG1-0000-G2NNNB	\$ 374.65
8.31”(211mm)		F, V	4	EUG1-0000-G4NNNB	392.49
11.25”(286mm)		J, K	6	EUG1-0000-G6NNNB	410.35

Electrical Accessories Resources

Surfaces Materials

Index

Warranty

Surface Materials

Finish Color Legend

Trim

Grade A

Smooth

TR-R	Beige
TR-AK	Chalk
TR-K	Charcoal
TR-C1	Cocoa
TR-J	Graphite
TR-G	Gray Tone
TR-AA	Putty
TR-E	Smoke
TR-PLS	Smooth Plaster
TR-FM	Snow

Textured

TR-TG	Grout
TR-TF	Pitch
TR-TW	Plaster

Grade B

Smooth

TR-1C	Accent Blue
TR-1G	Blue Jay
TR-1R	Brownstone
TR-1N	Night
TR-1Q	Park
TR-RR	Rusty Red
TR-1M	Sable
TR-1J	Sky Blue

Smooth Metallic

TR-MC	Metallic Champagne
TR-MG	Metallic Gunmetal
TR-LE	Metallic Silver

Textured Metallic

TR-AR	Argent
TR-HE	Hellenic

ALERT: These materials are current, however they are being considered for future obsolescence due to low volume.

Trims

TR-1E	Accent Orange
TR-1F	Accent Red
TR-CTS	Chartreuse
TR-1H	Terra
TR-1K	Wren

Index

Products are listed alphabetically in this index by alpha-numeric prefix/suffix codes.

Product Code	Product Description	Page
4TJC-72	Cable Management — Horizontal — 72" J-Channel Cable Manager — Plastic	.97
AKWN	Cable Management — Horizontal — Cable Management Channel — PET	.96
CPVC-1	Cable Management — Vertical — Vertical Cord Manager — Plastic	.99
EAAB-0000-H	Cable Management — Vertical — Height Adjustable Bench Cable Chain for Planes	.99
EDUX-3000-B	Worksurface Power Modules — Other Power and Data — Retrofit USB Charging Cable	.93
EUAC	Cable Management — Vertical — Cord Management Cuff	.98
EUAH-0512	Cable Management Accessories — Belong Hatch	.101
EUAM-0000	Cable Management Accessories — Conduit Clamp	.100
EUAW	Cable Management — Vertical — Mesh Cord Manager with Cuffs	.98
EUAW-NH	Cable Management — Horizontal — Fixed Cable Management Tray — Metal	.96
EBU1-HLOB-2100	Worksurface Power Modules — Flush Mounted Power — Hardwire	.77
EBU1-HLOB-2110	Worksurface Power Modules — Flush Mounted Power — Hardwire	.77
EBU1-HLOB-2112	Worksurface Power Modules — Flush Mounted Power — Hardwire	.77
EBU1-PL0B-2100	Worksurface Power Modules — Flush Mounted Power — Corded	.74
EBU1-PL0B-2110	Worksurface Power Modules — Flush Mounted Power — Corded	.74
EBU1-PL0B-2112	Worksurface Power Modules — Flush Mounted Power — Corded	.74
EBU1-PL0B-4000	Worksurface Power Modules — Flush Mounted Power — Corded	.74
EBU1-SF0B-2100	Worksurface Power Modules — Flush Mounted Power — Spiral Cord for Height Adjustable	.80
EBU1-SF0B-2110	Worksurface Power Modules — Flush Mounted Power — Spiral Cord for Height Adjustable	.80
EBU1-SF0B-2112	Worksurface Power Modules — Flush Mounted Power — Spiral Cord for Height Adjustable	.80
EBU1-SF0B-4000	Worksurface Power Modules — Flush Mounted Power — Spiral Cord for Height Adjustable	.80
EBU1-SLOB-2100	Worksurface Power Modules — Flush Mounted Power — Worksurface Power Modules—Flush Mounted Power	.83
EBU1-SLOB-2110	Worksurface Power Modules — Flush Mounted Power — Worksurface Power Modules—Flush Mounted Power	.83
EBU1-SLOB-2112	Worksurface Power Modules — Flush Mounted Power — Worksurface Power Modules—Flush Mounted Power	.83
EBU1-SLOB-4000	Worksurface Power Modules — Flush Mounted Power — Worksurface Power Modules—Flush Mounted Power	.83
EBU5	Worksurface Power Modules — Belong — Power Suite	.17
EBU5-BIN1	Worksurface Power Modules — Belong Power 65W — Power Suite	.15
ECU1-HF0P-200000	Worksurface Power Modules — Flip Top — Smooth Bezel — Hardwire — Single-Sided — Power, Data and USB	.46
ECU1-HF0P-210010	Worksurface Power Modules — Flip Top — Smooth Bezel — Hardwire — Single-Sided — Power, Data and USB	.46
ECU1-HF0P-311010	Worksurface Power Modules — Flip Top — Smooth Bezel — Hardwire — Single-Sided — Power, Data and USB	.46
ECU1-PF0P-200000	Worksurface Power Modules — Flip Top — Smooth Bezel — Corded — Single-Sided — Power, Data and USB	.40
ECU1-PF0P-210010	Worksurface Power Modules — Flip Top — Smooth Bezel — Corded — Single-Sided — Power, Data and USB	.40
ECU1-PF0P-311010	Worksurface Power Modules — Flip Top — Smooth Bezel — Corded — Single-Sided — Power, Data and USB	.40
ECU1-PF0P-400000	Worksurface Power Modules — Flip Top — Smooth Bezel — Corded — Single-Sided — Power, Data and USB	.40
ECU2-HF0P-210010	Worksurface Power Modules — Flip Top — Smooth Bezel — Hardwire — Double-Sided — Power, Data and USB	.49
ECU2-HF0P-311010	Worksurface Power Modules — Flip Top — Smooth Bezel — Hardwire — Double-Sided — Power, Data and USB	.49
ECU2-PF0P-210010	Worksurface Power Modules — Flip Top — Smooth Bezel — Corded — Double-Sided — Power, Data and USB	.43
ECU2-PF0P-311010	Worksurface Power Modules — Flip Top — Smooth Bezel — Corded — Double-Sided — Power, Data and USB	.43
ECU2-PF0P-400000	Worksurface Power Modules — Flip Top — Smooth Bezel — Corded — Double-Sided — Power, Data and USB	.43
ECU4	Worksurface Power Modules — Power Cube	.17
ECU4-BIN1	Worksurface Power Module — Belong Power 65W — Power Cube	.14
ECUB-TJP	Worksurface Power Modules — Power Cube and Power Suite — Brackets	.18
ECUB-WFP	Worksurface Power Modules — Power Cube and Power Suite — Brackets	.18
ECUB-WJP	Worksurface Power Modules — Power Cube and Power Suite — Brackets	.18
ECUN-PJ	Worksurface Power Modules — Other Power and Data — Collaborative Power Station	.92
EUD1-HF0B-2010	Worksurface Power Modules — Enhanced Power — Hardwire	.28
EUD1-HF0B-2110	Worksurface Power Modules — Enhanced Power — Hardwire	.28
EUD1-HF0B-2112	Worksurface Power Modules — Enhanced Power — Hardwire	.28
EUD1-PF0B-2010	Worksurface Power Modules — Enhanced Power — Corded	.23
EUD1-PF0B-2110	Worksurface Power Modules — Enhanced Power — Corded	.23
EUD1-PF0B-2112	Worksurface Power Modules — Enhanced Power — Corded	.23

Index

Product Code	Product Description	Page
EUD1-PFOB-4000	Worksurface Power Modules — Enhanced Power — Corded	.23
EUD1-SFOB-2110	Worksurface Power Modules — Enhanced Power — Spiral Corded — Height Adjustable	.33
EUD1-SFOB-4000	Worksurface Power Modules — Enhanced Power — Spiral Corded — Height Adjustable	.33
EUD1-SLOB-2110	Worksurface Power Modules — Enhanced Power — Cord for Height Adjustable	.34
EUD1-SLOB-4000	Worksurface Power Modules — Enhanced Power — Cord for Height Adjustable	.34
EUDB-0000-H	Worksurface Power Modules — Enhanced Power — Brackets — Above Worksurface — Adjustable	.35
EUDB-0000-N	Worksurface Power Modules — Enhanced Power — Brackets — Above Worksurface — Adjustable for Knife Edge	.35
EUDB-0000-T	Worksurface Power Modules — Enhanced Power — Brackets — Above Worksurface — Adjustable with Tackboard Offset	.36
EUDB-0000-U	Worksurface Power Modules — Enhanced Power — Brackets — Under Worksurface — Fixed	.37
EUDB-0000-W	Worksurface Power Modules — Enhanced Power — Brackets — Above Worksurface — Fixed	.36
EUDB-J	Worksurface Power Modules — Enhanced Power — Brackets — For Use with X Series	.37
EUDX-3000-B	Worksurface Power Modules — Other Power and Data — Cables	.93
EUDX-H000-B	Worksurface Power Modules — Other Power and Data — Cables	.93
EUDX-V000-B	Worksurface Power Modules — Other Power and Data — Cables	.93
EUE1-000B	Worksurface Power Modules — Flip Top — Non-Powered	.53
EUE1-1111W	Worksurface Power Modules — Flip Top — Power and Data	.52
EUE1-1331W	Worksurface Power Modules — Flip Top — Power and Data	.52
EUE1-C331W	Worksurface Power Modules — Flip Top — Power and Data	.52
EUE1-HFOB-1212	Worksurface Power Modules — Flip Top — Hardwire — Single-Sided — Power, Data and USB	.64
EUE1-HFOB-2110	Worksurface Power Modules — Flip Top — Hardwire — Single-Sided — Power, Data and USB	.64
EUE1-PFOB-1212	Worksurface Power Modules — Flip Top — Corded — Single-Sided — Power, Data and USB	.54
EUE1-PFOB-2110	Worksurface Power Modules — Flip Top — Corded — Single-Sided — Power, Data and USB	.54
EUE1-PFOB-4000	Worksurface Power Modules — Flip Top — Corded — Single-Sided — Power, Data and USB	.54
EUE2-000B	Worksurface Power Modules — Flip Top — Non-Powered	.53
EUE2-1331W	Worksurface Power Modules — Flip Top — Power and Data	.52
EUE2-C331W	Worksurface Power Modules — Flip Top — Power and Data	.52
EUE2-HFOB-2110	Worksurface Power Modules — Flip Top — Hardwire — Double-Sided — Power, Data and USB	.69
EUE2-HFOB-1212	Worksurface Power Modules — Flip Top — Hardwire — Double-Sided — Power, Data and USB	.69
EUE2-PFOB-1212	Worksurface Power Modules — Flip Top — Corded — Double-Sided — Power, Data and USB	.59
EUE2-PFOB-2110	Worksurface Power Modules — Flip Top — Corded — Double-Sided — Power, Data and USB	.59
EUE2-PFOB-4000	Worksurface Power Modules — Flip Top — Corded — Double-Sided — Power, Data and USB	.59
EUEA-CABC	Cable Management — Vertical — Height Adjustable Bench Cable Chain for Upside	.99
EUEA-CABR	Cable Management — Vertical — Mesh Cord Manager Bracket	.98
EUET-0000-1M3N	Worksurface Power Modules — Power Tap — Hardwire and Corded — Corded	.89
EUET-0030-2M3N	Worksurface Power Modules — Power Tap — Horizontal	.87
EUET-0030-3M3N	Worksurface Power Modules — Power Tap — Horizontal	.87
EUET-0030-4M3N	Worksurface Power Modules — Power Tap — Horizontal	.87
EUET-0030-CM3N	Worksurface Power Modules — Power Tap — Hardwire and Corded — Hardwire	.89
EUF1-PFOB	Worksurface Power Modules — Classic Power — Classic Power Module	.38
EUFB-0000-AB	Worksurface Power Modules — Classic Power — Brackets — Angled	.39
EUFB-0000-SB	Worksurface Power Modules — Classic Power — Brackets — Vertical	.39
EUFB-0000-UB	Worksurface Power Modules — Classic Power — Brackets — Under Surface	.39
EUG1	Cable Management Accessories — Grommets — Flip Top Unit — Hatch	.104
EUP1-HF	Worksurface Power Modules — Flush Mounted Power — Round	.86
EUP1-PF	Worksurface Power Modules — Flush Mounted Power — Round	.86
EUPB-TJP	Worksurface Power Modules — Belong Power 65W — Plug Strip Brackets	.16
EUPB-WFP	Worksurface Power Modules — Belong Power 65W — Plug Strip Brackets	.16
EUPB-WJP	Worksurface Power Modules — Belong Power 65W — Plug Strip Brackets	.16
EUR1	Worksurface Power Modules — Belong — Plug Strip	.17
EUR1-BIN1	Worksurface Power Module — Belong Power 65W — Plug Strip	.14
EURT-0000-N001CB	Worksurface Power Modules — Other Power and Data — Data Bezel	.91

Index

Product Code	Product Description	Page
EURT-0000-N001CB	Worksurface Power Modules — Other Power and Data — Data Bezel91
EURT-0000-N001CW	Worksurface Power Modules — Other Power and Data — Data Bezel91
EURT-0000-N001SW	Worksurface Power Modules — Other Power and Data — Data Bezel91
EURT-0072-1010	Worksurface Power Modules — Other Power and Data — Bezel Utility Module91
EURT-0072-1100	Worksurface Power Modules — Other Power and Data — Bezel Utility Module91
EUS1-HLOB	Worksurface Power Modules — Enhanced Power — Seamless20
EUS1-HLOW	Worksurface Power Modules — Enhanced Power — Seamless20
EUS1-PFOB	Worksurface Power Modules — Enhanced Power — Seamless20
EUUB-UP	Worksurface Power Modules — Power Cube and Power Suite — Brackets18
EUWC-HLOB	Worksurface Power Modules — Wireless Charging Module19
EUWC-HLOW	Worksurface Power Modules — Wireless Charging Module19
EUWC-PFOB	Worksurface Power Modules — Wireless Charging Module19
EUWC-PFOW	Worksurface Power Modules — Wireless Charging Module19
EUWT	Cable Management — Horizontal — Dual-Hinged Cable Management Tray — Metal95
JAG-1	Cable Management Accessories — Grommets103
JAG-2	Cable Management Accessories — Grommets103
NECG-V	Cable Management — Vertical — Vertical Cable Guide99
NEH-8	Cable Management Accessories — Cable Management Loop100
TA01-0220	Cable Management Accessories — Grommets103
TA01-0225	Cable Management Accessories — Cable Management Clips100
TABC	Cable Management — Horizontal — Cover for Cable Management Basket — Metal96
TAWB	Cable Management — Horizontal — Cable Management Basket — Metal96
TYVW	Cable Management — Vertical — Vertical Cord Manager — Metal99
WQAG	Cable Management Accessories — Grommets103
WUAC-WSG	Cable Management Accessories — Grommets103
WUAW-PNH	Cable Management — Horizontal — 15" Mini J-Channel Cable Manager — Plastic97
ZUAP-0000-PAN	Worksurface Power Modules — Power Tap — Brackets — Adjustable90
ZUAP-0000-PFD	Worksurface Power Modules — Power Tap — Brackets — Fixed90
ZUAP-0000-PGH	Worksurface Power Modules — Power Tap — Brackets — Bracket with Grommet90
ZUAP-000-PUR	Worksurface Power Modules — Power Tap — Brackets — Under Surface90

Product Compatibility and Limited Warranty Policy

Great Expectations

You have them as a Haworth customer and so do we. And because we value our customers, we cover our products with the Haworth North America Product Compatibility and Limited Warranty Policy.

Our Commitment To Product Compatibility – Integrated Product Platforms

As a market leader in the design and manufacture of workspaces that adapt to change, we strive to maintain product compatibility within our various generations of integrated product platforms. This benefits the customer who desires to update or modify their work environment. It also benefits the customer needing to replace a product due to damage or other reasons but which is no longer manufactured or is otherwise unavailable, such as a fabric or finish that is discontinued because of changing market preferences. In both circumstances, we often can provide products with comparable function and performance.

Our Commitment To Product Quality – The Haworth North America Limited Warranty

To ensure customer satisfaction and peace of mind, we stand behind our products with the Haworth North America Limited Warranty. To review the current version of the limited warranty including its terms and conditions, please go to:

www.haworth.com/warranty or contact OneTouch@Haworth.com or 1 877 429 6784.

Warranty Requests or Questions

For questions or service requests pertaining to the Haworth Limited Warranty, please contact your Haworth dealer.

If you are unsure who your dealer is, please contact **OneTouch@Haworth.com or 1 877 429 6784.**

Terms of Sale

The Terms of Sale apply to all products in the North America Price Lists. To review the current version of the North American Terms of Sale, please go to:

www.haworth.com/terms-of-sale or contact OneTouch@Haworth.com or 1 877 429 6784.

HAWORTH

HAWORTH® is a registered trademark of Haworth, Inc.
© Haworth, Inc. All rights reserved. 2026 2.26
haworth.com | 800 344 2600