

Haworth Gallerie

North America Price List – March 2026





This Haworth North American price book contains US list prices.

Canadian customers can convert the US list price into their Canadian equivalent by going to www.Haworth.com/Canada to find the current Canadian multipliers. These multiplier factors allow you to convert the US list price into a Canadian list price.



This Page Intentionally Left Blank

Haworth Gallerie Price List

Includes pricing, catalog numbers, finish codes/availability, specification requirements, line art, dimensions, and specification tips for Haworth Gallerie.

Panel to Panel Face Attachment

Worksurface Support

Panel Accessories

Power and Data Management

Electrical Components

Cable Management

Modular Lower Storage Tops

Credenza Tops

Lateral File Tops

Table of Contents

Price List

Statement of Line	7
Haworth Gallerie	
Catalog Logic	12
Panels with Two Half Face Connection options (J,K)	13
Panels with Half Face Connection options (P,U,D)	14
Panels with Half Face Connection options (I,S,M)	15
Panel to Panel Face Attachment	
L/R (Left or Right Mount)	18
W/E (Half Left or Half Right Mount)	20
C (Center Mount)	23
K/J (Left or Right Full Face Connection Mount with Half Mount)	25
P (Half Left and Half Right Mount)	28
U (Left and Right Mounts)	30
T (Two-Sided Left/Right Mount)	32
H (Two-Sided Half Left/Right Mount)	34
X (Two-Sided Center Mount)	36
D (Two-Sided Half Left and Half Right Mount)	38
I (90° Face Connection)	38
S (Straight In-Line Add-On)	42
M (End Connector)	44
Worksurface Support	
Worksurface Support Panel	46
Panel Accessories	
Panel Attachment Bracket	47
Tie Plate	47
Glass Topper — Panel Mounting	48
Topper Holder Kit	50
Insert Glass — Panel Glass Ready Option	51
Panel Hanging Brackets	53
Height Adjustable Table Tie	54
Connection Conversion Kit	54
Glass Channel Filler	54
Power and Data Management	
Power Console — Core	56
Power Console — Access Hatch	57
Power Console — Laminate Front	58
Power Console — Trough	60
Power Console — End Trim	60
Filler Trim — Variable — Vertical	61
Filler Trim — Horizontal	61
Electrical Components	
Infeed Module Stacking — DualCircuit — Hardwire Connection	62
Top Feed Pole for Gallerie	62
Concealed Base Feed Module — Hardwire Connection — Connections and Beam	63
Single Circuit Base Feed Module — Receptacle Connection with Power Cord (USA Only)	63
Single Circuit Base Feed Module — Receptacle Connection with Power Cord (Canada Only)	63
Power Distribution Assembly Kit	64
Flexible Power Connector — DualCircuit	65
Conduit Jumper — DualCircuit	65
Receptacle — 15 Amp	66
Receptacle Data Kit	67
Receptacle and Data Blank Cover (DualCircuit)	67
Cable Management — Vertical	
Gallerie Power Console Cable Chain	68
Grommets	68
Power Break Marker	68
Conduit Clamp	68
Cable Management — Horizontal	
Dual-Hinged Cable Management Tray — Application Chart	69
Dual-Hinged Cable Management Tray — Metal	70
Cable Management — Vertical	
Cord Management Cuff	71
Mesh Cord Manager with Cuffs	71
Mesh Cord Manager Bracket	71

Be_Hold Modular Lower Storage Tops	
Common Top	72
Pedestal Top	76
Filing and Storage Top	77
Modular Lower Storage Tops	
Be_Hold Be 1.5H Height Adjustable Table Storage Top - Laminate - 0.75" Thick — HAT Storage Top	78
Be_Hold Be 2H Storage Tops - Laminate - 1.18" Thick — Pedestal Top	79
2H Storage Tops - Laminate - 1.18" Thick — Filing and Storage Top	79
Be_Hold Be Common Top - Laminate - 1.18" Thick — Common Top	80
Credenza Tops	
X Series Credenza Top	82
Lateral File Tops	
X Series Laminate for use with Proud Style Fronts — File Top	83
Laminate for use with Proud Style Fronts — Common File Top	83
X Series Wood for use with Proud Style Fronts — File Top	84
Wood for use with Proud Style Fronts — Common File Top	84
X Series Laminate for use with Inset Style Fronts — File Top	85
Laminate for use with Inset Style Fronts — Common File Top	85
X Series Wood for use with Inset Style Fronts — File Top	86
Wood for use with Inset Style Fronts — Common File Top	86
Finishes	
Finish/Color Legend	88
Index	89-90
Lifetime Product Warranty	91

Statement of Line

Panel to Panel Face Attachment

Pages 18-39

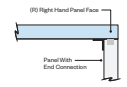
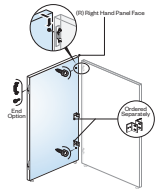
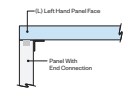
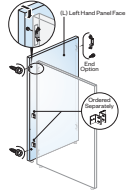

L/R (Left or Right Mount)

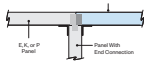
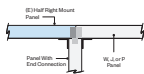
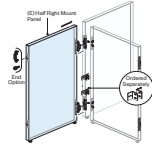

W/E (Half Left or Half Right Mount)

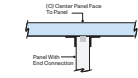
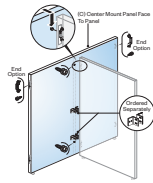

C (Center Mount)

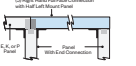
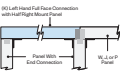
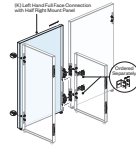

K/J (Left or Right Full Face Connection Mount with Half Mount)

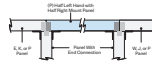
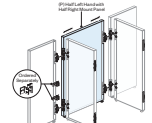

P (Half Left and Half Right Mount)

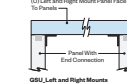
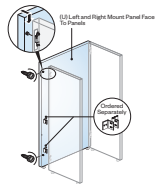
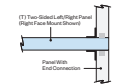
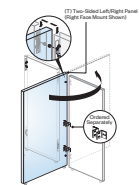
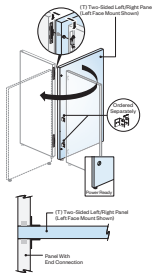

U (Left and Right Mounts)

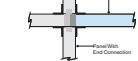
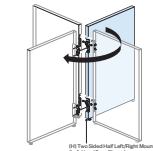
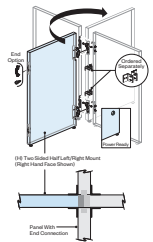

H (Two-Sided Half Left/Right Mount)

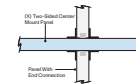
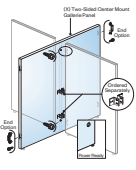

X (Two-Sided Center Mount)

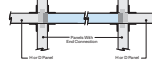
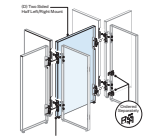

D (Two-Sided Half Left and Half Right Mount)

Statement of Line

Panel to Panel End Attachment (cont'd)

Pages 40-45

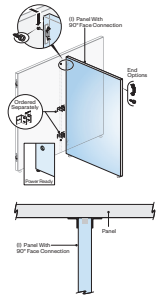

I (90° Face Connection)

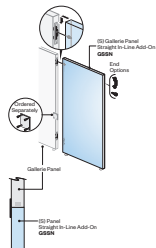

S (Straight In-Line Add-On)

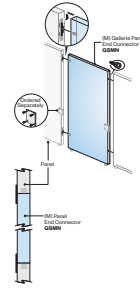

M (End Connector)

Worksurface Support

Page 46

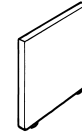

Edgeband



Knife



Architectural Wall, Compose Gallery Panel or Gallerie

Panel Accessories

Pages 47-54

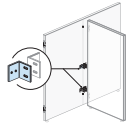

Panel Attachment Bracket

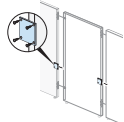
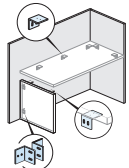

Tie Plate

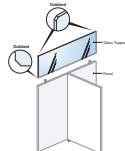

Glass Topper — Panel Mounting

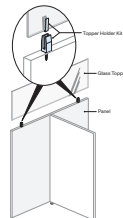

Topper Holder Kit

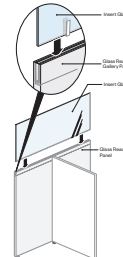

Insert Glass — Panel Glass Ready Option

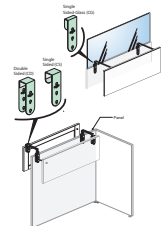

Panel Hanging Brackets

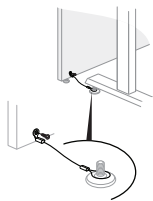

Height Adjustable Table Tie

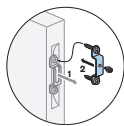

Connection Conversion Kit

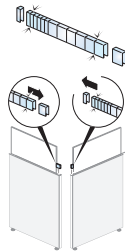

Glass Channel Filler

Statement of Line

Power and Data Management

Pages 56-61

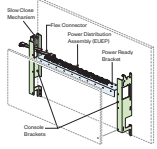

Power Console — Core

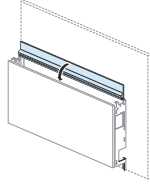

Power Console — Access Hatch

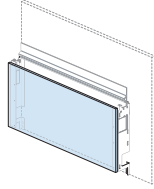

Power Console — Laminate Front

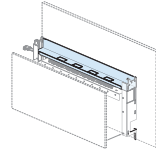

Power Console — Trough

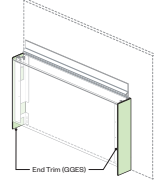

Power Console — End Trim

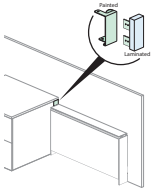

Filler Trim — Variable — Vertical

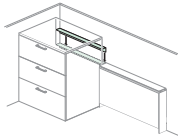

Filler Trim — Horizontal

Electrical Components

Pages 62-67

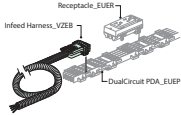

Infeed Module Stacking — DualCircuit — Hardware Connection

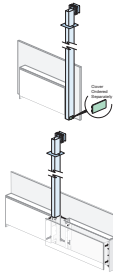

Top Feed Pole for Gallerie

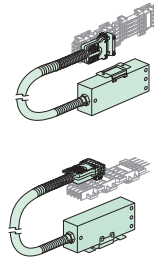

Concealed Base Feed Module — Hardware Connection — Connections and Beam

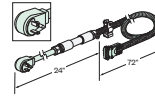

Single Circuit Base Feed Module — Receptacle Connection with Power Cord (USA Only)

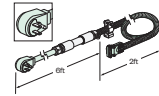

Single Circuit Base Feed Module — Receptacle Connection with Power Cord (Canada Only)

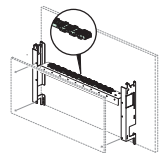

Power Distribution Assembly Kit

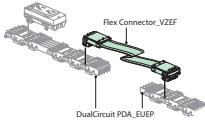

Flexible Power Connector — DualCircuit

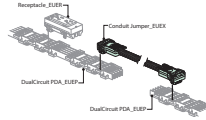

Conduit Jumper — DualCircuit

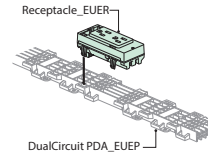

Receptacle — 15 Amp

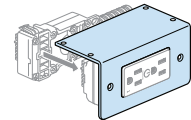

Receptacle Data Kit

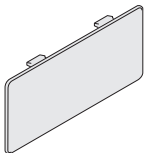

Receptacle and Data Blank Cover (DualCircuit)

Statement of Line

Cable Management — Vertical

Page 68

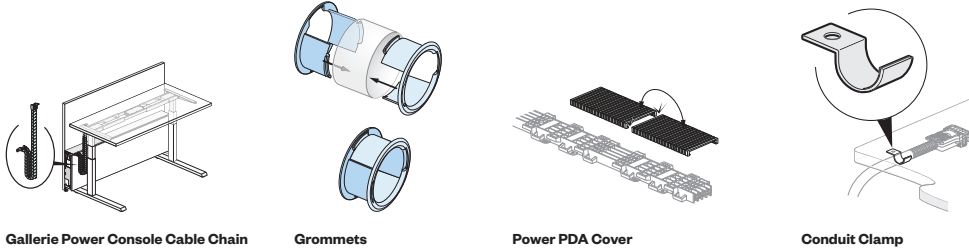

Gallerie Power Console Cable Chain

Grommets

Power PDA Cover

Conduit Clamp

Cable Management — Horizontal

Page 70

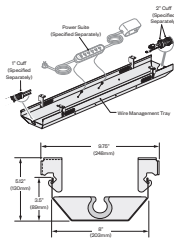

Dual-Hinged Cable Management Tray — Metal

Cable Management — Vertical

Page 71

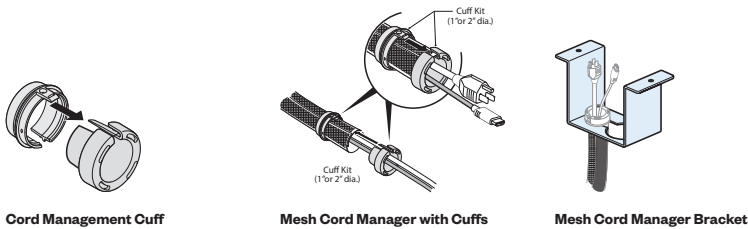

Cord Management Cuff

Mesh Cord Manager with Cuffs

Mesh Cord Manager Bracket

Be_Hold Modular Lower Storage Tops

Pages 72-77

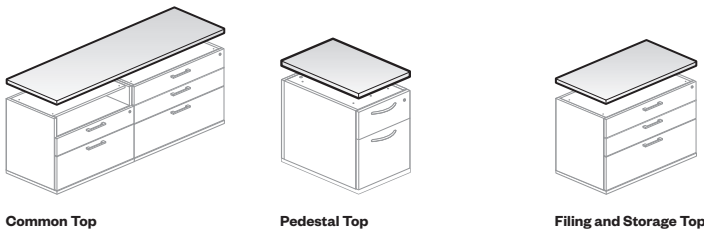

Common Top

Pedestal Top

Filing and Storage Top

Statement of Line

Modular Lower Storage Tops (cont'd)

Pages 78-80

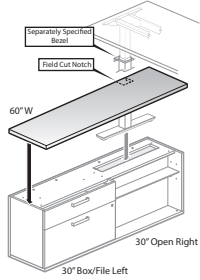

Be_Hold Be 1.5H Height Adjustable Table Storage Top - Laminate - 0.75" Thick — HAT Storage Top

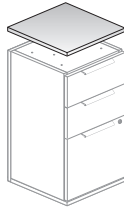

Be_Hold Be 2H Storage Tops - Laminate - 1.18" Thick — Pedestal Top



Be_Hold Be 2H Storage Tops - Laminate - 1.18" Thick — Filing and Storage Top

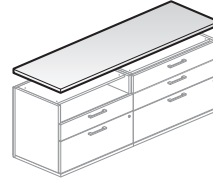

Be_Hold Be Common Top - Laminate - 1.18" Thick — Common Top

Credenza Tops

Page 82

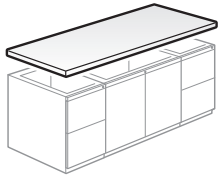

X Series Credenza Top

Lateral File Tops

Pages 83-86



X Series Laminate for use with Proud Style Fronts — File Top



Laminate for use with Proud Style Fronts — Common File Top

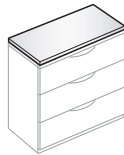

X Series Wood for use with Proud Style Fronts — File Top

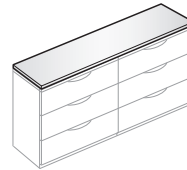

Wood for use with Proud Style Fronts — Common File Top



X Series Laminate for use with Inset Style Fronts — File Top

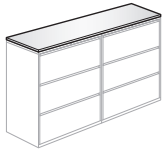

Laminate for use with Inset Style Fronts — Common File Top



X Series Wood for use with Inset Style Fronts — File Top



Wood for use with Inset Style Fronts — Common File Top

Haworth Gallerie

Panels with Single Face Connection options (C,L,R,W,E,T,H,X)

Catalog Logic

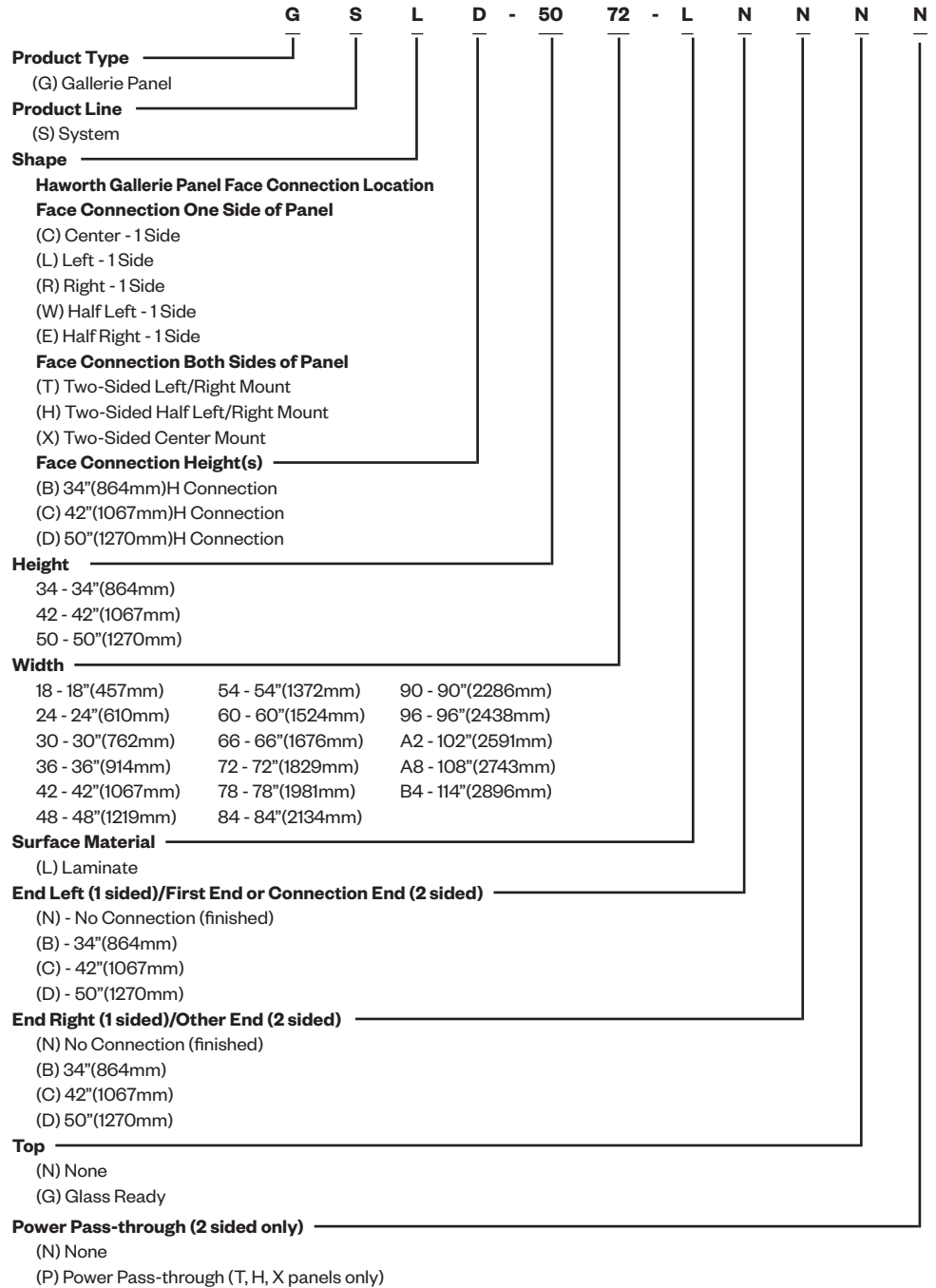

Haworth Gallerie

Panels with Two Half Face Connection options (J,K)

Catalog Logic

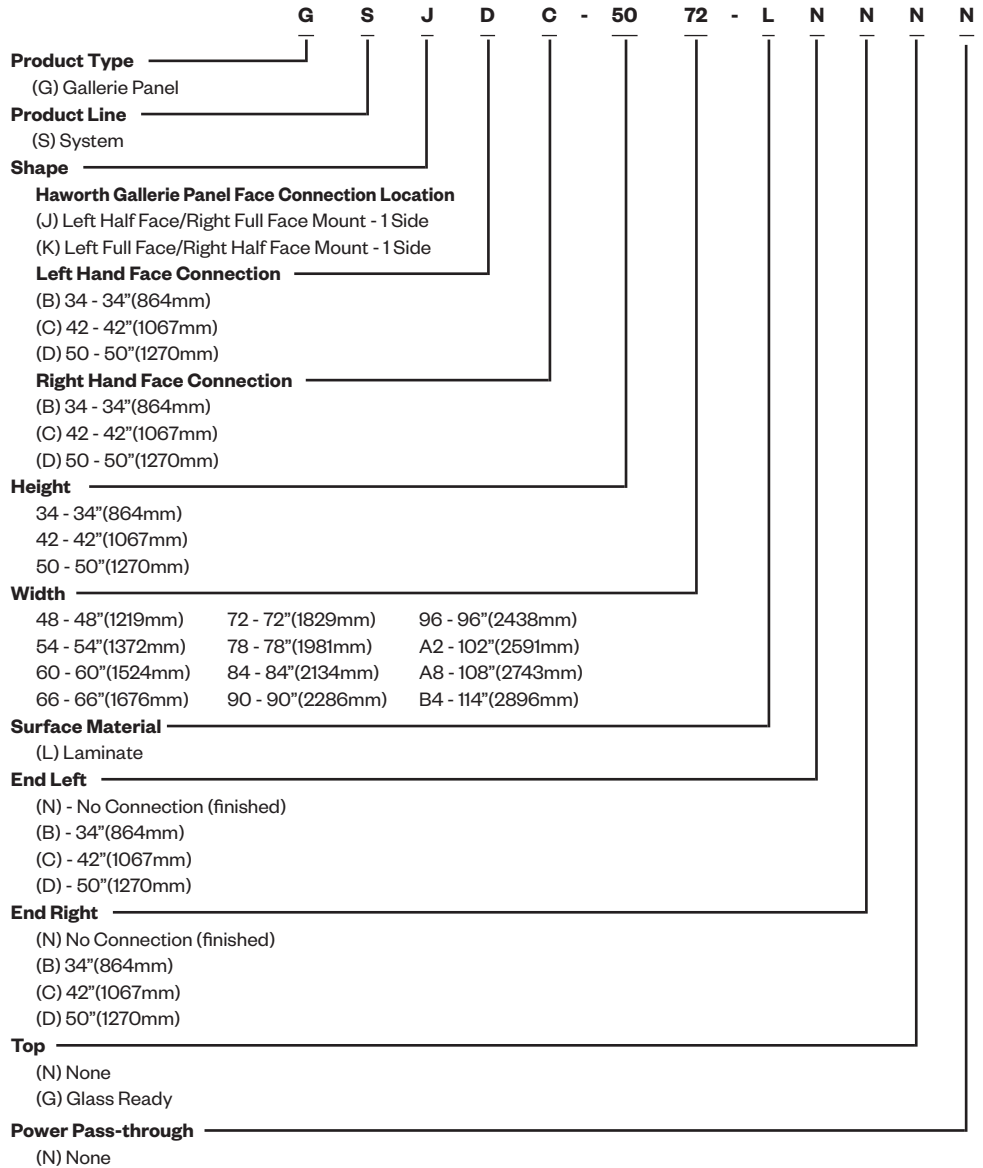

Haworth Gallerie

Panels with Half Face Connection options (P,U,D)

Catalog Logic

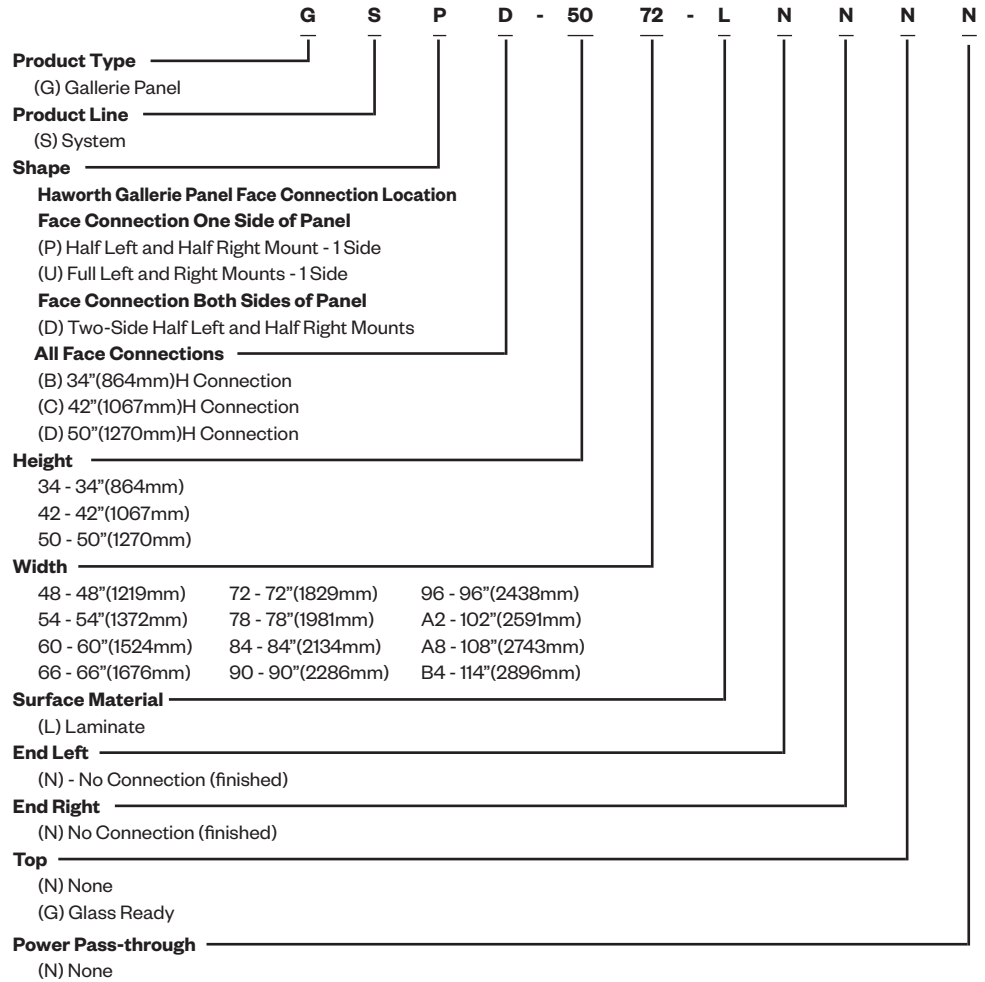

Haworth Gallerie

Panels with No Face Connection options (I,S,M)

Catalog Logic

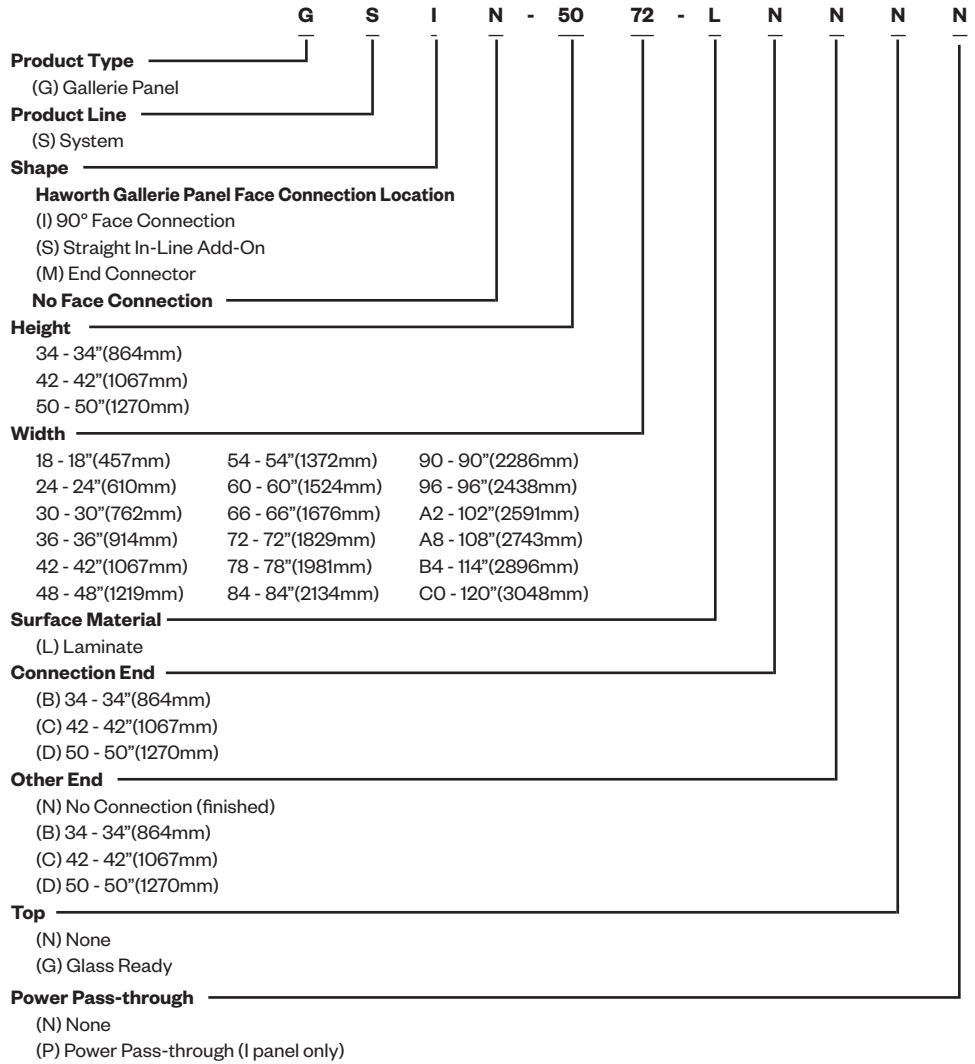

Haworth Gallerie

At-a-Glance

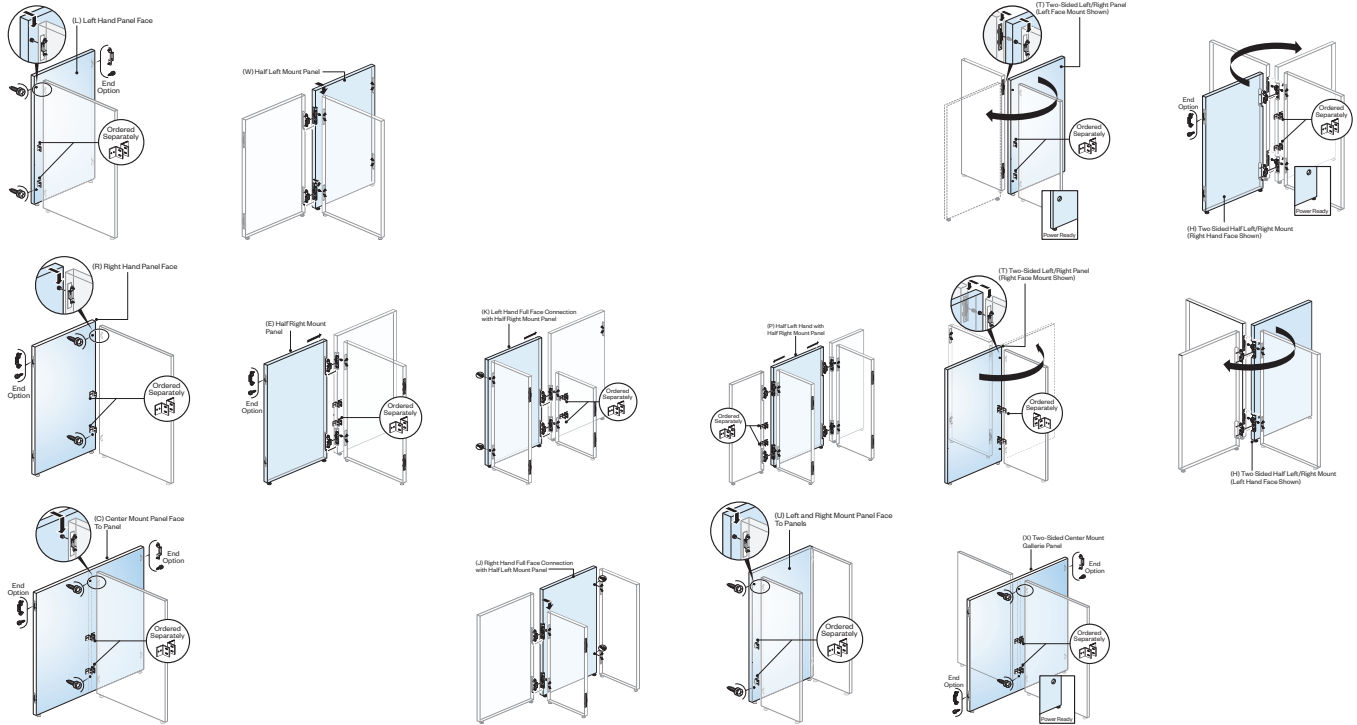

Panels with a single Face Connection - (one face only):
L - Left Mount
R - Right Mount
E - Half Right Mount
W - Half Left Mount
C - Center Mount

Panels with two Face Connections - (one face only):
K - Left with Half Right Mounts
J - Right with Half Left Mounts
P - Half Left and Half Right Mounts
U - Left and Right Mounts

Panels with a single Face Connection - (both faces):
T - Two-Sided Left/Right Mount
H - Two-Sided Half Left/Right Mount
X - Two-Sided Center Mount

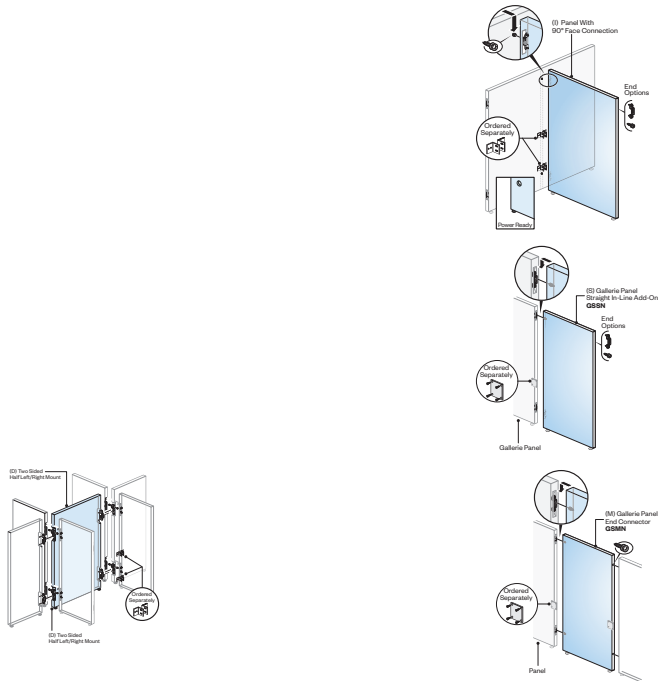

Panels with two Face Connections - (both faces):
D - Two-Sided Half Left and Half Right Mounts

Panels with no Face Connection:
I - None (finished end)/No connection (finished end)
- Female (connection end)/Female (connection end)
- Female (connection end)/No connection (finished end)
S - Male (connection end)/Female (connection end)
- Male (connection end)/No connection (finished end)
M - Male (connection end)/Male (connection end)

Haworth Gallerie

At-a-Glance

Common Features

- Includes one pre-drilled, finished panel and attachment hardware.
- Panel is 1.18"(30mm) thick.
- High-pressure laminate (HPL) panel has 1mm edgeband.
- Glides provide 1.5"(38mm) level adjustment.
- Panel and hardware are field installed.
- Rail for glass ready option standard in black.
- Spine adjacent pass through at power console height. See product details for exact locations and dimensions for each Panel configuration.

Common Specification Tips

- **Not for use with Compose or Compose Gallery Panels.**
- Connecting panels may be shorter, the same height or taller than each other based on the panel type:
 - If panels are different heights, select the connection height of the shortest panel.
 - If panels are the same height, select this connection height.
 - Half connection ends:
 - Require a half connection to complete the configuration.
 - Match panel heights; widths may be different.
 - Match one sided to one sided; two sided to two sided
 - Do not mix one sided and two sided panels
 - Panel End attachment is not specified on the same hand as the face attachment. Refer to the Specification Guide for face and end mounting application guidelines.
- All face connections on a single panel will always be the same height. The exception is J and K panels which allow for different face connection heights.
- For attachment to other panels:
 - Separately specify one Tie Plate (ZBBP-0000-PN) to secure end-to-end panels in 180° conditions. Required at each end-to-end connection.
 - Separately specify Panel Attachment Brackets (ZUBW-0000-PN or ZUBW-0000-CN) for each 90° panel to panel condition. Each inside corner requires two Panel Attachment Brackets.
- Specify No Glass option when using Glass Topper Holder Kit.
- No Glass option panels cannot be retrofit to Glass Ready option.
- Separately specify:
 - Insert Glass for Glass-Ready panels
 - Glass Topper Holder Kit
- To route power through panels use:
 - Factory drill power cutout.
 - Field cut.
- Separately specified grommet to finished any visible cutout.

Panel to Panel Face Attachment

L/R (Left or Right Mount)

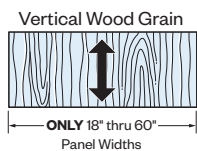
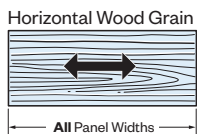
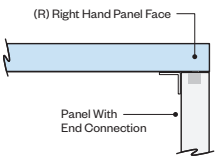
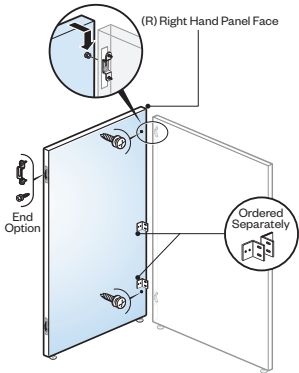
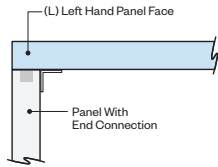
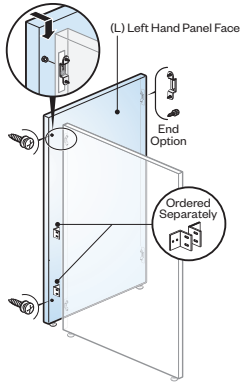

GSLB (Left Face)
GSRB (Right Face)
Class BC

Features

- Face connection adds 1.18"(30mm) to width.
- Handedness is determined by face connection.

Specification Tips

- Designed to connect to other panels on the face and/or end.
- Panel has one face (male) and one optional end connection (female); select right hand or left hand.
- **Not for use with Compose or Compose Gallery panels.**
- For attachment to other panels:
 - Separately specify one Tie Plate (ZBBP-0000-PN) to secure end-to-end panels in 180° conditions. Required at each end-to-end connection.
 - Separately specify Panel Attachment Brackets (ZUBW-0000-PN or ZUBW-0000-CN) for each 90° panel to panel condition. Each inside corner requires two Panel Attachment Brackets.
- Wood grain laminate can be vertical or horizontal. See illustrations below for limitations. Specify appropriate laminate surface code.

To Order, Specify:

1) Product number, including:

1 Face Handed Connection

- L** Left Face
- R** Right Face

2 Face Connection Height (Male)

- B** 34"(864mm)H Connection
- C** 42"(1067mm)H Connection
- D** 50"(1270mm)H Connection

3 Left End (Finished End or Connection End) (Female)

- N** No Connection (Finished End)
- B** 34"(864mm)H Connection (only on R panels)
- C** 42"(1067mm)H Connection (Only on R panels)
- D** 50"(1270mm)H Connection (only on R panels)

4 Right End (Finished End or Connection End) (Female)

- N** No Connection (Finished End)
- B** 34"(864mm)H Connection (Only on L panels)
- C** 42"(1067mm)H Connection (Only on L panels)
- D** 50"(1270mm)H Connection (Only on L panels)

5 Glass Options

- N** No Glass (Finished Top)
- G** Glass Ready

2) HPL surface color.
3) Edgeband color.

Panel to Panel Face Attachment

L/R (Left or Right Mount)

Nominal Height	Actual Width	Nominal Width	Number		No Glass HPL		Glass Ready HPL			
			①②	③④⑤	A	B	A	B		
34"(864mm)	19.8"(503mm)	18"(457mm)	GS	B-3418-L	■ ■ ■ ■ ■	N	\$610.08	\$642.46	\$838.67	\$871.05
	25.8"(655mm)	24"(610mm)	GS	B-3424-L	■ ■ ■ ■ ■	N	647.31	690.49	930.40	973.58
	31.8"(808mm)	30"(762mm)	GS	B-3430-L	■ ■ ■ ■ ■	N	684.54	738.52	1022.13	1076.11
	37.8"(960mm)	36"(914mm)	GS	B-3436-L	■ ■ ■ ■ ■	N	877.21	941.98	1269.30	1334.07
	43.8"(1113mm)	42"(1067mm)	GS	B-3442-L	■ ■ ■ ■ ■	N	1011.59	1087.15	1458.18	1533.74
	49.8"(1265mm)	48"(1219mm)	GS	B-3448-L	■ ■ ■ ■ ■	N	1048.82	1135.18	1549.91	1636.27
	45.8"(1163mm)	54"(1372mm)	GS	B-3454-L	■ ■ ■ ■ ■	N	1086.05	1183.20	1641.64	1738.79
	61.8"(1570mm)	60"(1524mm)	GS	B-3460-L	■ ■ ■ ■ ■	N	1123.28	1231.23	1733.37	1841.32
	67.8"(1722mm)	66"(1676mm)	GS	B-3466-L	■ ■ ■ ■ ■	N	1160.51	1279.26	1825.10	1943.85
	73.8"(1875mm)	72"(1829mm)	GS	B-3472-L	■ ■ ■ ■ ■	N	1197.74	1327.28	1916.83	2046.37
	79.8"(2027mm)	78"(1981mm)	GS	B-3478-L	■ ■ ■ ■ ■	N	1234.97	1375.30	2008.56	2148.89
	85.8"(2179mm)	84"(2134mm)	GS	B-3484-L	■ ■ ■ ■ ■	N	1272.20	1423.33	2100.29	2251.42
	91.8"(2332mm)	90"(2286mm)	GS	B-3490-L	■ ■ ■ ■ ■	N	1309.43	1471.35	2192.02	2353.94
	97.8"(2484mm)	96"(2438mm)	GS	B-3496-L	■ ■ ■ ■ ■	N	1346.66	1519.38	2283.75	2456.47
42"(1067mm)	103.8"(2637mm)	102"(2591mm)	GS	B-34A2-L	■ ■ ■ ■ ■	N	1383.89	1567.41	2375.48	2559.00
	109.8"(2789mm)	108"(2743mm)	GS	B-34A8-L	■ ■ ■ ■ ■	N	1421.12	1615.43	2467.21	2661.52
	115.8"(2941mm)	114"(2896mm)	GS	B-34B4-L	■ ■ ■ ■ ■	N	1458.35	1663.45	2558.94	2764.04
	19.8"(503mm)	18"(457mm)	GS	-4218-L	■ ■ ■ ■ ■	N	\$ 636.36	\$ 676.36	\$ 864.95	\$ 904.95
	25.8"(655mm)	24"(610mm)	GS	-4224-L	■ ■ ■ ■ ■	N	682.35	735.69	965.44	1018.78
	31.8"(808mm)	30"(762mm)	GS	-4230-L	■ ■ ■ ■ ■	N	728.34	795.01	1065.93	1132.60
	37.8"(960mm)	36"(914mm)	GS	-4236-L	■ ■ ■ ■ ■	N	929.77	1009.78	1321.86	1401.87
	43.8"(1113mm)	42"(1067mm)	GS	-4242-L	■ ■ ■ ■ ■	N	1072.91	1166.25	1519.50	1612.84
	49.8"(1265mm)	48"(1219mm)	GS	-4248-L	■ ■ ■ ■ ■	N	1118.90	1225.58	1619.99	1726.67
	45.8"(1163mm)	54"(1372mm)	GS	-4254-L	■ ■ ■ ■ ■	N	1164.89	1284.90	1720.48	1840.49
	61.8"(1570mm)	60"(1524mm)	GS	-4260-L	■ ■ ■ ■ ■	N	1210.88	1344.23	1820.97	1954.32
	67.8"(1722mm)	66"(1676mm)	GS	-4266-L	■ ■ ■ ■ ■	N	1256.87	1403.55	1921.46	2068.14
	73.8"(1875mm)	72"(1829mm)	GS	-4272-L	■ ■ ■ ■ ■	N	1302.86	1462.88	2021.95	2181.97
	79.8"(2027mm)	78"(1981mm)	GS	-4278-L	■ ■ ■ ■ ■	N	1348.85	1522.20	2122.44	2295.79
85.8"(2179mm)	84"(2134mm)	GS	-4284-L	■ ■ ■ ■ ■	N	1394.84	1581.53	2222.93	2409.62	
91.8"(2332mm)	90"(2286mm)	GS	-4290-L	■ ■ ■ ■ ■	N	1440.83	1640.85	2323.42	2523.44	
97.8"(2484mm)	96"(2438mm)	GS	-4296-L	■ ■ ■ ■ ■	N	1486.82	1700.18	2423.91	2637.27	
50"(1270mm)	103.8"(2637mm)	102"(2591mm)	GS	-42A2-L	■ ■ ■ ■ ■	N	1532.81	1759.50	2524.40	2751.09
	109.8"(2789mm)	108"(2743mm)	GS	-42A8-L	■ ■ ■ ■ ■	N	1578.80	1818.83	2624.89	2864.92
	115.8"(2941mm)	114"(2896mm)	GS	-42B4-L	■ ■ ■ ■ ■	N	1624.79	1878.15	2725.38	2978.74
	19.8"(503mm)	18"(457mm)	GS	-5018-L	■ ■ ■ ■ ■	N	\$ 662.64	\$ 710.26	\$ 891.23	\$ 938.85
	25.8"(655mm)	24"(610mm)	GS	-5024-L	■ ■ ■ ■ ■	N	717.39	780.89	1000.48	1063.98
	31.8"(808mm)	30"(762mm)	GS	-5030-L	■ ■ ■ ■ ■	N	772.14	851.51	1109.73	1189.10
	37.8"(960mm)	36"(914mm)	GS	-5036-L	■ ■ ■ ■ ■	N	982.33	1077.58	1374.42	1469.67
	43.8"(1113mm)	42"(1067mm)	GS	-5042-L	■ ■ ■ ■ ■	N	1134.23	1245.36	1580.82	1691.95
	49.8"(1265mm)	48"(1219mm)	GS	-5048-L	■ ■ ■ ■ ■	N	1188.98	1315.98	1690.07	1817.07
	45.8"(1163mm)	54"(1372mm)	GS	-5054-L	■ ■ ■ ■ ■	N	1243.73	1386.60	1799.32	1942.19
	61.8"(1570mm)	60"(1524mm)	GS	-5060-L	■ ■ ■ ■ ■	N	1298.48	1457.23	1908.57	2067.32
	67.8"(1722mm)	66"(1676mm)	GS	-5066-L	■ ■ ■ ■ ■	N	1353.23	1527.85	2017.82	2192.44
	73.8"(1875mm)	72"(1829mm)	GS	-5072-L	■ ■ ■ ■ ■	N	1407.98	1598.48	2127.07	2317.57
	79.8"(2027mm)	78"(1981mm)	GS	-5078-L	■ ■ ■ ■ ■	N	1462.73	1669.11	2236.32	2442.70
85.8"(2179mm)	84"(2134mm)	GS	-5084-L	■ ■ ■ ■ ■	N	1517.48	1739.73	2345.57	2567.82	
91.8"(2332mm)	90"(2286mm)	GS	-5090-L	■ ■ ■ ■ ■	N	1572.23	1810.35	2454.82	2692.94	
97.8"(2484mm)	96"(2438mm)	GS	-5096-L	■ ■ ■ ■ ■	N	1626.98	1880.98	2564.07	2818.07	
103.8"(2637mm)	102"(2591mm)	GS	-50A2-L	■ ■ ■ ■ ■	N	1681.73	1951.60	2673.32	2943.19	
109.8"(2789mm)	108"(2743mm)	GS	-50A8-L	■ ■ ■ ■ ■	N	1736.48	2022.23	2782.57	3068.32	
115.8"(2941mm)	114"(2896mm)	GS	-50B4-L	■ ■ ■ ■ ■	N	1791.23	2092.86	2891.82	3193.45	

Panel to Panel Face Attachment

W/E (Half Left or Half Right Mount)

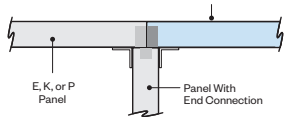
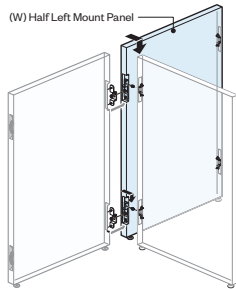
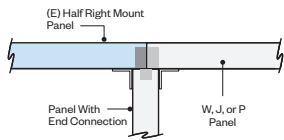
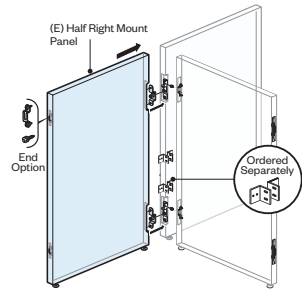

Horizontal Wood Grain

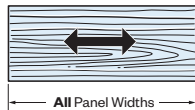

Vertical Wood Grain

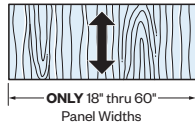

GSEB (Right Face)
GSWB (Left Face)
Class BC

Features

- Half face connection adds 0.59"(15mm) to width.
- Handedness is determined by face connection.

Specification Tips

- Designed to connect to other panels on the face and/or end.
- A half-left and a half-right panel (E, W, K, J, or P) are required for this application. Panel heights and face connection must match, widths may be different.
- Panel has one handed half face (male) and one optional end (female) connection; select right handed or left handed.
- **Not for use with Composite or Composite Gallery panels.**
- For attachment to other panels:
 - Separately specify one Tie Plate (ZBBP-0000-PN) to secure end-to-end panels in 180° conditions. Required at each end-to-end connection.
 - Separately specify Panel Attachment Brackets (ZUBW-0000-PN or ZUBW-0000-CN) for each 90° panel to panel condition. Each inside corner requires two Panel Attachment Brackets.
- Wood grain laminate can be vertical or horizontal. See illustrations below for limitations. Specify appropriate laminate surface code.

To Order, Specify:

1) Product number, including:

1 Face Connection Height (Male)

- B** 34"(864mm)H Connection
- C** 42"(1067mm)H Connection
- D** 50"(1270mm)H Connection

2 Left End (Finished End or Connection End) (Female)

- N** No Connection (Finished End)
- B** 34"(864mm)H Connection (only for E panels)
- C** 42"(1067mm)H Connection (only for E panels)
- D** 50"(1270mm)H Connection (only for E panels)

3 Right End (Finished End or Connection End) (Female)

- N** No Connection (Finished End)
- B** 34"(864mm)H Connection (only for W panels)
- C** 42"(1067mm)H Connection (only for W panels)
- D** 50"(1270mm)H Connection (only for W panels)

4 Glass Options

- N** No Glass (Finished Top)
- G** Glass Ready

2) HPL surface color.

3) Edgeband color.

Panel to Panel Face Attachment

W/E (Half Left or Half Right Mount)

Nominal Height	Actual Width	Nominal Width	Number			No Glass HPL		Glass Ready HPL	
			①	②	③	A	B	A	B
East / Right Face Connection									
34"(864mm)	19.59"(498mm)	18"(457mm)	GSEB-3418-L	N	N	\$ 757.95	\$ 790.33	\$ 986.54	\$ 1018.92
	25.59"(650mm)	24"(610mm)	GSEB-3424-L	N	N	795.18	838.36	1078.27	1121.45
	31.59"(802mm)	30"(762mm)	GSEB-3430-L	N	N	832.41	886.39	1170.00	1223.98
	37.59"(955mm)	36"(914mm)	GSEB-3436-L	N	N	1025.08	1089.85	1417.17	1481.94
	43.59"(1107mm)	42"(1067mm)	GSEB-3442-L	N	N	1159.46	1235.02	1606.05	1681.61
	49.59"(1260mm)	48"(1219mm)	GSEB-3448-L	N	N	1196.69	1283.05	1697.78	1784.14
	55.59"(1412mm)	54"(1372mm)	GSEB-3454-L	N	N	1233.92	1331.07	1789.51	1886.66
	61.59"(1564mm)	60"(1524mm)	GSEB-3460-L	N	N	1271.15	1379.10	1881.24	1989.19
	67.59"(1717mm)	66"(1676mm)	GSEB-3466-L	N	N	1308.38	1427.13	1972.97	2091.72
	73.59"(1869mm)	72"(1829mm)	GSEB-3472-L	N	N	1345.61	1475.15	2064.70	2194.24
	79.59"(2022mm)	78"(1981mm)	GSEB-3478-L	N	N	1382.84	1523.17	2156.43	2296.76
	85.59"(2174mm)	84"(2134mm)	GSEB-3484-L	N	N	1420.07	1571.20	2248.16	2399.29
	91.59"(2326mm)	90"(2286mm)	GSEB-3490-L	N	N	1457.30	1619.22	2339.89	2501.81
	97.59"(2479mm)	96"(2438mm)	GSEB-3496-L	N	N	1494.53	1667.25	2431.62	2604.34
103.59"(2631mm)	102"(2591mm)	GSEB-34A2-L	N	N	1531.76	1715.28	2523.35	2706.87	
109.59"(2784mm)	108"(2743mm)	GSEB-34A8-L	N	N	1568.99	1763.30	2615.08	2809.39	
115.59"(2936mm)	114"(2896mm)	GSEB-34B4-L	N	N	1606.22	1811.32	2706.81	2911.91	
42"(1067mm)	19.59"(498mm)	18"(457mm)	GSE -4218-L	N	N	\$ 784.23	\$ 824.23	\$ 1012.82	\$ 1052.82
	25.59"(650mm)	24"(610mm)	GSE -4224-L	N	N	830.22	883.56	1113.31	1166.65
	31.59"(802mm)	30"(762mm)	GSE -4230-L	N	N	876.21	942.88	1213.80	1280.47
	37.59"(955mm)	36"(914mm)	GSE -4236-L	N	N	1077.64	1157.65	1469.73	1549.74
	43.59"(1107mm)	42"(1067mm)	GSE -4242-L	N	N	1220.78	1314.12	1667.37	1760.71
	49.59"(1260mm)	48"(1219mm)	GSE -4248-L	N	N	1266.77	1373.45	1767.86	1874.54
	55.59"(1412mm)	54"(1372mm)	GSE -4254-L	N	N	1312.76	1432.77	1868.35	1988.36
	61.59"(1564mm)	60"(1524mm)	GSE -4260-L	N	N	1358.75	1492.10	1968.84	2102.19
	67.59"(1717mm)	66"(1676mm)	GSE -4266-L	N	N	1404.74	1551.42	2069.33	2216.01
	73.59"(1869mm)	72"(1829mm)	GSE -4272-L	N	N	1450.73	1610.75	2169.82	2329.84
	79.59"(2022mm)	78"(1981mm)	GSE -4278-L	N	N	1496.72	1670.07	2270.31	2443.66
	85.59"(2174mm)	84"(2134mm)	GSE -4284-L	N	N	1542.71	1729.40	2370.80	2557.49
	91.59"(2326mm)	90"(2286mm)	GSE -4290-L	N	N	1588.70	1788.72	2471.29	2671.31
	97.59"(2479mm)	96"(2438mm)	GSE -4296-L	N	N	1634.69	1848.05	2571.78	2785.14
103.59"(2631mm)	102"(2591mm)	GSE -42A2-L	N	N	1680.68	1907.37	2672.27	2898.96	
109.59"(2784mm)	108"(2743mm)	GSE -42A8-L	N	N	1726.67	1966.70	2772.76	3012.79	
115.59"(2936mm)	114"(2896mm)	GSE -42B4-L	N	N	1772.66	2026.02	2873.25	3126.61	
50"(1270mm)	19.59"(498mm)	18"(457mm)	GSE -5018-L	N	N	\$ 810.51	\$ 858.13	\$ 1039.10	\$ 1086.72
	25.59"(650mm)	24"(610mm)	GSE -5024-L	N	N	865.26	928.76	1148.35	1211.85
	31.59"(802mm)	30"(762mm)	GSE -5030-L	N	N	920.01	999.38	1257.60	1336.97
	37.59"(955mm)	36"(914mm)	GSE -5036-L	N	N	1130.20	1225.45	1522.29	1617.54
	43.59"(1107mm)	42"(1067mm)	GSE -5042-L	N	N	1282.10	1393.23	1728.69	1839.82
	49.59"(1260mm)	48"(1219mm)	GSE -5048-L	N	N	1336.85	1463.85	1837.94	1964.94
	55.59"(1412mm)	54"(1372mm)	GSE -5054-L	N	N	1391.60	1534.47	1947.19	2090.06
	61.59"(1564mm)	60"(1524mm)	GSE -5060-L	N	N	1446.35	1605.10	2056.44	2215.19
	67.59"(1717mm)	66"(1676mm)	GSE -5066-L	N	N	1501.10	1675.72	2165.69	2340.31
	73.59"(1869mm)	72"(1829mm)	GSE -5072-L	N	N	1555.85	1746.35	2274.94	2465.44
	79.59"(2022mm)	78"(1981mm)	GSE -5078-L	N	N	1610.60	1816.98	2384.19	2590.57
	85.59"(2174mm)	84"(2134mm)	GSE -5084-L	N	N	1665.35	1887.60	2493.44	2715.69
	91.59"(2326mm)	90"(2286mm)	GSE -5090-L	N	N	1720.10	1958.22	2602.69	2840.81
	97.59"(2479mm)	96"(2438mm)	GSE -5096-L	N	N	1774.85	2028.85	2711.94	2965.94
103.59"(2631mm)	102"(2591mm)	GSE -50A2-L	N	N	1829.60	2099.47	2821.19	3091.06	
109.59"(2784mm)	108"(2743mm)	GSE -50A8-L	N	N	1884.35	2170.10	2930.44	3216.19	
115.59"(2936mm)	114"(2896mm)	GSE -50B4-L	N	N	1939.10	2240.73	3039.69	3341.32	

Panel to Panel Face Attachment

W/E (Half Left or Half Right Mount)

Nominal Height	Actual Width	Nominal Width	Number		No Glass HPL		Glass Ready HPL	
			①	②③	A	B	A	B
West / Left Face Connection								
34"(864mm)	19.59"(498mm)	18"(457mm)	GSWB-3418-LN	■ ■ N	\$ 757.95	\$ 790.33	\$ 986.54	\$ 1018.92
	25.59"(650mm)	24"(610mm)	GSWB-3424-LN	■ ■ N	795.18	838.36	1078.27	1121.45
	31.59"(802mm)	30"(762mm)	GSWB-3430-LN	■ ■ N	832.41	886.39	1170.00	1223.98
	37.59"(955mm)	36"(914mm)	GSWB-3436-LN	■ ■ N	1025.08	1089.85	1417.17	1481.94
	43.59"(1107mm)	42"(1067mm)	GSWB-3442-LN	■ ■ N	1159.46	1235.02	1606.05	1681.61
	49.59"(1260mm)	48"(1219mm)	GSWB-3448-LN	■ ■ N	1196.69	1283.05	1697.78	1784.14
	55.59"(1412mm)	54"(1372mm)	GSWB-3454-LN	■ ■ N	1233.92	1331.07	1789.51	1886.66
	61.59"(1564mm)	60"(1524mm)	GSWB-3460-LN	■ ■ N	1271.15	1379.10	1881.24	1989.19
	67.59"(1717mm)	66"(1676mm)	GSWB-3466-LN	■ ■ N	1308.38	1427.13	1972.97	2091.72
	73.59"(1869mm)	72"(1829mm)	GSWB-3472-LN	■ ■ N	1345.61	1475.15	2064.70	2194.24
	79.59"(2022mm)	78"(1981mm)	GSWB-3478-LN	■ ■ N	1382.84	1523.17	2156.43	2296.76
	85.59"(2174mm)	84"(2134mm)	GSWB-3484-LN	■ ■ N	1420.07	1571.20	2248.16	2399.29
	91.59"(2326mm)	90"(2286mm)	GSWB-3490-LN	■ ■ N	1457.30	1619.22	2339.89	2501.81
	97.59"(2479mm)	96"(2438mm)	GSWB-3496-LN	■ ■ N	1494.53	1667.25	2431.62	2604.34
103.59"(2631mm)	102"(2591mm)	GSWB-34A2-LN	■ ■ N	1531.76	1715.28	2523.35	2706.87	
109.59"(2784mm)	108"(2743mm)	GSWB-34A8-LN	■ ■ N	1568.99	1763.30	2615.08	2809.39	
115.59"(2936mm)	114"(2896mm)	GSWB-34B4-LN	■ ■ N	1606.22	1811.32	2706.81	2911.91	
42"(1067mm)	19.59"(498mm)	18"(457mm)	GSW -4218-LN	■ ■ N	\$ 784.23	\$ 824.23	\$ 1012.82	\$ 1052.82
	25.59"(650mm)	24"(610mm)	GSW -4224-LN	■ ■ N	830.22	883.56	1113.31	1166.65
	31.59"(802mm)	30"(762mm)	GSW -4230-LN	■ ■ N	876.21	942.88	1213.80	1280.47
	37.59"(955mm)	36"(914mm)	GSW -4236-LN	■ ■ N	1077.64	1157.65	1469.73	1549.74
	43.59"(1107mm)	42"(1067mm)	GSW -4242-LN	■ ■ N	1220.78	1314.12	1667.37	1760.71
	49.59"(1260mm)	48"(1219mm)	GSW -4248-LN	■ ■ N	1266.77	1373.45	1767.86	1874.54
	55.59"(1412mm)	54"(1372mm)	GSW -4254-LN	■ ■ N	1312.76	1432.77	1868.35	1988.36
	61.59"(1564mm)	60"(1524mm)	GSW -4260-LN	■ ■ N	1358.75	1492.10	1968.84	2102.19
	67.59"(1717mm)	66"(1676mm)	GSW -4266-LN	■ ■ N	1404.74	1551.42	2069.33	2216.01
	73.59"(1869mm)	72"(1829mm)	GSW -4272-LN	■ ■ N	1450.73	1610.75	2169.82	2329.84
	79.59"(2022mm)	78"(1981mm)	GSW -4278-LN	■ ■ N	1496.72	1670.07	2270.31	2443.66
	85.59"(2174mm)	84"(2134mm)	GSW -4284-LN	■ ■ N	1542.71	1729.40	2370.80	2557.49
	91.59"(2326mm)	90"(2286mm)	GSW -4290-LN	■ ■ N	1588.70	1788.72	2471.29	2671.31
	97.59"(2479mm)	96"(2438mm)	GSW -4296-LN	■ ■ N	1634.69	1848.05	2571.78	2785.14
103.59"(2631mm)	102"(2591mm)	GSW -42A2-LN	■ ■ N	1680.68	1907.37	2672.27	2898.96	
109.59"(2784mm)	108"(2743mm)	GSW -42A8-LN	■ ■ N	1726.67	1966.70	2772.76	3012.79	
115.59"(2936mm)	114"(2896mm)	GSW -42B4-LN	■ ■ N	1772.66	2026.02	2873.25	3126.61	
50"(1270mm)	19.59"(498mm)	18"(457mm)	GSW -5018-LN	■ ■ N	\$ 810.51	\$ 858.13	\$ 1039.10	\$ 1086.72
	25.59"(650mm)	24"(610mm)	GSW -5024-LN	■ ■ N	865.26	928.76	1148.35	1211.85
	31.59"(802mm)	30"(762mm)	GSW -5030-LN	■ ■ N	920.01	999.38	1257.60	1336.97
	37.59"(955mm)	36"(914mm)	GSW -5036-LN	■ ■ N	1130.20	1225.45	1522.29	1617.54
	43.59"(1107mm)	42"(1067mm)	GSW -5042-LN	■ ■ N	1282.10	1393.23	1728.69	1839.82
	49.59"(1260mm)	48"(1219mm)	GSW -5048-LN	■ ■ N	1336.85	1463.85	1837.94	1964.94
	55.59"(1412mm)	54"(1372mm)	GSW -5054-LN	■ ■ N	1391.60	1534.47	1947.19	2090.06
	61.59"(1564mm)	60"(1524mm)	GSW -5060-LN	■ ■ N	1446.35	1605.10	2056.44	2215.19
	67.59"(1717mm)	66"(1676mm)	GSW -5066-LN	■ ■ N	1501.10	1675.72	2165.69	2340.31
	73.59"(1869mm)	72"(1829mm)	GSW -5072-LN	■ ■ N	1555.85	1746.35	2274.94	2465.44
	79.59"(2022mm)	78"(1981mm)	GSW -5078-LN	■ ■ N	1610.60	1816.98	2384.19	2590.57
	85.59"(2174mm)	84"(2134mm)	GSW -5084-LN	■ ■ N	1665.35	1887.60	2493.44	2715.69
	91.59"(2326mm)	90"(2286mm)	GSW -5090-LN	■ ■ N	1720.10	1958.22	2602.69	2840.81
	97.59"(2479mm)	96"(2438mm)	GSW -5096-LN	■ ■ N	1774.85	2028.85	2711.94	2965.94
103.59"(2631mm)	102"(2591mm)	GSW -50A2-LN	■ ■ N	1829.60	2099.47	2821.19	3091.06	
109.59"(2784mm)	108"(2743mm)	GSW -50A8-LN	■ ■ N	1884.35	2170.10	2930.44	3216.19	
115.59"(2936mm)	114"(2896mm)	GSW -50B4-LN	■ ■ N	1939.10	2240.73	3039.69	3341.32	

Panel to Panel Face Attachment C (Center Mount)

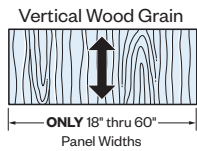
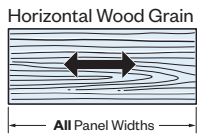
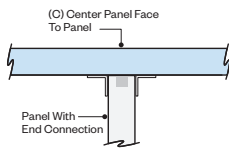
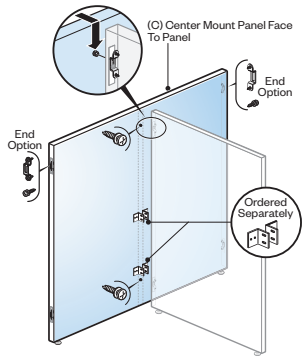

GSC Center Mount
Class BC

Feature

- Face connection adds 1.18"(30mm) to width.

Specification Tips

- Designed to connect to other panels on the face and/or ends.
- Panel has one face (male) and two optional end (female) connections.
- **Not for use with Compose or Compose Gallery panels.**
- For attachment to other panels:
 - Separately specify one Tie Plate (ZBBP-0000-PN) to secure end-to-end panels in 180° conditions. Required at each end-to-end connection.
 - Separately specify Panel Attachment Brackets (ZUBW-0000-PN or ZUBW-0000-CN) for each 90° panel to panel condition. Each inside corner requires two Panel Attachment Brackets.
- Wood grain laminate can be vertical or horizontal. See illustrations below for limitations. Specify appropriate laminate surface code.

To Order, Specify:

1) Product number, including:

1 Face Connection Height (Male)

- B** 34"(864mm)H Connection
- C** 42"(1067mm)H Connection
- D** 50"(1270mm)H Connection

2 Left End (Finished End or Connection End) (Female)

- N** No Connection (Finished End)
- B** 34"(864mm)H Connection
- C** 42"(1067mm)H Connection
- D** 50"(1270mm)H Connection

3 Right End (Finished End or Connection End) (Female)

- N** No Connection (Finished End)
- B** 34"(864mm)H Connection
- C** 42"(1067mm)H Connection
- D** 50"(1270mm)H Connection

4 Glass Options

- N** No Glass (Finished Top)
- G** Glass Ready

2) HPL surface color.

3) Edgeband color.

Panel to Panel Face Attachment C (Center Mount)

Nominal Height	Actual Width	Nominal Width	Number		No Glass HPL		Glass Ready HPL	
			①	②③④	A	B	A	B
34"(864mm)	19.18"(487mm)	18"(457mm)	GSCB-3418-L	■ ■ ■ ■ N	\$610.08	\$642.46	\$838.67	\$871.05
	25.18"(640mm)	24"(610mm)	GSCB-3424-L	■ ■ ■ ■ N	647.31	690.49	930.40	973.58
	31.18"(792mm)	30"(762mm)	GSCB-3430-L	■ ■ ■ ■ N	684.54	738.52	1022.13	1076.11
	37.18"(944mm)	36"(914mm)	GSCB-3436-L	■ ■ ■ ■ N	877.21	941.98	1269.30	1334.07
	43.18"(1097mm)	42"(1067mm)	GSCB-3442-L	■ ■ ■ ■ N	1011.59	1087.15	1458.18	1533.74
	49.18"(1249mm)	48"(1219mm)	GSCB-3448-L	■ ■ ■ ■ N	1048.82	1135.18	1549.91	1636.27
	55.18"(1402mm)	54"(1372mm)	GSCB-3454-L	■ ■ ■ ■ N	1086.05	1183.20	1641.64	1738.79
	61.18"(1554mm)	60"(1524mm)	GSCB-3460-L	■ ■ ■ ■ N	1123.28	1231.23	1733.37	1841.32
	67.18"(1706mm)	66"(1676mm)	GSCB-3466-L	■ ■ ■ ■ N	1160.51	1279.26	1825.10	1943.85
	73.18"(1859mm)	72"(1829mm)	GSCB-3472-L	■ ■ ■ ■ N	1197.74	1327.28	1916.83	2046.37
	79.18"(2011mm)	78"(1981mm)	GSCB-3478-L	■ ■ ■ ■ N	1234.97	1375.30	2008.56	2148.89
	85.18"(2164mm)	84"(2134mm)	GSCB-3484-L	■ ■ ■ ■ N	1272.20	1423.33	2100.29	2251.42
	91.18"(2316mm)	90"(2286mm)	GSCB-3490-L	■ ■ ■ ■ N	1309.43	1471.35	2192.02	2353.94
	97.18"(2468mm)	96"(2438mm)	GSCB-3496-L	■ ■ ■ ■ N	1346.66	1519.38	2283.75	2456.47
42"(1067mm)	103.18"(2621mm)	102"(2591mm)	GSCB-34A2-L	■ ■ ■ ■ N	1383.89	1567.41	2375.48	2559.00
	109.18"(2773mm)	108"(2743mm)	GSCB-34A8-L	■ ■ ■ ■ N	1421.12	1615.43	2467.21	2661.52
	115.18"(2926mm)	114"(2896mm)	GSCB-34B4-L	■ ■ ■ ■ N	1458.35	1663.45	2558.94	2764.04
	19.18"(487mm)	18"(457mm)	GSC -4218-L	■ ■ ■ ■ N	\$ 636.36	\$ 676.36	\$ 864.95	\$ 904.95
	25.18"(640mm)	24"(610mm)	GSC -4224-L	■ ■ ■ ■ N	682.35	735.69	965.44	1018.78
	31.18"(792mm)	30"(762mm)	GSC -4230-L	■ ■ ■ ■ N	728.34	795.01	1065.93	1132.60
	37.18"(944mm)	36"(914mm)	GSC -4236-L	■ ■ ■ ■ N	929.77	1009.78	1321.86	1401.87
	43.18"(1097mm)	42"(1067mm)	GSC -4242-L	■ ■ ■ ■ N	1072.91	1166.25	1519.50	1612.84
	49.18"(1249mm)	48"(1219mm)	GSC -4248-L	■ ■ ■ ■ N	1118.90	1225.58	1619.99	1726.67
	55.18"(1402mm)	54"(1372mm)	GSC -4254-L	■ ■ ■ ■ N	1164.89	1284.90	1720.48	1840.49
	61.18"(1554mm)	60"(1524mm)	GSC -4260-L	■ ■ ■ ■ N	1210.88	1344.23	1820.97	1954.32
	67.18"(1706mm)	66"(1676mm)	GSC -4266-L	■ ■ ■ ■ N	1256.87	1403.55	1921.46	2068.14
	73.18"(1859mm)	72"(1829mm)	GSC -4272-L	■ ■ ■ ■ N	1302.86	1462.88	2021.95	2181.97
	79.18"(2011mm)	78"(1981mm)	GSC -4278-L	■ ■ ■ ■ N	1348.85	1522.20	2122.44	2295.79
85.18"(2164mm)	84"(2134mm)	GSC -4284-L	■ ■ ■ ■ N	1394.84	1581.53	2222.93	2409.62	
91.18"(2316mm)	90"(2286mm)	GSC -4290-L	■ ■ ■ ■ N	1440.83	1640.85	2323.42	2523.44	
97.18"(2468mm)	96"(2438mm)	GSC -4296-L	■ ■ ■ ■ N	1486.82	1700.18	2423.91	2637.27	
103.18"(2621mm)	102"(2591mm)	GSC -42A2-L	■ ■ ■ ■ N	1532.81	1759.50	2524.40	2751.09	
109.18"(2773mm)	108"(2743mm)	GSC -42A8-L	■ ■ ■ ■ N	1578.80	1818.83	2624.89	2864.92	
115.18"(2926mm)	114"(2896mm)	GSC -42B4-L	■ ■ ■ ■ N	1624.79	1878.15	2725.38	2978.74	
50"(1270mm)	19.18"(487mm)	18"(457mm)	GSC -5018-L	■ ■ ■ ■ N	\$ 662.64	\$ 710.26	\$ 891.23	\$ 938.85
	25.18"(640mm)	24"(610mm)	GSC -5024-L	■ ■ ■ ■ N	717.39	780.89	1000.48	1063.98
	31.18"(792mm)	30"(762mm)	GSC -5030-L	■ ■ ■ ■ N	772.14	851.51	1109.73	1189.10
	37.18"(944mm)	36"(914mm)	GSC -5036-L	■ ■ ■ ■ N	982.33	1077.58	1374.42	1469.67
	43.18"(1097mm)	42"(1067mm)	GSC -5042-L	■ ■ ■ ■ N	1134.23	1245.36	1580.82	1691.95
	49.18"(1249mm)	48"(1219mm)	GSC -5048-L	■ ■ ■ ■ N	1188.98	1315.98	1690.07	1817.07
	55.18"(1402mm)	54"(1372mm)	GSC -5054-L	■ ■ ■ ■ N	1243.73	1386.60	1799.32	1942.19
	61.18"(1554mm)	60"(1524mm)	GSC -5060-L	■ ■ ■ ■ N	1298.48	1457.23	1908.57	2067.32
	67.18"(1706mm)	66"(1676mm)	GSC -5066-L	■ ■ ■ ■ N	1353.23	1527.85	2017.82	2192.44
	73.18"(1859mm)	72"(1829mm)	GSC -5072-L	■ ■ ■ ■ N	1407.98	1598.48	2127.07	2317.57
	79.18"(2011mm)	78"(1981mm)	GSC -5078-L	■ ■ ■ ■ N	1462.73	1669.11	2236.32	2442.70
	85.18"(2164mm)	84"(2134mm)	GSC -5084-L	■ ■ ■ ■ N	1517.48	1739.73	2345.57	2567.82
	91.18"(2316mm)	90"(2286mm)	GSC -5090-L	■ ■ ■ ■ N	1572.23	1810.35	2454.82	2692.94
	97.18"(2468mm)	96"(2438mm)	GSC -5096-L	■ ■ ■ ■ N	1626.98	1880.98	2564.07	2818.07
103.18"(2621mm)	102"(2591mm)	GSC -50A2-L	■ ■ ■ ■ N	1681.73	1951.60	2673.32	2943.19	
109.18"(2773mm)	108"(2743mm)	GSC -50A8-L	■ ■ ■ ■ N	1736.48	2022.23	2782.57	3068.32	
115.18"(2926mm)	114"(2896mm)	GSC -50B4-L	■ ■ ■ ■ N	1791.23	2092.86	2891.82	3193.45	

Panel to Panel Face Attachment

K/J (Left or Right Full Face Connection Mount with Half Mount)

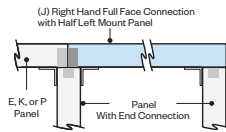
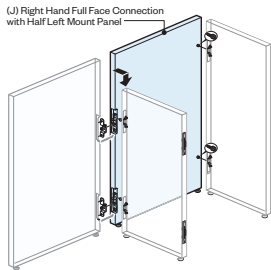
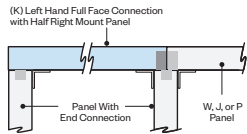
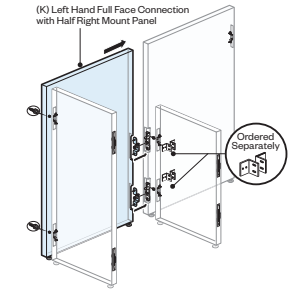

Horizontal Wood Grain

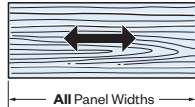

Vertical Wood Grain

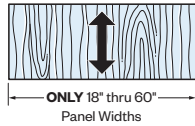

GSJBB (Right Face)
GSKBB (Left Face)
Class BC

Features

- Face connections add 1.77"(45mm) to width.
- Handedness is determined by full face connection.

Specification Tips

- Designed to connect to other panels on the face and/or end.
- A half connection requires another half connection of the same height to complete application. J Panel can connect to K, E or P. K Panel can connect to J, W, or P.
- Panel has one handed face (male), one half face (male).
- Face and half face connections may be different panel heights.
- **Not for use with Compose or Compose Gallery panels.**
- For attachment to other panels:
 - Separately specify one Tie Plate (ZBBP-0000-PN) to secure end-to-end panels in 180° conditions. Required at each end-to-end connection.
 - Separately specify Panel Attachment Brackets (ZUBW-0000-PN or ZUBW-0000-CN) for each 90° panel to panel condition. Each inside corner requires two Panel Attachment Brackets.
- Wood grain laminate can be vertical or horizontal. See illustrations below for limitations. Specify appropriate laminate surface code.

To Order, Specify:

- 1) Product number, including:

K Option (LH Full Face Connection/RH Half Face Connection)

1 LH Full Face Connection

- B** 34"(864mm)H Connection
- C** 42"(1067mm)H Connection
- D** 50"(1270mm)H Connection

2 RH Half Face Connection

- B** 34"(864mm)H Connection
- C** 42"(1067mm)H Connection
- D** 50"(1270mm)H Connection

3 Glass Options

- N** No Glass (Finished Top)
- G** Glass Ready

- 2) HPL surface color.

- 3) Edgeband color.

J Option (LH Half Face Connection/RH Full Face Connection)

1 LH Half Face Connection

- B** 34"(864mm)H Connection
- C** 42"(1067mm)H Connection
- D** 50"(1270mm)H Connection

2 RH Full Face Connection

- B** 34"(864mm)H Connection
- C** 42"(1067mm)H Connection
- D** 50"(1270mm)H Connection

3 Glass Options

- N** No Glass (Finished Top)
- G** Glass Ready

- 2) HPL surface color.

- 3) Edgeband color.

Panel to Panel Face Attachment

K/J (Left or Right Full Face Connection Mount with Half Mount)

Nominal Height	Actual Width	Nominal Width	Number		No Glass HPL		Glass Ready HPL		
			①②	③	A	B	A	B	
J Option (LH Half Face Connection/RH Full Face Connection)									
34"(864mm)	49.77"(1264mm)	48"(1219mm)	GSJBB-3448-LNN	N	977.15	1063.51	1478.24	1564.60	
	55.77"(1417mm)	54"(1372mm)	GSJBB-3454-LNN	N	1014.38	1111.53	1569.97	1667.12	
	61.77"(1569mm)	60"(1524mm)	GSJBB-3460-LNN	N	1051.61	1159.56	1661.70	1769.65	
	67.77"(1721mm)	66"(1676mm)	GSJBB-3466-LNN	N	1088.84	1207.59	1753.43	1872.18	
	73.77"(1874mm)	72"(1829mm)	GSJBB-3472-LNN	N	1126.07	1255.61	1845.16	1974.70	
	79.77"(2026mm)	78"(1981mm)	GSJBB-3478-LNN	N	1163.30	1303.63	1936.89	2077.22	
	85.77"(2179mm)	84"(2134mm)	GSJBB-3484-LNN	N	1200.53	1351.66	2028.62	2179.75	
	91.77"(2331mm)	90"(2286mm)	GSJBB-3490-LNN	N	1237.76	1399.68	2120.35	2282.27	
	97.77"(2483mm)	96"(2438mm)	GSJBB-3496-LNN	N	1274.99	1447.71	2212.08	2384.80	
	103.77"(2636mm)	102"(2591mm)	GSJBB-34A2-LNN	N	1312.22	1495.74	2303.81	2487.33	
	109.77"(2788mm)	108"(2743mm)	GSJBB-34A8-LNN	N	1349.45	1543.76	2395.54	2589.85	
	115.77"(2941mm)	114"(2896mm)	GSJBB-34B4-LNN	N	1386.68	1591.78	2487.27	2692.37	
	42"(1067mm)	49.77"(1264mm)	48"(1219mm)	GSJ	-4248-LNN	N	1047.23	1153.91	1548.32
55.77"(1417mm)		54"(1372mm)	GSJ	-4254-LNN	N	1093.22	1213.23	1648.81	1768.82
61.77"(1569mm)		60"(1524mm)	GSJ	-4260-LNN	N	1139.21	1272.56	1749.30	1882.65
67.77"(1721mm)		66"(1676mm)	GSJ	-4266-LNN	N	1185.20	1331.88	1849.79	1996.47
73.77"(1874mm)		72"(1829mm)	GSJ	-4272-LNN	N	1231.19	1391.21	1950.28	2110.30
79.77"(2026mm)		78"(1981mm)	GSJ	-4278-LNN	N	1277.18	1450.53	2050.77	2224.12
85.77"(2179mm)		84"(2134mm)	GSJ	-4284-LNN	N	1323.17	1509.86	2151.26	2337.95
91.77"(2331mm)		90"(2286mm)	GSJ	-4290-LNN	N	1369.16	1569.18	2251.75	2451.77
97.77"(2483mm)		96"(2438mm)	GSJ	-4296-LNN	N	1415.15	1628.51	2352.24	2565.60
103.77"(2636mm)		102"(2591mm)	GSJ	-42A2-LNN	N	1461.14	1687.83	2452.73	2679.42
109.77"(2788mm)		108"(2743mm)	GSJ	-42A8-LNN	N	1507.13	1747.16	2553.22	2793.25
115.77"(2941mm)		114"(2896mm)	GSJ	-42B4-LNN	N	1553.12	1806.48	2653.71	2907.07
50"(1270mm)		49.77"(1264mm)	48"(1219mm)	GSJ	-5048-LNN	N	1117.31	1244.31	1618.40
	55.77"(1417mm)	54"(1372mm)	GSJ	-5054-LNN	N	1172.06	1314.93	1727.65	1870.52
	61.77"(1569mm)	60"(1524mm)	GSJ	-5060-LNN	N	1226.81	1385.56	1836.90	1995.65
	67.77"(1721mm)	66"(1676mm)	GSJ	-5066-LNN	N	1281.56	1456.18	1946.15	2120.77
	73.77"(1874mm)	72"(1829mm)	GSJ	-5072-LNN	N	1336.31	1526.81	2055.40	2245.90
	79.77"(2026mm)	78"(1981mm)	GSJ	-5078-LNN	N	1391.06	1597.44	2164.65	2371.03
	85.77"(2179mm)	84"(2134mm)	GSJ	-5084-LNN	N	1445.81	1668.06	2273.90	2496.15
	91.77"(2331mm)	90"(2286mm)	GSJ	-5090-LNN	N	1500.56	1738.68	2383.15	2621.27
	97.77"(2483mm)	96"(2438mm)	GSJ	-5096-LNN	N	1555.31	1809.31	2492.40	2746.40
	103.77"(2636mm)	102"(2591mm)	GSJ	-50A2-LNN	N	1610.06	1879.93	2601.65	2871.52
	109.77"(2788mm)	108"(2743mm)	GSJ	-50A8-LNN	N	1664.81	1950.56	2710.90	2996.65
	115.77"(2941mm)	114"(2896mm)	GSJ	-50B4-LNN	N	1719.56	2021.19	2820.15	3121.78

Panel to Panel Face Attachment

K/J (Left or Right Full Face Connection Mount with Half Mount)

Nominal Height	Actual Width	Nominal Width	Number		No Glass HPL		Glass Ready HPL		
			①②	③	A	B	A	B	
K Option (LH Full Face Connection/RH Half Face Connection)									
34"(864mm)	49.77"(1264mm)	48"(1219mm)	GSKBB-3448-LNN	N	977.15	1063.51	1478.24	1564.60	
	55.77"(1417mm)	54"(1372mm)	GSKBB-3454-LNN	N	1014.38	1111.53	1569.97	1667.12	
	61.77"(1569mm)	60"(1524mm)	GSKBB-3460-LNN	N	1051.61	1159.56	1661.70	1769.65	
	67.77"(1721mm)	66"(1676mm)	GSKBB-3466-LNN	N	1088.84	1207.59	1753.43	1872.18	
	73.77"(1874mm)	72"(1829mm)	GSKBB-3472-LNN	N	1126.07	1255.61	1845.16	1974.70	
	79.77"(2026mm)	78"(1981mm)	GSKBB-3478-LNN	N	1163.30	1303.63	1936.89	2077.22	
	85.77"(2179mm)	84"(2134mm)	GSKBB-3484-LNN	N	1200.53	1351.66	2028.62	2179.75	
	91.77"(2331mm)	90"(2286mm)	GSKBB-3490-LNN	N	1237.76	1399.68	2120.35	2282.27	
	97.77"(2483mm)	96"(2438mm)	GSKBB-3496-LNN	N	1274.99	1447.71	2212.08	2384.80	
	103.77"(2636mm)	102"(2591mm)	GSKBB-34A2-LNN	N	1312.22	1495.74	2303.81	2487.33	
	109.77"(2788mm)	108"(2743mm)	GSKBB-34A8-LNN	N	1349.45	1543.76	2395.54	2589.85	
	115.77"(2941mm)	114"(2896mm)	GSKBB-34B4-LNN	N	1386.68	1591.78	2487.27	2692.37	
42"(1067mm)	49.77"(1264mm)	48"(1219mm)	GSK	-4248-LNN	N	1047.23	1153.91	1548.32	1655.00
	55.77"(1417mm)	54"(1372mm)	GSK	-4254-LNN	N	1093.22	1213.23	1648.81	1768.82
	61.77"(1569mm)	60"(1524mm)	GSK	-4260-LNN	N	1139.21	1272.56	1749.30	1882.65
	67.77"(1721mm)	66"(1676mm)	GSK	-4266-LNN	N	1185.20	1331.88	1849.79	1996.47
	73.77"(1874mm)	72"(1829mm)	GSK	-4272-LNN	N	1231.19	1391.21	1950.28	2110.30
	79.77"(2026mm)	78"(1981mm)	GSK	-4278-LNN	N	1277.18	1450.53	2050.77	2224.12
	85.77"(2179mm)	84"(2134mm)	GSK	-4284-LNN	N	1323.17	1509.86	2151.26	2337.95
	91.77"(2331mm)	90"(2286mm)	GSK	-4290-LNN	N	1369.16	1569.18	2251.75	2451.77
	97.77"(2483mm)	96"(2438mm)	GSK	-4296-LNN	N	1415.15	1628.51	2352.24	2565.60
	103.77"(2636mm)	102"(2591mm)	GSK	-42A2-LNN	N	1461.14	1687.83	2452.73	2679.42
	109.77"(2788mm)	108"(2743mm)	GSK	-42A8-LNN	N	1507.13	1747.16	2553.22	2793.25
	115.77"(2941mm)	114"(2896mm)	GSK	-42B4-LNN	N	1553.12	1806.48	2653.71	2907.07
50"(1270mm)	49.77"(1264mm)	48"(1219mm)	GSK	-5048-LNN	N	1117.31	1244.31	1618.40	1745.40
	55.77"(1417mm)	54"(1372mm)	GSK	-5054-LNN	N	1172.06	1314.93	1727.65	1870.52
	61.77"(1569mm)	60"(1524mm)	GSK	-5060-LNN	N	1226.81	1385.56	1836.90	1995.65
	67.77"(1721mm)	66"(1676mm)	GSK	-5066-LNN	N	1281.56	1456.18	1946.15	2120.77
	73.77"(1874mm)	72"(1829mm)	GSK	-5072-LNN	N	1336.31	1526.81	2055.40	2245.90
	79.77"(2026mm)	78"(1981mm)	GSK	-5078-LNN	N	1391.06	1597.44	2164.65	2371.03
	85.77"(2179mm)	84"(2134mm)	GSK	-5084-LNN	N	1445.81	1668.06	2273.90	2496.15
	91.77"(2331mm)	90"(2286mm)	GSK	-5090-LNN	N	1500.56	1738.68	2383.15	2621.27
	97.77"(2483mm)	96"(2438mm)	GSK	-5096-LNN	N	1555.31	1809.31	2492.40	2746.40
	103.77"(2636mm)	102"(2591mm)	GSK	-50A2-LNN	N	1610.06	1879.93	2601.65	2871.52
	109.77"(2788mm)	108"(2743mm)	GSK	-50A8-LNN	N	1664.81	1950.56	2710.90	2996.65
	115.77"(2941mm)	114"(2896mm)	GSK	-50B4-LNN	N	1719.56	2021.19	2820.15	3121.78

Panel to Panel Face Attachment

P (Half Left and Half Right Mount)

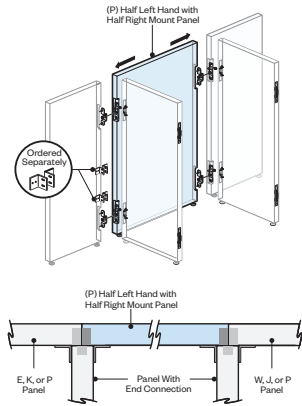

Horizontal Wood Grain



Vertical Wood Grain

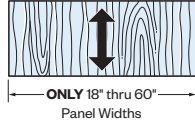

GSPB
Class BC

Feature

- Face connection adds 1.18”(30mm) to width.

Specification Tips

- Designed to connect to other panels on the face and/or end.
- Connect the Half Right to E, K, or P, and the Half Left to W, J, or P. Ensure that the inline panel heights match and that the face connections match.
- Panel has two half face (male) connections.
- **Not for use with Compose or Compose Gallery panels.**
- For attachment to other panels:
 - Separately specify one Tie Plate (ZBBP-0000-PN) to secure end-to-end panels in 180° conditions. Required at each end-to-end connection.
 - Separately specify Panel Attachment Brackets (ZUBW-0000-PN or ZUBW-0000-CN) for each 90° panel to panel condition. Each inside corner requires two Panel Attachment Brackets.
- Wood grain laminate can be vertical or horizontal. See illustrations below for limitations. Specify appropriate laminate surface code.

To Order, Specify:

1) Product number, including:

1 Face Half Connection Height (Male)

- B** 34”(864mm)H Connection
- C** 42”(1067mm)H Connection
- D** 50”(1270mm)H Connection

2 Glass Options

- N** No Glass (Finished Top)
- G** Glass Ready

2) HPL surface color.

3) Edgeband color.

Panel to Panel Face Attachment

P (Half Left and Half Right Mount)

Nominal Height	Actual Width	Nominal Width	Number		No Glass HPL		Glass Ready HPL	
			①	②	A	B	A	B
34"(864mm)	49.18"(1249mm)	48"(1219mm)	GSPB-3448-LNN	N	1599.25	1685.61	2100.34	2186.70
	55.18"(1402mm)	54"(1372mm)	GSPB-3454-LNN	N	1636.48	1733.63	2192.07	2289.22
	61.18"(1554mm)	60"(1524mm)	GSPB-3460-LNN	N	1673.71	1781.66	2283.80	2391.75
	67.18"(1706mm)	66"(1676mm)	GSPB-3466-LNN	N	1710.94	1829.69	2375.53	2494.28
	73.18"(1859mm)	72"(1829mm)	GSPB-3472-LNN	N	1748.17	1877.71	2467.26	2596.80
	79.18"(2011mm)	78"(1981mm)	GSPB-3478-LNN	N	1785.40	1925.73	2558.99	2699.32
	85.18"(2164mm)	84"(2134mm)	GSPB-3484-LNN	N	1822.63	1973.76	2650.72	2801.85
	91.18"(2316mm)	90"(2286mm)	GSPB-3490-LNN	N	1859.86	2021.78	2742.45	2904.37
	97.18"(2468mm)	96"(2438mm)	GSPB-3496-LNN	N	1897.09	2069.81	2834.18	3006.90
	103.18"(2621mm)	102"(2591mm)	GSPB-34A2-LNN	N	1934.32	2117.84	2925.91	3109.43
	109.18"(2773mm)	108"(2743mm)	GSPB-34A8-LNN	N	1971.55	2165.86	3017.64	3211.95
115.18"(2926mm)	114"(2896mm)	GSPB-34B4-LNN	N	2008.78	2213.88	3109.37	3314.47	
42"(1067mm)	49.18"(1249mm)	48"(1219mm)	GSP -4248-LNN	N	1669.33	1776.01	2170.42	2277.10
	55.18"(1402mm)	54"(1372mm)	GSP -4254-LNN	N	1715.32	1835.33	2270.91	2390.92
	61.18"(1554mm)	60"(1524mm)	GSP -4260-LNN	N	1761.31	1894.66	2371.40	2504.75
	67.18"(1706mm)	66"(1676mm)	GSP -4266-LNN	N	1807.30	1953.98	2471.89	2618.57
	73.18"(1859mm)	72"(1829mm)	GSP -4272-LNN	N	1853.29	2013.31	2572.38	2732.40
	79.18"(2011mm)	78"(1981mm)	GSP -4278-LNN	N	1899.28	2072.63	2672.87	2846.22
	85.18"(2164mm)	84"(2134mm)	GSP -4284-LNN	N	1945.27	2131.96	2773.36	2960.05
	91.18"(2316mm)	90"(2286mm)	GSP -4290-LNN	N	1991.26	2191.28	2873.85	3073.87
	97.18"(2468mm)	96"(2438mm)	GSP -4296-LNN	N	2037.25	2250.61	2974.34	3187.70
	103.18"(2621mm)	102"(2591mm)	GSP -42A2-LNN	N	2083.24	2309.93	3074.83	3301.52
	109.18"(2773mm)	108"(2743mm)	GSP -42A8-LNN	N	2129.23	2369.26	3175.32	3415.35
115.18"(2926mm)	114"(2896mm)	GSP -42B4-LNN	N	2175.22	2428.58	3275.81	3529.17	
50"(1270mm)	49.18"(1249mm)	48"(1219mm)	GSP -5048-LNN	N	1739.41	1866.41	2240.50	2367.50
	55.18"(1402mm)	54"(1372mm)	GSP -5054-LNN	N	1794.16	1937.03	2349.75	2492.62
	61.18"(1554mm)	60"(1524mm)	GSP -5060-LNN	N	1848.91	2007.66	2459.00	2617.75
	67.18"(1706mm)	66"(1676mm)	GSP -5066-LNN	N	1903.66	2078.28	2568.25	2742.87
	73.18"(1859mm)	72"(1829mm)	GSP -5072-LNN	N	1958.41	2148.91	2677.50	2868.00
	79.18"(2011mm)	78"(1981mm)	GSP -5078-LNN	N	2013.16	2219.54	2786.75	2993.13
	85.18"(2164mm)	84"(2134mm)	GSP -5084-LNN	N	2067.91	2290.16	2896.00	3118.25
	91.18"(2316mm)	90"(2286mm)	GSP -5090-LNN	N	2122.66	2360.78	3005.25	3243.37
	97.18"(2468mm)	96"(2438mm)	GSP -5096-LNN	N	2177.41	2431.41	3114.50	3368.50
	103.18"(2621mm)	102"(2591mm)	GSP -50A2-LNN	N	2232.16	2502.03	3223.75	3493.62
	109.18"(2773mm)	108"(2743mm)	GSP -50A8-LNN	N	2286.91	2572.66	3333.00	3618.75
115.18"(2926mm)	114"(2896mm)	GSP -50B4-LNN	N	2341.66	2643.29	3442.25	3743.88	

Panel to Panel Face Attachment U (Left and Right Mounts)

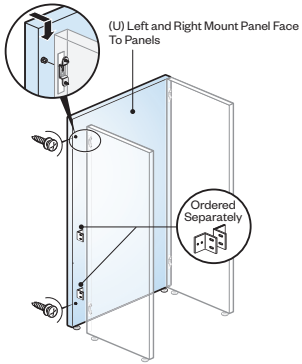

Feature

- Face connections add 2.36"(60mm) to width.

Specification Tips

- Designed to connect to two other panels on the face.
- Panel has one left face (male) and one right face (male) connection.
- **Not for use with Compose or Compose Gallery panels.**
- For attachment to other panels:
 - Separately specify one Tie Plate (ZBBP-0000-PN) to secure end-to-end panels in 180° conditions. Required at each end-to-end connection.
 - Separately specify Panel Attachment Brackets (ZUBW-0000-PN or ZUBW-0000-CN) for each 90° panel to panel condition. Each inside corner requires two Panel Attachment Brackets.
- Wood grain laminate can be vertical or horizontal. See illustrations below for limitations. Specify appropriate laminate surface code.

To Order, Specify:

1) Product number, including:

1 Face Connection Height (Male)

- B** 34"(864mm)H Connection
- C** 42"(1067mm)H Connection
- D** 50"(1270mm)H Connection

2 Glass Options

- N** No Glass (Finished Top)
- G** Glass Ready

2) HPL surface color.

3) Edgeband color.

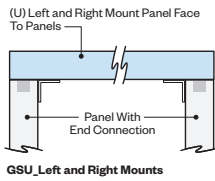

GSU_Left and Right Mounts

Horizontal Wood Grain



Vertical Wood Grain

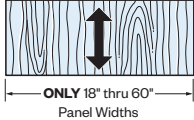

GSUB
Class BC

Panel to Panel Face Attachment

U (Left and Right Mounts)

Nominal Height	Actual Width	Nominal Width	Number		No Glass HPL		Glass Ready HPL	
			①	②	A	B	A	B
34"(864mm)	50.36"(1279mm)	48"(1219mm)	GSUB-3448-LNN	N	1303.51	1389.87	1804.60	1890.96
	56.36"(1432mm)	54"(1372mm)	GSUB-3454-LNN	N	1340.74	1437.89	1896.33	1993.48
	62.36"(1584mm)	60"(1524mm)	GSUB-3460-LNN	N	1377.97	1485.92	1988.06	2096.01
	68.36"(1736mm)	66"(1676mm)	GSUB-3466-LNN	N	1415.20	1533.95	2079.79	2198.54
	74.36"(1889mm)	72"(1829mm)	GSUB-3472-LNN	N	1452.43	1581.97	2171.52	2301.06
	80.36"(2041mm)	78"(1981mm)	GSUB-3478-LNN	N	1489.66	1629.99	2263.25	2403.58
	86.36"(2194mm)	84"(2134mm)	GSUB-3484-LNN	N	1526.89	1678.02	2354.98	2506.11
	92.36"(2346mm)	90"(2286mm)	GSUB-3490-LNN	N	1564.12	1726.04	2446.71	2608.63
	98.36"(2498mm)	96"(2438mm)	GSUB-3496-LNN	N	1601.35	1774.07	2538.44	2711.16
	104.36"(2651mm)	102"(2591mm)	GSUB-34A2-LNN	N	1638.58	1822.10	2630.17	2813.69
	110.36"(2803mm)	108"(2743mm)	GSUB-34A8-LNN	N	1675.81	1870.12	2721.90	2916.21
	116.36"(2956mm)	114"(2896mm)	GSUB-34B4-LNN	N	1713.04	1918.14	2813.63	3018.73
42"(1067mm)	50.36"(1279mm)	48"(1219mm)	GSU -4248-LNN	N	1373.59	1480.27	1874.68	1981.36
	56.36"(1432mm)	54"(1372mm)	GSU -4254-LNN	N	1419.58	1539.59	1975.17	2095.18
	62.36"(1584mm)	60"(1524mm)	GSU -4260-LNN	N	1465.57	1598.92	2075.66	2209.01
	68.36"(1736mm)	66"(1676mm)	GSU -4266-LNN	N	1511.56	1658.24	2176.15	2322.83
	74.36"(1889mm)	72"(1829mm)	GSU -4272-LNN	N	1557.55	1717.57	2276.64	2436.66
	80.36"(2041mm)	78"(1981mm)	GSU -4278-LNN	N	1603.54	1776.89	2377.13	2550.48
	86.36"(2194mm)	84"(2134mm)	GSU -4284-LNN	N	1649.53	1836.22	2477.62	2664.31
	92.36"(2346mm)	90"(2286mm)	GSU -4290-LNN	N	1695.52	1895.54	2578.11	2778.13
	98.36"(2498mm)	96"(2438mm)	GSU -4296-LNN	N	1741.51	1954.87	2678.60	2891.96
	104.36"(2651mm)	102"(2591mm)	GSU -42A2-LNN	N	1787.50	2014.19	2779.09	3005.78
	110.36"(2803mm)	108"(2743mm)	GSU -42A8-LNN	N	1833.49	2073.52	2879.58	3119.61
	116.36"(2956mm)	114"(2896mm)	GSU -42B4-LNN	N	1879.48	2132.84	2980.07	3233.43
50"(1270mm)	50.36"(1279mm)	48"(1219mm)	GSU -5048-LNN	N	1443.67	1570.67	1944.76	2071.76
	56.36"(1432mm)	54"(1372mm)	GSU -5054-LNN	N	1498.42	1641.29	2054.01	2196.88
	62.36"(1584mm)	60"(1524mm)	GSU -5060-LNN	N	1553.17	1711.92	2163.26	2322.01
	68.36"(1736mm)	66"(1676mm)	GSU -5066-LNN	N	1607.92	1782.54	2272.51	2447.13
	74.36"(1889mm)	72"(1829mm)	GSU -5072-LNN	N	1662.67	1853.17	2381.76	2572.26
	80.36"(2041mm)	78"(1981mm)	GSU -5078-LNN	N	1717.42	1923.80	2491.01	2697.39
	86.36"(2194mm)	84"(2134mm)	GSU -5084-LNN	N	1772.17	1994.42	2600.26	2822.51
	92.36"(2346mm)	90"(2286mm)	GSU -5090-LNN	N	1826.92	2065.04	2709.51	2947.63
	98.36"(2498mm)	96"(2438mm)	GSU -5096-LNN	N	1881.67	2135.67	2818.76	3072.76
	104.36"(2651mm)	102"(2591mm)	GSU -50A2-LNN	N	1936.42	2206.29	2928.01	3197.88
	110.36"(2803mm)	108"(2743mm)	GSU -50A8-LNN	N	1991.17	2276.92	3037.26	3323.01
	116.36"(2956mm)	114"(2896mm)	GSU -50B4-LNN	N	2045.92	2347.55	3146.51	3448.14

Panel to Panel Face Attachment

T (Two-Sided Left/Right Mount)

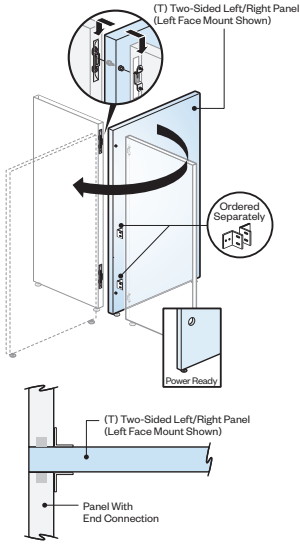

Features

- Face connections add 1.18”(30mm) to width.
- Spine adjacent pass-through at power shroud height. See product details for exact locations and dimensions for each panel configuration.

Specification Tips

- Designed to connect between two other panels on the face.
- Panel has two face (male) and one optional end (female) connections.
- **Not for use with Compose or Compose Gallery panels.**
- For attachment to other panels:
 - Separately specify one Tie Plate (ZBBP-0000-PN) to secure end-to-end panels in 180° conditions. Required at each end-to-end connection.
 - Separately specify Panel Attachment Brackets (ZUBW-0000-PN or ZUBW-0000-CN) for each 90° panel to panel condition. Each inside corner requires two Panel Attachment Brackets.
- Wood grain laminate can be vertical or horizontal. See illustrations below for limitations. Specify appropriate laminate surface code.

To Order, Specify:

1) Product number, including:

1 Face Connection Height (Male)

- B** 34”(864mm)H Connection
- C** 42”(1067mm)H Connection
- D** 50”(1270mm)H Connection

2 Other End (Finished End or Connection End) (Female)

- N** No Connection (Finished End)
- B** 34”(864mm)H Connection
- C** 42”(1067mm)H Connection
- D** 50”(1270mm)H Connection

3 Glass Options

- N** No Glass (Finished Top)
- G** Glass Ready

4 Power Pass-through (Return Applications ONLY)

- N** No Pass-through
- P** Power Pass-through

- 2) HPL surface color.
- 3) Edgeband color.

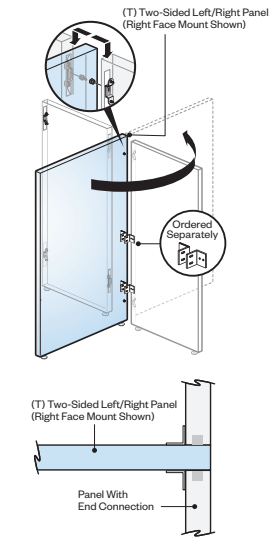

Horizontal Wood Grain

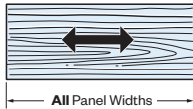

Vertical Wood Grain

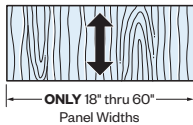

GSTB
Class BC

Panel to Panel Face Attachment T (Two-Sided Left/Right Mount)

Nominal Height	Actual Width	Nominal Width	Number			No Glass HPL		Glass Ready HPL	
			①	②③④	A	B	A	B	
34"(864mm)	19.18"(487mm)	18"(457mm)	GSTB-3418-LN	■ ■ ■ ■	\$891.32	\$923.70	\$1119.91	\$1152.29	
	25.18"(640mm)	24"(610mm)	GSTB-3424-LN	■ ■ ■ ■	928.55	971.73	1211.64	1254.82	
	31.18"(792mm)	30"(762mm)	GSTB-3430-LN	■ ■ ■ ■	965.78	1019.76	1303.37	1357.35	
	37.18"(944mm)	36"(914mm)	GSTB-3436-LN	■ ■ ■ ■	1158.45	1223.22	1550.54	1615.31	
	43.18"(1097mm)	42"(1067mm)	GSTB-3442-LN	■ ■ ■ ■	1292.83	1368.39	1739.42	1814.98	
	49.18"(1249mm)	48"(1219mm)	GSTB-3448-LN	■ ■ ■ ■	1330.06	1416.42	1831.15	1917.51	
	55.18"(1402mm)	54"(1372mm)	GSTB-3454-LN	■ ■ ■ ■	1367.29	1464.44	1922.88	2020.03	
	61.18"(1554mm)	60"(1524mm)	GSTB-3460-LN	■ ■ ■ ■	1404.52	1512.47	2014.61	2122.56	
	67.18"(1706mm)	66"(1676mm)	GSTB-3466-LN	■ ■ ■ ■	1441.75	1560.50	2106.34	2225.09	
	73.18"(1859mm)	72"(1829mm)	GSTB-3472-LN	■ ■ ■ ■	1478.98	1608.52	2198.07	2327.61	
	79.18"(2011mm)	78"(1981mm)	GSTB-3478-LN	■ ■ ■ ■	1516.21	1656.54	2289.80	2430.13	
	85.18"(2164mm)	84"(2134mm)	GSTB-3484-LN	■ ■ ■ ■	1553.44	1704.57	2381.53	2532.66	
	91.18"(2316mm)	90"(2286mm)	GSTB-3490-LN	■ ■ ■ ■	1590.67	1752.59	2473.26	2635.18	
	97.18"(2468mm)	96"(2438mm)	GSTB-3496-LN	■ ■ ■ ■	1627.90	1800.62	2564.99	2737.71	
103.18"(2621mm)	102"(2591mm)	GSTB-34A2-LN	■ ■ ■ ■	1665.13	1848.65	2656.72	2840.24		
109.18"(2773mm)	108"(2743mm)	GSTB-34A8-LN	■ ■ ■ ■	1702.36	1896.67	2748.45	2942.76		
115.18"(2926mm)	114"(2896mm)	GSTB-34B4-LN	■ ■ ■ ■	1739.59	1944.69	2840.18	3045.28		
42"(1067mm)	19.18"(487mm)	18"(457mm)	GST -4218-LN	■ ■ ■ ■	\$ 917.60	\$ 957.60	\$ 1146.19	\$ 1186.19	
	25.18"(640mm)	24"(610mm)	GST -4224-LN	■ ■ ■ ■	963.59	1016.93	1246.68	1300.02	
	31.18"(792mm)	30"(762mm)	GST -4230-LN	■ ■ ■ ■	1009.58	1076.25	1347.17	1413.84	
	37.18"(944mm)	36"(914mm)	GST -4236-LN	■ ■ ■ ■	1211.01	1291.02	1603.10	1683.11	
	43.18"(1097mm)	42"(1067mm)	GST -4242-LN	■ ■ ■ ■	1354.15	1447.49	1800.74	1894.08	
	49.18"(1249mm)	48"(1219mm)	GST -4248-LN	■ ■ ■ ■	1400.14	1506.82	1901.23	2007.91	
	55.18"(1402mm)	54"(1372mm)	GST -4254-LN	■ ■ ■ ■	1446.13	1566.14	2001.72	2121.73	
	61.18"(1554mm)	60"(1524mm)	GST -4260-LN	■ ■ ■ ■	1492.12	1625.47	2102.21	2235.56	
	67.18"(1706mm)	66"(1676mm)	GST -4266-LN	■ ■ ■ ■	1538.11	1684.79	2202.70	2349.38	
	73.18"(1859mm)	72"(1829mm)	GST -4272-LN	■ ■ ■ ■	1584.10	1744.12	2303.19	2463.21	
	79.18"(2011mm)	78"(1981mm)	GST -4278-LN	■ ■ ■ ■	1630.09	1803.44	2403.68	2577.03	
	85.18"(2164mm)	84"(2134mm)	GST -4284-LN	■ ■ ■ ■	1676.08	1862.77	2504.17	2690.86	
	91.18"(2316mm)	90"(2286mm)	GST -4290-LN	■ ■ ■ ■	1722.07	1922.09	2604.66	2804.68	
	97.18"(2468mm)	96"(2438mm)	GST -4296-LN	■ ■ ■ ■	1768.06	1981.42	2705.15	2918.51	
103.18"(2621mm)	102"(2591mm)	GST -42A2-LN	■ ■ ■ ■	1814.05	2040.74	2805.64	3032.33		
109.18"(2773mm)	108"(2743mm)	GST -42A8-LN	■ ■ ■ ■	1860.04	2100.07	2906.13	3146.16		
115.18"(2926mm)	114"(2896mm)	GST -42B4-LN	■ ■ ■ ■	1906.03	2159.39	3006.62	3259.98		
50"(1270mm)	19.18"(487mm)	18"(457mm)	GST -5018-LN	■ ■ ■ ■	\$ 943.88	\$ 991.50	\$ 1172.47	\$ 1220.09	
	25.18"(640mm)	24"(610mm)	GST -5024-LN	■ ■ ■ ■	998.63	1062.13	1281.72	1345.22	
	31.18"(792mm)	30"(762mm)	GST -5030-LN	■ ■ ■ ■	1053.38	1132.75	1390.97	1470.34	
	37.18"(944mm)	36"(914mm)	GST -5036-LN	■ ■ ■ ■	1263.57	1358.82	1655.66	1750.91	
	43.18"(1097mm)	42"(1067mm)	GST -5042-LN	■ ■ ■ ■	1415.47	1526.60	1862.06	1973.19	
	49.18"(1249mm)	48"(1219mm)	GST -5048-LN	■ ■ ■ ■	1470.22	1597.22	1971.31	2098.31	
	55.18"(1402mm)	54"(1372mm)	GST -5054-LN	■ ■ ■ ■	1524.97	1667.84	2080.56	2223.43	
	61.18"(1554mm)	60"(1524mm)	GST -5060-LN	■ ■ ■ ■	1579.72	1738.47	2189.81	2348.56	
	67.18"(1706mm)	66"(1676mm)	GST -5066-LN	■ ■ ■ ■	1634.47	1809.09	2299.06	2473.68	
	73.18"(1859mm)	72"(1829mm)	GST -5072-LN	■ ■ ■ ■	1689.22	1879.72	2408.31	2598.81	
	79.18"(2011mm)	78"(1981mm)	GST -5078-LN	■ ■ ■ ■	1743.97	1950.35	2517.56	2723.94	
	85.18"(2164mm)	84"(2134mm)	GST -5084-LN	■ ■ ■ ■	1798.72	2020.97	2626.81	2849.06	
	91.18"(2316mm)	90"(2286mm)	GST -5090-LN	■ ■ ■ ■	1853.47	2091.59	2736.06	2974.18	
	97.18"(2468mm)	96"(2438mm)	GST -5096-LN	■ ■ ■ ■	1908.22	2162.22	2845.31	3099.31	
103.18"(2621mm)	102"(2591mm)	GST -50A2-LN	■ ■ ■ ■	1962.97	2232.84	2954.56	3224.43		
109.18"(2773mm)	108"(2743mm)	GST -50A8-LN	■ ■ ■ ■	2017.72	2303.47	3063.81	3349.56		
115.18"(2926mm)	114"(2896mm)	GST -50B4-LN	■ ■ ■ ■	2072.47	2374.10	3173.06	3474.69		

Panel to Panel Face Attachment H (Two-Sided Half Left/Right Mount)

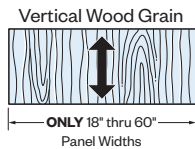
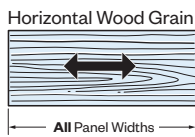
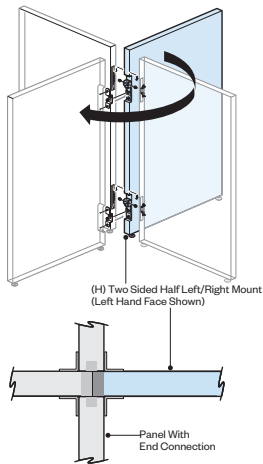
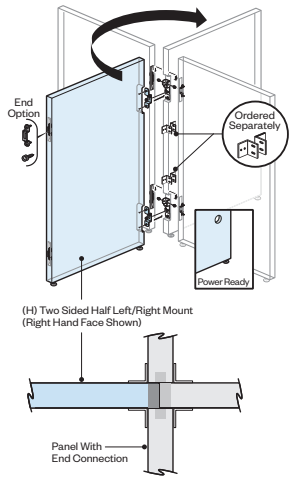

GSHB
Class BC

Features

- Face connections add 0.59”(15mm) to width.
- Spine adjacent pass-through at power shroud height. See product details for exact locations and dimensions for each panel configuration.

Specification Tips

- Designed to connect to other panels on the face and/or end.
- The half face connection requires another Two-Sided Half Mount panel type (D or H) for this application. Panel heights must match, widths may be different.
- Panel has four half face (male) connections, two each side.
- Face attachment for use at the end of a panel.
- **Not for use with Compose or Compose Gallery panels.**
- For attachment to other panels:
 - Separately specify one Tie Plate (ZBBP-0000-PN) to secure end-to-end panels in 180° conditions. Required at each end-to-end connection.
 - Separately specify Panel Attachment Brackets (ZUBW-0000-PN or ZUBW-0000-CN) for each 90° panel to panel condition. Each inside corner requires two Panel Attachment Brackets.
- Wood grain laminate can be vertical or horizontal. See illustrations below for limitations. Specify appropriate laminate surface code.

To Order, Specify:

1) Product number, including:

1 Face Half Connection Height (Male)

- B** 34”(864mm)H Connection
- C** 42”(1067mm)H Connection
- D** 50”(1270mm)H Connection

2 Other End (Finished End or Connection End) (Female)

- N** No Connection (Finished End)
- B** 34”(864mm)H Connection
- C** 42”(1067mm)H Connection
- D** 50”(1270mm)H Connection

3 Glass Options

- N** No Glass (Finished Top)
- G** Glass Ready

4 Power Pass-through (Return Applications ONLY)

- N** No Pass-through
- P** Power Pass-through

2) HPL surface color.

3) Edgeband color.

Panel to Panel Face Attachment

H (Two-Sided Half Left/Right Mount)

Nominal Height	Actual Width	Nominal Width	Number				No Glass HPL		Glass Ready HPL		
			①	②	③	④	A	B	A	B	
34"(864mm)	19.59"(498mm)	18"(457mm)	GSHB-3418-LN	■	■	■	■	\$1039.19	\$1071.57	\$1267.78	\$1300.16
	25.59"(650mm)	24"(610mm)	GSHB-3424-LN	■	■	■	■	1076.42	1119.60	1359.51	1402.69
	31.59"(802mm)	30"(762mm)	GSHB-3430-LN	■	■	■	■	1113.65	1167.63	1451.24	1505.22
	37.59"(955mm)	36"(914mm)	GSHB-3436-LN	■	■	■	■	1306.32	1371.09	1698.41	1763.18
	43.59"(1107mm)	42"(1067mm)	GSHB-3442-LN	■	■	■	■	1440.70	1516.26	1887.29	1962.85
	49.59"(1260mm)	48"(1219mm)	GSHB-3448-LN	■	■	■	■	1477.93	1564.29	1979.02	2065.38
	55.59"(1412mm)	54"(1372mm)	GSHB-3454-LN	■	■	■	■	1515.16	1612.31	2070.75	2167.90
	61.59"(1564mm)	60"(1524mm)	GSHB-3460-LN	■	■	■	■	1552.39	1660.34	2162.48	2270.43
	67.59"(1717mm)	66"(1676mm)	GSHB-3466-LN	■	■	■	■	1589.62	1708.37	2254.21	2372.96
	73.59"(1869mm)	72"(1829mm)	GSHB-3472-LN	■	■	■	■	1626.85	1756.39	2345.94	2475.48
	79.59"(2022mm)	78"(1981mm)	GSHB-3478-LN	■	■	■	■	1664.08	1804.41	2437.67	2578.00
	85.59"(2174mm)	84"(2134mm)	GSHB-3484-LN	■	■	■	■	1701.31	1852.44	2529.40	2680.53
	91.59"(2326mm)	90"(2286mm)	GSHB-3490-LN	■	■	■	■	1738.54	1900.46	2621.13	2783.05
97.59"(2479mm)	96"(2438mm)	GSHB-3496-LN	■	■	■	■	1775.77	1948.49	2712.86	2885.58	
103.59"(2631mm)	102"(2591mm)	GSHB-34A2-LN	■	■	■	■	1813.00	1996.52	2804.59	2988.11	
109.59"(2784mm)	108"(2743mm)	GSHB-34A8-LN	■	■	■	■	1850.23	2044.54	2896.32	3090.63	
115.59"(2936mm)	114"(2896mm)	GSHB-34B4-LN	■	■	■	■	1887.46	2092.56	2988.05	3193.15	
42"(1067mm)	19.59"(498mm)	18"(457mm)	GSH -4218-LN	■	■	■	■	\$ 1065.47	\$ 1105.47	\$ 1294.06	\$ 1334.06
	25.59"(650mm)	24"(610mm)	GSH -4224-LN	■	■	■	■	1111.46	1164.80	1394.55	1447.89
	31.59"(802mm)	30"(762mm)	GSH -4230-LN	■	■	■	■	1157.45	1224.12	1495.04	1561.71
	37.59"(955mm)	36"(914mm)	GSH -4236-LN	■	■	■	■	1358.88	1438.89	1750.97	1830.98
	43.59"(1107mm)	42"(1067mm)	GSH -4242-LN	■	■	■	■	1502.02	1595.36	1948.61	2041.95
	49.59"(1260mm)	48"(1219mm)	GSH -4248-LN	■	■	■	■	1548.01	1654.69	2049.10	2155.78
	55.59"(1412mm)	54"(1372mm)	GSH -4254-LN	■	■	■	■	1594.00	1714.01	2149.59	2269.60
	61.59"(1564mm)	60"(1524mm)	GSH -4260-LN	■	■	■	■	1639.99	1773.34	2250.08	2383.43
	67.59"(1717mm)	66"(1676mm)	GSH -4266-LN	■	■	■	■	1685.98	1832.66	2350.57	2497.25
	73.59"(1869mm)	72"(1829mm)	GSH -4272-LN	■	■	■	■	1731.97	1891.99	2451.06	2611.08
	79.59"(2022mm)	78"(1981mm)	GSH -4278-LN	■	■	■	■	1777.96	1951.31	2551.55	2724.90
	85.59"(2174mm)	84"(2134mm)	GSH -4284-LN	■	■	■	■	1823.95	2010.64	2652.04	2838.73
	91.59"(2326mm)	90"(2286mm)	GSH -4290-LN	■	■	■	■	1869.94	2069.96	2752.53	2952.55
97.59"(2479mm)	96"(2438mm)	GSH -4296-LN	■	■	■	■	1915.93	2129.29	2853.02	3066.38	
103.59"(2631mm)	102"(2591mm)	GSH -42A2-LN	■	■	■	■	1961.92	2188.61	2953.51	3180.20	
109.59"(2784mm)	108"(2743mm)	GSH -42A8-LN	■	■	■	■	2007.91	2247.94	3054.00	3294.03	
115.59"(2936mm)	114"(2896mm)	GSH -42B4-LN	■	■	■	■	2053.90	2307.26	3154.49	3407.85	
50"(1270mm)	19.59"(498mm)	18"(457mm)	GSH -5018-LN	■	■	■	■	\$ 1091.75	\$ 1139.37	\$ 1320.34	\$ 1367.96
	25.59"(650mm)	24"(610mm)	GSH -5024-LN	■	■	■	■	1146.50	1210.00	1429.59	1493.09
	31.59"(802mm)	30"(762mm)	GSH -5030-LN	■	■	■	■	1201.25	1280.62	1538.84	1618.21
	37.59"(955mm)	36"(914mm)	GSH -5036-LN	■	■	■	■	1411.44	1506.69	1803.53	1898.78
	43.59"(1107mm)	42"(1067mm)	GSH -5042-LN	■	■	■	■	1563.34	1674.47	2009.93	2121.06
	49.59"(1260mm)	48"(1219mm)	GSH -5048-LN	■	■	■	■	1618.09	1745.09	2119.18	2246.18
	55.59"(1412mm)	54"(1372mm)	GSH -5054-LN	■	■	■	■	1672.84	1815.71	2228.43	2371.30
	61.59"(1564mm)	60"(1524mm)	GSH -5060-LN	■	■	■	■	1727.59	1886.34	2337.68	2496.43
	67.59"(1717mm)	66"(1676mm)	GSH -5066-LN	■	■	■	■	1782.34	1956.96	2446.93	2621.55
	73.59"(1869mm)	72"(1829mm)	GSH -5072-LN	■	■	■	■	1837.09	2027.59	2556.18	2746.68
	79.59"(2022mm)	78"(1981mm)	GSH -5078-LN	■	■	■	■	1891.84	2098.22	2665.43	2871.81
	85.59"(2174mm)	84"(2134mm)	GSH -5084-LN	■	■	■	■	1946.59	2168.84	2774.68	2996.93
	91.59"(2326mm)	90"(2286mm)	GSH -5090-LN	■	■	■	■	2001.34	2239.46	2883.93	3122.05
97.59"(2479mm)	96"(2438mm)	GSH -5096-LN	■	■	■	■	2056.09	2310.09	2993.18	3247.18	
103.59"(2631mm)	102"(2591mm)	GSH -50A2-LN	■	■	■	■	2110.84	2380.71	3102.43	3372.30	
109.59"(2784mm)	108"(2743mm)	GSH -50A8-LN	■	■	■	■	2165.59	2451.34	3211.68	3497.43	
115.59"(2936mm)	114"(2896mm)	GSH -50B4-LN	■	■	■	■	2220.34	2521.97	3320.93	3622.56	

Panel to Panel Face Attachment X (Two-Sided Center Mount)

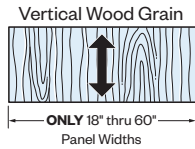
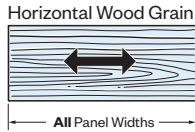
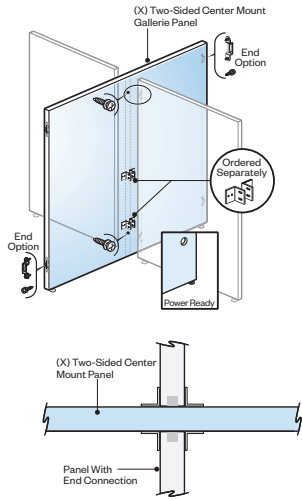

GSXB
Class BC

Features

- Face connections add 1.18”(30mm) to width.
- Spine adjacent pass-throughs at power shroud height. See product details for exact locations and dimensions for each panel configuration.

Specification Tips

- Designed to connect to other panels on the face and/or ends.
- Panel has two face (male) and two optional end (female) connections.
- **Not for use with Compose or Compose Gallery panels.**
- For attachment to other panels:
 - Separately specify one Tie Plate (ZBBP-0000-PN) to secure end-to-end panels in 180° conditions. Required at each end-to-end connection.
 - Separately specify Panel Attachment Brackets (ZUBW-0000-PN or ZUBW-0000-CN) for each 90° panel to panel condition. Each inside corner requires two Panel Attachment Brackets.
- Wood grain laminate can be vertical or horizontal. See illustrations below for limitations. Specify appropriate laminate surface code.

To Order, Specify:

1) Product number, including:

1 Face Connection Height (Male)

- B** 34”(864mm)H Connection
- C** 42”(1067mm)H Connection
- D** 50”(1270mm)H Connection

2 First End (Finished End or Connection End) (Female)

- N** No Connection (Finished End)
- B** 34”(864mm)H Connection
- C** 42”(1067mm)H Connection
- D** 50”(1270mm)H Connection

3 Other End (Finished End or Connection End) (Female)

- N** No Connection (Finished End)
- B** 34”(864mm)H Connection
- C** 42”(1067mm)H Connection
- D** 50”(1270mm)H Connection

4 Glass Options

- N** No Glass (Finished Top)
- G** Glass Ready

5 Power Pass-through (Return Applications ONLY)

- N** No Pass-through
- P** Power Pass-through

2) HPL surface color.

3) Edgeband color.

Panel to Panel Face Attachment X (Two-Sided Center Mount)

Nominal Height	Actual Width	Nominal Width	Number		No Glass HPL		Glass Ready HPL	
			①	②③④⑤	A	B	A	B
34"(864mm)	19.18"(487mm)	18"(457mm)	GSXB-3418-L	■ ■ ■ ■ ■	\$891.32	\$923.70	\$1119.91	\$1152.29
	25.18"(640mm)	24"(610mm)	GSXB-3424-L	■ ■ ■ ■ ■	928.55	971.73	1211.64	1254.82
	31.18"(792mm)	30"(762mm)	GSXB-3430-L	■ ■ ■ ■ ■	965.78	1019.76	1303.37	1357.35
	37.18"(944mm)	36"(914mm)	GSXB-3436-L	■ ■ ■ ■ ■	1158.45	1223.22	1550.54	1615.31
	43.18"(1097mm)	42"(1067mm)	GSXB-3442-L	■ ■ ■ ■ ■	1292.83	1368.39	1739.42	1814.98
	49.18"(1249mm)	48"(1219mm)	GSXB-3448-L	■ ■ ■ ■ ■	1330.06	1416.42	1831.15	1917.51
	55.18"(1402mm)	54"(1372mm)	GSXB-3454-L	■ ■ ■ ■ ■	1367.29	1464.44	1922.88	2020.03
	61.18"(1554mm)	60"(1524mm)	GSXB-3460-L	■ ■ ■ ■ ■	1404.52	1512.47	2014.61	2122.56
	67.18"(1706mm)	66"(1676mm)	GSXB-3466-L	■ ■ ■ ■ ■	1441.75	1560.50	2106.34	2225.09
	73.18"(1859mm)	72"(1829mm)	GSXB-3472-L	■ ■ ■ ■ ■	1478.98	1608.52	2198.07	2327.61
	79.18"(2011mm)	78"(1981mm)	GSXB-3478-L	■ ■ ■ ■ ■	1516.21	1656.54	2289.80	2430.13
	85.18"(2164mm)	84"(2134mm)	GSXB-3484-L	■ ■ ■ ■ ■	1553.44	1704.57	2381.53	2532.66
	91.18"(2316mm)	90"(2286mm)	GSXB-3490-L	■ ■ ■ ■ ■	1590.67	1752.59	2473.26	2635.18
	97.18"(2468mm)	96"(2438mm)	GSXB-3496-L	■ ■ ■ ■ ■	1627.90	1800.62	2564.99	2737.71
103.18"(2621mm)	102"(2591mm)	GSXB-34A2-L	■ ■ ■ ■ ■	1665.13	1848.65	2656.72	2840.24	
109.18"(2773mm)	108"(2743mm)	GSXB-34A8-L	■ ■ ■ ■ ■	1702.36	1896.67	2748.45	2942.76	
115.18"(2926mm)	114"(2896mm)	GSXB-34B4-L	■ ■ ■ ■ ■	1739.59	1944.69	2840.18	3045.28	
42"(1067mm)	19.18"(487mm)	18"(457mm)	GSX -4218-L	■ ■ ■ ■ ■	\$ 917.60	\$ 957.60	\$ 1146.19	\$ 1186.19
	25.18"(640mm)	24"(610mm)	GSX -4224-L	■ ■ ■ ■ ■	963.59	1016.93	1246.68	1300.02
	31.18"(792mm)	30"(762mm)	GSX -4230-L	■ ■ ■ ■ ■	1009.58	1076.25	1347.17	1413.84
	37.18"(944mm)	36"(914mm)	GSX -4236-L	■ ■ ■ ■ ■	1211.01	1291.02	1603.10	1683.11
	43.18"(1097mm)	42"(1067mm)	GSX -4242-L	■ ■ ■ ■ ■	1354.15	1447.49	1800.74	1894.08
	49.18"(1249mm)	48"(1219mm)	GSX -4248-L	■ ■ ■ ■ ■	1400.14	1506.82	1901.23	2007.91
	55.18"(1402mm)	54"(1372mm)	GSX -4254-L	■ ■ ■ ■ ■	1446.13	1566.14	2001.72	2121.73
	61.18"(1554mm)	60"(1524mm)	GSX -4260-L	■ ■ ■ ■ ■	1492.12	1625.47	2102.21	2235.56
	67.18"(1706mm)	66"(1676mm)	GSX -4266-L	■ ■ ■ ■ ■	1538.11	1684.79	2202.70	2349.38
	73.18"(1859mm)	72"(1829mm)	GSX -4272-L	■ ■ ■ ■ ■	1584.10	1744.12	2303.19	2463.21
	79.18"(2011mm)	78"(1981mm)	GSX -4278-L	■ ■ ■ ■ ■	1630.09	1803.44	2403.68	2577.03
	85.18"(2164mm)	84"(2134mm)	GSX -4284-L	■ ■ ■ ■ ■	1676.08	1862.77	2504.17	2690.86
	91.18"(2316mm)	90"(2286mm)	GSX -4290-L	■ ■ ■ ■ ■	1722.07	1922.09	2604.66	2804.68
	97.18"(2468mm)	96"(2438mm)	GSX -4296-L	■ ■ ■ ■ ■	1768.06	1981.42	2705.15	2918.51
103.18"(2621mm)	102"(2591mm)	GSX -42A2-L	■ ■ ■ ■ ■	1814.05	2040.74	2805.64	3032.33	
109.18"(2773mm)	108"(2743mm)	GSX -42A8-L	■ ■ ■ ■ ■	1860.04	2100.07	2906.13	3146.16	
115.18"(2926mm)	114"(2896mm)	GSX -42B4-L	■ ■ ■ ■ ■	1906.03	2159.39	3006.62	3259.98	
50"(1270mm)	19.18"(487mm)	18"(457mm)	GSX -5018-L	■ ■ ■ ■ ■	\$ 943.88	\$ 991.50	\$ 1172.47	\$ 1220.09
	25.18"(640mm)	24"(610mm)	GSX -5024-L	■ ■ ■ ■ ■	998.63	1062.13	1281.72	1345.22
	31.18"(792mm)	30"(762mm)	GSX -5030-L	■ ■ ■ ■ ■	1053.38	1132.75	1390.97	1470.34
	37.18"(944mm)	36"(914mm)	GSX -5036-L	■ ■ ■ ■ ■	1263.57	1358.82	1655.66	1750.91
	43.18"(1097mm)	42"(1067mm)	GSX -5042-L	■ ■ ■ ■ ■	1415.47	1526.60	1862.06	1973.19
	49.18"(1249mm)	48"(1219mm)	GSX -5048-L	■ ■ ■ ■ ■	1470.22	1597.22	1971.31	2098.31
	55.18"(1402mm)	54"(1372mm)	GSX -5054-L	■ ■ ■ ■ ■	1524.97	1667.84	2080.56	2223.43
	61.18"(1554mm)	60"(1524mm)	GSX -5060-L	■ ■ ■ ■ ■	1579.72	1738.47	2189.81	2348.56
	67.18"(1706mm)	66"(1676mm)	GSX -5066-L	■ ■ ■ ■ ■	1634.47	1809.09	2299.06	2473.68
	73.18"(1859mm)	72"(1829mm)	GSX -5072-L	■ ■ ■ ■ ■	1689.22	1879.72	2408.31	2598.81
	79.18"(2011mm)	78"(1981mm)	GSX -5078-L	■ ■ ■ ■ ■	1743.97	1950.35	2517.56	2723.94
	85.18"(2164mm)	84"(2134mm)	GSX -5084-L	■ ■ ■ ■ ■	1798.72	2020.97	2626.81	2849.06
	91.18"(2316mm)	90"(2286mm)	GSX -5090-L	■ ■ ■ ■ ■	1853.47	2091.59	2736.06	2974.18
	97.18"(2468mm)	96"(2438mm)	GSX -5096-L	■ ■ ■ ■ ■	1908.22	2162.22	2845.31	3099.31
103.18"(2621mm)	102"(2591mm)	GSX -50A2-L	■ ■ ■ ■ ■	1962.97	2232.84	2954.56	3224.43	
109.18"(2773mm)	108"(2743mm)	GSX -50A8-L	■ ■ ■ ■ ■	2017.72	2303.47	3063.81	3349.56	
115.18"(2926mm)	114"(2896mm)	GSX -50B4-L	■ ■ ■ ■ ■	2072.47	2374.10	3173.06	3474.69	

Panel to Panel Face Attachment

D (Two-Sided Half Left and Half Right Mount)

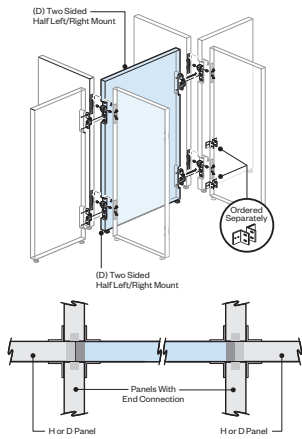

Feature

- Face connections add 1.18”(30mm) to width.

Specification Tips

- Designed to connect to other panels on the face and/or end.
- The half face connection requires another Two-Sided Half Mount panel type (D or H) for this application. Panel heights must match, widths may be different.
- Panel has four half face (male) connections, two each side.
- **Not for use with Compose or Compose Gallery panels.**
- For attachment to other panels:
 - Separately specify one Tie Plate (ZBBP-0000-PN) to secure end-to-end panels in 180° conditions. Required at each end-to-end connection.
 - Separately specify Panel Attachment Brackets (ZUBW-0000-PN or ZUBW-0000-CN) for each 90° panel to panel condition. Each inside corner requires two Panel Attachment Brackets.
- Wood grain laminate can be vertical or horizontal. See illustrations below for limitations. Specify appropriate laminate surface code.

To Order, Specify:

1) Product number, including:

1 Half Face Connection Height (Male)

- B** 34”(864mm)H Connection
- C** 42”(1067mm)H Connection
- D** 50”(1270mm)H Connection

2 Glass Options

- N** No Glass (Finished Top)
- G** Glass Ready

2) HPL surface color.

3) Edgeband color.

Horizontal Wood Grain

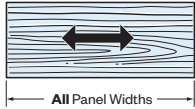

Vertical Wood Grain

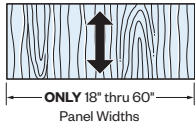

GSDB
Class BC

Panel to Panel Face Attachment

D (Two-Sided Half Left and Half Right Mount)

Nominal Height	Actual Width	Nominal Width	Number		No Glass HPL		Glass Ready HPL	
			①	②	A	B	A	B
34"(864mm)	49.18"(1249mm)	48"(1219mm)	GSDB-3448-LNN	N	2161.73	2248.09	2662.82	2749.18
	55.18"(1402mm)	54"(1372mm)	GSDB-3454-LNN	N	2198.96	2296.11	2754.55	2851.70
	61.18"(1554mm)	60"(1524mm)	GSDB-3460-LNN	N	2236.19	2344.14	2846.28	2954.23
	67.18"(1706mm)	66"(1676mm)	GSDB-3466-LNN	N	2273.42	2392.17	2938.01	3056.76
	73.18"(1859mm)	72"(1829mm)	GSDB-3472-LNN	N	2310.65	2440.19	3029.74	3159.28
	79.18"(2011mm)	78"(1981mm)	GSDB-3478-LNN	N	2347.88	2488.21	3121.47	3261.80
	85.18"(2164mm)	84"(2134mm)	GSDB-3484-LNN	N	2385.11	2536.24	3213.20	3364.33
	91.18"(2316mm)	90"(2286mm)	GSDB-3490-LNN	N	2422.34	2584.26	3304.93	3466.85
	97.18"(2468mm)	96"(2438mm)	GSDB-3496-LNN	N	2459.57	2632.29	3396.66	3569.38
	103.18"(2621mm)	102"(2591mm)	GSDB-34A2-LNN	N	2496.80	2680.32	3488.39	3671.91
	109.18"(2773mm)	108"(2743mm)	GSDB-34A8-LNN	N	2534.03	2728.34	3580.12	3774.43
	115.18"(2926mm)	114"(2896mm)	GSDB-34B4-LNN	N	2571.26	2776.36	3671.85	3876.95
	42"(1067mm)	49.18"(1249mm)	48"(1219mm)	GSD -4248-LNN	N	2231.81	2338.49	2732.90
55.18"(1402mm)		54"(1372mm)	GSD -4254-LNN	N	2277.80	2397.81	2833.39	2953.40
61.18"(1554mm)		60"(1524mm)	GSD -4260-LNN	N	2323.79	2457.14	2933.88	3067.23
67.18"(1706mm)		66"(1676mm)	GSD -4266-LNN	N	2369.78	2516.46	3034.37	3181.05
73.18"(1859mm)		72"(1829mm)	GSD -4272-LNN	N	2415.77	2575.79	3134.86	3294.88
79.18"(2011mm)		78"(1981mm)	GSD -4278-LNN	N	2461.76	2635.11	3235.35	3408.70
85.18"(2164mm)		84"(2134mm)	GSD -4284-LNN	N	2507.75	2694.44	3335.84	3522.53
91.18"(2316mm)		90"(2286mm)	GSD -4290-LNN	N	2553.74	2753.76	3436.33	3636.35
97.18"(2468mm)		96"(2438mm)	GSD -4296-LNN	N	2599.73	2813.09	3536.82	3750.18
103.18"(2621mm)		102"(2591mm)	GSD -42A2-LNN	N	2645.72	2872.41	3637.31	3864.00
109.18"(2773mm)		108"(2743mm)	GSD -42A8-LNN	N	2691.71	2931.74	3737.80	3977.83
115.18"(2926mm)		114"(2896mm)	GSD -42B4-LNN	N	2737.70	2991.06	3838.29	4091.65
50"(1270mm)		49.18"(1249mm)	48"(1219mm)	GSD -5048-LNN	N	2301.89	2428.89	2802.98
	55.18"(1402mm)	54"(1372mm)	GSD -5054-LNN	N	2356.64	2499.51	2912.23	3055.10
	61.18"(1554mm)	60"(1524mm)	GSD -5060-LNN	N	2411.39	2570.14	3021.48	3180.23
	67.18"(1706mm)	66"(1676mm)	GSD -5066-LNN	N	2466.14	2640.76	3130.73	3305.35
	73.18"(1859mm)	72"(1829mm)	GSD -5072-LNN	N	2520.89	2711.39	3239.98	3430.48
	79.18"(2011mm)	78"(1981mm)	GSD -5078-LNN	N	2575.64	2782.02	3349.23	3555.61
	85.18"(2164mm)	84"(2134mm)	GSD -5084-LNN	N	2630.39	2852.64	3458.48	3680.73
	91.18"(2316mm)	90"(2286mm)	GSD -5090-LNN	N	2685.14	2923.26	3567.73	3805.85
	97.18"(2468mm)	96"(2438mm)	GSD -5096-LNN	N	2739.89	2993.89	3676.98	3930.98
	103.18"(2621mm)	102"(2591mm)	GSD -50A2-LNN	N	2794.64	3064.51	3786.23	4056.10
	109.18"(2773mm)	108"(2743mm)	GSD -50A8-LNN	N	2849.39	3135.14	3895.48	4181.23
	115.18"(2926mm)	114"(2896mm)	GSD -50B4-LNN	N	2904.14	3205.77	4004.73	4306.36

Panel to Panel End Attachment I (90° Face Connection)

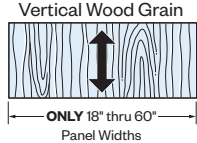
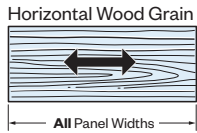
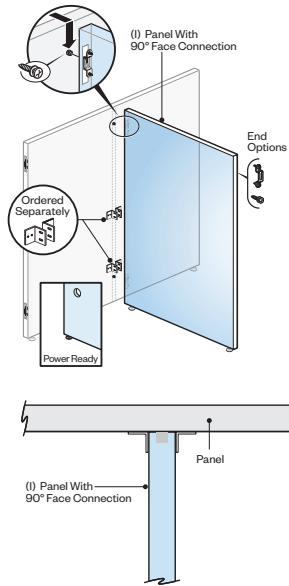

GSIN
Class BC

Features

- Does not include a face mount width modifier.
- When specified, connection ends are (female) connections.
- Spine adjacent pass-through at power shroud height. See product details for exact locations and dimensions for each panel configuration.

Specification Tips

- Connection End is designed to attach to other panels perpendicular to the face.
- Panel has end connections only.
- **Not for use with Compose or Compose Gallery panels.**
- For attachment to other panels:
 - Separately specify one Tie Plate (ZBBP-0000-PN) to secure end-to-end panels in 180° conditions. Required at each end-to-end connection.
 - Separately specify Panel Attachment Brackets (ZUBW-0000-PN or ZUBW-0000-CN) for each 90° panel to panel condition. Each inside corner requires two Panel Attachment Brackets.
- Wood grain laminate can be vertical or horizontal. See illustrations below for limitations. Specify appropriate laminate surface code.

To Order, Specify:

1) Product number, including:

1 Connection End (Female)

- B** 34"(864mm)H Connection
- C** 42"(1067mm)H Connection
- D** 50"(1270mm)H Connection

2 Other End (Finished End or Connection End) (Female)

- N** No Connection (Finished End)
- B** 34"(864mm)H Connection
- C** 42"(1067mm)H Connection
- D** 50"(1270mm)H Connection

3 Glass Options

- N** No Glass (Finished Top)
- G** Glass Ready

4 Power Pass-through (Return Applications ONLY)

- N** No Power Ready
- P** Power Ready

2) HPL surface color.

3) Edgeband color.

Panel to Panel End Attachment I (90° Face Connection)

Nominal Height	Nominal Width	Number	①②③④	No Glass		Glass Ready	
				HPL A	HPL B	HPL A	HPL B
34"(864mm)	18"(457mm)	GSIN-3418-L	■ ■ ■ ■	\$ 633.57	\$665.95	\$862.16	\$894.54
	24"(610mm)	GSIN-3424-L	■ ■ ■ ■	670.80	713.98	953.89	997.07
	30"(762mm)	GSIN-3430-L	■ ■ ■ ■	708.03	762.01	1045.62	1099.60
	36"(914mm)	GSIN-3436-L	■ ■ ■ ■	900.70	965.47	1292.79	1357.56
	42"(1067mm)	GSIN-3442-L	■ ■ ■ ■	1035.08	1110.64	1481.67	1557.23
	48"(1219mm)	GSIN-3448-L	■ ■ ■ ■	1072.31	1158.67	1573.40	1659.76
	54"(1372mm)	GSIN-3454-L	■ ■ ■ ■	1109.54	1206.69	1665.13	1762.28
	60"(1524mm)	GSIN-3460-L	■ ■ ■ ■	1146.77	1254.72	1756.86	1864.81
	66"(1676mm)	GSIN-3466-L	■ ■ ■ ■	1184.00	1302.75	1848.59	1967.34
	72"(1829mm)	GSIN-3472-L	■ ■ ■ ■	1221.23	1350.77	1940.32	2069.86
	78"(1981mm)	GSIN-3478-L	■ ■ ■ ■	1258.46	1398.79	2032.05	2172.38
	84"(2134mm)	GSIN-3484-L	■ ■ ■ ■	1295.69	1446.82	2123.78	2274.91
	90"(2286mm)	GSIN-3490-L	■ ■ ■ ■	1332.92	1494.84	2215.51	2377.43
	96"(2438mm)	GSIN-3496-L	■ ■ ■ ■	1370.15	1542.87	2307.24	2479.96
42"(1067mm)	18"(457mm)	GSIN-4218-L	■ ■ ■ ■	\$ 659.85	\$ 699.85	\$ 888.44	\$ 928.44
	24"(610mm)	GSIN-4224-L	■ ■ ■ ■	705.84	759.18	988.93	1042.27
	30"(762mm)	GSIN-4230-L	■ ■ ■ ■	751.83	818.50	1089.42	1156.09
	36"(914mm)	GSIN-4236-L	■ ■ ■ ■	953.26	1033.27	1345.35	1425.36
	42"(1067mm)	GSIN-4242-L	■ ■ ■ ■	1096.40	1189.74	1542.99	1636.33
	48"(1219mm)	GSIN-4248-L	■ ■ ■ ■	1142.39	1249.07	1643.48	1750.16
	54"(1372mm)	GSIN-4254-L	■ ■ ■ ■	1188.38	1308.39	1743.97	1863.98
	60"(1524mm)	GSIN-4260-L	■ ■ ■ ■	1234.37	1367.72	1844.46	1977.81
	66"(1676mm)	GSIN-4266-L	■ ■ ■ ■	1280.36	1427.04	1944.95	2091.63
	72"(1829mm)	GSIN-4272-L	■ ■ ■ ■	1326.35	1486.37	2045.44	2205.46
	78"(1981mm)	GSIN-4278-L	■ ■ ■ ■	1372.34	1545.69	2145.93	2319.28
	84"(2134mm)	GSIN-4284-L	■ ■ ■ ■	1418.33	1605.02	2246.42	2433.11
	90"(2286mm)	GSIN-4290-L	■ ■ ■ ■	1464.32	1664.34	2346.91	2546.93
	96"(2438mm)	GSIN-4296-L	■ ■ ■ ■	1510.31	1723.67	2447.40	2660.76
50"(1270mm)	18"(457mm)	GSIN-5018-L	■ ■ ■ ■	\$ 686.13	\$ 733.75	\$ 914.72	\$ 962.34
	24"(610mm)	GSIN-5024-L	■ ■ ■ ■	740.88	804.38	1023.97	1087.47
	30"(762mm)	GSIN-5030-L	■ ■ ■ ■	795.63	875.00	1133.22	1212.59
	36"(914mm)	GSIN-5036-L	■ ■ ■ ■	1005.82	1101.07	1397.91	1493.16
	42"(1067mm)	GSIN-5042-L	■ ■ ■ ■	1157.72	1268.85	1604.31	1715.44
	48"(1219mm)	GSIN-5048-L	■ ■ ■ ■	1212.47	1339.47	1713.56	1840.56
	54"(1372mm)	GSIN-5054-L	■ ■ ■ ■	1267.22	1410.09	1822.81	1965.68
	60"(1524mm)	GSIN-5060-L	■ ■ ■ ■	1321.97	1480.72	1932.06	2090.81
	66"(1676mm)	GSIN-5066-L	■ ■ ■ ■	1376.72	1551.34	2041.31	2215.93
	72"(1829mm)	GSIN-5072-L	■ ■ ■ ■	1431.47	1621.97	2150.56	2341.06
	78"(1981mm)	GSIN-5078-L	■ ■ ■ ■	1486.22	1692.60	2259.81	2466.19
	84"(2134mm)	GSIN-5084-L	■ ■ ■ ■	1540.97	1763.22	2369.06	2591.31
	90"(2286mm)	GSIN-5090-L	■ ■ ■ ■	1595.72	1833.84	2478.31	2716.43
	96"(2438mm)	GSIN-5096-L	■ ■ ■ ■	1650.47	1904.47	2587.56	2841.56
102"(2591mm)	102"(2591mm)	GSIN-50A2-L	■ ■ ■ ■	1705.22	1975.09	2696.81	2966.68
	108"(2743mm)	GSIN-50A8-L	■ ■ ■ ■	1759.97	2045.72	2806.06	3091.81
	114"(2896mm)	GSIN-50B4-L	■ ■ ■ ■	1814.72	2116.35	2915.31	3216.94
	120"(3048mm)	GSIN-50C0-L	■ ■ ■ ■	1869.47	2186.97	3024.56	3342.06

Panel to Panel End Attachment

S (Straight In-Line Add-On)

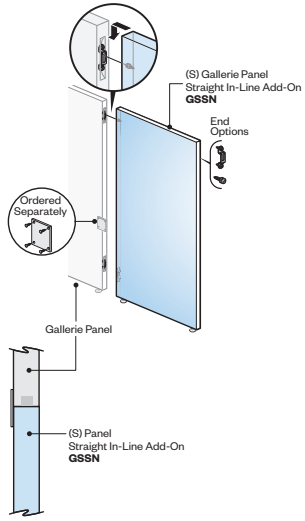

Horizontal Wood Grain



Vertical Wood Grain

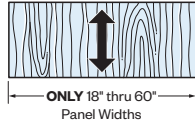

GSSN
Class BC

Features

- Does not include a face mount width modifier.
- Male connection at the connection end, optional (female) connection at the other end.

Specifications Tips

- Connection End is designed to attach to other panels end-to-end in straight in-line conditions.
- Panel has end connections only. Connection end is male to connect to end of another panel.
- **Not for use with Compose or Compose Gallery panels.**
- For attachment to other panels:
 - Separately specify one Tie Plate (ZBBP-0000-PN) to secure end-to-end panels in 180° conditions. Required at each end-to-end connection.
 - Separately specify Panel Attachment Brackets (ZUBW-0000-PN or ZUBW-0000-CN) for each 90° panel to panel condition. Each inside corner requires two Panel Attachment Brackets.
- Wood grain laminate can be vertical or horizontal. See illustrations below for limitations. Specify appropriate laminate surface code.

To Order, Specify:

1) Product number, including:

1 Connection End (Male)

- B** 34"(864mm)H Connection
- C** 42"(1067mm)H Connection
- D** 50"(1270mm)H Connection

2 Other End (Finished End or Connection End) (Female)

- N** No Connection (Finished End)
- B** 34"(864mm)H Connection
- C** 42"(1067mm)H Connection
- D** 50"(1270mm)H Connection

3 Glass Options

- N** No Glass (Finished Top)
- G** Glass Ready

2) HPL surface color.

3) Edgeband color.

Panel to Panel End Attachment

S (Straight In-Line Add-On)

Nominal Height	Nominal Width	Number ①②③	No Glass		Glass Ready	
			HPL A	HPL B	HPL A	HPL B
34"(864mm)	18"(457mm)	GSSN-3418-L ■■■ N	\$ 633.57	\$665.95	\$862.16	\$894.54
	24"(610mm)	GSSN-3424-L ■■■ N	670.80	713.98	953.89	997.07
	30"(762mm)	GSSN-3430-L ■■■ N	708.03	762.01	1045.62	1099.60
	36"(914mm)	GSSN-3436-L ■■■ N	900.70	965.47	1292.79	1357.56
	42"(1067mm)	GSSN-3442-L ■■■ N	1035.08	1110.64	1481.67	1557.23
	48"(1219mm)	GSSN-3448-L ■■■ N	1072.31	1158.67	1573.40	1659.76
	54"(1372mm)	GSSN-3454-L ■■■ N	1109.54	1206.69	1665.13	1762.28
	60"(1524mm)	GSSN-3460-L ■■■ N	1146.77	1254.72	1756.86	1864.81
	66"(1676mm)	GSSN-3466-L ■■■ N	1184.00	1302.75	1848.59	1967.34
	72"(1829mm)	GSSN-3472-L ■■■ N	1221.23	1350.77	1940.32	2069.86
	78"(1981mm)	GSSN-3478-L ■■■ N	1258.46	1398.79	2032.05	2172.38
	84"(2134mm)	GSSN-3484-L ■■■ N	1295.69	1446.82	2123.78	2274.91
	90"(2286mm)	GSSN-3490-L ■■■ N	1332.92	1494.84	2215.51	2377.43
	96"(2438mm)	GSSN-3496-L ■■■ N	1370.15	1542.87	2307.24	2479.96
	102"(2591mm)	GSSN-34A2-L ■■■ N	1407.38	1590.90	2398.97	2582.49
108"(2743mm)	GSSN-34A8-L ■■■ N	1444.61	1638.92	2490.70	2685.01	
114"(2896mm)	GSSN-34B4-L ■■■ N	1481.84	1686.94	2582.43	2787.53	
120"(3048mm)	GSSN-34C0-L ■■■ N	1519.07	1734.97	2674.16	2890.06	
42"(1067mm)	18"(457mm)	GSSN-4218-L ■■■ N	\$ 659.85	\$ 699.85	\$ 888.44	\$ 928.44
	24"(610mm)	GSSN-4224-L ■■■ N	705.84	759.18	988.93	1042.27
	30"(762mm)	GSSN-4230-L ■■■ N	751.83	818.50	1089.42	1156.09
	36"(914mm)	GSSN-4236-L ■■■ N	953.26	1033.27	1345.35	1425.36
	42"(1067mm)	GSSN-4242-L ■■■ N	1096.40	1189.74	1542.99	1636.33
	48"(1219mm)	GSSN-4248-L ■■■ N	1142.39	1249.07	1643.48	1750.16
	54"(1372mm)	GSSN-4254-L ■■■ N	1188.38	1308.39	1743.97	1863.98
	60"(1524mm)	GSSN-4260-L ■■■ N	1234.37	1367.72	1844.46	1977.81
	66"(1676mm)	GSSN-4266-L ■■■ N	1280.36	1427.04	1944.95	2091.63
	72"(1829mm)	GSSN-4272-L ■■■ N	1326.35	1486.37	2045.44	2205.46
	78"(1981mm)	GSSN-4278-L ■■■ N	1372.34	1545.69	2145.93	2319.28
	84"(2134mm)	GSSN-4284-L ■■■ N	1418.33	1605.02	2246.42	2433.11
	90"(2286mm)	GSSN-4290-L ■■■ N	1464.32	1664.34	2346.91	2546.93
	96"(2438mm)	GSSN-4296-L ■■■ N	1510.31	1723.67	2447.40	2660.76
	102"(2591mm)	GSSN-42A2-L ■■■ N	1556.30	1782.99	2547.89	2774.58
108"(2743mm)	GSSN-42A8-L ■■■ N	1602.29	1842.32	2648.38	2888.41	
114"(2896mm)	GSSN-42B4-L ■■■ N	1648.28	1901.64	2748.87	3002.23	
120"(3048mm)	GSSN-42C0-L ■■■ N	1694.27	1960.97	2849.36	3116.06	
50"(1270mm)	18"(457mm)	GSSN-5018-L ■■■ N	\$ 686.13	\$ 733.75	\$ 914.72	\$ 962.34
	24"(610mm)	GSSN-5024-L ■■■ N	740.88	804.38	1023.97	1087.47
	30"(762mm)	GSSN-5030-L ■■■ N	795.63	875.00	1133.22	1212.59
	36"(914mm)	GSSN-5036-L ■■■ N	1005.82	1101.07	1397.91	1493.16
	42"(1067mm)	GSSN-5042-L ■■■ N	1157.72	1268.85	1604.31	1715.44
	48"(1219mm)	GSSN-5048-L ■■■ N	1212.47	1339.47	1713.56	1840.56
	54"(1372mm)	GSSN-5054-L ■■■ N	1267.22	1410.09	1822.81	1965.68
	60"(1524mm)	GSSN-5060-L ■■■ N	1321.97	1480.72	1932.06	2090.81
	66"(1676mm)	GSSN-5066-L ■■■ N	1376.72	1551.34	2041.31	2215.93
	72"(1829mm)	GSSN-5072-L ■■■ N	1431.47	1621.97	2150.56	2341.06
	78"(1981mm)	GSSN-5078-L ■■■ N	1486.22	1692.60	2259.81	2466.19
	84"(2134mm)	GSSN-5084-L ■■■ N	1540.97	1763.22	2369.06	2591.31
	90"(2286mm)	GSSN-5090-L ■■■ N	1595.72	1833.84	2478.31	2716.43
	96"(2438mm)	GSSN-5096-L ■■■ N	1650.47	1904.47	2587.56	2841.56
	102"(2591mm)	GSSN-50A2-L ■■■ N	1705.22	1975.09	2696.81	2966.68
108"(2743mm)	GSSN-50A8-L ■■■ N	1759.97	2045.72	2806.06	3091.81	
114"(2896mm)	GSSN-50B4-L ■■■ N	1814.72	2116.35	2915.31	3216.94	
120"(3048mm)	GSSN-50C0-L ■■■ N	1869.47	2186.97	3024.56	3342.06	

Panel to Panel End Attachment

M (End Connector)

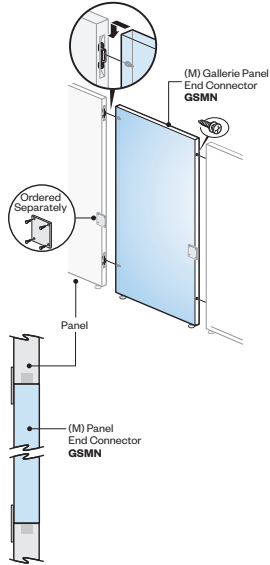

Features

- No face connection.
- Male connections at each end.

Specifications Tips

- Connection End is designed to attach to two other panels end-to-end in straight in-line conditions.
- Requires two adjacent panels to have (female) end connections for attachment.
- Panel has two end (male) connections.
- **Not for use with Compose or Compose Gallery panels.**
- For attachment to other panels:
 - Separately specify one Tie Plate (ZBBP-0000-PN) to secure end-to-end panels in 180° conditions. Required at each end-to-end connection.
 - Separately specify Panel Attachment Brackets (ZUBW-0000-PN or ZUBW-0000-CN) for each 90° panel to panel condition. Each inside corner requires two Panel Attachment Brackets.
- Wood grain laminate can be vertical or horizontal. See illustrations below for limitations. Specify appropriate laminate surface code.

To Order, Specify:

1) Product number, including:

1 Connection End (Male)

- B** 34"(864mm)H Connection
- C** 42"(1067mm)H Connection
- D** 50"(1270mm)H Connection

2 Other End (or Connection End) (Male)

- B** 34"(864mm)H Connection
- C** 42"(1067mm)H Connection
- D** 50"(1270mm)H Connection

3 Glass Options

- N** No Glass (Finished Top)
- G** Glass Ready

- 2) HPL surface color.
- 3) Edgeband color.

Horizontal Wood Grain



Vertical Wood Grain

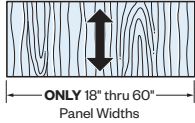

GSMN
Class BC

Panel to Panel End Attachment

M (End Connector)

Nominal Height	Nominal Width	Number ①②③	No Glass		Glass Ready	
			HPL A	HPL B	HPL A	HPL B
34"(864mm)	18"(457mm)	GSMN-3418-L ■■■ N	\$ 633.57	\$665.95	\$862.16	\$894.54
	24"(610mm)	GSMN-3424-L ■■■ N	670.80	713.98	953.89	997.07
	30"(762mm)	GSMN-3430-L ■■■ N	708.03	762.01	1045.62	1099.60
	36"(914mm)	GSMN-3436-L ■■■ N	900.70	965.47	1292.79	1357.56
	42"(1067mm)	GSMN-3442-L ■■■ N	1035.08	1110.64	1481.67	1557.23
	48"(1219mm)	GSMN-3448-L ■■■ N	1072.31	1158.67	1573.40	1659.76
	54"(1372mm)	GSMN-3454-L ■■■ N	1109.54	1206.69	1665.13	1762.28
	60"(1524mm)	GSMN-3460-L ■■■ N	1146.77	1254.72	1756.86	1864.81
	66"(1676mm)	GSMN-3466-L ■■■ N	1184.00	1302.75	1848.59	1967.34
	72"(1829mm)	GSMN-3472-L ■■■ N	1221.23	1350.77	1940.32	2069.86
	78"(1981mm)	GSMN-3478-L ■■■ N	1258.46	1398.79	2032.05	2172.38
	84"(2134mm)	GSMN-3484-L ■■■ N	1295.69	1446.82	2123.78	2274.91
	90"(2286mm)	GSMN-3490-L ■■■ N	1332.92	1494.84	2215.51	2377.43
	96"(2438mm)	GSMN-3496-L ■■■ N	1370.15	1542.87	2307.24	2479.96
	102"(2591mm)	GSMN-34A2-L ■■■ N	1407.38	1590.90	2398.97	2582.49
	108"(2743mm)	GSMN-34A8-L ■■■ N	1444.61	1638.92	2490.70	2685.01
114"(2896mm)	GSMN-34B4-L ■■■ N	1481.84	1686.94	2582.43	2787.53	
120"(3048mm)	GSMN-34C0-L ■■■ N	1519.07	1734.97	2674.16	2890.06	
42"(1067mm)	18"(457mm)	GSMN-4218-L ■■■ N	\$ 659.85	\$ 699.85	\$ 888.44	\$ 928.44
	24"(610mm)	GSMN-4224-L ■■■ N	705.84	759.18	988.93	1042.27
	30"(762mm)	GSMN-4230-L ■■■ N	751.83	818.50	1089.42	1156.09
	36"(914mm)	GSMN-4236-L ■■■ N	953.26	1033.27	1345.35	1425.36
	42"(1067mm)	GSMN-4242-L ■■■ N	1096.40	1189.74	1542.99	1636.33
	48"(1219mm)	GSMN-4248-L ■■■ N	1142.39	1249.07	1643.48	1750.16
	54"(1372mm)	GSMN-4254-L ■■■ N	1188.38	1308.39	1743.97	1863.98
	60"(1524mm)	GSMN-4260-L ■■■ N	1234.37	1367.72	1844.46	1977.81
	66"(1676mm)	GSMN-4266-L ■■■ N	1280.36	1427.04	1944.95	2091.63
	72"(1829mm)	GSMN-4272-L ■■■ N	1326.35	1486.37	2045.44	2205.46
	78"(1981mm)	GSMN-4278-L ■■■ N	1372.34	1545.69	2145.93	2319.28
	84"(2134mm)	GSMN-4284-L ■■■ N	1418.33	1605.02	2246.42	2433.11
	90"(2286mm)	GSMN-4290-L ■■■ N	1464.32	1664.34	2346.91	2546.93
	96"(2438mm)	GSMN-4296-L ■■■ N	1510.31	1723.67	2447.40	2660.76
	102"(2591mm)	GSMN-42A2-L ■■■ N	1556.30	1782.99	2547.89	2774.58
	108"(2743mm)	GSMN-42A8-L ■■■ N	1602.29	1842.32	2648.38	2888.41
114"(2896mm)	GSMN-42B4-L ■■■ N	1648.28	1901.64	2748.87	3002.23	
120"(3048mm)	GSMN-42C0-L ■■■ N	1694.27	1960.97	2849.36	3116.06	
50"(1270mm)	18"(457mm)	GSMN-5018-L ■■■ N	\$ 686.13	\$ 733.75	\$ 914.72	\$ 962.34
	24"(610mm)	GSMN-5024-L ■■■ N	740.88	804.38	1023.97	1087.47
	30"(762mm)	GSMN-5030-L ■■■ N	795.63	875.00	1133.22	1212.59
	36"(914mm)	GSMN-5036-L ■■■ N	1005.82	1101.07	1397.91	1493.16
	42"(1067mm)	GSMN-5042-L ■■■ N	1157.72	1268.85	1604.31	1715.44
	48"(1219mm)	GSMN-5048-L ■■■ N	1212.47	1339.47	1713.56	1840.56
	54"(1372mm)	GSMN-5054-L ■■■ N	1267.22	1410.09	1822.81	1965.68
	60"(1524mm)	GSMN-5060-L ■■■ N	1321.97	1480.72	1932.06	2090.81
	66"(1676mm)	GSMN-5066-L ■■■ N	1376.72	1551.34	2041.31	2215.93
	72"(1829mm)	GSMN-5072-L ■■■ N	1431.47	1621.97	2150.56	2341.06
	78"(1981mm)	GSMN-5078-L ■■■ N	1486.22	1692.60	2259.81	2466.19
	84"(2134mm)	GSMN-5084-L ■■■ N	1540.97	1763.22	2369.06	2591.31
	90"(2286mm)	GSMN-5090-L ■■■ N	1595.72	1833.84	2478.31	2716.43
	96"(2438mm)	GSMN-5096-L ■■■ N	1650.47	1904.47	2587.56	2841.56
	102"(2591mm)	GSMN-50A2-L ■■■ N	1705.22	1975.09	2696.81	2966.68
	108"(2743mm)	GSMN-50A8-L ■■■ N	1759.97	2045.72	2806.06	3091.81
114"(2896mm)	GSMN-50B4-L ■■■ N	1814.72	2116.35	2915.31	3216.94	
120"(3048mm)	GSMN-50C0-L ■■■ N	1869.47	2186.97	3024.56	3342.06	

Worksurface Support

Worksurface Support Panel

Architectural Wall, Compose Gallery Panel or Gallerie

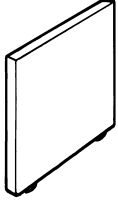

Edgeband



Knife

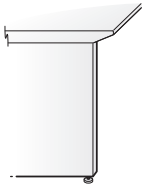

ZYFS
Class CA

Features

- Includes support panel with glides.
- Field installs on architectural wall, Gallerie, or Compose Gallery panel and attaches off modularly under one or two worksurfaces.
- Provides full support for equal depth worksurfaces.
- Recommended in heavy loading conditions.
- High-pressure laminate (HPL) with 1mm edgeband.
- Adjustable glides provide a maximum of 2.5"(64mm) of height adjustment.

Specification Tips

- Specify worksurface support panel to match worksurface depth and edge option.
- Non-handed design may be installed in left-hand, right-hand or shared configuration.
- Anti-Dislodgement Bracket is not required in wall, Gallerie or Compose Gallery panel applications.
- Requires separately specified panel-attachment brackets (ZUBW-0000-_N).
 - End-of-Run applications require a total of four (4) brackets: two (2) brackets mounted to the panel or wall and two (2) brackets mounted to the worksurface.
 - Intermediate shared conditions require a total of eight (8) brackets; per side: two (2) brackets mounted to the panel or wall and two (2) brackets mounted to the worksurface.

To Order, Specify:

1) Product number, including:

1 Edge Options:

Laminate:

- J Edgeband
- F Knife

2) HPL color.

3) Edge trim color.

Height	Thickness	Depth	Number ①	HPL	
				A	B
27.875"(708mm)	1.18"(30mm)	12"(305mm)	ZYFS-1200-LNE 	\$ 512.46	\$ 555.37
		18"(457mm)	ZYFS-1800-LNE 	555.36	595.09
		24"(610mm)	ZYFS-2400-LNE 	598.26	634.81
		30"(762mm)	ZYFS-3000-LNE 	641.16	674.53

Panel Accessories

Panel Attachment Bracket

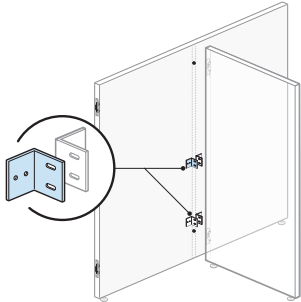

ZUBW-0000-PN

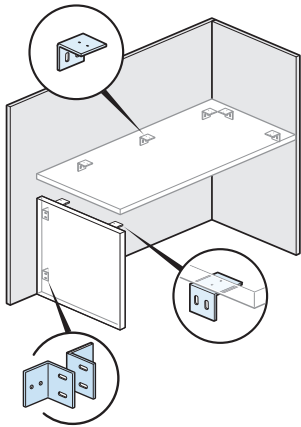

ZUBW-0000-CN
Class BCX

Feature

- Includes one steel non-handed bracket and hardware.

Specification Tips

- Designed to be used to connect:
 - Panel to Panel or Panel to Structural Wall:
 - Use two brackets for each 90° connection
 - Worksurface to Panel or Structural Wall
 - 24"(610mm)-42"(1067mm)W requires two brackets
 - 48"(1219mm)-78"(1981mm)W requires three brackets
 - 84"(2134mm)-120"(3048mm)W requires four brackets
- Screws or anchors for attachment to structural wall are field supplied.
- Must be properly anchored to a structural wall.
- Refer to the Specification Guide for planning and installation details.

To Order, Specify:

- 1) Product number.
- 2) Trim color (if applicable).

Description	Depth	Width	Number	Price	Trim	
					A	B
Wall Mount Bracket (Black)	2"(51mm)	2"(51mm)	ZUBW-0000-PN	\$43.91	N/A	N/A
Wall Mount Bracket (trim color required)	2"(51mm)	2"(51mm)	ZUBW-0000-CN	N/A	\$50.91	\$59.80

Tie Plate

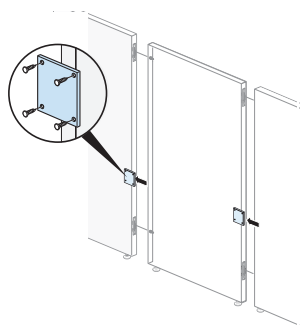

ZBBP-0000-PN
Class IN

Features

- Includes tie plate and attachment hardware.
- Tie plate is used to connect Gallerie Panels in-line.

Specification Tip

- Refer to Specification Guide for planning information.

To Order, Specify:

- 1) Product number.
- 2) Trim color (if applicable).

Description	Depth	Width	Number	Price	Trim	
					A	B
Tie Plate (Black)	3.5"(89mm)	3"(76mm)	ZBBP-0000-PN	\$30.62	N/A	N/A
Tie Plate (trim color required)			ZBBP-0000-CN		\$37.04	\$42.39

Panel Accessories

Glass Topper

Panel Mounting

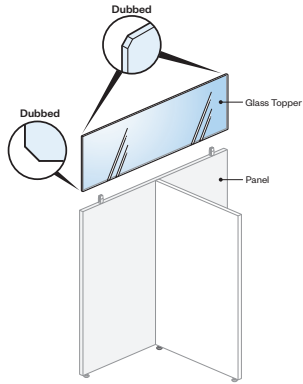

VZSG
Class BC

Feature

- Includes one 0.25”(6mm) thick insert with beveled edges and dubbed corners.

Specification Tips

- For use with Gallerie and Compose Gallery panels that use the “N - No Glass” option. Not for use with panels specified as “G - Glass Ready.”
- Requires the Gallerie Topper Holder Kit.
- Glass Topper may:
 - Span multiple panels
 - Be smaller than the panel
 - Be mounted off-modular
- Custom glass inserts may be field supplied:
 - Thickness: 0.236”(6mm)
 - Type: Safety glass required; tempered glass recommended

To Order, Specify:

1) Product number, including:

1 Width Modifier Options (see chart below)

- S** +0”(0mm)
- G** +1.18”(30mm) (add **\$6.78** list)
- 1** +0.59”(15mm) (add **\$2.74** list)
- 3** +1.77”(45mm) (add **\$8.21** list)
- 4** +2.36”(60mm) (add **\$10.94** list)

2) Insert color.

- 1C = Clear glass
- E21 = Satin finish

For This Face Connection Type	And This Configuration	Then Choose This Width Modifier	
Gallerie	L, R, C, D, P, X, T	G	1.18”(30mm) Additional Width
	W, E, H	1	0.59”(15mm) Additional Width
	K, J	3	1.77”(45mm) Additional Width
	U	4	2.36”(60mm) Additional Width
N Finished Face	I, S, M	S	0.00”(0mm) Additional Width

Panel Accessories

Glass Topper

Nominal Height	Nominal Width	Number ①	Clear Glass (1C)	Satin Etch (E21)
8"(203mm)	18"(457mm)	VZSG-0818-1 4	\$ 388.15	\$ 407.83
	24"(610mm)	VZSG-0824-1 4	422.56	467.79
	30"(762mm)	VZSG-0830-1 4	456.97	527.75
	36"(914mm)	VZSG-0836-1 4	491.38	587.71
	42"(1067mm)	VZSG-0842-1 4	525.79	647.67
	48"(1219mm)	VZSG-0848-1 4	560.20	707.63
	54"(1372mm)	VZSG-0854-1 4	594.61	767.59
	60"(1524mm)	VZSG-0860-1 4	629.02	827.55
	66"(1676mm)	VZSG-0866-1 4	663.43	887.51
	72"(1829mm)	VZSG-0872-1 4	904.49	1154.12
	78"(1981mm)	VZSG-0878-1 4	1016.07	1291.25
	84"(2134mm)	VZSG-0884-1 4	1050.48	1351.21
	90"(2286mm)	VZSG-0890-1 4	1084.89	1411.17
	96"(2438mm)	VZSG-0896-1 4	1119.30	1471.13
12"(305mm)	102"(2591mm)	VZSG-08A2-1 4	1153.71	1531.09
	108"(2743mm)	VZSG-08A8-1 4	1188.12	1591.05
	114"(2896mm)	VZSG-08B4-1 4	1222.53	1651.01
	120"(3048mm)	VZSG-08C0-1 4	1256.94	1710.97
	18"(457mm)	VZSG-1218-1 4	\$ 428.64	\$ 487.68
	24"(610mm)	VZSG-1224-1 4	463.05	547.64
	30"(762mm)	VZSG-1230-1 4	497.46	607.60
	36"(914mm)	VZSG-1236-1 4	531.87	667.56
	42"(1067mm)	VZSG-1242-1 4	566.28	727.52
	48"(1219mm)	VZSG-1248-1 4	622.96	809.75
	54"(1372mm)	VZSG-1254-1 4	657.37	869.71
	60"(1524mm)	VZSG-1260-1 4	691.78	929.67
	66"(1676mm)	VZSG-1266-1 4	726.19	989.63
	72"(1829mm)	VZSG-1272-1 4	967.25	1256.24
16"(406mm)	78"(1981mm)	VZSG-1278-1 4	1078.83	1393.37
	84"(2134mm)	VZSG-1284-1 4	1113.24	1453.33
	90"(2286mm)	VZSG-1290-1 4	1147.65	1513.29
	96"(2438mm)	VZSG-1296-1 4	1182.06	1573.25
	102"(2591mm)	VZSG-12A2-1 4	1216.47	1633.21
	108"(2743mm)	VZSG-12A8-1 4	1250.88	1693.17
	114"(2896mm)	VZSG-12B4-1 4	1285.29	1753.13
	120"(3048mm)	VZSG-12C0-1 4	1319.70	1813.09
	18"(457mm)	VZSG-1618-1 4	\$ 469.13	\$ 567.53
	24"(610mm)	VZSG-1624-1 4	503.54	627.49
	30"(762mm)	VZSG-1630-1 4	537.95	687.45
	36"(914mm)	VZSG-1636-1 4	572.36	747.41
	42"(1067mm)	VZSG-1642-1 4	606.77	807.37
	48"(1219mm)	VZSG-1648-1 4	722.15	948.30
54"(1372mm)	VZSG-1654-1 4	756.56	1008.26	
16"(406mm)	60"(1524mm)	VZSG-1660-1 4	790.97	1068.22
	66"(1676mm)	VZSG-1666-1 4	825.38	1128.18
	72"(1829mm)	VZSG-1672-1 4	1066.44	1394.79
	78"(1981mm)	VZSG-1678-1 4	1178.02	1531.92
	84"(2134mm)	VZSG-1684-1 4	1212.43	1591.88
	90"(2286mm)	VZSG-1690-1 4	1246.84	1651.84
	96"(2438mm)	VZSG-1696-1 4	1281.25	1711.80
	102"(2591mm)	VZSG-16A2-1 4	1315.66	1771.76
	108"(2743mm)	VZSG-16A8-1 4	1350.07	1831.72
	114"(2896mm)	VZSG-16B4-1 4	1384.48	1891.68
	120"(3048mm)	VZSG-16C0-1 4	1418.89	1951.64

Panel Accessories

Topper Holder Kit

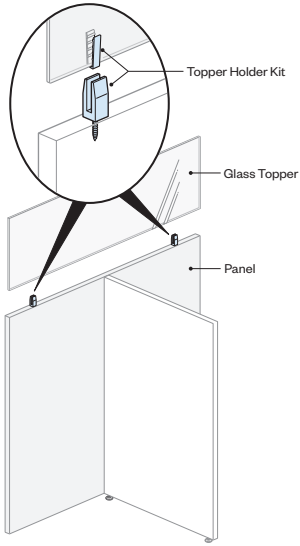

VZST
Class BC

Features

- Includes brackets and attachment hardware for attaching one piece of glass to the top of a Gallery Panel.
- Field assembly to Gallery Panel.

Specification Tips

- Designed for use with Gallerie and Compose Gallery panels with the “N – No Glass” option.
- Requires one Topper Holder Kit per panel.
- Glass Topper may:
 - Span multiple panels
 - Be smaller than the panel
 - Be mounted off-modular
- Glass must be specified separately or field supplied:
 - Thickness: 0.25”(6mm)
 - Type: Safety glass required; tempered glass recommended
- Not compatible with “G – Glass Ready” panel options.
- Refer to the Specification Guide for installation and application details.

To Order, Specify:

- 1) Product number.
- 2) Trim color.

Description	Quantity of Clips	Number	Trim	
			A	B
For Glass 72”(1829mm)W or less	2	VZST-2-4	\$ 171.35	\$ 176.35
For Glass greater than 72”(1829mm)W	3	VZST-3-4	237.03	242.03

Panel Accessories

Insert Glass

Panel Glass Ready Option

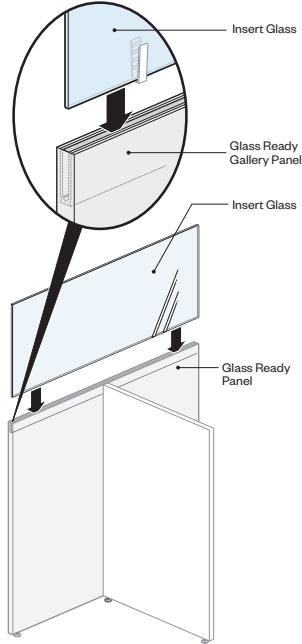

SYGG
Class BC

Feature

- Includes one 0.25”(6mm) thick insert with dubbed or radius edge corner.

Specification Tips

- For use with Gallerie and Compose Gallery panels specified with the “G - Glass Ready” option.
- Glass may
 - Span multiple panels
 - Be smaller than the panel
 - Be mounted off-modular.
- Custom glass insert may be field supplied:
 - Thickness: 0.236”(6mm)
 - Type: Safety glass required; tempered glass is recommended.
- Refer to the Application Guide for installation details.

When matching glass edge options consider the following:

	Frameless Glass Options	Topper Glass Option
	Inset Glass Options	Topper Glass Option
	VZGK	VZGT
Gallerie	R, D	D

- IF it is desirable for the glass to match the Gallerie Panel width (see chart below):

For This Face Connection Type	And This Configuration	Then Choose This Width Modifier	
Gallerie	L, R, C, D, P, X, T	G	1.18”(30mm) Additional Width
	W, E, H	1	0.59”(15mm) Additional Width
	K, J	3	1.77”(45mm) Additional Width
	U	4	2.36”(60mm) Additional Width
N Finished Face	I, S, M	S	0.00”(0mm) Additional Width

To Order, Specify:

- 1) Product number, including:

1 Mounting Options

- S** +0”(0mm)
- G** +1.18”(30mm) (add **\$4.85** list)
- 1** +0.59”(15mm) (add **\$2.43** list)
- 3** +1.77”(45mm) (add **\$7.29** list)
- 4** +2.36”(60mm) (add **\$9.72** list)

2 Glass Edge Options

- D** Dubbed
- R** Radius (add **\$144.05** list)

- 2) Insert color.

- 1C = Clear glass
- E21 = Satin Etch
- 1E = Frosted Acrylic

Panel Accessories

Insert Glass

Nominal Height	Nominal Width	Number ① ②	Clear Glass (1C)	Satin Etch (E21)	Frosted Acrylic (1E)
8"(203mm)	18"(457mm)	SYGG-0818- 4	\$ 479.70	\$ 874.00	\$ 1343.40
	24"(610mm)	SYGG-0824- 4	513.96	937.04	1440.68
	30"(762mm)	SYGG-0830- 4	548.22	1000.08	1537.96
	36"(914mm)	SYGG-0836- 4	582.48	1063.12	1635.24
	42"(1067mm)	SYGG-0842- 4	616.74	1126.16	1732.52
	48"(1219mm)	SYGG-0848- 4	651.00	1189.20	1829.80
	54"(1372mm)	SYGG-0854- 4	685.26	1252.24	1927.08
	60"(1524mm)	SYGG-0860- 4	719.52	1315.28	2024.36
	66"(1676mm)	SYGG-0866- 4	753.78	1378.32	2121.64
	72"(1829mm)	SYGG-0872- 4	788.04	1441.36	2218.92
	78"(1981mm)	SYGG-0878- 4	822.30	1504.40	2316.20
	84"(2134mm)	SYGG-0884- 4	856.56	1567.44	2413.48
	90"(2286mm)	SYGG-0890- 4	890.82	1630.48	2510.76
	96"(2438mm)	SYGG-0896- 4	925.08	1693.52	2608.04
102"(2591mm)	SYGG-08A2- 4	959.34	1756.56	2705.32	
108"(2743mm)	SYGG-08A8- 4	993.60	1819.60	2802.60	
114"(2896mm)	SYGG-08B4- 4	1027.86	1882.64	2899.88	
120"(3048mm)	SYGG-08C0- 4	1062.12	1945.68	2997.16	
12"(305mm)	18"(457mm)	SYGG-1218- 4	\$ 531.09	\$ 968.56	\$ 1489.32
	24"(610mm)	SYGG-1224- 4	582.48	1063.12	1635.24
	30"(762mm)	SYGG-1230- 4	633.87	1157.68	1781.16
	36"(914mm)	SYGG-1236- 4	685.26	1252.24	1927.08
	42"(1067mm)	SYGG-1242- 4	736.65	1346.80	2073.00
	48"(1219mm)	SYGG-1248- 4	788.04	1441.36	2218.92
	54"(1372mm)	SYGG-1254- 4	839.43	1535.92	2364.84
	60"(1524mm)	SYGG-1260- 4	890.82	1630.48	2510.76
	66"(1676mm)	SYGG-1266- 4	942.21	1725.04	2656.68
	72"(1829mm)	SYGG-1272- 4	993.60	1819.60	2802.60
	78"(1981mm)	SYGG-1278- 4	1044.99	1914.16	2948.52
	84"(2134mm)	SYGG-1284- 4	1096.38	2008.72	3094.44
	90"(2286mm)	SYGG-1290- 4	1147.77	2103.28	3240.36
	96"(2438mm)	SYGG-1296- 4	1199.16	2197.84	3386.28
102"(2591mm)	SYGG-12A2- 4	1250.55	2292.40	3532.20	
108"(2743mm)	SYGG-12A8- 4	1301.94	2386.96	3678.12	
114"(2896mm)	SYGG-12B4- 4	1353.33	2481.52	3824.04	
120"(3048mm)	SYGG-12C0- 4	1404.72	2576.08	3969.96	
16"(406mm)	18"(457mm)	SYGG-1618- 4	\$ 582.48	\$ 1063.12	\$ 1635.24
	24"(610mm)	SYGG-1624- 4	651.00	1189.20	1829.80
	30"(762mm)	SYGG-1630- 4	719.52	1315.28	2024.36
	36"(914mm)	SYGG-1636- 4	788.04	1441.36	2218.92
	42"(1067mm)	SYGG-1642- 4	856.56	1567.44	2413.48
	48"(1219mm)	SYGG-1648- 4	925.08	1693.52	2608.04
	54"(1372mm)	SYGG-1654- 4	993.60	1819.60	2802.60
	60"(1524mm)	SYGG-1660- 4	1062.12	1945.68	2997.16
	66"(1676mm)	SYGG-1666- 4	1130.64	2071.76	3191.72
	72"(1829mm)	SYGG-1672- 4	1199.16	2197.84	3386.28
	78"(1981mm)	SYGG-1678- 4	1267.68	2323.92	3580.84
	84"(2134mm)	SYGG-1684- 4	1336.20	2450.00	3775.40
	90"(2286mm)	SYGG-1690- 4	1404.72	2576.08	3969.96
	96"(2438mm)	SYGG-1696- 4	1473.24	2702.16	4164.52
102"(2591mm)	SYGG-16A2- 4	1541.76	2828.24	4359.08	
108"(2743mm)	SYGG-16A8- 4	1610.28	2954.32	4553.64	
114"(2896mm)	SYGG-16B4- 4	1678.80	3080.40	4748.20	
120"(3048mm)	SYGG-16C0- 4	1747.32	3206.48	4942.76	

Panel Accessories

Panel Hanging Brackets

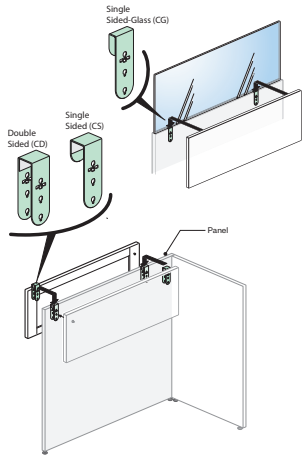

SYWB
Class YA - GSA; Open Market

Features

- Includes one bracket.
- Brackets allow attachment of components to panel without leaving holes in the panel.

Specification Tips

- Designed to mount on Gallerie and, Compose Gallery panels (Compose Price List) and Belong Gallery End Panels (Screens and Space Division Price List).
- Single and Double Sided Finished Top brackets are designed for use on a panel finished top. Not for use with panels specified with Glass Ready option. Not recommended for use with Topper Kit due to installation sequence.
- Designed to hang the following, separately specified:
 - Compose Fabric Tile (VZTI-FNN)
 - Compose Markerboard Tile (VZTI-MNN)
 - Wall Mount Tackboard (KUAF)
 - Wall Mount Markerboard (KUAM)
 - Compose Echo Tackboard (STUT)
- See Application Guide for vertical and horizontal offset by component.
- Bracket supported components may span more than one in-line panel. Bracket can mount on a panel in-line seam.
 - Use two brackets per component. Use three brackets if component is 72"(1829mm) and greater.
- When using Double Sided Bracket, components must be the same on both sides. Cannot mix components.

To Order, Specify:

- 1) Product number.
- 2) Trim color.

Description	Number	Trim	
		A	B
Single Sided - Finished Top	SYWB-0000-CS	\$49.00	\$54.00
Double Sided - Finished Top	SYWB-0000-CD	54.00	59.00
Single Sided - Inset/Frameless Glass	SYWB-0000-CG	51.00	56.00

Panel Accessories

Height Adjustable Table Tie

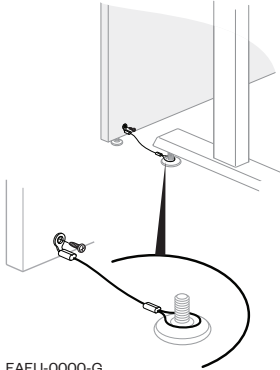

EAEU-0000-G
Class BC

Feature

- Includes one coated metal table tie and attachment hardware.

Specification Tips

- Ties height adjustable table to panel.
- Required when conduit is running to the bottom of the height adjustable table.
- Mechanical attachment located at the end of the table nearest the power source.

To Order, Specify:

- 1) Product number.
(No color specification required.)

	Number	Price
	EAEU-0000-G	\$95.00

Connection Conversion Kit

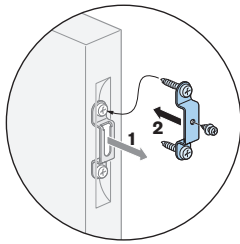

GSFM-0000-N
Class BC

Feature

- Includes hardware for one conversion.

Specification Tip

- Converts a female connection to a male connection.

To Order, Specify:

- 1) Product number.
(No color specification required.)

	Number	Price
	GSFM-0000-N	\$105.00

Glass Channel Filler

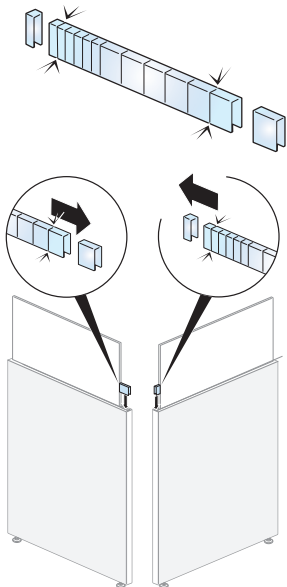

SYGF-0000-4
Class BC

Feature

- Includes one pack of six 1.335"(34mm) and six .425"(11mm) fillers.

Specification Tip

- Use glass channel fillers to help align the end of a glass insert with the end of a perpendicular glass application.

To Order, Specify:

- 1) Product number.
(No color specification required.)

Nominal Width	Number	Price
0.335"(9mm)	SYGF-0000-4	\$125.00

Power and Data Management

Power Console At-A-Glance

The **Power Console** provides a clean, integrated solution for routing and concealing power and data along a spine of Haworth Gallerie. Powered consoles house the **Power Distribution Assembly (PDA)**, which supports **1-10 receptacles** and allows power to be distributed directly at the console or routed to adjacent applications using conduit jumpers, receptacles, or worksurface mounted PDAs. Power Consoles are available for hardwired applications.

Power may continue beyond the console through conduit jumpers, and up to 20 or **26 total receptacles** can be supported from a single infeed (13 per circuit USA or 10 per circuit Canada).

Spaces along the spine can consist of consoles, storage, or open spaces. If power is run between consoles in open spaces the power can be concealed with storage utilizing a top to create a 2" power and data pathway. Horizontal and vertical trim components coordinate storage height/depth transitions adjacent to consoles.

Single Stage Height-Adjustable Tables (HATs) may be used in line with the Power Console when specified with the **18"H Laminate Front**, which enables HAT feet to slide beneath the console for proper alignment. (Dual stage HATs must not overlap the top of the console.)

Routing power outside the console requires the use of a **DualCircuit Conduit Jumper and/or PDA**.

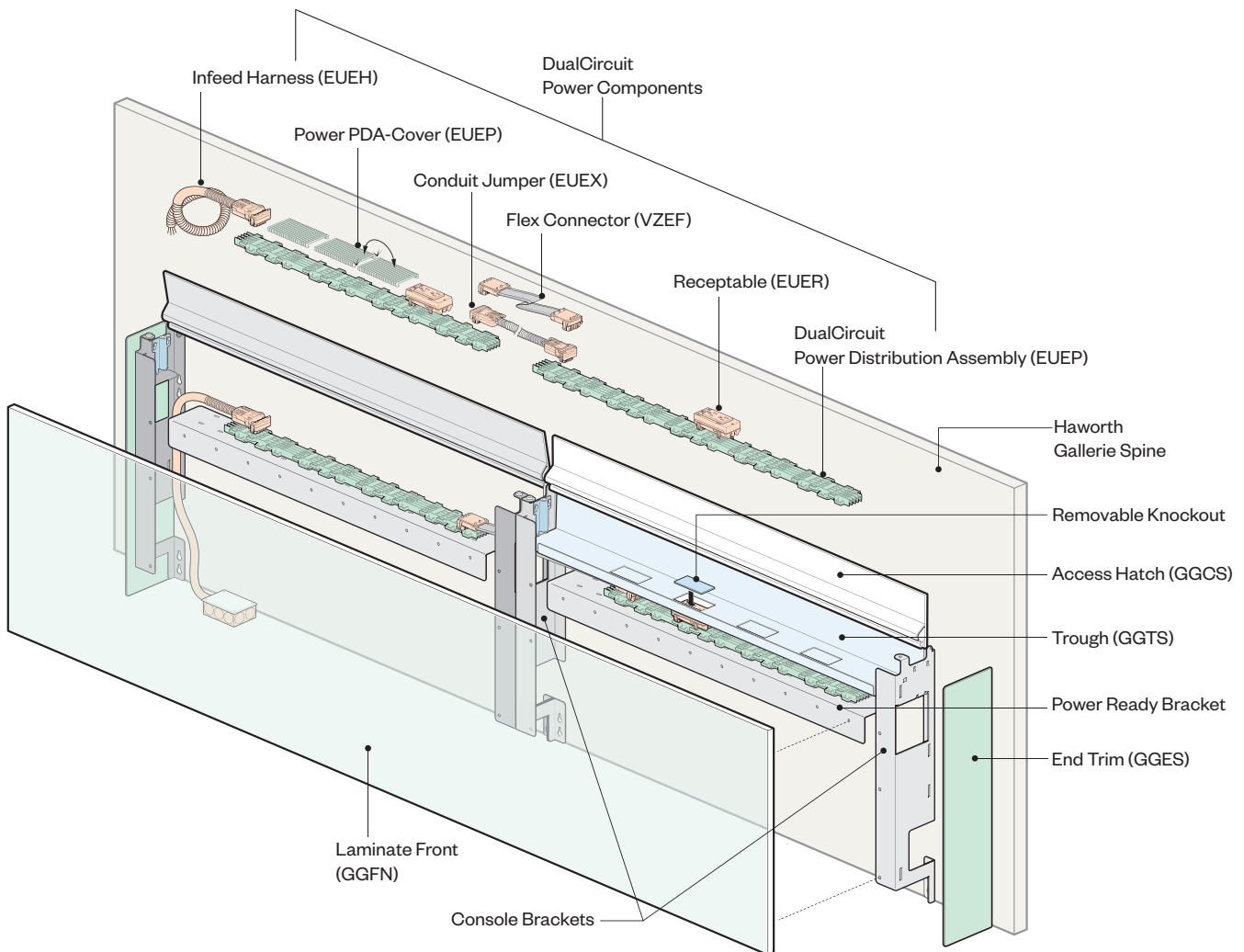

Power and Data Management

Power Console

Core

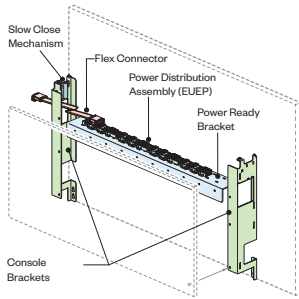

GGPS
Class BC

Features

- Includes a powered or non-powered Power Console Core:
 - Powered includes:
 - Power Distribution Assembly (PDA)
 - Slow close mechanism
 - Flex connector
 - Power ready bracket
 - Console brackets
 - Non-powered includes:
 - Slow close mechanism
 - Power ready bracket
 - Console brackets
- Field installed.

Specification Tips

- Requires separately specified Access Hatch. Access Hatch length must match the length of the core.
- For use on the spine of a panel application.
- Application may require approval of local authority having jurisdiction –(AHJ); ensure compliance before placing orders and installation.
- Separately Specify:
 - Required:
 - Access Hatch
 - Laminate Front
 - Optional:
 - Receptacle and Data Blank Cover
 - Trough
 - End Trim
 - Conduit Jumpers
 - Receptacles
 - Receptacle Data Kit
 - Power Infeeds

To Order, Specify:

1) Product number, including:

1 Power Options:

- U** Non-Powered (Hardwire)
- 9** DualCircuit Power

Height	Depth	PDA Size	Receptacle Quantity	Width	Number ①	Price
20"(508mm)	5"(127mm)	12"(305mm)	1	18"(457mm)	GGPS-2018- S	\$ 635.59
		18"(457mm)	2	21"(533mm)	GGPS-2021- S	658.60
		18"(457mm)	2	24"(610mm)	GGPS-2024- S	681.61
		24"(610mm)	3	27"(686mm)	GGPS-2027- S	704.62
		24"(610mm)	3	30"(762mm)	GGPS-2030- S	727.63
		30"(762mm)	4	33"(838mm)	GGPS-2033- S	750.64
		30"(762mm)	4	36"(914mm)	GGPS-2036- S	773.65
		36"(914mm)	5	39"(991mm)	GGPS-2039- S	796.66
		36"(914mm)	5	42"(1067mm)	GGPS-2042- S	819.67
		42"(1067mm)	6	45"(1143mm)	GGPS-2045- S	842.68
		42"(1067mm)	6	48"(1219mm)	GGPS-2048- S	865.69
		48"(1219mm)	7	51"(1295mm)	GGPS-2051- S	888.70
		48"(1219mm)	7	54"(1372mm)	GGPS-2054- S	911.71
		54"(1372mm)	8	57"(1448mm)	GGPS-2057- S	934.72
		54"(1372mm)	8	60"(1524mm)	GGPS-2060- S	957.73
		60"(1524mm)	9	63"(1600mm)	GGPS-2063- S	980.74
		60"(1524mm)	9	66"(1676mm)	GGPS-2066- S	1003.75
		66"(1676mm)	10	69"(1753mm)	GGPS-2069- S	1026.76
		66"(1676mm)	10	72"(1829mm)	GGPS-2072- S	1049.77

Power and Data Management

Power Console

Access Hatch

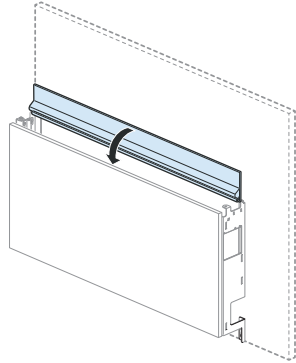

GGCS
Class BC

Features

- Includes hatch.
- Hatch is painted.

Specification Tip

- Match Console and Access Hatch widths.

To Order, Specify:

- 1) Product number.
- 2) Trim color.

Depth	Width	Number	Trim	
			A	B
4"(102mm)	18"(457mm)	GGCS-0018-P	\$ 316.05	\$ 319.05
	21"(533mm)	GGCS-0021-P	326.91	332.91
	24"(610mm)	GGCS-0024-P	337.77	346.77
	27"(686mm)	GGCS-0027-P	348.63	360.63
	30"(762mm)	GGCS-0030-P	359.49	374.49
	33"(838mm)	GGCS-0033-P	370.35	388.35
	36"(914mm)	GGCS-0036-P	381.21	402.21
	39"(991mm)	GGCS-0039-P	392.07	416.07
	42"(1067mm)	GGCS-0042-P	402.93	429.93
	45"(1143mm)	GGCS-0045-P	413.79	443.79
	48"(1219mm)	GGCS-0048-P	424.65	457.65
	51"(1295mm)	GGCS-0051-P	435.51	471.51
	54"(1372mm)	GGCS-0054-P	446.37	485.37
	57"(1448mm)	GGCS-0057-P	457.23	499.23
	60"(1524mm)	GGCS-0060-P	468.09	513.09
	63"(1600mm)	GGCS-0063-P	478.95	526.95
	66"(1676mm)	GGCS-0066-P	489.81	540.81
	69"(1753mm)	GGCS-0069-P	500.67	554.67
	72"(1829mm)	GGCS-0072-P	511.53	568.53

Power and Data Management

Power Console

Laminate Front

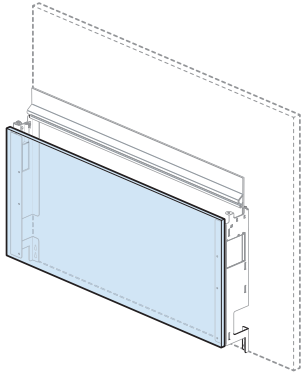

GGFN
Class BC

Features

- Includes laminate front with 1mm edgeband.
- Field installed.

Specification Tips

- For use with Power Console.
- 18"(457mm) and 20"(508mm)H
- Use the 18"(457mm)H laminate front when a height adjustable table (HAT) is placed parallel to the Power Console. The gap at the floor allows the table feet to slide under the console. Verify the required pinch-point clearance for the HAT is maintained. Use the 20"(508mm)H laminate front in all other applications to provide a clean, enclosure to the floor.
- The Power Console - Laminate Front may span up to two Power Console - Core and the top of console top feed.
- Power Console Core must be fully covered by Laminate Front. Attaches to end of core only.

To Order, Specify:

- 1) Product number.
- 2) Laminate finish color.
- 3) Edge trim color.

Depth	Width	Number	HPL	
			A	B
18"(457mm)	18"(457mm)	GGFN-1818-L	\$ 463.95	\$ 522.87
	21"(533mm)	GGFN-1821-L	490.62	560.64
	24"(610mm)	GGFN-1824-L	517.29	598.41
	27"(686mm)	GGFN-1827-L	543.96	636.18
	30"(762mm)	GGFN-1830-L	570.63	673.95
	33"(838mm)	GGFN-1833-L	597.30	711.72
	36"(914mm)	GGFN-1836-L	623.97	749.49
	39"(991mm)	GGFN-1839-L	650.64	787.26
	42"(1067mm)	GGFN-1842-L	677.31	825.03
	45"(1143mm)	GGFN-1845-L	703.98	862.80
	48"(1219mm)	GGFN-1848-L	730.65	900.57
	51"(1295mm)	GGFN-1851-L	757.32	938.34
	54"(1372mm)	GGFN-1854-L	783.99	976.11
	57"(1448mm)	GGFN-1857-L	810.66	1013.88
	60"(1524mm)	GGFN-1860-L	837.33	1051.65
	63"(1600mm)	GGFN-1863-L	864.00	1089.42
	66"(1676mm)	GGFN-1866-L	890.67	1127.19
	69"(1753mm)	GGFN-1869-L	917.34	1164.96
	72"(1829mm)	GGFN-1872-L	944.01	1202.73
	75"(1905mm)	GGFN-1875-L	970.68	1240.50
78"(1981mm)	GGFN-1878-L	997.35	1278.27	
81"(2057mm)	GGFN-1881-L	1024.02	1316.04	
84"(2134mm)	GGFN-1884-L	1050.69	1353.81	
87"(2210mm)	GGFN-1887-L	1077.36	1391.58	
90"(2286mm)	GGFN-1890-L	1104.03	1429.35	
93"(2362mm)	GGFN-1893-L	1130.70	1467.12	
96"(2438mm)	GGFN-1896-L	1157.37	1504.89	
99"(2515mm)	GGFN-1899-L	1184.04	1542.66	
102"(2591mm)	GGFN-18A2-L	1210.71	1580.43	
105"(2667mm)	GGFN-18A5-L	1237.38	1618.20	
108"(2743mm)	GGFN-18A8-L	1264.05	1655.97	
111"(2819mm)	GGFN-18B1-L	1290.72	1693.74	
114"(2896mm)	GGFN-18B4-L	1317.39	1731.51	
117"(2972mm)	GGFN-18B7-L	1344.06	1769.28	
120"(3048mm)	GGFN-18C0-L	1370.73	1807.05	

Power and Data Management

Power Console

Depth	Height	Number	HPL	
			A	B
20"(508mm)	18"(457mm)	GGFN-2018-L	\$ 483.95	\$ 545.71
	21"(533mm)	GGFN-2021-L	510.62	583.48
	24"(610mm)	GGFN-2024-L	537.29	621.25
	27"(686mm)	GGFN-2027-L	563.96	659.02
	30"(762mm)	GGFN-2030-L	590.63	696.79
	33"(838mm)	GGFN-2033-L	617.30	734.56
	36"(914mm)	GGFN-2036-L	643.97	772.33
	39"(991mm)	GGFN-2039-L	670.64	810.10
	42"(1067mm)	GGFN-2042-L	697.31	847.87
	45"(1143mm)	GGFN-2045-L	723.98	885.64
	48"(1219mm)	GGFN-2048-L	750.65	923.41
	51"(1295mm)	GGFN-2051-L	777.32	961.18
	54"(1372mm)	GGFN-2054-L	803.99	998.95
	57"(1448mm)	GGFN-2057-L	830.66	1036.72
	60"(1524mm)	GGFN-2060-L	857.33	1074.49
	63"(1600mm)	GGFN-2063-L	884.00	1112.26
	66"(1676mm)	GGFN-2066-L	910.67	1150.03
	69"(1753mm)	GGFN-2069-L	937.34	1187.80
	72"(1829mm)	GGFN-2072-L	964.01	1225.57
	75"(1905mm)	GGFN-2075-L	990.68	1263.34
	78"(1981mm)	GGFN-2078-L	1017.35	1301.11
	81"(2057mm)	GGFN-2081-L	1044.02	1338.88
	84"(2134mm)	GGFN-2084-L	1070.69	1376.65
	87"(2210mm)	GGFN-2087-L	1097.36	1414.42
	90"(2286mm)	GGFN-2090-L	1124.03	1452.19
	93"(2362mm)	GGFN-2093-L	1150.70	1489.96
	96"(2438mm)	GGFN-2096-L	1177.37	1527.73
	99"(2515mm)	GGFN-2099-L	1204.04	1565.50
	102"(2591mm)	GGFN-20A2-L	1230.71	1603.27
	105"(2667mm)	GGFN-20A5-L	1257.38	1641.04
	108"(2743mm)	GGFN-20A8-L	1284.05	1678.81
	111"(2819mm)	GGFN-20B1-L	1310.72	1716.58
	114"(2896mm)	GGFN-20B4-L	1337.39	1754.35
	117"(2972mm)	GGFN-20B7-L	1364.06	1792.12
	120"(3048mm)	GGFN-20C0-L	1390.73	1829.89

Power and Data Management

Power Console

Trough

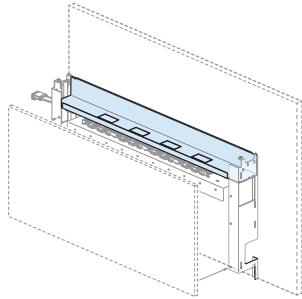

GGTS
Class BC

Features

- Includes metal trough with removable knockouts.
- Standard in Charcoal TR-K.
- Field installed.

Specification Tips

- Must match the width of the core.
- Used to hide the power distribution assembly (PDA). PDA installs in the Power Console - Core.
- Receptacle and Data Blank Cover can be used to cover holes after the knockout is removed.
- Separately Specify:
 - Required:
 - Access Hatch
 - Laminate Front
 - Core
 - Optional:
 - Receptacle and Data Blank Cover
 - Receptacles

To Order, Specify:

- 1) Product number.
(No color specification required.)
- 2) Trim color.
Charcoal TR-K

Height	Number of Knockout(s)	Width	Number	Price
20"(508mm)	1	18"(457mm)	GGTS-0018-PT	\$ 176.58
	2	21"(533mm)	GGTS-0021-PT	183.90
	2	24"(610mm)	GGTS-0024-PT	191.22
	3	27"(686mm)	GGTS-0027-PT	198.54
	3	30"(762mm)	GGTS-0030-PT	205.86
	4	33"(838mm)	GGTS-0033-PT	213.18
	4	36"(914mm)	GGTS-0036-PT	220.50
	5	39"(991mm)	GGTS-0039-PT	227.82
	5	42"(1067mm)	GGTS-0042-PT	235.14
	6	45"(1143mm)	GGTS-0045-PT	242.46
	6	48"(1219mm)	GGTS-0048-PT	249.78
	7	51"(1295mm)	GGTS-0051-PT	257.10
	7	54"(1372mm)	GGTS-0054-PT	264.42
	8	57"(1448mm)	GGTS-0057-PT	271.74
	8	60"(1524mm)	GGTS-0060-PT	279.06
	9	63"(1600mm)	GGTS-0063-PT	286.38
	9	66"(1676mm)	GGTS-0066-PT	293.70
	10	69"(1753mm)	GGTS-0069-PT	301.02
	10	72"(1829mm)	GGTS-0072-PT	308.34

End Trim

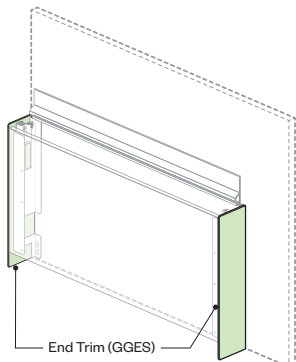

GGES
Class BC

Feature

- Includes cover and attachment hardware.

Specification Tips

- **For use when the power console is exposed and an end-of-run condition requires the console to be finished.**
- Cover is the full height and depth of the power console.
- End trim adds .1"(3mm) thickness to width of the power console.
- Do not use adjacent to other furniture.

To Order, Specify:

- 1) Product number.
- 2) Trim color.

Height	Number	Trim A	B
20"(508mm)	GGES-2000-P	\$225.00	\$250.00

Power and Data Management Filler Trim

Variable — Vertical

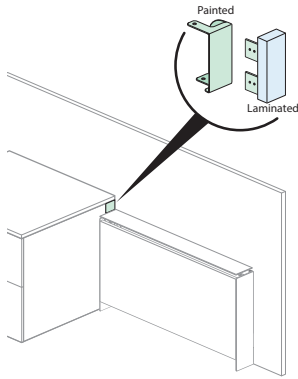

GGIV
Class BC

Features

- Includes trim and attachment hardware.
- Cover is painted or laminated with edgeband.

Specification Tips

- Trim accommodates a range of height differences. The measurement is from the top of the console to the top of the storage.
- 1.5"(38mm)H and 2"(51mm)H storage use specific conditions, see Specification Guide for application guidelines.

To Order, Specify:

- 1) Product number.
- 2) Trim or laminate color.

Depth	Height	Number	Trim	
			A	B
Paint				
2"(51mm)	3"(76mm)	GGIV-0203-P	\$ 88.47	\$ 90.47
	6"(152mm)	GGIV-0206-P	97.47	102.47
	9"(229mm)	GGIV-0209-P	106.47	114.47

Depth	Height	Number	HPL	
			A	B
Laminate				
2"(51mm)	3"(76mm)	GGIV-0203-L	\$250.00	\$280.00
	6"(152mm)	GGIV-0206-L	259.00	292.75
	9"(229mm)	GGIV-0209-L	268.00	305.50

Horizontal

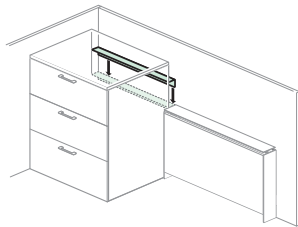

GGIZ
Class BC

Feature

- Includes trim and attachment hardware.

Specification Tips

- For use with power console and storage greater than 2"(51mm)H.
- Attaches to the panel.
- When using adjacent to power console must align to the top of the access hatch.
- When installed adjacent to storage with a common top, align to the top of the common top.
- Filler trim will push storage out 2"(51mm).
- Match the storage width.

To Order, Specify:

- 1) Product number.
- 2) Trim color.

Depth	Width	Number	Trim	
			A	B
2"(51mm)	12"(305mm)	GGIZ-0212-P	\$ 160.00	\$ 165.00
	15"(381mm)	GGIZ-0215-P	164.20	172.20
	18"(457mm)	GGIZ-0218-P	168.40	179.40
	24"(610mm)	GGIZ-0224-P	176.80	193.80
	30"(762mm)	GGIZ-0230-P	185.20	208.20
	36"(914mm)	GGIZ-0236-P	193.60	222.60
	42"(1067mm)	GGIZ-0242-P	202.00	237.00

Electrical Components

Infeed Module Stacking — DualCircuit — Hardwire Connection

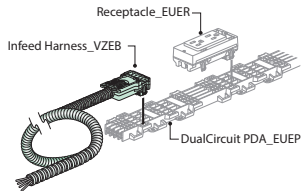

EUEH



Class BC

Features

- Includes one Infeed with 0.5”(13mm) flexible metal conduit.
- The 0.5”(13mm) Conduit for Infeed includes four 12-gauge wires for up to two 20-Amp circuits of power.
- For use with panels equipped with power components.
- For hardwire connection to building power at floor, column, wall, or ceiling locations.
- Attaches to any site on a DualCircuit Power Distribution Assembly (EUEP) with conduit exiting on the left of connector.
- Connector is standard in charcoal trim only; the conduit is unpainted galvanized steel.

Specification Tips

- For use with 120 Volt 60 Hz power sources only.
- Do not mix components from different wiring configurations.
- Application may require approval of local Authority Having Jurisdiction (AHJ); ensure compliance before placing orders and installation.

To Order, Specify:

- 1) Product number.
(No finish specification required.)

Description	Feed Length	Number	Price
DualCircuit			
Hardwire 20 Amp	48”(1219mm)	EUEH-0000-H9	\$439.79
	72”(1829mm)	EUEH-0006-H9	459.79
	120”(3048mm)	EUEH-0010-H9	499.79
	180”(4572mm)	EUEH-0015-H9	549.79
	300”(7620mm)	EUEH-0025-H9	649.79

Top Feed Pole for Gallerie

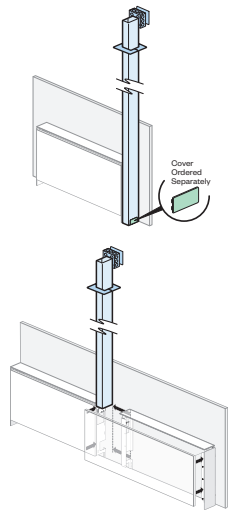

GGET

Class TA

Features

- Includes one electrical box, ceiling bezel plate, pole, and hardware.
- Allows for connection to the electrical source located in space above a drop ceiling.
- Allows for routing of data cables.
- Removable cover on pole provides access to pathway. To cover hole separately specify a Receptacle and Data Blank Cover.
- Mounting options include:
 - Floor Mount
 - To top of console front cover
 - To top of worksurface

Specification Tips

- **For use with Haworth Gallerie Panels only.**
- Infeed harness is separately specified.
- All mounting applications require attachment to a panel. The 3”(76mm) attachment cover mounts to the panel. Cutouts are located on both sides of the 4.5”(114mm) outer cover. Use the separately specified Receptacle and Data Blank Cover (Dual Circuit) (VZAR-0000-9) to fill an unused cutout.
- Hardwire Applications: conduit, fittings, wiring, etc. are field supplied and installed.
- Floor attachment hardware is field supplied.
- Application may require approval of local Authority Having Jurisdiction (AHJ); ensure compliance before placing orders and installation.

To Order, Specify:

- 1) Product number.
 - 1** **Cutout:**
 - N** No Cutout
 - E** Cutout on Both Sides
- 2) Trim color.

Description	Ceiling Height	Pole Length	Pole Pieces	Number	1	Trim A	B
Floor mount							
	10”(3048mm)	120”(3048mm)	2	GGET-S000-NT		\$1349.60	\$1439.60
	12”(3658mm)	144”(3658mm)	2	GGET-S000-NW		1549.52	1657.52
Top of Power Console or worksurface (no cutouts)							
	10”(3048mm)	120”(3048mm)	2	GGET-S020-NTN		\$1033.00	\$1108.00
	12”(3658mm)	144”(3658mm)	2	GGET-S020-NWN		1232.92	1325.92

Electrical Components

Concealed Base Feed Module — Hardwire Connection — Connections and Beam

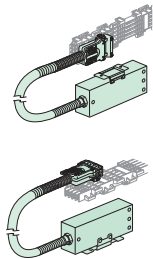

EUEB-0000-9HY



Class BC

Features

- Includes one junction box with three 0.5”(13mm) knockouts, 20”(508mm) flexible metal conduit, and modular non-stacking connector.
- Conduit for Infeed includes four 12-gauge wires for up to two 20-Amp circuits of power.
- For use with components equipped with power components. Conforms to New York City electrical code.
- For hardwire connection to building power at floor, column, or wall locations.

Specification Tips

- For use with 120 Volt 60 Hertz power sources only.
- Conduit and fittings for connection between building and junction box are field supplied.
- Do not mix components from different wiring configurations.
- Application may require approval of local Authority Having Jurisdiction (AHJ); ensure compliance before placing orders and installation.

To Order, Specify:

- 1) Product number.
(No finish specification required.)

Description	Conduit Length	Number	Price
DualCircuit	20”(508mm)	EUEB-0000-9HY	\$457.24

Single Circuit Base Feed Module — Receptacle Connection with Power Cord (USA Only)

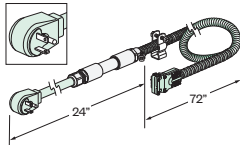

VZEB-0000-29



Class BC

Features

- Includes a single circuit power connector, 72”(1829mm) flexible metal conduit, inline barrel connector, 24”(610mm) cord, and 20 amp plug NEMA 5-20P configuration.
- For use with Power Distribution Assemblies.
- Requires a 20-amp, 125-volt power receptacle (NEMA 5-20R) for plug-in (not included).
- Attaches to any connection point of a Power Distribution Assembly.
- Provides power to circuit #1 only.
- Standard in charcoal trim color only.

Specification Tips

- For use with 120-volt 60 hertz power sources only.
- Not for use in Canada due to electrical code restrictions.
- Do not mix components from different wiring configurations.
- Application may require approval of local authority having jurisdiction (AHJ); ensure compliance before placing orders and installation.

To Order, Specify:

- 1) Product number.
(No finish specification required.)

Description	Feed Length	Number	Price
DualCircuit Cord Feed 20 Amp (USA Only)	2”(610mm)	VZEB-0000-29	\$ 675.15

Single Circuit Base Feed Module — Receptacle Connection with Power Cord (Canada Only)

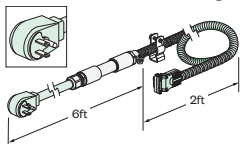

VZEB-0000-19



Class BC

Features

- Includes a single circuit power connector, 24”(610mm) flexible metal conduit, inline barrel connector, 72”(1829mm) cord, and 20 amp plug NEMA 5-15P configuration.
- For use with Power Distribution Assemblies.
- Requires a 15-amp, 125-volt power receptacle (NEMA 5-15R) for plug-in (not included).
- Attaches to any connection point of a Power Distribution Assembly.
- Provides power to circuit #1 only.
- Standard in charcoal trim color only.

Specification Tips

- For use with 120-volt 60 hertz power sources only.
- Not for use in USA due to electrical code restrictions.
- Do not mix components from different wiring configurations.
- Application may require approval of local authority having jurisdiction (AHJ); ensure compliance before placing orders and installation.

To Order, Specify:

- 1) Product number.
(No finish specification required.)

Description	Feed Length	Number	Price
DualCircuit Cord Feed 15 Amp (Canada Only)	6”(1829mm)	VZEB-0000-19	\$750.54

Electrical Components

Power Distribution Assembly Kit

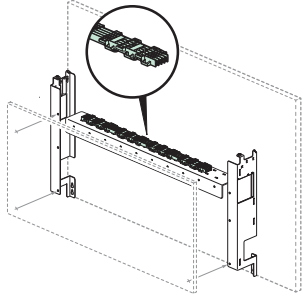

EUEP



Class BC

Features

- Includes one Power Distribution Assembly (PDA).
- Use in Console or can be mounted in a variety of locations, see Specification Guide for details.

Specification Tips

- For use with 120 Volt 60 Hz power sources only.
- Allows for connection of one receptacle for every six inches of length. Receptacles can only be installed at locations that offer three latch points to secure receptacles.
- Refer to Specification Guide for DualCircuit planning.
- Separately specify receptacles, flex connectors, jumpers, and covers.
- Flex connectors can only be used with Consoles only.
- Covers are available for use as a power break marker or to cover unused portions of the PDA.
- Visible conductors meet UL and CSA standards for safe use.
- Do not mix components from different wiring configurations.
- Application may require approval of local Authority Having Jurisdiction (AHJ); ensure compliance before placing orders and installation.

To Order, Specify:

- 1) Product number.
(No finish specification required.)

PDA Width	Number of Receptacles that fit	Number	Price
6"(152mm)	0	EUEP-0006-9S	\$ 41.86
12"(305mm)	1	EUEP-0012-9S	56.12
18"(457mm)	2	EUEP-0018-9S	70.48
24"(610mm)	3	EUEP-0024-9S	84.74
30"(762mm)	4	EUEP-0030-9S	99.09
36"(914mm)	5	EUEP-0036-9S	113.36
42"(1067mm)	6	EUEP-0042-9S	127.62
48"(1219mm)	7	EUEP-0048-9S	141.98
54"(1372mm)	8	EUEP-0054-9S	156.24
60"(1524mm)	9	EUEP-0060-9S	170.59
66"(1676mm)	10	EUEP-0066-9S	184.86
72"(1829mm)	11	EUEP-0072-9S	199.12
78"(1981mm)	12	EUEP-0078-9S	213.48
84"(2134mm)	13	EUEP-0084-9S	227.74
90"(2286mm)	14	EUEP-0090-9S	242.09
96"(2438mm)	15	EUEP-0096-9S	256.36

Electrical Components

Flexible Power Connector — DualCircuit

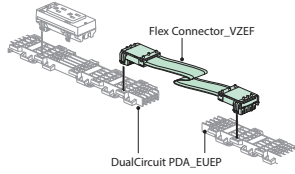

VZEF

 Class BC

Features

- Includes one flexible power connector with safety latches for securing connector to power distribution assembly.
- Continues electrical circuits between adjacent Power Distribution Assemblies in the Console only.
- Standard in charcoal trim only.

Specification Tips

- For use with Power Console only.
- For use with 120 Volt 60 Hz power sources only.
- For use with Power Console only, this includes routing between back-to-back Consoles on either side of a panel. Field drilling of panel required to route Flex Connector.
- Do not mix components from different wiring configurations.
- Application may require approval of local Authority Having Jurisdiction (AHJ); ensure compliance before placing orders and installation.

To Order, Specify:

- 1) Product number.
(No finish specification required.)

Length	Number	Price
19"(483mm)	VZEF-000C-9	\$ 139.05

Conduit Jumper — DualCircuit

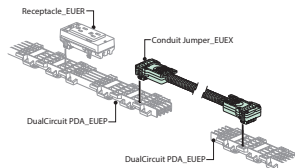

EUEX
 Class YA

Features

- Includes one power connector with safety latches for securing connector.
- Use with products equipped with power components.

Specification Tips

- For use with 120 Volt 60 Hz power sources only.
- For use with the following DualCircuit power options in Haworth Gallerie Panels:
 - Linking Power Distribution Assemblies
 - Linking Power Distribution Assemblies or receptacles attached to horizontal and/or vertical surfaces on panels, height adjustable tables without casters, adaptable worksurfaces, and storage.
- When using jumper to electrically connect furniture components, the components must also be mechanically connected.
- Refer to Specification Guide for calculations of jumper length.
- Separately specify Height Adjustable Table Ties, Conduit Clamps, and Grommets.
- Do not mix components from different wiring configurations.
- Application may require approval of local Authority Having Jurisdiction (AHJ); ensure compliance before placing orders and installation.

To Order, Specify:

- 1) Product number.
(No finish specification required.)

Actual Length	Number	Price
24"(610mm)	EUEX-J024-9	\$ 281.02
48"(1219mm)	EUEX-J048-9	317.05
72"(1829mm)	EUEX-J072-9	353.01
96"(2438mm)	EUEX-J096-9	389.04
120"(3048mm)	EUEX-J120-9	425.06
144"(3658mm)	EUEX-J144-9	461.02
168"(4267mm)	EUEX-J168-9	497.05
192"(4877mm)	EUEX-J192-9	533.01
216"(5486mm)	EUEX-J216-9	569.04
240"(6096mm)	EUEX-J240-9	605.06
264"(6706mm)	EUEX-J264-9	641.02
288"(7315mm)	EUEX-J288-9	677.05
312"(7925mm)	EUEX-J312-9	713.01
336"(8534mm)	EUEX-J336-9	749.04
360"(9144mm)	EUEX-J360-9	785.06
384"(9754mm)	EUEX-J384-9	821.02

Electrical Components

Receptacle — 15 Amp

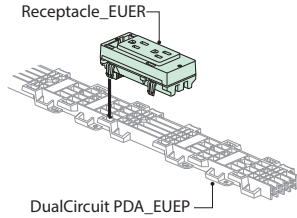

EUER-15
Class YAll



Features

- Includes box of six receptacles, each receptacle has two 15-Amp outlets (NEMA 5-15R configuration).
- Use with Power Distribution Assemblies, and Jumpers or Infeeds with Stack feature.
- Accesses common ground only.

Specification Tips

- For use with 120 Volt 60 Hz power sources only.
- When used on Power Distribution Assemblies (PDA), the receptacle must plug into a location that utilizes all three retention clips on receptacle, there is one every 6”(152mm) along the PDA.
- Do not mix components from different wiring configurations.
- Receptacles can only be mounted horizontally (facing upwards) in the Console.
- Receptacles identified with either the number 1 or 2 to indicate which circuit they access.
- A maximum of 13 receptacles per circuit are allowed in USA.
- A maximum of 10 receptacles per circuit are allowed in Canada.
- Controlled receptacles are marked with a permanent symbol and the word CONTROLLED to comply with various energy code requirements including ASHRAE 90.1 and California Building Code Title 24 Part 6.
- Circuit assignment and receptacle placement should be coordinated with a local electrician. Local electricians are responsible for circuit loading and code compliance.
- Application may require approval of local Authority Having Jurisdiction (AHJ); ensure compliance before placing orders and installation.

To Order, Specify:

1) Product number.

2) Trim color.

TR-K Charcoal*

TR-G Gray Tone*

TR-TW Plaster*

TR-AA Putty*

TR-E Smoke*

*DualCircuit Duplex trim colors.

Description	Circuit Access	Ground Type	Receptacle without Controlled Symbol	Price	Receptacle with Controlled Symbol	Price
DualCircuit - Duplex						
	Circuit 1	Common	EUER-1591-GSOS	\$164.74	EUER-1591-GCOS	\$169.24
	Circuit 2	Common	EUER-1592-GSOS	164.74	EUER-1592-GCOS	169.24

Electrical Components

Receptacle Data Kit

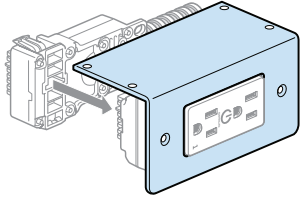

EUAK

Features

- Includes bracket and mounting hardware.
- Must be field-installed.
- Standard in black.

Specification Tips

- Designed to mount one receptacle or data plate.
- Can be vertically mounted to a panel or under a worksurface.

To Order, Specify:

- 1) Product number.
(No finish specification required.)

Number	Price
EUAK-0000-9	\$18.00

Receptacle and Data Blank Cover (DualCircuit)

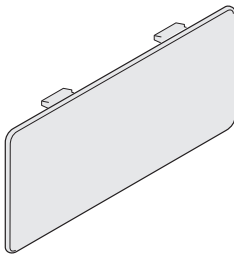

VZAR-0000-9
Class BC

Features

- Includes one cover.
- Used to cover unused electrical openings at all receptacle locations.

To Order, Specify:

- 1) Product number.
- 2) Trim color.

- TR-K Charcoal
- TR-G Gray Tone
- TR-TW Plaster
- TR-AA Putty
- TR-E Smoke

Height	Width	Number	Price
2.25"(57mm)	3"(76mm)	VZAR-0000-9	\$ 10.00

Cable Management — Vertical

Gallerie Power Console Cable Chain

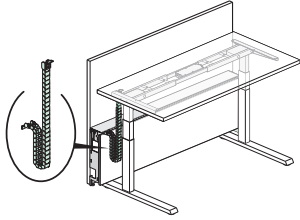

EUAW
Class YA

Features

- Includes 36"(914mm) active length cable chain, bracket and mounting hardware.
- Standard in black.

Specification Tips

- Mounts to Power Console laminate front and underside of adjacent worksurface or height adjustable table to contain power cords and data cables that are routed from inside the power console to an adjacent worksurface.
- Holds up to three power cords and two data cables.

To Order, Specify:

- 1) Product number.
(No finish specification required.)

Height	Width	Actual Length	Installed Length	Number	Price
0.75"(19mm)	2.25"(57mm)	40"(1016mm)	36"(914mm)	EUAW-0000-VG	\$385.00

Grommets

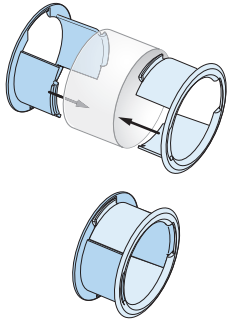

EUGK
Class TA

Features

- Includes two piece grommets.
- Standard in black.
- Must be field-installed.

Specification Tips

- Installs in the power cutout of a panel or a 2.5"(64mm) field cut diameter.
- Works with 1.18"(30mm) panels.

To Order, Specify:

- 1) Product number.
(No finish specification required.)

Outside Diameter	Hole Size	Number	Price
2.75"(70mm)	2.5"(64mm)	EUGK-0003-D	\$150.00

Power PDA Cover

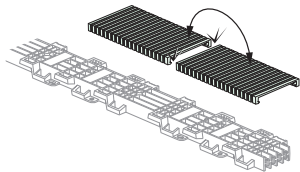

EUEP
Class BC

Features

- 12"(305mm) cover which can be cut to size.

Specification Tips

- Designed to cover unused openings in the PDA or as a power break maker.
- Size according to need.

To Order, Specify:

- 1) Product number.
(No finish specification required.)

Number	Price
EUEP-1	\$ 8.00

Conduit Clamp

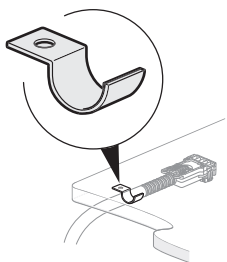

EUAM
Class YA

Features

- Includes 25 clamps and 25 screws.
- For managing cord or conduit under horizontal surfaces.

To Order, Specify:

- 1) Product number.
(No finish specification required.)

Number	Price
EUAM-0000	\$102.95

Cable Management — Horizontal

Dual-Hinged Cable Management Tray — Application Chart

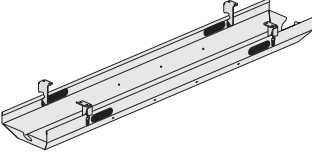
Product Name	Approved Table Depths	Approved Table Widths	Reduce Tray Width Leg Clearance	Example Calculation To Determine Tray Width	
	Upside - Height Adjustable Table C-Leg and T-Leg/ Rectangle Top	29"(737mm)	46"(1168mm), 52"(1321mm), 58"(1473mm), 64"(1626mm), 70"(1778mm), 76"(1930mm), 82"(2083mm)	22"(559mm)	64"(1626mm) Table Width - 22"(559mm) Reduce Tray Width 42"(1067mm) Tray Width
	Planes - Height Adjustable Table C-Leg/Rectangle Top	29"(737mm)	58"(1473mm), 64"(1626mm), 70"(1778mm)	22"(559mm)	64"(1626mm) Table Width - 22"(559mm) Reduce Tray Width 42"(1067mm) Tray Width
	Planes LT Model Height Adjustable Table C-Leg and T-Leg/ Rectangle Top	29"(737mm)	58"(1473mm), 64"(1626mm), 70"(1778mm)	22"(559mm)	64"(1626mm) Table Width - 22"(559mm) Reduce Tray Width 42"(1067mm) Tray Width
	Masters Series Height Adjustable Table Rectangle Top	30"(762mm), 36"(914mm), 42"(1067mm)	60"(1524mm), 66"(1676mm), 72"(1829mm)	22"(559mm)	64"(1626mm) Table Width - 22"(559mm) Reduce Tray Width 42"(1067mm) Tray Width
	Masters Series Height Adjustable Table with Storage Integration Rectangle Top	30"(762mm), 36"(914mm), 42"(1067mm)	66"(1676mm), 72"(1829mm), 78"(1981mm), 84"(2134mm)	30"(762mm)	66"(1676mm) Table Width - 30"(762mm) Reduce Tray Width 36"(914mm) Tray Width
	Jive Table - Dual Disc Base Rectangle Top	30"(762mm), 36"(914mm), 42"(1067mm)	72"(1829mm), 84"(2134mm), 96"(2438mm)	36"(914mm)	72"(1829mm) Table Width - 36"(914mm) Reduce Tray Width 36"(914mm) Tray Width
	Jive Table - T-Leg - Round Column Rectangle Top	36"(914mm)	66"(1676mm), 72"(1829mm), 84"(2134mm)	12"(305mm)	66"(1676mm) Table Width - 12"(305mm) Reduce Tray Width 54"(1372mm) Tray Width
	Jive Table - T-Leg - Extruded Column Rectangle Top	30"(762mm), 36"(914mm)	54"(1372mm), 60"(1524mm), 66"(1676mm), 72"(1829mm)	18"(457mm)	60"(1524mm) Table Width - 18"(457mm) Reduce Tray Width 42"(1067mm) Tray Width
	Jive Table - C-Leg Extruded and Round Column Rectangle Top	30"(762mm)	54"(1372mm), 60"(1524mm), 66"(1676mm), 72"(1829mm)	18"(457mm)	72"(1829mm) Table Width - 18"(457mm) Reduce Tray Width 54"(1372mm) Tray Width
	Jive Table Post Round Base and Post Extruded Base Rectangle Top	30"(762mm), 36"(914mm)	42"(1067mm), 48"(1219mm), 54"(1372mm), 60"(1524mm), 66"(1676mm), 72"(1829mm), 84"(2134mm)	6"(152mm)	42"(1067mm) Table Width - 6"(152mm) Reduce Tray Width 36"(914mm) Tray Width
Adaptable Worksurface Rectangle Worksurface	30"(762mm)	42"(1067mm), 48"(1219mm), 54"(1372mm), 60"(1524mm), 72"(1829mm)	6"(152mm)	48"(1219mm) Table Width - 6"(152mm) Reduce Tray Width 42"(1067mm) Tray Width	
Cultivate Table Frames	36"(914mm), 42"(1067mm)	60"(1524mm), 72"(1829mm) Wide Frames	12"(305mm)	60"(1524mm) Table Width - 12"(305mm) Reduce Tray Width 48"(1219mm) Tray Width	
		84"(2134mm), 96"(2438mm) Wide Frames	12"(305mm)	84"(2134mm) Table Width - 12"(305mm) Reduce Tray Width 72"(1829mm) Tray Width (use two 36"(914mm) wide trays)	

Cable Management — Horizontal

Dual-Hinged Cable Management Tray — Metal

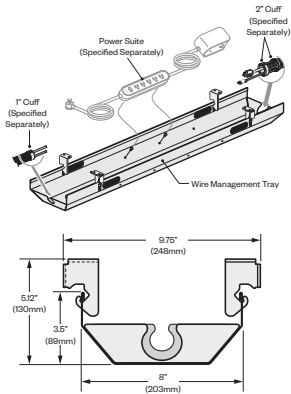

EUWT
Class YA – GSA: Open Market

Features

- Includes one metal tray and four attachment brackets with thumb tabs to assist with opening tray.
- Tray flips down to provide access to power and data cords. It can be accessed by the back or the user side.
- Belong Plug Strip can be mounted into the tray.
- Tray can accept both the 1"(25mm) and 2"(51mm) Cuffs. Reverse tray for correct opening.

Specification Tips

- Tray width must be undersized due to the understructure of the table. See Dual-Hinged Cable Management Tray — Application Chart.
- Not designed to be used on 23"(584mm)D tables or worksurfaces due to knee clearance.
- 1.5H storage placed under a fixed worksurface will not have enough clearance for a Dual-Hinged Cable Management Tray.
- Not designed for use on Flip Top Tables (Planes or Jive).
- Product is available in all standard trim colors.

To Order, Specify:

- 1) Product number.
- 2) Trim color.

Description	Number	Trim	
		A	B
22"(559mm)	EUWT-0822-P	\$ 234.13	\$250.93
30"(762mm)	EUWT-0830-P	245.73	262.53
36"(914mm)	EUWT-0836-P	254.43	271.23
42"(1067mm)	EUWT-0842-P	263.13	279.93
48"(1219mm)	EUWT-0848-P	271.83	288.63
54"(1372mm)	EUWT-0854-P	280.53	297.33
60"(1524mm)	EUWT-0860-P	289.23	306.03

Cable Management — Vertical

Cord Management Cuff

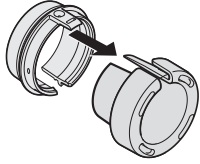

EUAC
Class YA – GSA: Open Market

Features

- Includes one bag of 26 - 2"(51mm) Cuffs or one bag of 50 - 1"(25mm) Cuffs.
- Product is applied to both ends of the separately specified Mesh Cord Manager and one end snaps into the Belong Wire Management Tray.

Specification Tips

- The size of the cuff aligns with the size of the Mesh Cord Wire Manager used.
- The Wire Management Tray can accept both the 1"(25mm) and 2"(51mm) cuff.
- Split cuff allows side insertion of cord or cable less than .5"(13mm) diameter. The shape or size of plug does not impede installation of cuff over cord cables.
- Available in charcoal TR-K only.
- Loom Insertion Tool Epart 2442-4401 is recommended for easier installation.

To Order, Specify:

- 1) Product number.
(No finish specification required.)

Description	Number	Price
1"(25mm) Bag of 50	EUAC-0001-C	\$230.34
2"(51mm) Bag of 26	EUAC-0002-C	184.27

Mesh Cord Manager with Cuffs

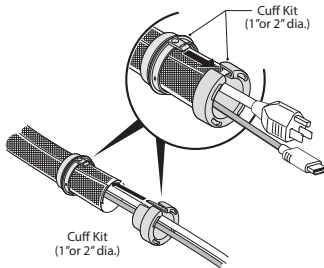

EUAW
Class YA – GSA: Open Market

Features

- Includes one bag of 26 - 2"(51mm) Cuffs or one bag of 50 - 1"(25mm) Cuffs and Cord Manager.
- Product is applied to both ends of the Mesh Cord Manager and one end snaps into the Belong Wire Management Tray.

Specification Tips

- The size of the Cuff aligns with the size of the Mesh Cord Wire Manager used.
- The Wire Management Tray can accept both the 1"(25mm) and 2"(51mm) Cuff.
- Available in grey, white or black.
- Loom Insertion Tool Epart 24424401 is recommended for easier installation.

To Order, Specify:

- 1) Product number.
(No finish specification required.)

Description	Number	Price
100'(30480mm) 1"(25mm) with 50 Cuffs	Grey	EUAW-A001-CG \$1164.86
	White	EUAW-A001-CW 1164.86
	Black	EUAW-A001-CB 1164.86
1"(25mm) with No Cuffs	Grey	EUAW-A001-NG 976.01
	White	EUAW-A001-NW 976.01
	Black	EUAW-A001-NB 976.01
50'(15240mm) 2"(51mm) with 26 Cuffs	Grey	EUAW-5002-CG \$1120.79
	White	EUAW-5002-CW 1120.79
	Black	EUAW-5002-CB 1120.79
2"(51mm) with No Cuffs	Grey	EUAW-5002-NG 976.01
	White	EUAW-5002-NW 976.01
	Black	EUAW-5002-NB 976.01

Mesh Cord Manager Bracket

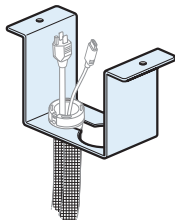

EUEA-CABR
Class YA – GSA: Open Market

Features

- Includes bracket and attachment hardware.
- Standard in black.

Specification Tips

- Designed to attach to the underside of a worksurface.
- For use with both 1"(25mm) and 2"(51mm) mesh cord manager with cuff.

To Order, Specify:

- 1) Product number.
(No finish specification required.)

Number	Price
EUEA-CABR	\$50.60

Be_Hold Modular Lower Storage Tops

Common Top

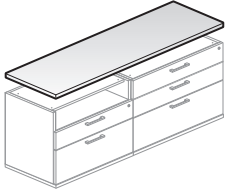

BMAL
Class BH

Features

- Includes one high-pressure laminate top (HPL) and attachment hardware.
- Top available in 0.75"(19mm) or 1.18"(30mm) thickness.
 - 0.75"(19mm) top has 1mm edges on all sides.
 - 1.18"(30mm) top has 3mm edge on front and back and 1mm edge on the sides.
- Modular lower storage units are pre-drilled to accept Common Top.

Specification Tips

- Attaches two or more same height modular lower storage units and/or a preconfigured credenza in a spanning top application.
- Creates a 2"(51mm) wireway behind 1.5H and 2H Be_Hold Modular Lower Storage; provides space to route conduit jumpers between panel mounted PDAs.

Note: Wireway area is not intended for receptacle plug-in due to limited clearance and no access. For power access use open kneespace or use 1.5H Storage for Height-Adjustable Table – Attached, specify the (Y) Power Cutout option (inset back only).

Note: Use Filler Trim to transition between storage height differences with other storage or the Power Console.
- 16"(406mm) and 24"(610mm)D common tops are for use in a single sided storage application.
- Available in two top thicknesses to accommodate specific planning models:
 - In a Compose system or Gallerie panel application the 0.75"(19mm) thick top is for use with 1.5H lower storage and the 1.18"(30mm) thick top is for use with 2H lower storage.
 - In a Be_Hold casegood application with Stack-On units or other upper storage components the 0.75"(19mm) thick top is for use with 1.5H lower storage and the 1.18"(30mm) thick top is for use with 2H lower storage.
 - In a stand alone Be_Hold casegood application the 0.75"(19mm) or 1.18"(30mm) thick top may be used with 1.5H or 2H lower storage.
- A counterweight for the lower storage unit may be required, refer to the appropriate price list page spec tips and/or the specification guide for product application information.
- If spanning an open kneespace a worksurface reinforcement bar may be required, refer to the appropriate price list page spec tips and/or the specification guide for application information.
- Field cut notch required when installing with HAT legs.
 - Requires a Tailored Solution bezel (ordered separately) covers the cut edge.

To Order, Specify:

- 1) Product number.
- 2) HPL color.
- 3) Edge color.

Be_Hold Modular Lower Storage Tops

Depth	Width	Number	HPL		
			A	B	E
0.75" (19mm) Thick — No 15" (381mm) W Pedestal					
16" (406mm)	48" (1219mm)	BMAL-1648-YYYYS-G	\$ 226.16	\$ 272.24	\$ 525.68
	54" (1372mm)	BMAL-1654-YYYYS-G	241.28	293.12	578.24
	60" (1524mm)	BMAL-1660-YYYYS-G	256.40	314.00	630.80
	66" (1676mm)	BMAL-1666-YYYYS-G	271.52	334.88	683.36
	72" (1829mm)	BMAL-1672-YYYYS-G	286.64	355.76	735.92
	78" (1981mm)	BMAL-1678-YYYYS-G	301.76	376.64	788.48
	84" (2134mm)	BMAL-1684-YYYYS-G	316.88	397.52	841.04
	90" (2286mm)	BMAL-1690-YYYYS-G	332.00	418.40	893.60
	96" (2438mm)	BMAL-1696-YYYYS-G	347.12	439.28	946.16
	102" (2591mm)	BMAL-16A2-YYYYS-G	362.24	460.16	998.72
	108" (2743mm)	BMAL-16A8-YYYYS-G	377.36	481.04	1051.28
	114" (2896mm)	BMAL-16B4-YYYYS-G	392.48	501.92	1103.84
	120" (3048mm)	BMAL-16C0-YYYYS-G	407.60	522.80	1156.40
24" (610mm)	48" (1219mm)	BMAL-2448-YYYYS-G	\$ 279.92	\$ 349.04	\$ 729.20
	54" (1372mm)	BMAL-2454-YYYYS-G	301.76	379.52	807.20
	60" (1524mm)	BMAL-2460-YYYYS-G	323.60	410.00	885.20
	66" (1676mm)	BMAL-2466-YYYYS-G	345.44	440.48	963.20
	72" (1829mm)	BMAL-2472-YYYYS-G	367.28	470.96	1041.20
	78" (1981mm)	BMAL-2478-YYYYS-G	389.12	501.44	1119.20
	84" (2134mm)	BMAL-2484-YYYYS-G	410.96	531.92	1197.20
	90" (2286mm)	BMAL-2490-YYYYS-G	432.80	562.40	1275.20
	96" (2438mm)	BMAL-2496-YYYYS-G	454.64	592.88	1353.20
	102" (2591mm)	BMAL-24A2-YYYYS-G	476.48	623.36	1431.20
	108" (2743mm)	BMAL-24A8-YYYYS-G	498.32	653.84	1509.20
	114" (2896mm)	BMAL-24B4-YYYYS-G	520.16	684.32	1587.20
	120" (3048mm)	BMAL-24C0-YYYYS-G	542.00	714.80	1665.20
0.75" (19mm) Thick — One 15" (381mm) W Pedestal					
16" (406mm)	34" (864mm)	BMAL-1634-YYYYS-G	\$ 190.88	\$ 223.52	\$ 403.04
	40" (1016mm)	BMAL-1640-YYYYS-G	206.00	244.40	455.60
	46" (1168mm)	BMAL-1646-YYYYS-G	221.12	265.28	508.16
	52" (1321mm)	BMAL-1652-YYYYS-G	236.24	286.16	560.72
	58" (1473mm)	BMAL-1658-YYYYS-G	251.36	307.04	613.28
	64" (1626mm)	BMAL-1664-YYYYS-G	266.48	327.92	665.84
	70" (1778mm)	BMAL-1670-YYYYS-G	281.60	348.80	718.40
	76" (1930mm)	BMAL-1676-YYYYS-G	296.72	369.68	770.96
	82" (2083mm)	BMAL-1682-YYYYS-G	311.84	390.56	823.52
24" (610mm)	34" (864mm)	BMAL-2434-YYYYS-G	\$ 228.96	\$ 277.92	\$ 547.20
	40" (1016mm)	BMAL-2440-YYYYS-G	250.80	308.40	625.20
	46" (1168mm)	BMAL-2446-YYYYS-G	272.64	338.88	703.20
	52" (1321mm)	BMAL-2452-YYYYS-G	294.48	369.36	781.20
	58" (1473mm)	BMAL-2458-YYYYS-G	316.32	399.84	859.20
	64" (1626mm)	BMAL-2464-YYYYS-G	338.16	430.32	937.20
	70" (1778mm)	BMAL-2470-YYYYS-G	360.00	460.80	1015.20
	76" (1930mm)	BMAL-2476-YYYYS-G	381.84	491.28	1093.20
	82" (2083mm)	BMAL-2482-YYYYS-G	403.68	521.76	1171.20

Be_Hold Modular Lower Storage Tops

Depth	Width	Number	HPL		
			A	B	E
0.75"(19mm) Thick — Two 15"(381mm)W Pedestals					
16"(406mm)	32"(813mm)	BMAL-1632-YYYYS-G	\$ 185.84	\$ 216.56	\$ 385.52
	50"(1270mm)	BMAL-1650-YYYYS-G	231.20	279.20	543.20
	56"(1422mm)	BMAL-1656-YYYYS-G	246.32	300.08	595.76
	62"(1575mm)	BMAL-1662-YYYYS-G	261.44	320.96	648.32
	68"(1727mm)	BMAL-1668-YYYYS-G	276.56	341.84	700.88
	80"(2032mm)	BMAL-1680-YYYYS-G	306.80	383.60	806.00
24"(610mm)	32"(813mm)	BMAL-2432-YYYYS-G	\$ 221.68	\$ 267.76	\$ 521.20
	50"(1270mm)	BMAL-2450-YYYYS-G	287.20	359.20	755.20
	56"(1422mm)	BMAL-2456-YYYYS-G	309.04	389.68	833.20
	62"(1575mm)	BMAL-2462-YYYYS-G	330.88	420.16	911.20
	68"(1727mm)	BMAL-2468-YYYYS-G	352.72	450.64	989.20
	80"(2032mm)	BMAL-2480-YYYYS-G	396.40	511.60	1145.20
0.75"(19mm) Thick — Three 15"(381mm)W Pedestals					
16"(406mm)	47"(1194mm)	BMAL-1647-YYYYS-G	\$ 223.64	\$ 268.76	\$ 516.92
24"(610mm)	47"(1194mm)	BMAL-2447-YYYYS-G	\$ 276.28	\$ 343.96	\$ 716.20
1.18"(30mm) Thick — No 15"(381mm)W Pedestal					
16"(406mm)	48"(1219mm)	BMBL-1648-JYJYS-G	\$ 259.30	\$ 305.38	\$ 558.82
	54"(1372mm)	BMBL-1654-JYJYS-G	276.34	328.18	613.30
	60"(1524mm)	BMBL-1660-JYJYS-G	293.38	350.98	667.78
	66"(1676mm)	BMBL-1666-JYJYS-G	310.42	373.78	722.26
	72"(1829mm)	BMBL-1672-JYJYS-G	327.46	396.58	776.74
	78"(1981mm)	BMBL-1678-JYJYS-G	344.50	419.38	831.22
	84"(2134mm)	BMBL-1684-JYJYS-G	361.54	442.18	885.70
	90"(2286mm)	BMBL-1690-JYJYS-G	378.58	464.98	940.18
	96"(2438mm)	BMBL-1696-JYJYS-G	395.62	487.78	994.66
	102"(2591mm)	BMBL-16A2-JYJYS-G	412.66	510.58	1049.14
	108"(2743mm)	BMBL-16A8-JYJYS-G	429.70	533.38	1103.62
	114"(2896mm)	BMBL-16B4-JYJYS-G	446.74	556.18	1158.10
	120"(3048mm)	BMBL-16C0-JYJYS-G	463.78	578.98	1212.58
	24"(610mm)	48"(1219mm)	BMBL-2448-JYJYS-G	\$ 320.74	\$ 389.86
54"(1372mm)		BMBL-2454-JYJYS-G	345.46	423.22	850.90
60"(1524mm)		BMBL-2460-JYJYS-G	370.18	456.58	931.78
66"(1676mm)		BMBL-2466-JYJYS-G	394.90	489.94	1012.66
72"(1829mm)		BMBL-2472-JYJYS-G	419.62	523.30	1093.54
78"(1981mm)		BMBL-2478-JYJYS-G	444.34	556.66	1174.42
84"(2134mm)		BMBL-2484-JYJYS-G	469.06	590.02	1255.30
90"(2286mm)		BMBL-2490-JYJYS-G	493.78	623.38	1336.18
96"(2438mm)		BMBL-2496-JYJYS-G	518.50	656.74	1417.06
102"(2591mm)		BMBL-24A2-JYJYS-G	543.22	690.10	1497.94
108"(2743mm)		BMBL-24A8-JYJYS-G	567.94	723.46	1578.82
114"(2896mm)		BMBL-24B4-JYJYS-G	592.66	756.82	1659.70
120"(3048mm)		BMBL-24C0-JYJYS-G	617.38	790.18	1740.58

Be_Hold Modular Lower Storage Tops

Depth	Width	Number	HPL		
			A	B	E
1.18"(30mm) Thick — One 15"(381mm)W Pedestal					
16"(406mm)	34"(864mm)	BMBL-1634-JYJYS-G	\$ 219.54	\$ 252.18	\$ 431.70
	40"(1016mm)	BMBL-1640-JYJYS-G	236.58	274.98	486.18
	46"(1168mm)	BMBL-1646-JYJYS-G	253.62	297.78	540.66
	52"(1321mm)	BMBL-1652-JYJYS-G	270.66	320.58	595.14
	58"(1473mm)	BMBL-1658-JYJYS-G	287.70	343.38	649.62
	64"(1626mm)	BMBL-1664-JYJYS-G	304.74	366.18	704.10
	70"(1778mm)	BMBL-1670-JYJYS-G	321.78	388.98	758.58
	76"(1930mm)	BMBL-1676-JYJYS-G	338.82	411.78	813.06
	82"(2083mm)	BMBL-1682-JYJYS-G	355.86	434.58	867.54
24"(610mm)	34"(864mm)	BMBL-2434-JYJYS-G	\$263.06	\$ 312.02	\$ 581.30
	40"(1016mm)	BMBL-2440-JYJYS-G	287.78	345.38	662.18
	46"(1168mm)	BMBL-2446-JYJYS-G	312.50	378.74	743.06
	52"(1321mm)	BMBL-2452-JYJYS-G	337.22	412.10	823.94
	58"(1473mm)	BMBL-2458-JYJYS-G	361.94	445.46	904.82
	64"(1626mm)	BMBL-2464-JYJYS-G	386.66	478.82	985.70
	70"(1778mm)	BMBL-2470-JYJYS-G	411.38	512.18	1066.58
	76"(1930mm)	BMBL-2476-JYJYS-G	436.10	545.54	1147.46
	82"(2083mm)	BMBL-2482-JYJYS-G	460.82	578.90	1228.34
1.18"(30mm) Thick — Two 15"(381mm)W Pedestals					
16"(406mm)	32"(813mm)	BMBL-1632-JYJYS-G	\$ 213.86	\$ 244.58	\$ 413.54
	50"(1270mm)	BMBL-1650-JYJYS-G	264.98	312.98	576.98
	56"(1422mm)	BMBL-1656-JYJYS-G	282.02	335.78	631.46
	62"(1575mm)	BMBL-1662-JYJYS-G	299.06	358.58	685.94
	68"(1727mm)	BMBL-1668-JYJYS-G	316.10	381.38	740.42
	80"(2032mm)	BMBL-1680-JYJYS-G	350.18	426.98	849.38
24"(610mm)	32"(813mm)	BMBL-2432-JYJYS-G	\$254.82	\$300.90	\$ 554.34
	50"(1270mm)	BMBL-2450-JYJYS-G	328.98	400.98	796.98
	56"(1422mm)	BMBL-2456-JYJYS-G	353.70	434.34	877.86
	62"(1575mm)	BMBL-2462-JYJYS-G	378.42	467.70	958.74
	68"(1727mm)	BMBL-2468-JYJYS-G	403.14	501.06	1039.62
	80"(2032mm)	BMBL-2480-JYJYS-G	452.58	567.78	1201.38
1.18"(30mm) Thick — Three 15"(381mm)W Pedestals					
16"(406mm)	47"(1194mm)	BMBL-1647-JYJYS-G	\$256.46	\$ 301.58	\$ 549.74
24"(610mm)	47"(1194mm)	BMBL-2447-JYJYS-G	\$ 316.62	\$384.30	\$ 756.54

Be_Hold Modular Lower Storage Tops

Pedestal Top



BMAL-YYYYS
BMBL-JYJYS
Class BH

Features

- Includes one high-pressure laminate top (HPL) and attachment hardware.
- Top available in 0.75"(19mm) or 1.18"(30mm) thickness.
 - 0.75"(19mm) top has 1mm edges on all sides.
 - 1.18"(30mm) top had 3mm edge on front and back and 1mm edge on the sides.
- Unfinished pedestal tops are pre-drilled to accept pedestal top.

Specification Tips

- For use with a Be_Hold Attached Pedestal in a stand alone application.
- Creates a 2"(51mm) wireway behind 1.5H and 2H Be_Hold Modular Lower Storage; provides space to route conduit jumpers between panel mounted PDAs.

Note: Wireway area is not intended for receptacle plug-in due to limited clearance and no access. For power access use open kneespace.

Note: Use Filler Trim to transition between storage height differences with other storage or the Power Console.
- Available in two top thicknesses to accommodate specific planning models:
 - In a Compose system application the 0.75"(19mm) thick top is for use with 1.5H lower storage and the 1.18"(30mm) thick top is for use with 2H lower storage.
 - In a Be_Hold casework application with Stack-On units or other upper storage components the 0.75"(19mm) thick top is for use with 1.5H lower storage and the 1.18"(30mm) thick top is for use with 2H lower storage.
 - In a 15"(381mm)W stand alone Be_Hold pedestal application the 0.75"(19mm) or 1.18"(30mm) thick top may be used with 1.5H or 2H lower storage.
- All 15"(381mm)W pedestals in a stand alone application require a separately specified counterweight.

To Order, Specify:

- 1) Product number.
- 2) HPL color.
- 3) Edge color.

Depth	Width	Number	HPL		
			A	B	E
0.75"(19mm) Thick					
16"(406mm)	15"(381mm)	BMAL-1615-YYYYS-G	\$143.00	\$ 157.40	\$ 236.60
18"(457mm)	12"(305mm)	BMAL-1812-YYYYS-G	\$138.80	\$ 151.76	\$ 223.04
	15"(381mm)	BMAL-1815-YYYYS-G	147.20	163.40	252.50
24"(610mm)	12"(305mm)	BMAL-2412-YYYYS-G	\$148.88	\$ 166.16	\$ 261.20
	15"(381mm)	BMAL-2415-YYYYS-G	159.80	181.40	300.20
30"(762mm)	12"(305mm)	BMAL-3012-YYYYS-G	\$158.96	\$ 180.56	\$ 299.36
	15"(381mm)	BMAL-3015-YYYYS-G	172.40	199.40	347.90
1.18"(30mm) Thick					
16"(406mm)	15"(381mm)	BMBL-1615-JYJYS-G	\$165.58	\$ 179.98	\$ 259.18
18"(457mm)	12"(305mm)	BMBL-1812-JYJYS-G	\$160.90	\$ 173.86	\$ 245.14
	15"(381mm)	BMBL-1815-JYJYS-G	170.38	186.58	275.68
24"(610mm)	12"(305mm)	BMBL-2412-JYJYS-G	\$ 172.42	\$ 189.70	\$ 284.74
	15"(381mm)	BMBL-2415-JYJYS-G	184.78	206.38	325.18
30"(762mm)	12"(305mm)	BMBL-3012-JYJYS-G	\$183.94	\$205.54	\$ 324.34
	15"(381mm)	BMBL-3015-JYJYS-G	199.18	226.18	374.68

Be_Hold Modular Lower Storage Tops

Filing and Storage Top



BMAL-YYYYS
BMBL-JYJYS
Class BH

Features

- Includes one high-pressure laminate top (HPL) and attachment hardware.
- Top available in 0.75"(19mm) or 1.18"(30mm) thickness.
 - 0.75"(19mm) top has 1mm edges on all sides.
 - 1.18"(30mm) top had 3mm edge on front and back and 1mm edge on the sides.
- Lower storage casegoods are pre-drilled to accept storage top.

Specification Tips

- Attaches to the following Be_Hold Modular Lower Storage Units: Lateral File, Hinged Door Storage and Open Cabinet.
- Creates a 2"(51mm) wireway behind 1.5H and 2H Be_Hold Modular Lower Storage; provides space to route conduit jumpers between panel mounted PDAs.
 - Note: Wireway area is not intended for receptacle plug-in due to limited clearance and no access. For power access use open kneespace.
 - Note: Use Filler Trim to transition between storage height differences with other storage or the Power Console.
- Available in two top thicknesses to accommodate specific planning models:
 - In a Compose system application the 0.75"(19mm) thick top is for use with 1.5H lower storage and the 1.18"(30mm) thick top is for use with 2H lower storage.
 - In a Be_Hold casegood application with Stack-On units or other upper storage components the 0.75"(19mm) thick top is for use with 1.5H lower storage and the 1.18"(30mm) thick top is for use with 2H lower storage.
 - In a stand alone Be_Hold casegood application the 0.75"(19mm) or 1.18"(30mm) thick top may be used with 1.5H or 2H lower storage.
- A counterweight for the lower storage unit may be required, refer to the appropriate price list page spec tips or the specification guide for product application information.
- Field cut notch required when installing with HAT legs.
 - Requires a Tailored Solution bezel (ordered separately) covers the cut edge.

To Order, Specify:

- 1) Product number.
- 2) HPL color.
- 3) Edge color.

Depth	Width	Number	HPL		
			A	B	E
0.75"(19mm) Thick					
16"(406mm)	18"(457mm)	BMAL-1618-YYYYS-G	\$ 150.56	\$ 167.84	\$ 262.88
	24"(610mm)	BMAL-1624-YYYYS-G	165.68	188.72	315.44
	30"(762mm)	BMAL-1630-YYYYS-G	180.80	209.60	368.00
	36"(914mm)	BMAL-1636-YYYYS-G	195.92	230.48	420.56
	42"(1067mm)	BMAL-1642-YYYYS-G	211.04	251.36	473.12
24"(610mm)	18"(457mm)	BMAL-2418-YYYYS-G	\$ 170.72	\$ 196.64	\$ 339.20
	24"(610mm)	BMAL-2424-YYYYS-G	192.56	227.12	417.20
	30"(762mm)	BMAL-2430-YYYYS-G	214.40	257.60	495.20
	36"(914mm)	BMAL-2436-YYYYS-G	236.24	288.08	573.20
	42"(1067mm)	BMAL-2442-YYYYS-G	258.08	318.56	651.20
1.18"(30mm) Thick					
16"(406mm)	18"(457mm)	BMBL-1618-JYJYS-G	\$ 174.10	\$ 191.38	\$ 286.42
	24"(610mm)	BMBL-1624-JYJYS-G	191.14	214.18	340.90
	30"(762mm)	BMBL-1630-JYJYS-G	208.18	236.98	395.38
	36"(914mm)	BMBL-1636-JYJYS-G	225.22	259.78	449.86
	42"(1067mm)	BMBL-1642-JYJYS-G	242.26	282.58	504.34
24"(610mm)	18"(457mm)	BMBL-2418-JYJYS-G	\$ 197.14	\$ 223.06	\$ 365.62
	24"(610mm)	BMBL-2424-JYJYS-G	221.86	256.42	446.50
	30"(762mm)	BMBL-2430-JYJYS-G	246.58	289.78	527.38
	36"(914mm)	BMBL-2436-JYJYS-G	271.30	323.14	608.26
	42"(1067mm)	BMBL-2442-JYJYS-G	296.02	356.50	689.14

Modular Lower Storage Tops

Be_Hold Be 1.5H Height Adjustable Table Storage Top - Laminate - 0.75" Thick

HAT Storage Top

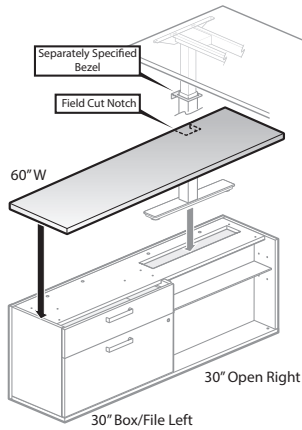

BMAL-YYYYS
CLASS BH

Features

- Includes one high-pressure laminate top (HPL) and attachment hardware.
- Top available in 0.75" (19mm) thickness with 1mm edge on all sides.
- Lower storage casegoods for HAT are predrilled to accept storage top.

Specification Tips

- Attaches to Be_Hold Be Modular Lower Storage Units for Height Adjustable Tables (HAT).
- Creates a 2" (51mm) wireway behind 1.5H and 2H Be_Hold Be Modular Lower Storage; provides space to route conduit jumpers between panel mounted PDAs.

Note: Wireway area is not intended for receptacle plug-in due to limited clearance and no access. For power access use open kneespace or use 1.5H Storage for Height-Adjustable Table, specify the (Y) Power Cutout option (inset back only).

Note: Use Filler Trim to transition between storage height differences with other storage or the Power Console.

- Designed for use with Gallerie and Compose Gallery panel (Compose Price List) applications. See Application Guide for details.
- Tops are available in a 2" (51mm) deeper size to support conduit power routing.
 - To specify the deeper top, add a "G" to the part number.
- Field cut notch required when installing with HAT legs.
 - Requires a Tailored Solution bezel (ordered separately) covers the cut edge.

To Order, Specify:

- 1) Product number.
- 2) HPL color.
- 3) Edge color.

Depth	Width	Number	HPL		
			A	B	E
16" (406mm)	30" (762mm)	BMAL-1630-YYYYS-G	\$ 180.80	\$ 209.60	\$ 368.00
	36" (914mm)	BMAL-1636-YYYYS-G	195.92	230.48	420.56
	60" (1524mm)	BMAL-1660-YYYYS-G	256.40	314.00	630.80
	66" (1676mm)	BMAL-1666-YYYYS-G	271.52	334.88	683.36
	72" (1829mm)	BMAL-1672-YYYYS-G	286.64	355.76	735.92
	78" (1981mm)	BMAL-1678-YYYYS-G	301.76	376.64	788.48
24" (610mm)	30" (762mm)	BMAL-2430-YYYYS-G	\$ 214.40	\$ 257.60	\$ 495.20
	36" (914mm)	BMAL-2436-YYYYS-G	236.24	288.08	573.20
	60" (1524mm)	BMAL-2460-YYYYS-G	323.60	410.00	885.20
	66" (1676mm)	BMAL-2466-YYYYS-G	345.44	440.48	963.20
	72" (1829mm)	BMAL-2472-YYYYS-G	367.28	470.96	1041.20
	78" (1981mm)	BMAL-2478-YYYYS-G	389.12	501.44	1119.20

Modular Lower Storage Tops

Be_Hold Be 2H Storage Tops - Laminate - 1.18" Thick

Pedestal Top

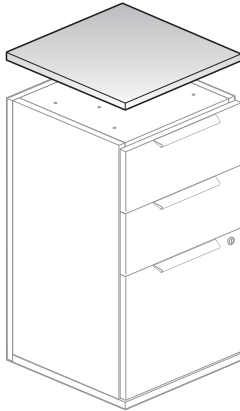

BMBL-JYJYS
Class BH

Features

- Includes one high-pressure laminate top (HPL) and attachment hardware.
- Top available in 1.18"(30mm) thickness with 3mm edge on front and back and 1mm edge on the sides.
- 2H unfinished pedestal tops are predrilled to accept pedestal top.

Specification Tips

- For use with a Be_Hold Be 2H Attached Pedestal in a stand alone application.
 - Creates a 2"(51mm) wireway behind 1.5H and 2H Be_Hold Be Modular Lower Storage; provides space to route conduit jumpers between panel mounted PDAs.
- Note: Wireway area is not intended for receptacle plug-in due to limited clearance and no access. For power access use open kneespace.
- Note: Use Filler Trim to transition between storage height differences with other storage or the Power Console.
- Designed for use with Gallerie and Compose Gallery panel (Compose Price List) applications. See Application Guide for details.

To Order, Specify:

- 1) Product number.
- 2) HPL color.
- 3) Edge color.

Depth	Width	Number	HPL		
			A	B	E
16"(406mm)	15"(381mm)	BMBL-1615-JYJYS-G	\$ 165.58	\$ 179.98	\$ 259.18
18"(457mm)	12"(305mm)	BMBL-1812-JYJYS-G	\$160.90	\$ 173.86	\$ 245.14
	15"(381mm)	BMBL-1815-JYJYS-G	170.38	186.58	275.68
24"(610mm)	12"(305mm)	BMBL-2412-JYJYS-G	\$ 172.42	\$ 189.70	\$ 284.74
	15"(381mm)	BMBL-2415-JYJYS-G	184.78	206.38	325.18
30"(762mm)	12"(305mm)	BMBL-3012-JYJYS-G	\$183.94	\$205.54	\$324.34
	15"(381mm)	BMBL-3015-JYJYS-G	199.18	226.18	374.68

Filing and Storage Top



BMBL-JYJYS
Class BH

Features

- Includes one high-pressure laminate top (HPL) and attachment hardware.
- Top available in 1.18"(30mm) thickness with 3mm edge on front and back and 1mm edge on the sides.
- 2H lower storage casegoods are predrilled to accept storage top.

Specification Tips

- Attaches to the following Be_Hold Be 2H Modular Lower Storage Units: Lateral File, Hinged Door Storage and Open Cabinet.
 - Creates a 2"(51mm) wireway behind 1.5H and 2H Be_Hold Be Modular Lower Storage; provides space to route conduit jumpers between panel mounted PDAs.
- Note: Wireway area is not intended for receptacle plug-in due to limited clearance and no access. For power access use open kneespace or use 1.5H Storage for Height-Adjustable Table - Attached, specify the (Y) Power Outout option (inset back only).
- Note: Use Filler Trim to transition between storage height differences with other storage or the Power Console.
- Designed for use with Gallerie and Compose Gallery panel (Compose Price List) applications. See Application Guide for details.

To Order, Specify:

- 1) Product number.
- 2) HPL color.
- 3) Edge color.

Depth	Width	Number	HPL		
			A	B	E
16"(406mm)	18"(457mm)	BMBL-1618-JYJYS-G	\$ 174.10	\$ 191.38	\$ 286.42
	24"(610mm)	BMBL-1624-JYJYS-G	191.14	214.18	340.90
	30"(762mm)	BMBL-1630-JYJYS-G	208.18	236.98	395.38
	36"(914mm)	BMBL-1636-JYJYS-G	225.22	259.78	449.86
	42"(1067mm)	BMBL-1642-JYJYS-G	242.26	282.58	504.34
24"(610mm)	18"(457mm)	BMBL-2418-JYJYS-G	\$ 197.14	\$223.06	\$ 365.62
	24"(610mm)	BMBL-2424-JYJYS-G	221.86	256.42	446.50
	30"(762mm)	BMBL-2430-JYJYS-G	246.58	289.78	527.38
	36"(914mm)	BMBL-2436-JYJYS-G	271.30	323.14	608.26
	42"(1067mm)	BMBL-2442-JYJYS-G	296.02	356.50	689.14

Modular Lower Storage Tops

Be_Hold Be Common Top - Laminate - 1.18" Thick

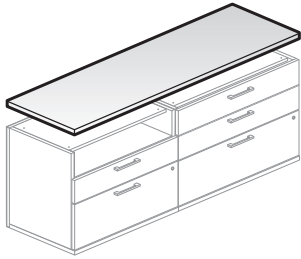

BMBL-JYJYS
Class BH

Features

- Includes one high-pressure laminate top (HPL) and attachment hardware. Top available in 1.18"(30mm) thickness with 3mm edge on front and back and 1mm edge on the sides.
- 2H modular lower storage units are predrilled to accept Common Top.

Specification Tips

- Connects two or more same-height modular lower storage units or a preconfigured credenza in a spanning top application.
- Creates a 2"(51mm) wireway behind 1.5H and 2H Be_Hold Be Modular Lower Storage; provides space to route conduit jumpers between panel mounted PDAs.

Note: Wireway area is not intended for receptacle plug-in due to limited clearance and no access. For power access use open kneespace or use 1.5H Storage for Height-Adjustable Table – Attached, specify the (Y) Power Cutout option (inset back only).

Note: Use Filler Trim to transition storage height differences with other storage or the Power Console.

- Designed for use with Gallerie and Compose Gallery panel (Compose Price List) applications. See Application Guide for details.
- Top depths:
–16"(406mm) and 24"(610mm) for single-sided storage
–32"(813mm) and 48"(1219mm) for double-sided or back-to-back storage
- If spanning an open kneespace, a worksurface reinforcement bar may be required. Refer to the Specification Guide or price list for details.
- Storage widths may not match top widths, see Product Details for actual dimensions.
- Field cut notch required when installing with HAT legs.
–Requires a Tailored Solution bezel (ordered separately) covers the cut edge.

To Order, Specify:

- 1) Product number.
- 2) HPL color.
- 3) Edge color.

Depth	Width	Number	HPL A	B	E
Application without 15"(381mm)W Pedestal					
16"(406mm)	48"(1219mm)	BMBL-1648-JYJYS-G	\$259.30	\$305.38	\$ 558.82
	54"(1372mm)	BMBL-1654-JYJYS-G	276.34	328.18	613.30
	60"(1524mm)	BMBL-1660-JYJYS-G	293.38	350.98	667.78
	66"(1676mm)	BMBL-1666-JYJYS-G	310.42	373.78	722.26
	72"(1829mm)	BMBL-1672-JYJYS-G	327.46	396.58	776.74
	78"(1981mm)	BMBL-1678-JYJYS-G	344.50	419.38	831.22
	84"(2134mm)	BMBL-1684-JYJYS-G	361.54	442.18	885.70
	90"(2286mm)	BMBL-1690-JYJYS-G	378.58	464.98	940.18
	96"(2438mm)	BMBL-1696-JYJYS-G	395.62	487.78	994.66
	102"(2591mm)	BMBL-16A2-JYJYS-G	412.66	510.58	1049.14
	108"(2743mm)	BMBL-16A8-JYJYS-G	429.70	533.38	1103.62
	114"(2896mm)	BMBL-16B4-JYJYS-G	446.74	556.18	1158.10
120"(3048mm)	BMBL-16C0-JYJYS-G	463.78	578.98	1212.58	
24"(610mm)	48"(1219mm)	BMBL-2448-JYJYS-G	\$ 320.74	\$389.86	\$ 770.02
	54"(1372mm)	BMBL-2454-JYJYS-G	345.46	423.22	850.90
	60"(1524mm)	BMBL-2460-JYJYS-G	370.18	456.58	931.78
	66"(1676mm)	BMBL-2466-JYJYS-G	394.90	489.94	1012.66
	72"(1829mm)	BMBL-2472-JYJYS-G	419.62	523.30	1093.54
	78"(1981mm)	BMBL-2478-JYJYS-G	444.34	556.66	1174.42
	84"(2134mm)	BMBL-2484-JYJYS-G	469.06	590.02	1255.30
	90"(2286mm)	BMBL-2490-JYJYS-G	493.78	623.38	1336.18
	96"(2438mm)	BMBL-2496-JYJYS-G	518.50	656.74	1417.06
	102"(2591mm)	BMBL-24A2-JYJYS-G	543.22	690.10	1497.94
	108"(2743mm)	BMBL-24A8-JYJYS-G	567.94	723.46	1578.82
	114"(2896mm)	BMBL-24B4-JYJYS-G	592.66	756.82	1659.70
120"(3048mm)	BMBL-24C0-JYJYS-G	617.38	790.18	1740.58	

Modular Lower Storage Tops

Be_Hold Be Common Top - Laminate - 1.18" Thick

Depth	Width	Number	HPL		
			A	B	E
Application with One 15"(381mm)W Pedestal					
16"(406mm)	34"(864mm)	BMBL-1634-JYJYS-G	\$ 219.54	\$ 252.18	\$ 431.70
	40"(1016mm)	BMBL-1640-JYJYS-G	236.58	274.98	486.18
	46"(1168mm)	BMBL-1646-JYJYS-G	253.62	297.78	540.66
	52"(1321mm)	BMBL-1652-JYJYS-G	270.66	320.58	595.14
	58"(1473mm)	BMBL-1658-JYJYS-G	287.70	343.38	649.62
	64"(1626mm)	BMBL-1664-JYJYS-G	304.74	366.18	704.10
	70"(1778mm)	BMBL-1670-JYJYS-G	321.78	388.98	758.58
	76"(1930mm)	BMBL-1676-JYJYS-G	338.82	411.78	813.06
	82"(2083mm)	BMBL-1682-JYJYS-G	355.86	434.58	867.54
24"(610mm)	34"(864mm)	BMBL-2434-JYJYS-G	\$263.06	\$ 312.02	\$ 581.30
	40"(1016mm)	BMBL-2440-JYJYS-G	287.78	345.38	662.18
	46"(1168mm)	BMBL-2446-JYJYS-G	312.50	378.74	743.06
	52"(1321mm)	BMBL-2452-JYJYS-G	337.22	412.10	823.94
	58"(1473mm)	BMBL-2458-JYJYS-G	361.94	445.46	904.82
	64"(1626mm)	BMBL-2464-JYJYS-G	386.66	478.82	985.70
	70"(1778mm)	BMBL-2470-JYJYS-G	411.38	512.18	1066.58
	76"(1930mm)	BMBL-2476-JYJYS-G	436.10	545.54	1147.46
	82"(2083mm)	BMBL-2482-JYJYS-G	460.82	578.90	1228.34
Application with Two 15"(381mm)W Pedestals					
16"(406mm)	32"(813mm)	BMBL-1632-JYJYS-G	\$ 213.86	\$ 244.58	\$ 413.54
	50"(1270mm)	BMBL-1650-JYJYS-G	264.98	312.98	576.98
	56"(1422mm)	BMBL-1656-JYJYS-G	282.02	335.78	631.46
	62"(1575mm)	BMBL-1662-JYJYS-G	299.06	358.58	685.94
	68"(1727mm)	BMBL-1668-JYJYS-G	316.10	381.38	740.42
	80"(2032mm)	BMBL-1680-JYJYS-G	350.18	426.98	849.38
24"(610mm)	32"(813mm)	BMBL-2432-JYJYS-G	\$254.82	\$300.90	\$ 554.34
	50"(1270mm)	BMBL-2450-JYJYS-G	328.98	400.98	796.98
	56"(1422mm)	BMBL-2456-JYJYS-G	353.70	434.34	877.86
	62"(1575mm)	BMBL-2462-JYJYS-G	378.42	467.70	958.74
	68"(1727mm)	BMBL-2468-JYJYS-G	403.14	501.06	1039.62
	80"(2032mm)	BMBL-2480-JYJYS-G	452.58	567.78	1201.38
Application with Three 15"(381mm)W Pedestals					
16"(406mm)	47"(1194mm)	BMBL-1647-JYJYS-G	\$256.46	\$ 301.58	\$ 549.74
24"(610mm)	47"(1194mm)	BMBL-2447-JYJYS-G	\$ 316.62	\$384.30	\$ 756.54

Credenza Tops

X Series Credenza Top

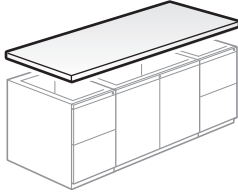

JDSL
JDSW
Class FM1

Features

- Includes high-pressure laminate (HPL) or wood top and attachment hardware.
- Top has 3mm edgeband on user and guest edge, and 1mm edgeband on sides.
- Attaches to separately specified X Series attached lateral file(s), attached storage cabinets, attached combination units, and/or attached pedestals to create a credenza.

Specification Tips

- Not for use with X Series Desk Pedestals; modesty panel mounting holes on the side of the desk pedestal will be visible.
- Creates a 2"(51mm) wireway behind X Series 1.5H and 2H storage components; provides space to route conduit jumpers between panel mounted PDAs.
Note: Wireway area is not intended for receptacle plug-in due to limited clearance and no access. For power access use open kneespace.
Note: Use Filler Trim to transition between storage height differences with other storage or the Power Console.
- If spanning an open kneespace, a worksurface reinforcement bar may be required. Refer to the Specification Guide.
- Not for use with X Series Freestanding Files, storage tops are included with freestanding casegoods.
- Designing a storage credenza with attached storage pieces less than 24"(610mm)D will result in an overhang at the back of the credenza top.
- When using attached pedestals the recommended nominal depth is 24"(610mm) to minimize overhang of the top. The actual depth of a 24"(610mm)D attached pedestal is greater than other storage pieces; the recommended application is to place the pedestal(s) at the end(s) of the credenza to conceal the depth difference. 18"(457mm) nominal depth pedestals are less deep than other storage pieces and therefore not recommended.
- For a storage credenza with attached pedestals and lateral files, specify a proud front attached lateral (not inset front) to match the pedestal front.
- When designing a credenza to support a Vertical Storage Unit, both ends of credenza must be 24"(610mm)D attached pedestals.

To Order, Specify:

- 1) Product number.
- 2) HPL or wood color for top.
- 3) Edge trim color for top (HPL only).

Width	Number	Top - HPL	
		A	B
HPL Top			
60"(1524mm)	JDSL-2660-JNNN	\$559.96	\$ 715.96
66"(1676mm)	JDSL-2666-JNNN	597.40	769.00
72"(1829mm)	JDSL-2672-JNNN	634.84	822.04
78"(1981mm)	JDSL-2678-JNNN	672.28	875.08
84"(2134mm)	JDSL-2684-JNNN	709.72	928.12

Width	Number	Top - Wood	
		A	B
Wood Top			
60"(1524mm)	JDSW-2660-KNNN	\$ 1230.76	\$1308.76
66"(1676mm)	JDSW-2666-KNNN	1335.28	1421.08
72"(1829mm)	JDSW-2672-KNNN	1439.80	1533.40
78"(1981mm)	JDSW-2678-KNNN	1544.32	1645.72
84"(2134mm)	JDSW-2684-KNNN	1648.84	1758.04

Lateral File Tops

X Series Laminate for use with Proud Style Fronts

File Top



JTPL-1830
Class FM

Features

- Includes top and attachment hardware.
- Intended for use on single files with proud style fronts.
- 1.18”(30mm) thick high-pressure laminate (HPL) top has 3mm edgeband on the front and back edges, 1mm edgeband on the sides.

Specification Tips

- Top attaches to metal file top with fasteners. Field drilling is required.
- Creates a 2”(51mm) wireway behind X Series 1.5H or 2H storage component; provides space to route conduit jumpers between panel mounted PDAs.
Note: Wireway area is not intended for receptacle plug-in due to limited clearance and no access. For power access use open kneespace.
Note: Use Filler Trim to transition between storage height differences with other storage or the Power Console.
- If spanning an open kneespace, a worksurface reinforcement bar may be required. Refer to the Specification Guide.

To Order, Specify:

- 1) Product number.
- 2) HPL color.
- 3) Edge trim color.

Depth	Width	Number	HPL		
			A	B	E
20”(508mm)	30”(762mm)	JTPL-2030-JYJYS	\$329.56	\$389.56	\$731.56
	36”(914mm)	JTPL-2036-JYJYS	358.36	430.36	840.76
	42”(1067mm)	JTPL-2042-JYJYS	387.16	471.16	949.96

Common File Top

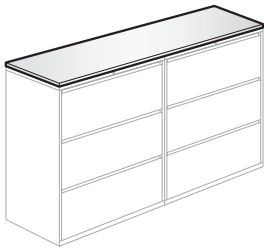

JTPL-1860
Class FM

Features

- Includes top and attachment hardware.
- Intended for use on multiple files with proud style fronts.
- 1.18”(30mm) thick high-pressure laminate (HPL) top has 3mm edgeband on the front and back edges, 1mm edgeband on the sides.

Specification Tips

- Top attaches to metal file top with fasteners. Field drilling is required.
- Creates a 2”(51mm) wireway behind X Series 1.5H or 2H storage component; provides space to route conduit jumpers between panel mounted PDAs.
Note: Wireway area is not intended for receptacle plug-in due to limited clearance and no access. For power access use open kneespace.
Note: Use Filler Trim to transition between storage height differences with other storage or the Power Console.
- If spanning an open kneespace, a worksurface reinforcement bar may be required. Refer to the Specification Guide.
- Common tops are designed to span a maximum of 3 units. If spanning more than 3 units, please contact Tailored Solutions to order the correct dimensions.

To Order, Specify:

- 1) Product number.
- 2) HPL color.
- 3) Edge trim color.

Depth	Width	Number	HPL		
			A	B	E
20”(508mm)	60”(1524mm)	JTPL-2060-JYJYS	\$503.98	\$623.98	\$1307.98
	66”(1676mm)	JTPL-2066-JYJYS	542.92	674.92	1427.32
	72”(1829mm)	JTPL-2072-JYJYS	581.86	725.86	1546.66
	78”(1981mm)	JTPL-2078-JYJYS	620.80	776.80	1666.00
	84”(2134mm)	JTPL-2084-JYJYS	659.74	827.74	1785.34
	90”(2286mm)	JTPL-2090-JYJYS	698.68	878.68	1904.68
	96”(2438mm)	JTPL-2096-JYJYS	737.62	929.62	2024.02
	102”(2591mm)	JTPL-20A2-JYJYS	776.56	980.56	2143.36
	108”(2743mm)	JTPL-20A8-JYJYS	815.50	1031.50	2262.70
	114”(2896mm)	JTPL-20B4-JYJYS	854.44	1082.44	2382.04
	120”(3048mm)	JTPL-20C0-JYJYS	893.38	1133.38	2501.38

Lateral File Tops

X Series Wood for use with Proud Style Fronts

File Top

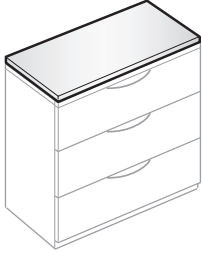

JTPW-1830
Class FM

Features

- Includes wood top and attachment hardware.
- Intended for use on single files with proud style fronts.
- 1.18"(30mm) thick wood veneer top has 3mm edgeband on the front and back edges, 1mm edgeband on the sides.

Specification Tips

- Top attaches to metal file top with fasteners. Field drilling is required.
- Creates a 2"(51mm) wireway behind X Series 1.5H or 2H storage component; provides space to route conduit jumpers between panel mounted PDAs.
Note: Wireway area is not intended for receptacle plug-in due to limited clearance and no access. For power access use open kneespace.
- Note: Use Filler Trim to transition between storage height differences with other storage or the Power Console.
- If spanning an open kneespace, a worksurface reinforcement bar may be required. Refer to the Specification Guide.

To Order, Specify:

- 1) Product number.
- 2) Wood finish color.

Depth	Width	Number	Wood	
			A	B
20"(508mm)	30"(762mm)	JTPW-2030-KXXXS	\$587.56	\$617.56
	36"(914mm)	JTPW-2036-KXXXS	667.96	703.96
	42"(1067mm)	JTPW-2042-KXXXS	748.36	790.36

Common File Top

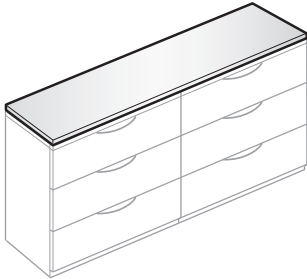

JTPW-1860
Class FM

Features

- Includes wood top and attachment hardware.
- Intended for use on multiple files with proud style fronts.
- 37.5"(953mm)D top is intended for back-to-back file applications.
- 1.18"(30mm) thick wood veneer top has 3mm edgeband on the front and back edges, 1mm edgeband on the sides.

Specification Tips

- Top attaches to metal file top with fasteners. Field drilling is required.
- Creates a 2"(51mm) wireway behind X Series 1.5H or 2H storage component; provides space to route conduit jumpers between panel mounted PDAs.
Note: Wireway area is not intended for receptacle plug-in due to limited clearance and no access. For power access use open kneespace.
- Note: Use Filler Trim to transition between storage height differences with other storage or the Power Console.
- If spanning an open kneespace, a worksurface reinforcement bar may be required. Refer to the Specification Guide.
- Common tops are designed to span a maximum of 3 units. If spanning more than 3 units, please contact Tailored Solutions to order the correct dimensions.

To Order, Specify:

- 1) Product number.
- 2) Wood finish color.

Depth	Width	Number	Wood	
			A	B
20"(508mm)	60"(1524mm)	JTPW-2060-KXXXS	\$1019.98	\$1079.98
	66"(1676mm)	JTPW-2066-KXXXS	1110.52	1176.52
	72"(1829mm)	JTPW-2072-KXXXS	1201.06	1273.06
	78"(1981mm)	JTPW-2078-KXXXS	1291.60	1369.60
	84"(2134mm)	JTPW-2084-KXXXS	1382.14	1466.14
	90"(2286mm)	JTPW-2090-KXXXS	1472.68	1562.68
	96"(2438mm)	JTPW-2096-KXXXS	1563.22	1659.22
	102"(2591mm)	JTPW-20A2-KXXXS	1653.76	1755.76
	108"(2743mm)	JTPW-20A8-KXXXS	1744.30	1852.30
	114"(2896mm)	JTPW-20B4-KXXXS	1834.84	1948.84
	120"(3048mm)	JTPW-20C0-KXXXS	1925.38	2045.38

Lateral File Tops

X Series Laminate for use with Inset Style Fronts

File Top



JTRL-1830
Class FM

Features

- Includes laminate top and attachment hardware.
- Intended for use on single files with inset style fronts.
- 1.18”(30mm) thick high-pressure laminate (HPL) top has 3mm edgeband on the front and back edges, 1mm edgeband on the sides.

Specification Tips

- Top attaches to metal file top with fasteners. Field drilling is required.
- Creates a 2”(51mm) wireway behind X Series 1.5H or 2H storage component; provides space to route conduit jumpers between panel mounted PDAs.
Note: Wireway area is not intended for receptacle plug-in due to limited clearance and no access. For power access use open kneespace.
Note: Use Filler Trim to transition between storage height differences with other storage or the Power Console.
- If spanning an open kneespace, a worksurface reinforcement bar may be required. Refer to the Specification Guide.

To Order, Specify:

- 1) Product number.
- 2) HPL color.
- 3) Edge trim color.

Depth	Width	Number	HPL		
			A	B	E
20”(508mm)	30”(762mm)	JTRL-2030-JYJYS	\$329.56	\$389.56	\$731.56
	36”(914mm)	JTRL-2036-JYJYS	358.36	430.36	840.76
	42”(1067mm)	JTRL-2042-JYJYS	387.16	471.16	949.96

Common File Top

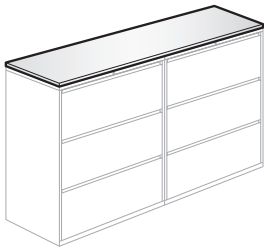

JTRL-1860
Class FM

Features

- Includes laminate top and attachment hardware.
- Intended for use on multiple files with inset style fronts.
- 36”(914mm)D top is intended for back-to-back file applications.
- 1.18”(30mm) thick high-pressure laminate (HPL) top has 3mm edgeband on the front and back edges, 1mm edgeband on the sides.

Specification Tips

- Top attaches to metal file top with fasteners. Field drilling is required.
- Creates a 2”(51mm) wireway behind X Series 1.5H or 2H storage component; provides space to route conduit jumpers between panel mounted PDAs.
Note: Wireway area is not intended for receptacle plug-in due to limited clearance and no access. For power access use open kneespace.
Note: Use Filler Trim to transition between storage height differences with other storage or the Power Console.
- If spanning an open kneespace, a worksurface reinforcement bar may be required. Refer to the Specification Guide.
- Common tops are designed to span a maximum of 3 units. If spanning more than 3 units, please contact Tailored Solutions to order the correct dimensions.

To Order, Specify:

- 1) Product number.
- 2) HPL color.
- 3) Edge trim color.

Depth	Width	Number	HPL		
			A	B	E
20”(508mm)	60”(1524mm)	JTRL-2060-JYJYS	\$503.98	\$623.98	\$1307.98
	66”(1676mm)	JTRL-2066-JYJYS	542.92	674.92	1427.32
	72”(1829mm)	JTRL-2072-JYJYS	581.86	725.86	1546.66
	78”(1981mm)	JTRL-2078-JYJYS	620.80	776.80	1666.00
	84”(2134mm)	JTRL-2084-JYJYS	659.74	827.74	1785.34
	90”(2286mm)	JTRL-2090-JYJYS	698.68	878.68	1904.68
	96”(2438mm)	JTRL-2096-JYJYS	737.62	929.62	2024.02
	102”(2591mm)	JTRL-20A2-JYJYS	776.56	980.56	2143.36
	108”(2743mm)	JTRL-20A8-JYJYS	815.50	1031.50	2262.70
	114”(2896mm)	JTRL-20B4-JYJYS	854.44	1082.44	2382.04
	120”(3048mm)	JTRL-20C0-JYJYS	893.38	1133.38	2501.38

Lateral File Tops

X Series Wood for use with Inset Style Fronts

File Top



JTRW-1830
Class FM

Features

- Includes wood top and attachment hardware.
- Intended for use on single files with inset style fronts.
- 1.18”(30mm) thick wood veneer top has 3mm edgeband on the front and back edges, 1mm edgeband on the sides.

Specification Tips

- Top attaches to metal file top with fasteners. Field drilling is required.
- Creates a 2”(51mm) wireway behind X Series 1.5H or 2H storage component; provides space to route conduit jumpers between panel mounted PDAs.
Note: Wireway area is not intended for receptacle plug-in due to limited clearance and no access. For power access use open kneespace.
Note: Use Filler Trim to transition between storage height differences with other storage or the Power Console.
- If spanning an open kneespace, a worksurface reinforcement bar may be required. Refer to the Specification Guide.

To Order, Specify:

- 1) Product number.
- 2) Wood finish color.

Depth	Width	Number	Wood	
			A	B
20”(508mm)	30”(762mm)	JTRW-2030-KXKXS	\$587.56	\$617.56
	36”(914mm)	JTRW-2036-KXKXS	667.96	703.96
	42”(1067mm)	JTRW-2042-KXKXS	748.36	790.36

Common File Top

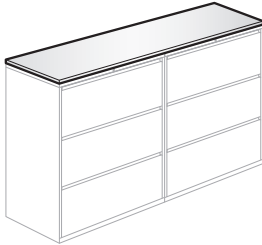

JTRW-1860
Class FM

Features

- Includes wood top and attachment hardware.
- Intended for use on multiple files with inset style fronts.
- 36”(914mm)D top is intended for back-to-back file applications.
- 1.18”(30mm) thick wood veneer top has 3mm edgeband on the front and back edges, 1mm edgeband on the sides.

Specification Tips

- Top attaches to metal file top with fasteners. Field drilling is required.
- Creates a 2”(51mm) wireway behind X Series 1.5H or 2H storage component; provides space to route conduit jumpers between panel mounted PDAs.
Note: Wireway area is not intended for receptacle plug-in due to limited clearance and no access. For power access use open kneespace.
Note: Use Filler Trim to transition between storage height differences with other storage or the Power Console.
- If spanning an open kneespace, a worksurface reinforcement bar may be required. Refer to the Specification Guide.
- Common tops are designed to span a maximum of 3 units. If spanning more than 3 units, please contact Tailored Solutions to order the correct dimensions.

To Order, Specify:

- 1) Product number.
- 2) Wood finish color.

Depth	Width	Number	Wood	
			A	B
20”(508mm)	60”(1524mm)	JTRW-2060-KXKXS	\$1019.98	\$1079.98
	66”(1676mm)	JTRW-2066-KXKXS	1110.52	1176.52
	72”(1829mm)	JTRW-2072-KXKXS	1201.06	1273.06
	78”(1981mm)	JTRW-2078-KXKXS	1291.60	1369.60
	84”(2134mm)	JTRW-2084-KXKXS	1382.14	1466.14
	90”(2286mm)	JTRW-2090-KXKXS	1472.68	1562.68
	96”(2438mm)	JTRW-2096-KXKXS	1563.22	1659.22
	102”(2591mm)	JTRW-20A2-KXKXS	1653.76	1755.76
	108”(2743mm)	JTRW-20A8-KXKXS	1744.30	1852.30
	114”(2896mm)	JTRW-20B4-KXKXS	1834.84	1948.84
	120”(3048mm)	JTRW-20C0-KXKXS	1925.38	2045.38

Haworth Gallerie Resources

Surfaces Materials

Index

Warranty/Terms of Sale

Surface Materials

Finish Color Legend

HPL

Grade A

Solid Color

H-34	Beige
H-AK	Chalk
H-8J	Charcoal
H-3J	Graphite
H-62	Gray Tone
H-WL	Linen
H-3P	Platinum
H-AA	Putty
H-3E	Smoke

Patterned

H-P1	Linen Casual
H-P2	Linen Classic
H-P3	Linen Crisp
H-P4	Linen Flax

Wood

H-B06	Brazilwood
H-E79	Colombian Walnut
H-AE	Maple
H-DYP	New Age Oak
H-E15	River Cherry
H-C09	Williamsburg Cherry

Grade B

Premium Wood Grain

H-C8	Blonde Modern Cherry
H-D1	Daintree
H-KP	Field Elm
H-KN	Grey Elm
H-KM	Landmark Wood
H-D2	Mocha Modern Cherry
H-KL	Neo Walnut
H-KR	Phantom Ecu
H-KS	Phantom Pearl
H-C9	Spiced Modern Cherry

Grade E

Premium

H-C2	Drift
H-C6	Hatch
H-C1	Hay
H-C5	Mineral
H-C4	Molasses
H-C3	Pecan
H-C7	Tanned

Edgeband

Solid Color

HP-34	Beige
HP-AK	Chalk
HP-8J	Charcoal
HP-3J	Graphite
HP-62	Gray Tone
HP-WL	Linen
HP-3P	Platinum
HP-AA	Putty
HP-3E	Smoke

Patterned Edgeband

HP-P1	Linen Casual
HP-P2	Linen Classic
HP-P3	Linen Crisp
HP-P4	Linen Flax

Wood Grain

HP-C8	Blonde Modern Cherry
HP-B06	Brazilwood
HP-E79	Colombian Walnut
HP-D1	Daintree
HP-KP	Field Elm
HP-KN	Grey Elm
HP-KM	Landmark Wood
HP-AE	Maple
HP-D2	Mocha Modern Cherry
HP-KL	Neo Walnut
HP-DYP	New Age Oak
HP-KR	Phantom Ecu
HP-KS	Phantom Pearl
HP-E15	River Cherry
HP-C9	Spiced Modern Cherry
HP-C09	Williamsburg Cherry

Ply-Edge

HP-PW	Ply-Edge
-------	----------

Premium

HP-C2	Drift
HP-C6	Hatch
HP-C1	Hay
HP-C5	Mineral
HP-C4	Molasses
HP-C3	Pecan
HP-C7	Tanned

Trim

Grade A

Smooth

TR-R	Beige
TR-AK	Chalk
TR-K	Charcoal
TR-C1	Cocoa
TR-J	Graphite
TR-G	Gray Tone
TR-AA	Putty
TR-E	Smoke
TR-PLS	Smooth Plaster
TR-FM	Snow

Textured

TR-TG	Grout
TR-TF	Pitch
TR-TW	Plaster

Grade B

Smooth

TR-IC	Accent Blue
TR-1E	Accent Orange
TR-1G	Blue Jay
TR-1R	Brownstone
TR-1N	Night
TR-1Q	Park
TR-RR	Rusty Red
TR-1M	Sable
TR-1J	Sky Blue
TR-1K	Wren

Smooth Metallic

TR-DM	Dark Bronze Metallic
TR-MC	Metallic Champagne
TR-MG	Metallic Gunmetal
TR-LE	Metallic Silver

Textured Metallic

TR-AR	Argent
TR-HE	Hellenic

Tempered

Glass

Grade A

1G-1C	Clear
-------	-------

Grade C

1G-E21	Satin Etch
--------	------------

Acrylic

Grade D

SK-1E	Frosted
-------	---------

Receptacle

TR-K	Charcoal
TR-G	Gray Tone
TR-TW	Plaster
TR-AA	Putty
TR-E	Smoke

ALERT: These materials are current, however they are being considered for future obsolescence due to low volume.

HPL	
H-AM	Amber Cherry
H-AD	Medium Cherry

Edgeband	
HP-AM	Cherry
HP-AD	Medium Cherry

Trims	
TR-1F	Accent Red
TR-CTS	Chartreuse
TR-1H	Terra

Index

Products are listed alphabetically in this index by alpha-numeric prefix/suffix codes.

Product Code	Product Description	Page
BMAL	Be_Hold Modular Lower Storage Tops — Common Top	.72
BMAL-YYYYS	Be_Hold Modular Lower Storage Tops — Filing and Storage Top	.77
BMAL-YYYYS	Be_Hold Modular Lower Storage Tops — Pedestal Top	.76
BMAL-YYYYS	Modular Lower Storage Tops — Be_Hold Be 1.5H Height Adjustable Table Storage Top - Laminate - 0.75" Thick — HAT Storage Top	.78
BMBL-JYJYS	Be_Hold Modular Lower Storage Tops — Filing and Storage Top	.77
BMBL-JYJYS	Be_Hold Modular Lower Storage Tops — Pedestal Top	.76
BMBL-JYJYS	Modular Lower Storage Tops — 2H Storage Tops - Laminate - 1.18" Thick — Filing and Storage Top	.79
BMBL-JYJYS	Modular Lower Storage Tops — Be_Hold Be 2H Storage Tops - Laminate - 1.18" Thick — Pedestal Top	.79
BMBL-JYJYS	Modular Lower Storage Tops — Be_Hold Be Common Top - Laminate - 1.18" Thick — Common Top	.80
EAEU-0000-G	Panel Accessories — Height Adjustable Table Tie	.54
EUAC	Cable Management — Vertical — Cord Management Cuff	.71
EUAK	Electrical Components — Receptacle Data Kit	.67
EUAM	Cable Management — Vertical — Conduit Clamp	.68
EUAW	Cable Management — Vertical — Gallerie Power Console Cable Chain	.68
EUAW	Cable Management — Vertical — Mesh Cord Manager with Cuffs	.71
EUEA-CABR	Cable Management — Vertical — Mesh Cord Manager Bracket	.71
EUEB-0000-9HY	Electrical Components — Concealed Base Feed Module — Hardwire Connection — Connections and Beam	.63
EUEH	Electrical Components — Infeed Module Stacking — DualCircuit — Hardwire Connection	.62
EUEP	Cable Management — Vertical — Power Break Marker	.68
EUEP	Electrical Components — Power Distribution Assembly Kit	.64
EUER-15	Electrical Components — Receptacle — 15 Amp	.66
EUEX	Electrical Components — Conduit Jumper — DualCircuit	.65
EUGK	Cable Management — Vertical — Grommets	.68
EUWT	Cable Management — Horizontal — Dual-Hinged Cable Management Tray — Metal	.70
GGCS	Power and Data Management — Access Hatch	.57
GGES	Power and Data Management — End Trim	.60
GGET	Electrical Components — Top Feed Pole for Gallerie	.62
GGFN	Power and Data Management — Laminate Front	.58
GGIV	Power and Data Management — Variable — Vertical	.61
GGIZ	Power and Data Management — Horizontal	.61
GGPS	Power and Data Management — Power Console — Core	.56
GGTS	Power and Data Management — Trough	.60
GSC Center Mount	Panel to Panel Face Attachment — C (Center Mount)	.23
GSDB	Panel to Panel Face Attachment — D (Two-Sided Half Left and Half Right Mount)	.38
GSEB (Right Face)	Panel to Panel Face Attachment — W/E (Half Left or Half Right Mount)	.20
GSFM-0000-N	Gallerie Panel Accessories — Connection Conversion Kit	.54
GSHB	Panel to Panel Face Attachment — H (Two-Sided Half Left/Right Mount)	.34
GSIN	Panel to Panel End Attachment — I (90° Face Connection)	.40
GSJBB (Right Face)	Panel to Panel Face Attachment — K/J (Left or Right Full Face Connection Mount with Half Mount)	.25
GSKBB (Left Face)	Panel to Panel Face Attachment — K/J (Left or Right Full Face Connection Mount with Half Mount)	.25
GSLB (Left Face)	Panel to Panel Face Attachment — L/R (Left or Right Mount)	.18
GSMN	Panel to Panel End Attachment — M (End Connector)	.44
GSPB	Panel to Panel Face Attachment — P (Half Left and Half Right Mount)	.28
GSRB (Right Face)	Panel to Panel Face Attachment — L/R (Left or Right Mount)	.18
GSSN	Panel to Panel End Attachment — S (Straight In-Line Add-On)	.42
GSTB	Panel to Panel Face Attachment — T (Two-Sided Left/Right Mount)	.32
GSUB	Panel to Panel Face Attachment — U (Left and Right Mounts)	.30
GSWB (Left Face)	Panel to Panel Face Attachment — W/E (Half Left or Half Right Mount)	.20
GSXB	Panel to Panel Face Attachment — X (Two-Sided Center Mount)	.36
JDSL	Credenza Tops — X Series Credenza Top	.82

Index

<u>Product Code</u>	<u>Product Description</u>	<u>Page</u>
JDSW	Credenza Tops — X Series Credenza Top82
JTPL-1830	Lateral File Tops — X Series Laminate for use with Proud Style Fronts — File Top83
JTPL-1860	Lateral File Tops — Laminate for use with Proud Style Fronts — Common File Top83
JTPW-1830	Lateral File Tops — X Series Wood for use with Proud Style Fronts — File Top84
JTPW-1860	Lateral File Tops — Wood for use with Proud Style Fronts — Common File Top84
JTRL-1830	Lateral File Tops — X Series Laminate for use with Inset Style Fronts — File Top85
JTRL-1860	Lateral File Tops — Laminate for use with Inset Style Fronts — Common File Top85
JTRW-1830	Lateral File Tops — X Series Wood for use with Inset Style Fronts — File Top86
JTRW-1860	Lateral File Tops — Wood for use with Inset Style Fronts — Common File Top86
SYGF-0000-4	Gallerie Panel Accessories — Glass Channel Filler54
SYGG	Panel Accessories — Insert Glass — Panel Glass Ready Option51
SYWB	Panel Accessories — Panel Hanging Brackets53
VZAR-0000-9	Electrical Components — Receptacle and Data Blank Cover (DualCircuit)67
VZEB-0000-19	Electrical Components — Single Circuit Base Feed Module — Receptacle Connection with Power Cord (Canada Only)63
VZEB-0000-29	Electrical Components — Single Circuit Base Feed Module — Receptacle Connection with Power Cord (USA Only)63
VZEF	Electrical Components — Flexible Power Connector — DualCircuit65
VZSG	Panel Accessories — Glass Topper — Panel Mounting48
VZST	Panel Accessories — Topper Holder Kit50
ZBBP-0000-PN	Gallerie Panel Accessories — Tie Plate47
ZUBW-0000-CN	Panel Accessories — Panel Attachment Bracket47
ZUBW-0000-PN	Panel Accessories — Panel Attachment Bracket47
ZYFS	Worksurface Support — Worksurface Support Panel46

Product Compatibility and Limited Warranty Policy

Great Expectations

You have them as a Haworth customer and so do we. And because we value our customers, we cover our products with the Haworth North America Product Compatibility and Limited Warranty Policy.

Our Commitment To Product Compatibility – Integrated Product Platforms

As a market leader in the design and manufacture of workspaces that adapt to change, we strive to maintain product compatibility within our various generations of integrated product platforms. This benefits the customer who desires to update or modify their work environment. It also benefits the customer needing to replace a product due to damage or other reasons but which is no longer manufactured or is otherwise unavailable, such as a fabric or finish that is discontinued because of changing market preferences. In both circumstances, we often can provide products with comparable function and performance.

Our Commitment To Product Quality – The Haworth North America Limited Warranty

To ensure customer satisfaction and peace of mind, we stand behind our products with the Haworth North America Limited Warranty. To review the current version of the limited warranty including its terms and conditions, please go to:

www.haworth.com/warranty or contact OneTouch@Haworth.com or 1 877 429 6784.

Warranty Requests or Questions

For questions or service requests pertaining to the Haworth Limited Warranty, please contact your Haworth dealer.

If you are unsure who your dealer is, please contact **OneTouch@Haworth.com or 1 877 429 6784.**

Terms of Sale

The Terms of Sale apply to all products in the North America Price Lists. To review the current version of the North American Terms of Sale, please go to:

www.haworth.com/terms-of-sale or contact OneTouch@Haworth.com or 1 877 429 6784.

HAWORTH

HAWORTH® is a registered trademark of Haworth, Inc.

© Haworth, Inc. All rights reserved. 2026 2.26

haworth.com | 800 344 2600