

5 2 ↑ ↓

HAWORTH

# Seating

North America Price List – December 2025



# Electronic Update Page – Seating Price List

- The table below lists all of the updates and addendums added to this price list since the original version was created.
- All **Update** pages will replace the existing pages within the document.
- All **New** pages will be placed at the back of the document.

Link	Date	Pages	Description
<a href="#">Click Here</a>	February 2026	106-107	<b>Update</b> – Correction to Snow upcharge.
<a href="#">Click Here</a>	February 2026	171	<b>Update</b> – Openest was updated to remove Stormy and Vapor painted MDF..
<a href="#">Click Here</a>	February 2026	191-193	<b>Update</b> – Finish Pages were updated to clarify and add consistency to the task seating finishes and remove Stormy and Vapor from Openest..



**This Haworth North American price book contains US list prices.**

Canadian customers can convert the US list price into their Canadian equivalent by going to [www.Haworth.com/Canada](http://www.Haworth.com/Canada) to find the current Canadian multipliers. These multiplier factors allow you to convert the US list price into a Canadian list price.

# Haworth Price List Overview

## Tips for Using Haworth Price Lists

The following overview explains how information is organized within the Seating price list (Includes: Fern®, Zody® II, Zody® LX, Zody®, Very®, Soji®, Breck™, Veda™ Improv®, X-99®, Maari®, Candor®, Composites™, Resonate™, Riverbend™, Pebble®, Openest™, Poppy™, Wyn™, HarborWork Lounge®, Hello®, To Do® and Tilt™).

### Navigation Links

Use the links to jump back and forth to relevant pages.

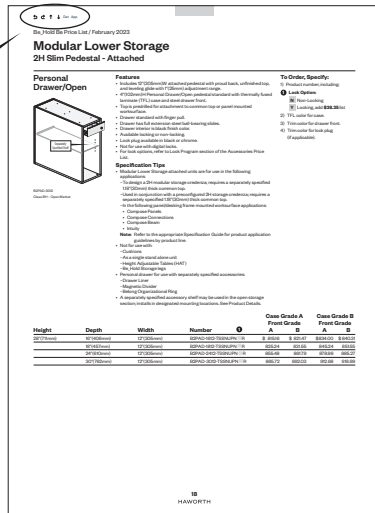
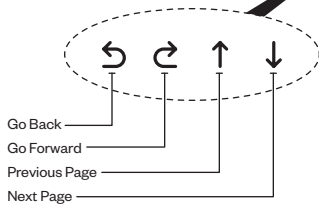

## Haworth Price Books are organized into the following sections:

### Price List Section

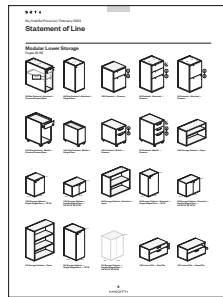

**Statement of Line**  
Provides a visual overview of the product offering.

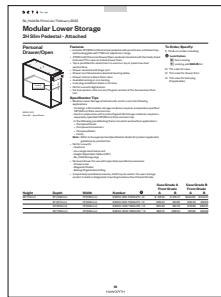

**Price List**  
Includes product features, specification tips, catalog numbers and list pricing.

### Resources Section

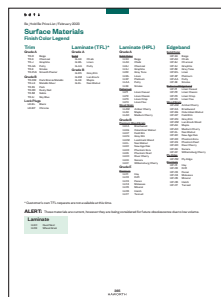

**Finishes and Fabrics**  
Lists available product finishes and fabrics.

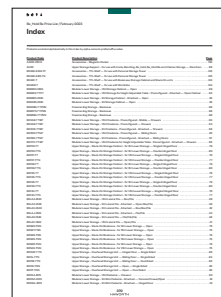

**Index**  
Lists products alphabetically by catalog number.



**Warranty and Terms of Sale**  
Provides warranty information and general terms.



**This Page Intentionally Left Blank**

# Haworth Seating Price List

Includes pricing, catalog numbers, finish codes/availability, specification requirements, line art, dimensions, and specification tips for Haworth Seating.

**Fern**

**Zody II**

**Zody LX**

**Zody**

**Very**

**Soji**

**Breck**

**Veda**

**Improv**

**X99**

**Maari**

**Candor**

**Composites**

**Resonate**

**Riverbend**

**Pebble**

**Openest**

**Poppy**

**Wyn**

**Cardigan Lounge**

**Hello**

**To Do**

**Tilt**

# Table of Contents

## Price List

<b>Statement of Line</b> .....	8	Accessories — Chair-to-Chair .....	118
<b>Fern</b>		Tandem Seating .....	119
At-A-Glance .....	15	<b>X99</b>	
Task Chair .....	20	At-A-Glance .....	120
Task Stool .....	22	Seminar Chair .....	122
<b>Zody II</b>		Advanced Seminar Chair .....	123
At-A-Glance .....	24	<b>Maari</b>	
Task Chair .....	31	At-A-Glance .....	124
Task Stool .....	34	Sled Base Chair .....	126
Dual Posture .....	36	Four-Leg Chair .....	127
<b>Zody LX</b>		Wood-Leg Chair .....	128
At-A-Glance .....	38	Four-Star Base Chair .....	129
Task Chair .....	44	Five-Star Base Chair .....	130
Task Stool .....	46	Sled Base Stool — Standard Back .....	132
Dual Posture .....	48	Sled Base Stool — Low Back .....	133
<b>Zody</b>		Four-Leg Stool .....	134
At-A-Glance .....	50	Wood-Leg Stool — Standard Back .....	135
Task Chair .....	56	Wood-Leg Stool — Low Back .....	136
Task Stool .....	58	<b>Candor</b>	
Sled Base .....	60	Guest/Occasional Seating — Fully Upholstered Seat and Back .....	137
4 Leg .....	61	Guest/Occasional Seating — Fully Upholstered Seat and 1/2 Back .....	137
<b>Very Task</b>		<b>Composites</b>	
At-A-Glance .....	62	Guest/Occasional Seating — Arc Arm, Upholstered Back .....	138
Task Chair .....	68	Guest/Occasional Seating — Stool, Armless, Upholstered Back .....	138
Task Stool .....	70	<b>Resonate</b>	
<b>Very Wire Stacker</b>		At-A-Glance .....	139
At-A-Glance .....	72	Modular Lounge — Corner — Left/Right Hand .....	143
Wire Stacker .....	73	Modular Lounge — Straight Back — Back/No Arms .....	144
Bar Height Wire Stool .....	74	Modular Lounge — Ottoman .....	145
Counter Height Wire Stool .....	75	Modular Lounge — Table .....	146
<b>Very Perforated Side, Seminar and Side Stool</b>		Modular Lounge — Alignment Clip .....	147
At-A-Glance .....	76	Side Chair .....	148
Side Chair — Perforated Back .....	77	Lounge Chair .....	149
Side Chair with Tablet Arm — Perforated Back .....	78	<b>Riverbend and Pebble</b>	
Side Chair with Storage Rack — Perforated Back .....	79	At-A-Glance .....	150
Bar Height Side Stool — Perforated Back .....	80	<b>Riverbend</b>	
Counter Height Side Stool — Perforated Back .....	81	Straight — Single Seat .....	156
Seminar Chair — Perforated Back .....	82	Straight — Double Seat .....	157
Seminar with Storage Rack — Perforated Back .....	83	Straight — Triple Seat .....	158
<b>Very Perforated Conference Chair and Conference Stool</b>		Curved — Concave — 90° Concave .....	159
At-A-Glance .....	84	Curved — Concave — 60° Concave .....	160
Conference Chair — Perforated Back .....	85	Curved — Convex — 60° Convex .....	161
Conference Stool — Perforated Back .....	87	Corner — Square .....	162
Accessories — Ganging Connector .....	88	<b>Pebble</b>	
Accessories — Stacking Carts .....	88	Ottoman .....	163
<b>Soji</b>		<b>Riverbend Accessories</b>	
At-A-Glance .....	89	Ganging Bracket .....	164
Task Chair .....	95	<b>Riverbend Power Module</b>	
Soji XL — Task Chair .....	97	Corded .....	165
<b>Soji</b>		Hardwire .....	165
Task Stool .....	99	<b>Openest</b>	
<b>Breck</b>		Plume Screens — Plume 3 .....	166
At-A-Glance .....	101	Plume Screens — Plume 6 .....	166
Task Chair .....	106	Plume Screens — Plume 9 .....	166
Stool .....	107	Feather Sofa — Feather — Symmetrical .....	167
<b>Veda</b>		Feather Sofa — Feather — Asymmetrical .....	167
At-A-Glance .....	108	Chick Pouf — Chick Pouf with Back .....	168
Mid-Back Chair — Standard Tilt .....	110	Chick Pouf — Chick Pouf without Back .....	168
Mid-Back Chair — Synchronized Tilt .....	110	Chick Pouf — Large Square — No Back .....	169
High-Back Chair — Synchronized Tilt .....	111	Chick Pouf — Rectangle — No Back .....	169
<b>Improv</b>		Chick Pouf — Round — No Back .....	170
At-A-Glance .....	112	Sprig Tables — Rectangle .....	171
Leg-Base Stacking Chairs .....	115	Sprig Tables — Round .....	171
Sled-Base Chairs — Non-Stacking .....	116		
Stools .....	117		
Accessories — Stacking Dolly .....	118		

# Table of Contents

---

## Poppy

At-A-Glance .....	172
Guest — Four Star Base with Glides .....	173
Guest — Five Star Base with Casters .....	174
Guest — Sled Base .....	175
Guest — Wood Base .....	175
Lounge — Basket .....	176
Lounge — Swivel .....	176

## Wyn

At-A-Glance .....	177
Lounge Chair .....	179

## Cardigan Lounge

Chair .....	182
Pillow .....	182

## Hello

At-A-Glance .....	183
Lounge Chair .....	184
Pouf .....	187

## ToDo

Upholstered Chair .....	188
-------------------------	-----

## Tilt

Stool .....	189
-------------	-----

## Resources

### Surface Materials

Finish Color Legend .....	191
Fabrics/Color Legend .....	194

<b>Index</b> .....	195-199
--------------------	---------

<b>Lifetime Product Warranty</b> .....	Inside Back Cover
--	-------------------

# Statement of Line

## Fern

Pages 20-23



Task Chair



Task Chair



Task Chair



Task Chair



Task Stool



Task Stool



Task Stool



Task Stool

## Zody II

Pages 31-37



Task Chair



Task Chair



Task Chair



Task Chair



Task Stool



Task Stool



Task Stool



Task Stool



Dual Posture



Dual Posture



Dual Posture

## Zody LX

Pages 44-49



Task Chair



Task Chair



Task Chair



Task Chair



Task Stool



Task Stool



Task Stool



Task Stool



Dual Posture



Dual Posture



Dual Posture

# Statement of Line

## Zody

Pages 56-61



Task Chair



Task Chair



Task Chair



Task Stool



Task Stool



Task Stool



Sled Base



4 Leg

## Very

Pages 68-87



Task Chair



Task Chair



Task Chair



Task Chair



Task Stool



Task Stool



Task Stool



Task Stool



Wire Stacker



Wire Stacker



Bar Height Wire Stool



Bar Height Wire Stool



Counter Height Wire Stool



Counter Height Wire Stool



Side Chair Perforated Back



Side Chair Perforated Back



Side Chair with Tablet Arm Perforated Back



Side Chair with Storage Rack Perforated Back



Bar Height Side Stool Perforated Back



Bar Height Side Stool Perforated Back



Seminar Chair Perforated Back



Seminar Chair Perforated Back



Seminar with Storage Rack Perforated Back



Seminar with Storage Rack Perforated Back



Conference Chair Perforated Back



Conference Chair Perforated Back



Conference Stool Perforated Back



Conference Stool Perforated Back

# Statement of Line

## Very Accessories

Page 88

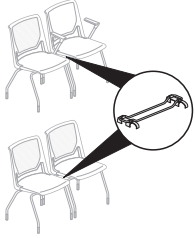

Ganging Connector

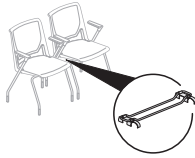

Ganging Connector

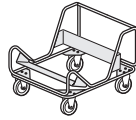

Stacking Cart



Stacking Cart

## Soji

Pages 95-100



Task Chair



Task Chair



Task Chair



Task Chair



Soji XL  
Task Chair



Task Stool



Task Stool



Task Stool



Task Stool

## Breck

Pages 106-107



Task Chair



Stool

## Veda

Pages 110-111



Mid-Back Chair  
Standard Tilt



Mid-Back Chair  
Synchronized Tilt



High-Back Chair  
Synchronized Tilt

# Statement of Line

## Improv

Pages 115-118



Leg-Base Stacking Chair



Leg-Base Stacking Chair



Sled-Base Chair Non-Stacking



Sled-Base Chair Non-Stacking



Stool



Stool



Stool



Stool



Stacking Dolly



Chair-to-Chair Connecting Bars

## X99

Pages 122-123



Seminar Chair



Seminar Chair



Advanced Seminar Chair



Advanced Seminar Chair

## Maari

Pages 126-136



Sled Base Chair



Sled Base Chair



Sled Base Chair



Four-Leg Chair



Four-Leg Chair



Four-Leg Chair



Wood-Leg Chair



Wood-Leg Chair



Wood-Leg Chair



Four-Star Base Chair



Four-Star Base Chair



Four-Star Base Chair



Five-Star Base Chair



Five-Star Base Chair



Five-Star Base Chair



Sled Base Stool Standard Back



Sled Base Stool Standard Back



Sled Base Stool Standard Back



Sled Base Stool Low Back



Four-Leg Stool



Four-Leg Stool



Four-Leg Stool



Wood-Leg Stool Standard Back



Wood-Leg Stool Standard Back



Wood-Leg Stool Standard Back



Wood-Leg Stool Low Back

# Statement of Line

## Candor

Pages 137-138



Guest Occasional Seating  
Fully Upholstered Seat  
and Back



Guest Occasional Seating  
Fully Upholstered Seat  
and 1/2 Back



Guest Occasional Seating  
Arc Arm  
Upholstered Back



Guest Occasional Seating  
Stool, Armless  
Upholstered Back

## Resonate

Pages 143-149

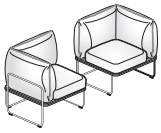

Modular Lounge  
Corner  
Left/Right Hand



Modular Lounge  
Straight Back  
Back/No Arms



Modular Lounge  
Ottoman



Modular Lounge  
Table

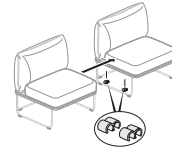

Modular Lounge  
Alignment Clip



Side Chair



Side Chair



Lounge Chair



Lounge Chair

## Riverbend

Pages 156-162

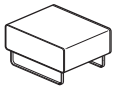

Straight  
Single Seat

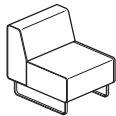

Straight  
Single Seat

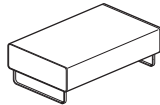

Straight  
Double Seat

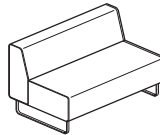

Straight  
Double Seat

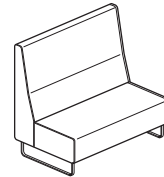

Straight  
Double Seat

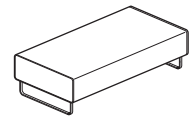

Straight  
Triple Seat

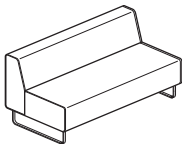

Straight  
Triple Seat

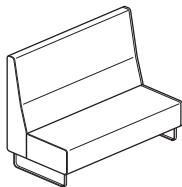

Straight  
Triple Seat

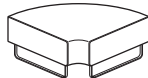

Curved - Concave  
90° Concave

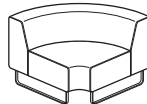

Curved - Concave  
90° Concave

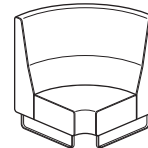

Curved - Concave  
90° Concave

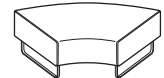

Curved - Concave  
60° Concave

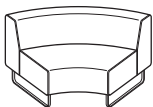

Curved - Concave  
60° Concave

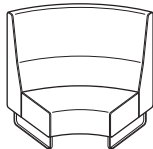

Curved - Concave  
60° Concave



Curved - Convex  
60° Convex

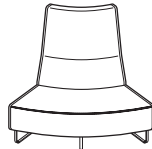

Curved - Convex  
60° Convex

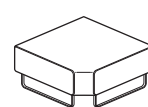

Corner - Square

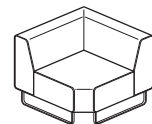

Corner - Square

# Statement of Line

## Pebble

Page 163



Ottoman



Ottoman



Ottoman

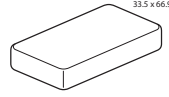

Ottoman

## Riverbend Accessories

Page 164

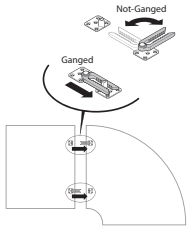

Ganging Bracket

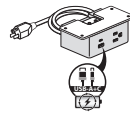

Corded

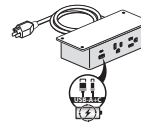

Corded

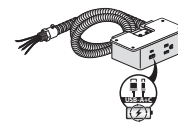

Hardwire

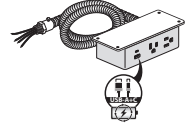

Hardwire

## Riverbend Power Module

Page 165

## Openest

Page 166-171

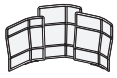

Plume 3 Screen

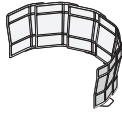

Plume 6 Screen

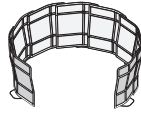

Plume 9 Screen

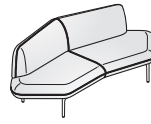

Feather Sofa  
Symmetrical

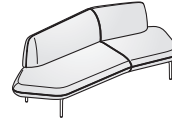

Feather Sofa  
Asymmetrical

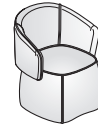

Chick Pouf  
with Back



Chick Pouf  
without Back

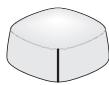

Chick Pouf  
Large Square  
No Back

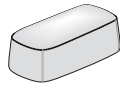

Chick Pouf  
Rectangle  
No Back

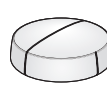

Chick Pouf  
Round  
No Back

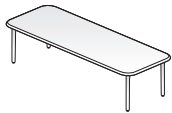

Sprig Tables  
Rectangle



Sprig Tables  
Round



Sprig Tables

## Poppy

Pages 173-176



Guest  
Four Star Base  
with Glides



Guest  
Five Star Base  
with Casters



Guest  
Tablet  
Five Star Base  
with Casters



Guest  
Sled Base



Guest  
Wood Base



Lounge  
Basket



Lounge  
Swivel

# Statement of Line

## Wyn

Page 179



Lounge Chair

## Cardigan Lounge

Page 182



Chair



Pillow

## Hello

Pages 184-187

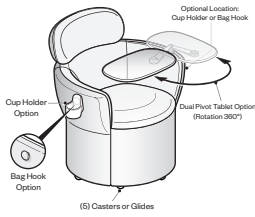

Lounge Chair

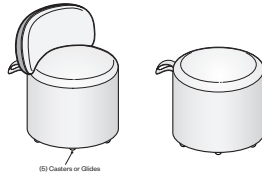

Pouf

## ToDo

Page 188



Stationary Fully Upholstered



Mobile Fully Upholstered

## Tilt

Page 189



Stool

# Fern

## At-A-Glance

---

<b>Designer</b>	Haworth Design Studio, through collaboration with ITO Design.
-----------------	---

---

<b>Fern</b>	A revolutionary chair, backed by 16 patents and on-going research that blends science-based wellness and comfort with sustainability and international design.
-------------	--

---

<b>Awards</b>	2016 Best of Year award for Task Seating from Interior Design 2017 Red Dot award: Product Design
---------------	---

---

<b>Environmental Factors</b>	Refer to Product Environmental Data sheet (PED) for recycled content and certifications. Take Back Program - can be easily disassembled at the end of its useful life. Manufactured in a zero landfill, ISO 14001 certified facility in Bruce, MS, USA.
------------------------------	---

---

<b>Finishes and Fabrics</b>	A complete listing of finishes and fabrics for Fern seating is available in the back of the price list.
-----------------------------	---

---

<b>COM &amp; COL General Information</b>	<p>To order a COM fabric (Customer's Own Material) contact the Haworth Inquiry Center (1.800.462.8562), your local Haworth dealer, or go to <a href="http://Surfaces.haworth.com">Surfaces.haworth.com</a> to find out if the COM you have selected has already been tested and approved. The surface collection site also has information on the Haworth alliance program with Carnegie, Luna Textiles, and Maharam as well as our industry-leading Pre-Approved COM program.</p> <p>COM fabrics are placed into Grades based on the cost per linear yard. If a fabric's cost exceeds the range of our highest Grade it will be noted as Non-Graded. The product will be priced at Grade A; the COM fabric costs will appear as a separate line item. The fabric charge will be Haworth's purchase cost plus a 4% administrative fee (based on the cost of the fabric). Yardage calculations will include any applicable fabric repeat.</p> <p>COM Leather products will be priced at a leather Grade A; COL costs will appear as a separate line item. The leather costs will be Haworth's purchase cost plus a 4% administrative fee (based on the cost of the leather).</p>
--	---

---

<b>Stain Repellent</b>	Stain Repellent or Stain Repellent with Moisture Barrier available on fabric surfaces only. Stain Repellent only: To specify add " <b>P</b> " to the end of the product number. Example: SFT-U0-7S02A1 <b>P</b> Stain Repellent with Moisture Barrier: To specify add " <b>D</b> " to the end of the product number. Example: SFT-U0-7S02A1 <b>D</b>
------------------------	--

---

<b>Shipping Weights/Cube (Including packaging)</b>	<ul style="list-style-type: none"><li>• Task Chair<ul style="list-style-type: none"><li>-With arms - 57 lbs. / 19.14 cubic feet</li><li>-Armless - 53 lbs. / 19.14 cubic feet</li></ul></li><li>• Task Stool<ul style="list-style-type: none"><li>-With arms - 61 lbs. / 22.1 cubic feet</li><li>-Armless - 57 lbs. / 22.1 cubic feet</li></ul></li></ul>
--	---

---

<b>Specifications</b>	Task chairs are designed for use by individuals up to 350lbs.* Task stools are designed for use by individuals up to 325lbs.  * Task chairs with forward tilt are designed for use by individuals up to 325lbs.
-----------------------	--

# Fern

## At-A-Glance

### Catalog Logic

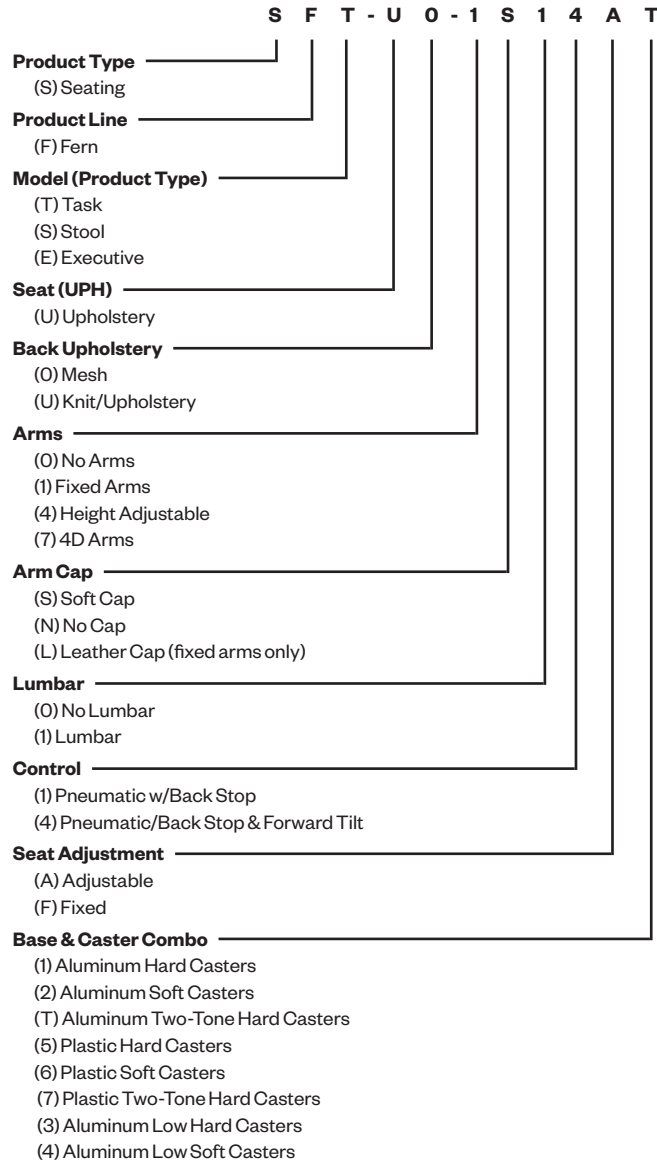

# Fern

## At-A-Glance — Standard Mobility and Adjustability

### Seat Height Adjustment

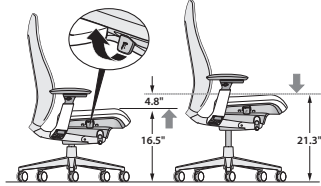

#### Features

- Pneumatic seat height adjustment.
- Seat height adjusts 5" (127mm) from 16.5" (419mm) to 21.5" (546mm) in standard models. Low-position adjusts from 15" (381mm) to 17.5" (445mm).

#### Benefits

- Ensures the comfort of the lower limbs by avoiding pressure on the underside of the thigh caused by a seat pan that is too high, or decreased thigh-to-torso angle if the seat is too low.
- Accommodates users between approximately 4'11" (1499mm) and 6'3" (1905mm) tall to provide good leg circulation.
- Seat height adjustment is important in setting the proper hand position and allowing for proper sitting eye height as well.

### Seat Depth Adjustment



#### Feature

- Optional seat depth has 3" (76mm) seat depth range. Fixed seat also available.

#### Benefit

- Supports the thighs, allows users to rest against the seat back for back support, and avoids pressure on the back of the knees of small to tall users.

### Balanced 3-Point Tilt

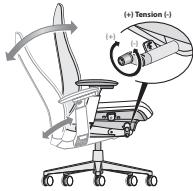

#### Features

- Balanced 3-point tilt mechanism.
- Back reclines 24° from the upright position.
- Seat pan moves downward 5° from the initial position.

#### Benefits

- Comfortable relaxed posture.
- Recline allows for the opening of the user's chest cavity providing good airflow to promote alertness.
- Users' feet remain flat on the floor.

### Tilt Tension Control

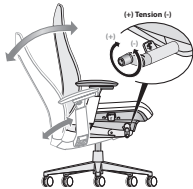

#### Feature

- Regulates the amount of resistance felt when leaning back in the chair and the effort required to recline the chair backwards.

#### Benefit

- Personalized support to accommodate users of different body types and different work styles.

### Edgeless Back Design

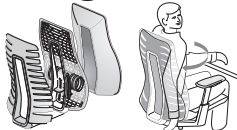

#### Features

- Edgeless design provides flexibility.
- Patented design with flexible fronds and cradle system provide total back support.

#### Benefit

- Encourages movement, eliminates pressure point from hard edge.

### Back Support/ Lumbar Adjustment

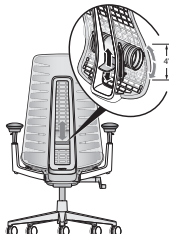

#### Features

- Total back support, providing pelvic, to lumbar to thoracic support (upper back).
- Optional height adjustable lumbar.
- Range of 4" (102mm) of height adjustment.

#### Benefits

- Provides additional support in the lower back.
- Lumbar adjustment maintains the natural curvature of the spine at the lower back and allows users to choose the support that feels right for them.
- Integrated passive pelvic support rotates the pelvis forward to maintain the natural spine shape.

# Fern

## At-A-Glance — Standard Mobility and Adjustability

### Back Stop



#### Feature

- Back Stop stops in 5 positions - upright and every 7° of back angle.

#### Benefit

- Allows users the choice of selecting an upright position or limiting the amount of recline while performing different tasks.

### Forward Tilt



#### Feature

- Optional forward tilt allows seat pan to move downward 5° from the initial position.

#### Benefit

- Allows user the opportunity to vary their posture throughout the day.

### 4D Arm

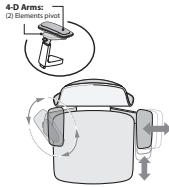

#### Features

- Optional 4D arm adjusts in 4 ways:
  - Height adjustment 4.8”(122mm)
  - Side-to-side arm cap adjustment range: 15”(381mm) [7.5”(191mm) each arm cap]
  - Front-to-back adjustment range: 3.5”(89mm)
  - Pivoting 40° in and 40° out

#### Benefits

- Height adjustment offers users varying elbow rest heights so that users avoid lifting their shoulders or leaning sideways to get arm support.
- Front-to-back adjustment adjusts the armrest length, which is important because it allows users to get close to the work surface while maintaining the effective use of the backrest.
- Side-to-side adjustment ensures a comfortable resting position for the arms with proper support of the forearm while allowing for easy entry/exit of the chair.
- Pivoting provides proper support of the forearm when performing tasks involving keying and mousing.

### Height Adjustable Arm



#### Feature

- Optional height adjustable arms adjust 4.8”(122mm) vertically.

#### Benefit

- Height adjustment accommodates users with varying elbow rest heights so that users avoid lifting their shoulders or leaning sideways to get arm support.

### Base

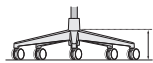

Standard Plastic Base

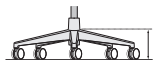

Optional Aluminum Base

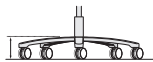

Low Position Base  
(Aluminum only)

#### Colors

Fog, Black

#### Casters

Hard: Black or two-tone grey  
Soft: Black

#### Colors

Painted Light Bronze, Metallic Silver, Metallic Champagne, Pitch (textured black), Snowfall or Polished Aluminum

#### Casters

Hard: Black or two-tone grey  
Soft: Black

#### Colors

Painted Light Bronze, Metallic Silver, Metallic Champagne, Pitch (textured black) or Snowfall

#### Casters

Hard: Black or two-tone grey  
Soft: Black

# Fern

## At-A-Glance — Upholstery/Aesthetic Options

### Fern Plastic Model

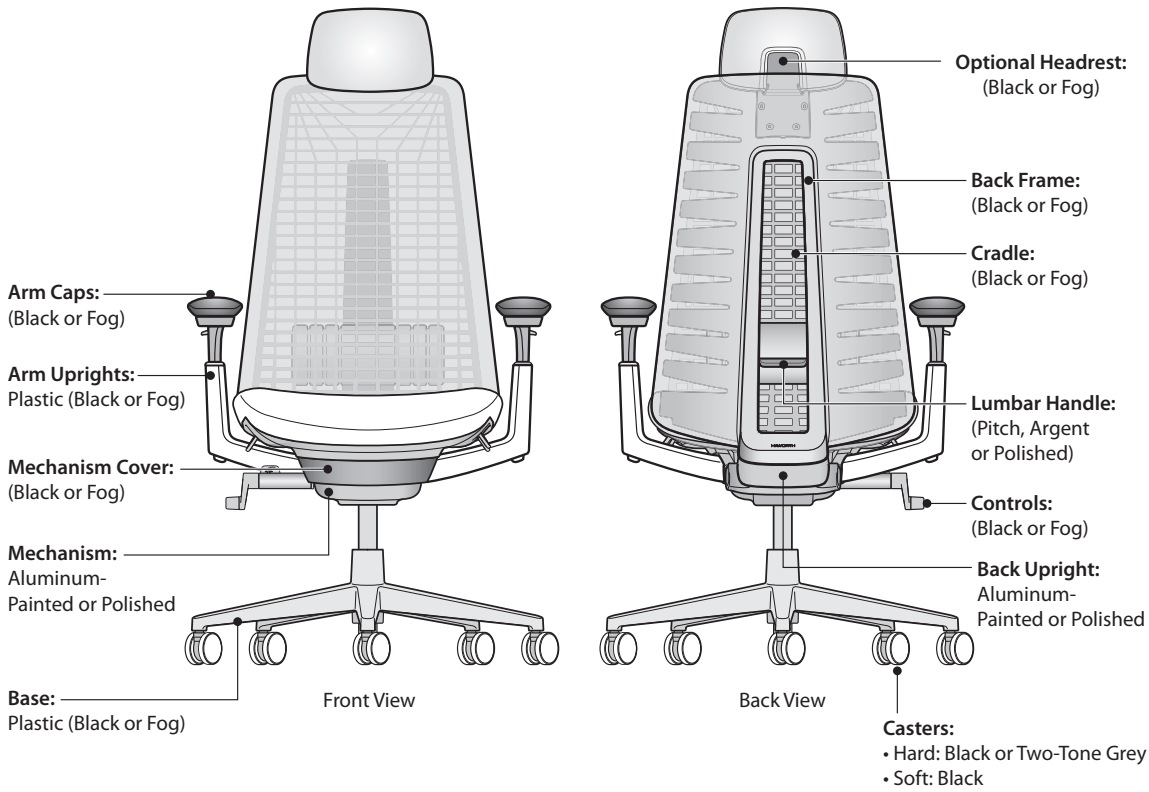

### Fern Aluminum Model

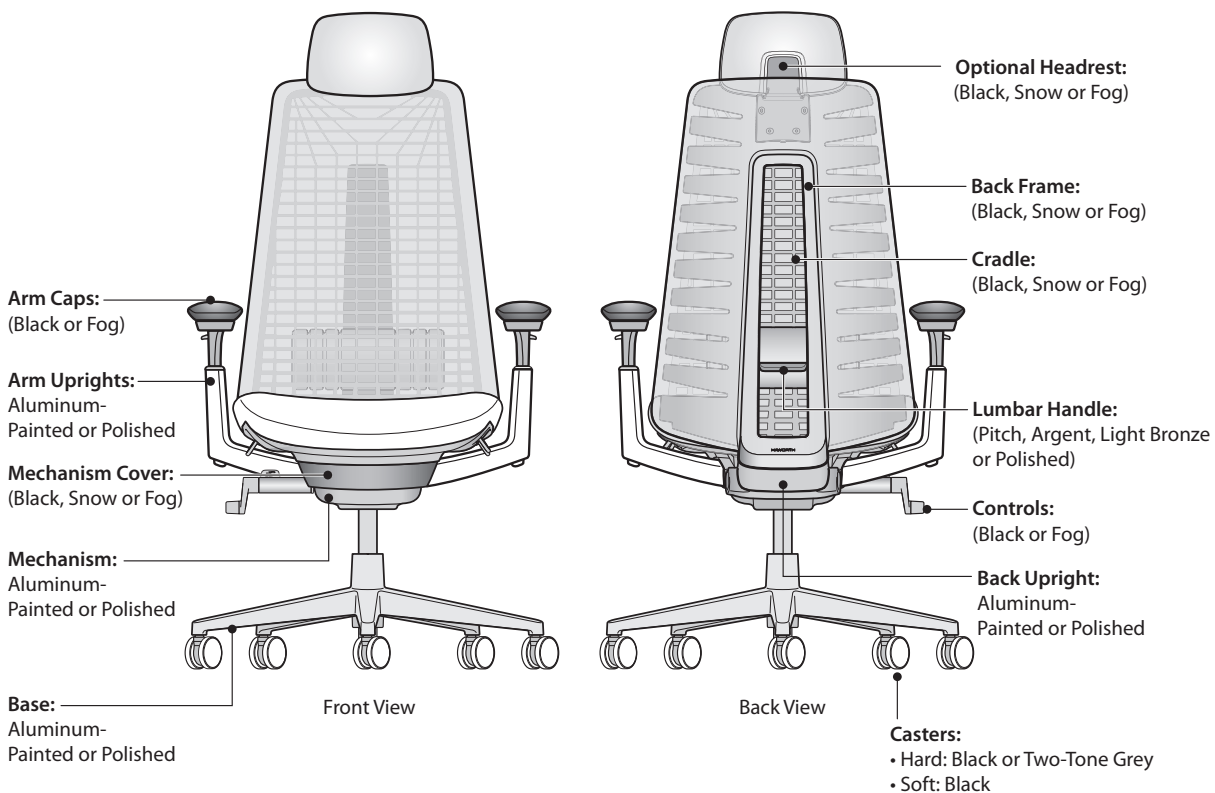

# Fern Task Chair

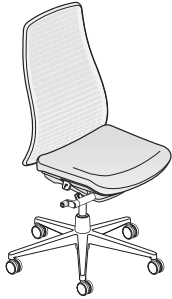

SFT-UO-0N01A



SFT-UO-1S01A



SFT-UO-4S01A



SFT-UO-7S01A  
Class FN

## Features

- Back: Flexible back with built in fronds wrapped in lofted mesh, knit or faux leather.
- Seat: Flexible seat pan with standard upholstered foam.
- Standard fixed seat. Optional seat depth adjustment (3”(76mm) range).
- Base Options:
  - Plastic standard five-star base.  
Casters: Hard casters in black or two-tone grey; Soft casters in black only.
  - Aluminum standard five-star base.  
Casters: Hard casters in black or two-tone grey; Soft casters in black only.
  - Aluminum low-position five-star base.  
Casters: Hard or Soft casters in black only.
- Arm Options:
  - No arms
  - Fixed with soft arm caps; Optional leather arm caps available when leather seat is specified. Leather arm caps will match leather seat.
  - Height Adjustable with soft arm caps; Adjustment range of 4.8”(122mm).
  - 4D with soft arm caps.
    - Move fore, aft, side-to-side and pivot in and out.
    - Height adjustment range of 4.8”(122mm).
- Optional height adjustable lumbar support; 4”(102mm) adjustment
- Optional headrest has an upholstered front with a plastic back. Headrest material and trim color are matched to the back.
- Mechanism: Synchronized 3-point tilt; standard tilt tension adjustment.
- Height Adjustment: Pneumatic or optional low position. Range: 15”(381mm)-17.5”(445mm).
- Back Stop: 5 positions.
- Optional Forward Tilt (with Back Stop): 5° downward from initial position.
- COM yardage / COL square footage: (Seat only) 0.71/8

## Specification Tips

- When Polished Aluminum trim is specified, lumbar handle will default to Polished Aluminum.
- When Light Bronze trim is specified, lumbar handle will default to Light Bronze.
- When Snowfall base is specified, all other aluminum components will default to Polished Aluminum.

## Dimensions

Height: 41.5-47”  
H: 41.5-47”  
(1054-1194mm)

Depth: 28.5”(724mm)  
D: 28.5”(724mm)  
\*SD: 15.5-18.5”  
(394-470mm)

Width: 29”(737mm)  
W: 29”(737mm)  
\*SW: 19.9”(505mm)

\*SH: 16.5-21.5”  
(419-546mm)

\*AH: 6.7-11.5”  
(170-292mm)

Low position SH: 15”-17.5”(381-445mm)

\*Measurements taken with the BIFMA chair measuring device.

## Plastic Base

Plastic Trim Color	Arm Cap/Levers	Lumbar Handle
TR-F Black	TR-F Black	TR-TF Pitch
TR-7 Fog	TR-7 Fog	TR-AR Argent

## Aluminum Base

Plastic Trim Color	Arm Cap/Levers	Lumbar Handle
TR-F Black	TR-F Black	TR-TF Pitch
TR-7 Fog	TR-7 Fog	TR-AR Argent
TR-UFM Snow	TR-7 Fog	TR-FS Snowfall
TR-UFM Snow w/2nd trim PM-P Polished Aluminum	TR-7 Fog	PM-P Polished Aluminum

## To Order, Specify:

1) Product number, including:

### 1 Base/Caster Option:

#### Plastic Standard Base

5 Hard Casters (Black)

6 Soft Casters (Black)  
(add **\$64.36** list)

7 Hard Two-Tone Casters  
(Grey)

#### Aluminum Standard Base

1 Std. Base Hard Casters  
(Black) (add **\$254.49** list)

2 Std. Base Soft Casters  
(Black) (add **\$318.85** list)

T Std. Base Hard Two-Tone  
Casters (Grey)  
(add **\$281.24** list)

#### Aluminum Low Base

3 Low Base, Hard Casters  
(Black) (add **\$254.49** list)

4 Low Base, Soft Casters  
(Black) (add **\$318.85** list)

- 2) Fabric surface and color (seat).
- 3) Mesh, knit or faux leather color (back).
- 4) Plastic trim color<sup>1</sup>  
TR-F Black  
TR-7 Fog  
TR-UFM Snow (Aluminum base model only) (add **\$92.08** list)
- 5) Aluminum trim color<sup>2</sup>  
TR-BG Light Bronze<sup>3</sup>  
TR-MC Metallic Champagne  
TR-LE Metallic Silver  
TR-TF Pitch  
TR-UFS Snowfall<sup>4</sup> (add **\$92.08** list)  
PM-P Polished Aluminum  
(add **\$150.67** list)

<sup>1</sup> Plastic base model: Back frame/ cradle, arm uprights and base.  
Aluminum base model: Back frame/cradle.

<sup>2</sup> Plastic base model: Back upright and mechanism.  
Aluminum base model: Back upright, mechanism, arm uprights and base.

<sup>3</sup> Available on aluminum base model only.

<sup>4</sup> Base only.

# Fern Task Chair

Plastic Base* Adjustments	Arms	Number ①	Fabric								Leather	
			A	B	C	D	E	F	G	H	A	B
<b>No Lumbar Adjustment - Mesh Back</b>												
Back Stop	No arm	SFT-UO-ON01A	\$ 1774.76	\$ 1831.67	\$ 1891.97	\$ 1922.09	\$ 1943.87	\$ 1997.46	\$ 2047.68	\$ 2179.93	\$ 2273.69	\$ 2511.44
	Fixed	SFT-UO-1S01A	1975.67	2032.58	2092.88	2123.00	2144.78	2198.37	2248.59	2380.84	2474.60	2712.35
	Height Adjustable	SFT-UO-4S01A	2000.80	2057.71	2118.01	2148.13	2169.91	2223.50	2273.72	2405.97	2499.73	2737.48
	4D	SFT-UO-7S01A	2042.63	2099.54	2159.84	2189.96	2211.74	2265.33	2315.55	2447.80	2541.56	2779.31
Back Stop/Forward Tilt	No arm	SFT-UO-ON04A	1908.70	1965.61	2025.91	2056.03	2077.81	2131.40	2181.62	2313.87	2407.63	2645.38
	Fixed	SFT-UO-1S04A	2109.61	2166.52	2226.82	2256.94	2278.72	2332.31	2382.53	2514.78	2608.54	2846.29
	Height Adjustable	SFT-UO-4S04A	2134.74	2191.65	2251.95	2282.07	2303.85	2357.44	2407.66	2539.91	2633.67	2871.42
	4D	SFT-UO-7S04A	2176.57	2233.48	2293.78	2323.90	2345.68	2399.27	2449.49	2581.74	2675.50	2913.25
<b>No Lumbar Adjustment - Knit Back</b>												
Back Stop	No arm	SFT-UU-ON01A	\$ 2042.55	\$ 2099.46	\$ 2159.76	\$ 2189.88	\$ 2211.66	\$ 2265.25	\$ 2315.47	\$ 2447.72	\$ 2541.48	\$ 2779.23
	Fixed	SFT-UU-1S01A	2243.46	2300.37	2360.67	2390.79	2412.57	2466.16	2516.38	2648.63	2742.39	2980.14
	Height Adjustable	SFT-UU-4S01A	2268.59	2325.50	2385.80	2415.92	2437.70	2491.29	2541.51	2673.76	2767.52	3005.27
	4D	SFT-UU-7S01A	2310.42	2367.33	2427.63	2457.75	2479.53	2533.12	2583.34	2715.59	2809.35	3047.10
Back Stop/Forward Tilt	No arm	SFT-UU-ON04A	2176.49	2233.40	2293.70	2323.82	2345.60	2399.19	2449.41	2581.66	2675.42	2913.17
	Fixed	SFT-UU-1S04A	2377.40	2434.31	2494.61	2524.73	2546.51	2600.10	2650.32	2782.57	2876.33	3114.08
	Height Adjustable	SFT-UU-4S04A	2402.53	2459.44	2519.74	2549.86	2571.64	2625.23	2675.45	2807.70	2901.46	3139.21
	4D	SFT-UU-7S04A	2444.36	2501.27	2561.57	2591.69	2613.47	2667.06	2717.28	2849.53	2943.29	3181.04
<b>Lumbar Adjustment - Mesh Back</b>												
Back Stop	No arm	SFT-UO-ON11A	\$ 1925.43	\$ 1982.34	\$ 2042.64	\$ 2072.76	\$ 2094.54	\$ 2148.13	\$ 2198.35	\$ 2330.60	\$ 2424.36	\$ 2662.11
	Fixed	SFT-UO-1S11A	2126.34	2183.25	2243.55	2273.67	2295.45	2349.04	2399.26	2531.51	2625.27	2863.02
	Height Adjustable	SFT-UO-4S11A	2151.47	2208.38	2268.68	2298.80	2320.58	2374.17	2424.39	2556.64	2650.40	2888.15
	4D	SFT-UO-7S11A	2193.30	2250.21	2310.51	2340.63	2362.41	2416.00	2466.22	2598.47	2692.23	2929.98
Back Stop/Forward Tilt	No arm	SFT-UO-ON14A	2059.37	2116.28	2176.58	2206.70	2228.48	2282.07	2332.29	2464.54	2558.30	2796.05
	Fixed	SFT-UO-1S14A	2260.28	2317.19	2377.49	2407.61	2429.39	2482.98	2533.20	2665.45	2759.21	2996.96
	Height Adjustable	SFT-UO-4S14A	2285.41	2342.32	2402.62	2432.74	2454.52	2508.11	2558.33	2690.58	2784.34	3022.09
	4D	SFT-UO-7S14A	2327.24	2384.15	2444.45	2474.57	2496.35	2549.94	2600.16	2732.41	2826.17	3063.92
<b>Lumbar Adjustment - Knit Back</b>												
Back Stop	No arm	SFT-UU-ON11A	\$ 2193.22	\$ 2250.13	\$ 2310.43	\$ 2340.55	\$ 2362.33	\$ 2415.92	\$ 2466.14	\$ 2598.39	\$ 2692.15	\$ 2929.90
	Fixed	SFT-UU-1S11A	2394.13	2451.04	2511.34	2541.46	2563.24	2616.83	2667.05	2799.30	2893.06	3130.81
	Height Adjustable	SFT-UU-4S11A	2419.26	2476.17	2536.47	2566.59	2588.37	2641.96	2692.18	2824.43	2918.19	3155.94
	4D	SFT-UU-7S11A	2461.09	2518.00	2578.30	2608.42	2630.20	2683.79	2734.01	2866.26	2960.02	3197.77
Back Stop/Forward Tilt	No arm	SFT-UU-ON14A	2327.16	2384.07	2444.37	2474.49	2496.27	2549.86	2600.08	2732.33	2826.09	3063.84
	Fixed	SFT-UU-1S14A	2528.07	2584.98	2645.28	2675.40	2697.18	2750.77	2800.99	2933.24	3027.00	3264.75
	Height Adjustable	SFT-UU-4S14A	2553.20	2610.11	2670.41	2700.53	2722.31	2775.90	2826.12	2958.37	3052.13	3289.88
	4D	SFT-UU-7S14A	2595.03	2651.94	2712.24	2742.36	2764.14	2817.73	2867.95	3000.20	3093.96	3331.71

\*Pricing based on Plastic Base, Hard Casters and Seat Depth Adjustment

The following options require modification of the product number.

- Fixed seat To specify, change the 10th digit from an **A to F**; **Example:** SFT-UO-7S01F5
- Faux Leather back To specify, change the fifth digit in the product number to **U** (Wellington; add **\$192.55** list, Brisa; add **\$497.26** list); **Example:** SFT-UU-7S01A5
- Gradient Knit Back To specify, change the fifth digit in the product number to **U** (deduct **\$52.67** list); **Example:** SFT-UU-7S01A1
- Headrest To specify, change the third digit from a **T to an E** (Mesh; add **\$247.91** list, Faux Leather/Knit; add **\$314.87** list); **Example:** SFE-UO-7S01A5
- Stain repellent (Seat only) To specify, add **P** to the end of the product number (add **\$58.60** list); **Example:** SFT-UO-7S01A5P

# Fern Task Stool



SFS-UO-0N01A



SFS-UO-1S01A



SFS-UO-4S01S



SFS-UO-7S01A  
Class FN

## Features

- Back: Flexible back with built in fronds wrapped in lofted mesh, knit or faux leather.
- Seat: Flexible seat pan with standard upholstered foam.
- Standard fixed seat. Optional seat depth adjustment (3"(76mm) range).
- Base Options:
  - Plastic standard five-star base. Casters: Hard casters in black or two-tone grey; Soft casters in black only.
  - Aluminum standard five-star base. Casters: Hard casters in black or two-tone grey; Soft casters in black only.
- Arm Options:
  - No arms
  - Fixed with soft arm caps; Optional leather arm caps available when leather seat is specified. Leather arm caps will match leather seat.
  - Height Adjustable with soft arm caps; Adjustment range of 4.8"(122mm).
  - 4D with soft arm caps.
    - Move fore, aft, side-to-side and pivot in and out.
    - Height adjustment range of 4.8"(122mm).
- Optional height adjustable lumbar support; 4"(102mm) adjustment
- Height Adjustment: Pneumatic. Range: 21.75"(552mm)-29.25"(743mm).
- Back Stop: 5 positions.
- Footring: Adjusts 1.5"(38mm) up and down. Brushed aluminum finish.
- COM yardage / COL square footage: (Seat only) 0.71/8

## Specification Tips

- When Polished Aluminum trim is specified, lumbar handle will default to Polished Aluminum.
- When Light Bronze trim is specified, lumbar handle will default to Light Bronze.
- When Snowfall base is specified, all other aluminum components will default to Polished Aluminum.

## Dimensions

Height:	Depth:	Width:
H: 46.75-54.75" (1187-1391mm)	D: 28.5"(724mm)	W: 29"(737mm)
*SH: 21.75-29.25" (552-743mm)	*SD: 15.5-18.5" (394-470mm)	*SW: 19.9"(505mm)
*AH: 6.7-11.5" (170-292mm)		

\*Measurements taken with the BIFMA chair measuring device.

## Plastic Base

Plastic Trim Color	Arm Cap/Levers	Lumbar Handle
TR-F Black	TR-F Black	TR-TF Pitch
TR-7 Fog	TR-7 Fog	TR-AR Argent

## Aluminum Base

Plastic Trim Color	Arm Cap/Levers	Lumbar Handle
TR-F Black	TR-F Black	TR-TF Pitch
TR-7 Fog	TR-7 Fog	TR-AR Argent
TR-UFM Snow	TR-7 Fog	TR-FS Snowfall
TR-UFM Snow w/2nd trim PM-P Polished Aluminum	TR-7 Fog	PM-P Polished Aluminum

## To Order, Specify:

1) Product number, including:

### 1 Base/Caster Option:

#### Plastic Standard Base

5 Hard Casters (Black)

6 Soft Casters (Black)  
(add **\$64.36** list)

7 Hard Two-Tone Casters  
(Grey)

#### Aluminum Standard Base

1 Std. Base Hard Casters  
(Black) (add **\$254.49** list)

2 Std. Base Soft Casters  
(Black) (add **\$318.85** list)

T Std. Base Hard Two-Tone  
Casters (Grey)  
(add **\$281.24** list)

2) Fabric surface and color (seat).

3) Mesh, knit or faux leather color  
(back).

4) Plastic trim color<sup>1</sup>

TR-F Black

TR-7 Fog

TR-UFM Snow (Aluminum base  
model only) (add **\$92.08** list)

5) Aluminum trim color<sup>2</sup>

TR-BG Light Bronze<sup>3</sup>

TR-MC Metallic Champagne

TR-LE Metallic Silver

TR-TF Pitch

TR-UFS Snowfall<sup>4</sup> (add **\$92.08**  
list)

PM-P Polished Aluminum

(add **\$150.67** list)

<sup>1</sup> Plastic base model: Back frame/  
cradle, arm uprights and base.  
Aluminum base model: Back  
frame/cradle.

<sup>2</sup> Plastic base model: Back upright  
and mechanism.  
Aluminum base model: Back  
upright, mechanism, arm uprights  
and base.

<sup>3</sup> Available on aluminum base  
model only.

<sup>4</sup> Base only.

# Fern

## Task Stool

Plastic Base*			Fabric								Leather	
Adjustments	Arms	Number ①	A	B	C	D	E	F	G	H	A	B
<b>No Lumbar Adjustment - Mesh Back</b>												
Back Stop	No arm	SFS-UO-ON01A	\$ 2447.81	\$ 2504.72	\$ 2565.02	\$ 2595.14	\$ 2616.92	\$ 2670.51	\$ 2720.73	\$ 2852.98	\$ 2946.74	\$ 3184.49
	Fixed	SFS-UO-IS01A	2648.72	2705.63	2765.93	2796.05	2817.83	2871.42	2921.64	3053.89	3147.65	3385.40
	Height Adjustable	SFS-UO-4S01A	2673.85	2730.76	2791.06	2821.18	2842.96	2896.55	2946.77	3079.02	3172.78	3410.53
	4D	SFS-UO-7S01A	2715.68	2772.59	2832.89	2863.01	2884.79	2938.38	2988.60	3120.85	3214.61	3452.36
<b>No Lumbar Adjustment - Knit Back</b>												
Back Stop	No arm	SFS-UU-ON01A	\$ 2715.60	\$ 2772.51	\$ 2832.81	\$ 2862.93	\$ 2884.71	\$ 2938.30	\$ 2988.52	\$ 3120.77	\$ 3214.53	\$ 3452.28
	Fixed	SFS-UU-IS01A	2916.51	2973.42	3033.72	3063.84	3085.62	3139.21	3189.43	3321.68	3415.44	3653.19
	Height Adjustable	SFS-UU-4S01A	2941.64	2998.55	3058.85	3088.97	3110.75	3164.34	3214.56	3346.81	3440.57	3678.32
	4D	SFS-UU-7S01A	2983.47	3040.38	3100.68	3130.80	3152.58	3206.17	3256.39	3388.64	3482.40	3720.15
<b>Lumbar Adjustment - Mesh Back</b>												
Back Stop	No arm	SFS-UO-ON11A	\$ 2598.48	\$ 2655.39	\$ 2715.69	\$ 2745.81	\$ 2767.59	\$ 2821.18	\$ 2871.40	\$ 3003.65	\$ 3097.41	\$ 3335.16
	Fixed	SFS-UO-IS11A	2799.39	2856.30	2916.60	2946.72	2968.50	3022.09	3072.31	3204.56	3298.32	3536.07
	Height Adjustable	SFS-UO-4S11A	2824.52	2881.43	2941.73	2971.85	2993.63	3047.22	3097.44	3229.69	3323.45	3561.20
	4D	SFS-UO-7S11A	2866.35	2923.26	2983.56	3013.68	3035.46	3089.05	3139.27	3271.52	3365.28	3603.03
<b>Lumbar Adjustment - Knit Back</b>												
Back Stop	No arm	SFS-UU-ON11A	\$ 2866.27	\$ 2923.18	\$ 2983.48	\$ 3013.60	\$ 3035.38	\$ 3088.97	\$ 3139.19	\$ 3271.44	\$ 3365.20	\$ 3602.95
	Fixed	SFS-UU-IS11A	3067.18	3124.09	3184.39	3214.51	3236.29	3289.88	3340.10	3472.35	3566.11	3803.86
	Height Adjustable	SFS-UU-4S11A	3092.31	3149.22	3209.52	3239.64	3261.42	3315.01	3365.23	3497.48	3591.24	3828.99
	4D	SFS-UU-7S11A	3134.14	3191.05	3251.35	3281.47	3303.25	3356.84	3407.06	3539.31	3633.07	3870.82

\*Pricing based on Plastic Base, Hard Casters and Seat Depth Adjustment

The following options require modification of the product number.

- Fixed seat To specify, change the 10th digit from an **A to F**; **Example:** SFS-UO-7S01F5
- Faux Leather back To specify, change the fifth digit in the product number to **U** (Wellington; add **\$192.55** list, Brisa; add **\$497.26** list); **Example:** SFS-UU-7S01A5
- Gradient Knit Back To specify, change the fifth digit in the product number to **U** (deduct **\$52.67** list); **Example:** SFT-UU-7S01A1
- Stain repellent (Seat only) To specify, add **P** to the end of the product number (add **\$58.60** list); **Example:** SFS-UO-7S01A5P

# Zody II

## At-A-Glance

**Designer** ITO Design and Haworth Design Studio

**Awards/Achievements** NeoCon Silver, Best of NeoCon, Seating: Ergonomic Desk/Task, June 2022, USA  
 Metropolis Likes: Task Seating (winner) June 2022, USA  
 Greenguard Gold  
 Cradle to Cradle Certified Bronze

**Zody II** A high-performing chair that blends science-based wellness and comfort with sustainability and international design.

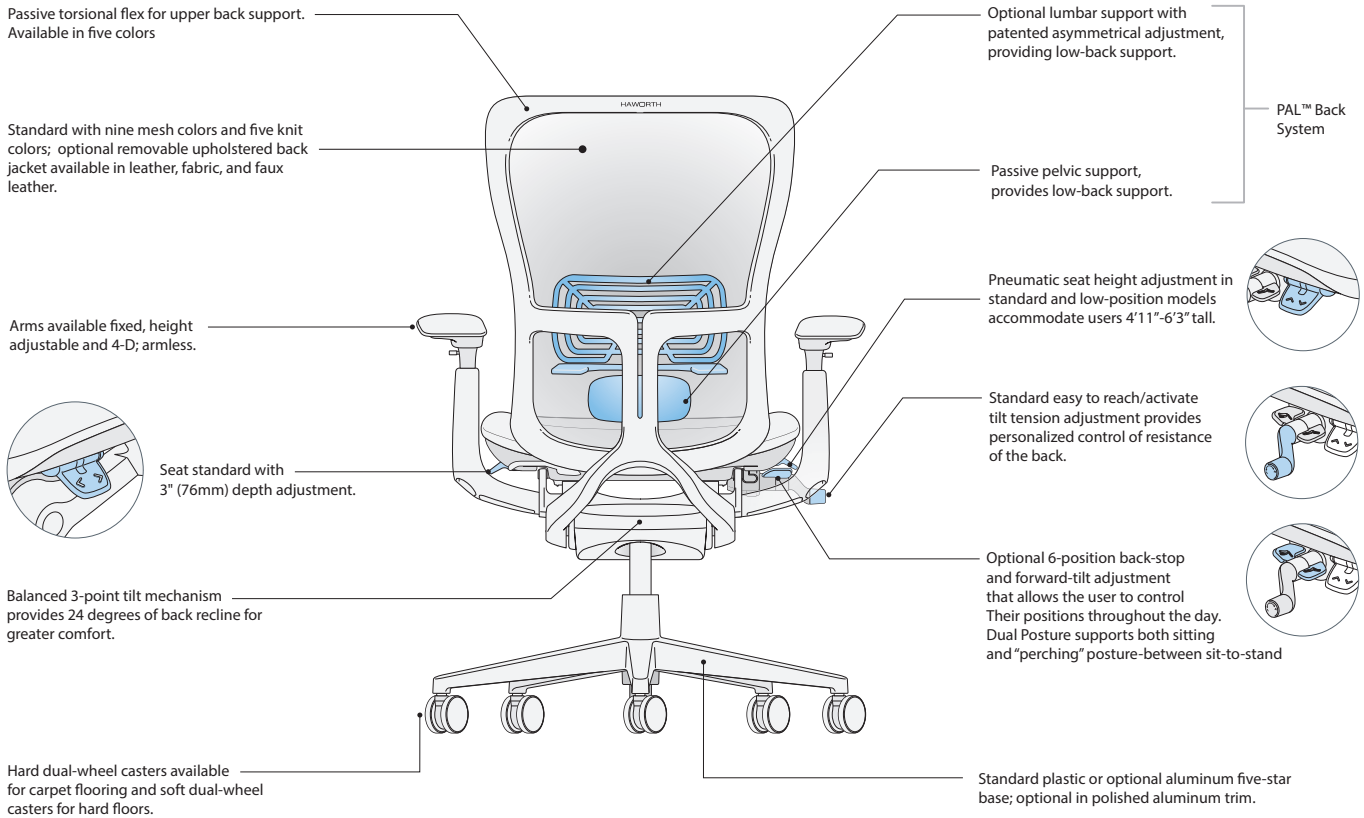

**Note:** Headrest and forward-tilt options available on task chair only.

# Zody II

## At-A-Glance

### Catalog Logic

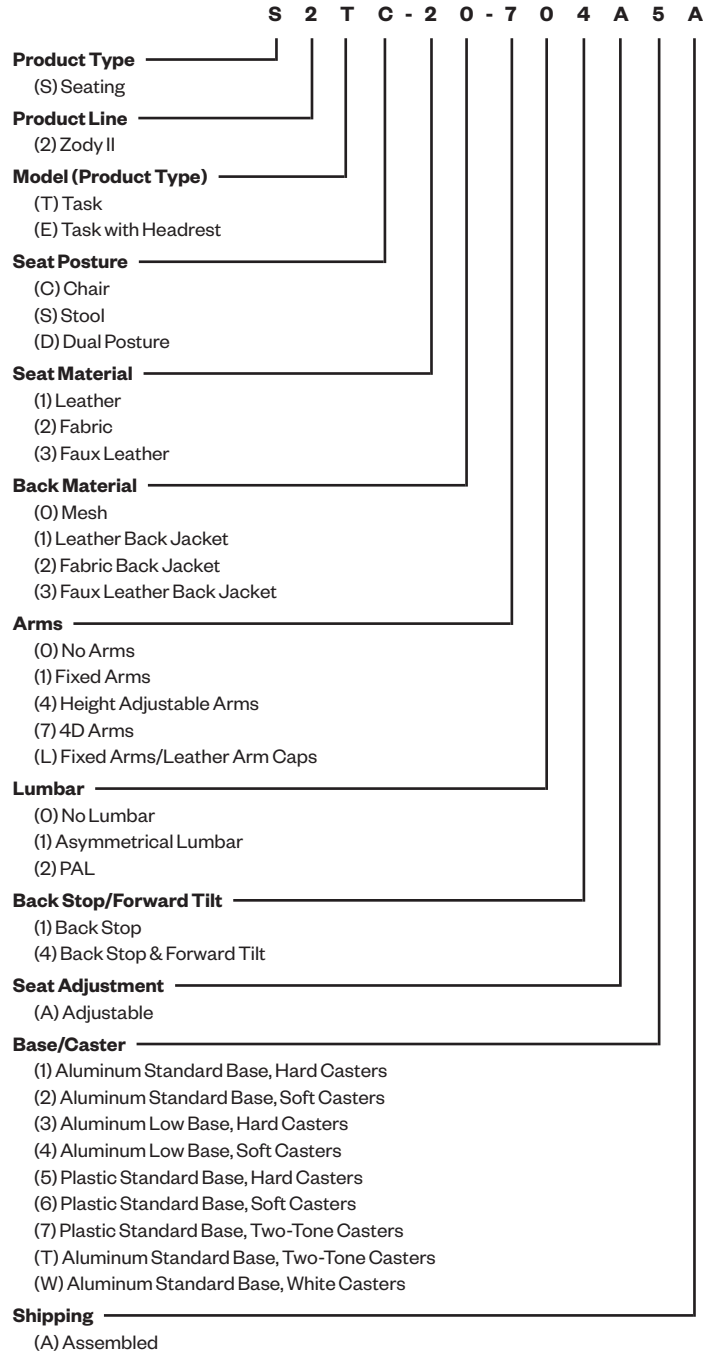

# Zody II

## At-A-Glance

---

### Environmental Factors

- Zody II has been evaluated for its human health, environmental health, lifecycle attributes, renewable energy, water stewardship and social responsibility characteristics against stringent certification criteria and is considered an ecologically intelligent product.
- Refer to Product Environmental Data sheet (PED) for recycled content and certifications.
- Zody II is produced in an ISO 14001 certified manufacturing facility.
- Components are identified with ISO recycling symbols and material information to assist in the recycling effort, where practical.
- Haworth will take back Zody II chairs after their useful life and recycle the components. Please contact Haworth's Material Recovery Center at (616)393-1215.

---

### COM & COL General Information

To order a COM fabric (Customer's Own Material), contact the Haworth Inquiry Center (1.800.426.8562), your local Haworth dealer, or go to [surfaces.haworth.com](http://surfaces.haworth.com) to find out if the COM you have selected has already been tested and approved. The surface collection site also has information on the Haworth alliance program with Carnegie, Luna Textiles, and Maharam as well as our industry-leading Pre-Approved COM program.

COM fabrics are placed into Grades based on the cost per linear yard. If a fabric's cost exceeds the range of our highest Grade it will be noted as Non-Graded. The product will be priced at Grade A; the COM fabric costs will appear as a separate line item. The fabric charge will be Haworth's purchase cost plus a 4% administrative fee (based on the cost of the fabric). Yardage calculations will include any applicable fabric repeat.

COM Leather products will be priced at a leather Grade A; COL costs will appear as a separate line item. The leather costs will be Haworth's purchase cost plus a 4% administrative fee (based on the cost of the leather).

---

### Finishes and Fabrics

For available finishes and fabrics please visit [surfaces.haworth.com](http://surfaces.haworth.com)

---

### Stain Repellent

Stain Repellent or Stain Repellent with Moisture Barrier available on fabric surfaces only.

Stain Repellent only: To specify add "**P**" to the end of the product number. Example: S2TC-20-714A5**AP**

Stain Repellent with Moisture Barrier: To specify add "**D**" to the end of the product number. Example: S2TC-20-714A5**AD**

---

### Shipping Weights (Including packaging)

- Chairs with arms: 55 pounds/1 chair per carton/19.4 cubic feet
- Chairs without arms: 49 pounds/1 chair per carton/19.4 cubic feet
- Dual Posture with arms: 57.6 pounds/1 chair per carton/22.1 cubic feet
- Dual Posture without arms: 51.6 pounds/1 chair per carton/22.1 cubic feet
- Stool with arms: 58 pounds/1 stool per carton/22.1 cubic feet
- Stool without arms: 52 pounds/1 stool per carton/22.1 cubic feet

---

### Specifications

Task chairs and stools designed for use by individuals up to 350 lbs.\*

\* Task chairs with forward tilt are designed for use by individuals up to 325lbs.  
Select configurations are available for use by individuals up to 400lbs.

# Zody II

## At-A-Glance — Standard Mobility and Adjustability

### Balanced 3-point Tilt



#### Features

- Balanced 3-point tilt mechanism.
- Back reclines 24° from the upright position.
- Seat pan moves downward 3° from the initial position.

#### Benefits

- Comfortable relaxed posture.
- Recline allows for the opening of the users' chest cavity providing good airflow to promote alertness.
- Users' feet remain flat.

### Tilt Tension Control

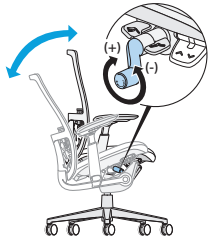

#### Feature

- Easy-to-reach and easy-to-activate side-mounted tilt tension control regulates the amount of resistance felt when leaning back in the chair and the effort required to recline the chair backwards.

#### Benefit

- Personalized support to accommodate users of different body types and different work styles.

### Seat Height Adjustment

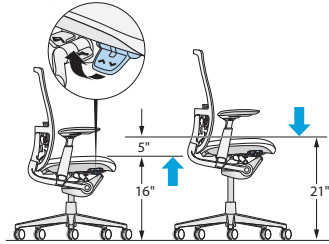

Fully Retracted

Fully Extended

#### Features

- Pneumatic seat height adjustment.
- Task chair seat height adjusts 5" (127mm) from 16" to 21" (406mm to 533mm) in standard models. Low-position adjusts 14.7" to 18" (373 to 457mm).
- Task stool seat height adjusts 7.3" (185mm) from 21" to 28.3" (533mm to 719mm).
- Dual Posture seat height adjusts 17.5" to 24.2" (445mm to 615mm).

#### Benefits

- Ensures the comfort of the lower limbs by avoiding pressure on the underside of the thigh caused by a seat pan that is too high, or decreased thigh-to-torso angle if the seat pan is too low.
- Accommodates for users between approximately 4'11" (1499mm) and 6'3" (1905mm) tall to provide good leg circulation.
- Seat height adjustment also is important in setting the proper hand position and allowing for a proper sitting eye height.

### Seat Depth Adjustment

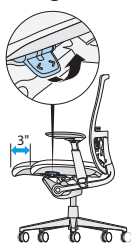

#### Features

- 3" (76mm) of seat depth range.
- Waterfall edge.

#### Benefit

- Supports the thighs, allows users to rest against the seat back for back support, and avoids pressure on the back of the knees of small to tall users.

### Upper Back Torsional Movement



#### Features

- Passive 2" (51mm) of torsional flex in the upper back.
- Patented mesh with built in tension zones for added comfort.

#### Benefits

- Increases users' mobility and comfort when reaching sideways for objects.

# Zody II

## At-A-Glance — Optional Mobility and Adjustability

### PAL Back System

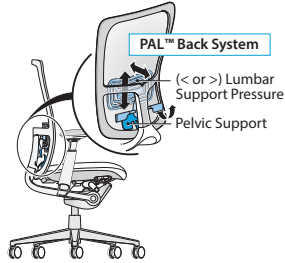

#### Features

- PAL Back System includes Asymmetrical Lumbar Adjustment and passive pelvic support.
- Asymmetrical Lumbar Adjustment adjusts 4”(102mm) in height; support level can be adjusted independently for right or left-hand side of users' body.
- Passive pelvic support.

#### Benefits

- Lumbar adjustment maintains the natural curvature of the spine at the lower back and allows users to choose the support that feels right for them.
- Passive pelvic support rotates the pelvis forward to maintain the natural spine shape.

### 4D Arm

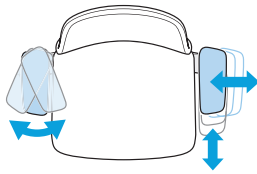

#### Features

- Optional 4D arm.
- Arm adjusts in 4 ways:
  - Height adjustment: 4”(102mm)
  - Side-to-side arm cap adjustment range: 4”(102mm) [2”(51mm) each arm cap]
  - Front-to-back adjustment range: 2”(51mm)
  - Pivoting: In 20°; out 20°

#### Benefits

- Arms support the muscular system of users' neck and shoulders and proper arm support provides back relief. Arms can be an aid in standing or sitting down.
- Height adjustment accommodates for users with varying elbow rest heights so that users avoid lifting their shoulders or leaning sideways to get arm support.
- Front-to-back adjustment adjusts the armrest length, which is important because it allows users to get close to the worksurface while maintaining the effective use of the backrest.
- Side-to-side adjustment ensures a comfortable resting position for the arms with proper support of the forearm while allowing for easy entry/exit of the chair.
- Pivoting provides proper support of the forearm when performing tasks involving keying and mousing.

### Adjustable Height Arm

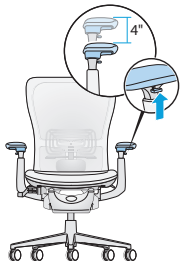

#### Feature

- Optional height adjustable arms adjust 4”(102mm) vertically.

#### Benefit

- Height adjustment accommodates users with varying elbow rest heights so that users avoid lifting their shoulders or leaning sideways to get arm support.

### Back Stop

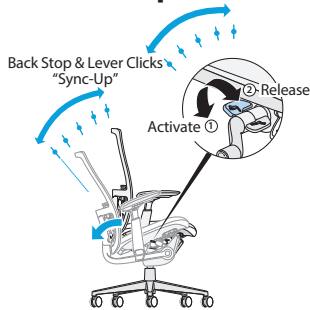

#### Feature

- Optional back stop;
  - Back stops in 6 positions - upright and every 4° backward.

#### Benefit

- Allows users the choice of selecting an upright position or limiting the amount of recline while performing different tasks.

# Zody II

## At-A-Glance — Optional Mobility and Adjustability

### Back Stop/ Forward Tilt

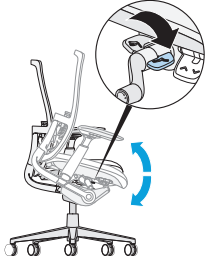

#### Features

- Optional back-stop and forward tilt.
- Back stops in 6 positions, upright and every 4° backward.
- Seat pan moves downward 5° from the initial position.

#### Benefits

- Allows users to sit forward in the chair for task intensive work.
- Allows users to vary their posture for maximum comfort and for changes in task requirements.

**Note:** Not available on task stool.

### Dual Posture

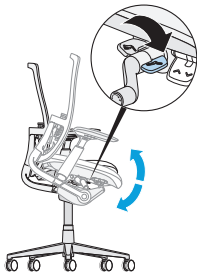

#### Features

- Increased seat height range of 17.5"(445mm)-24.1"(612mm).
- Seat pan moves downward 5° from initial position with an increased degree of forward tilt.

#### Benefit

- Promotes the in-between "perch" posture of sit-to-stand. Ideal for use with a height adjustable table.

### Base

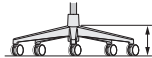
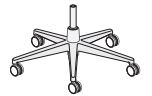

Standard Plastic Base

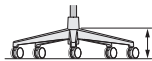
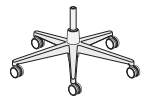

Optional Aluminum Base



Low Position Base  
(Aluminum only)

#### Colors

- TR-F Black
- TR-7 Fog

**Note:** When plastic base is specified all metal trim defaults to base color.

#### Casters

Hard casters in Black or Two-Tone Grey.  
Soft casters in Black.

#### Colors

- TR-BG Light Bronze
- TR-TF Pitch
- TR-LE Metallic Silver
- TR-MC Metallic Champagne
- TR-UFS Snowfall
- PM-P Polished Aluminum

#### Casters

Hard casters in Black, Two-Tone White or Two-Tone Grey.  
Soft casters in Black.

#### Colors

- TR-BG Light Bronze
- TR-TF Pitch
- TR-LE Metallic Silver
- TR-MC Metallic Champagne
- TR-UFS Snowfall

**Note:** Low Position Base available on task chair only.

#### Casters

Hard or soft casters in Black.

### Ergonomic Standards Guidelines

- All Zody II models meet or exceed all ANSI/BIFMA durability standards for office seating.
- Zody II meets the following ergonomic standards/guidelines:
  - BSR/HFES 100-2002
  - BIFMA G1-2002
  - CSA-Z412-2000
  - CAN/CGSB 44.232-2002
  - HFES 2007

# Zody II

## At-A-Glance — Upholstery/Aesthetic Options

### Leather Upholstery



**Seat:** Stitched double seams. Vertically in the center and on the edges of the seat cushion.

**Back:** Vertical stitched double seams on the upholstered back jacket with leather or Customers Own Leather (COL).

### Upholstered Back Jacket

Front View:



Back View:



Leather Jacket

#### Features

- Removable.
- Back jacket covers the inside back of the chairs allowing a back view of the mesh. Jacket consists of padding covered with fabric or leather upholstery.
- Available in fabric, faux leather, leather, COM and COL.

### Headrest



#### Features

- Height-adjustable 2.5"(64mm) to fit a wide range of users, headrest is TPU material, like Zody II arm.
- Trim color of headrest front and back are in same color. Black or Fog only. If a trim color other than Black or Fog is specified, the headrest will default to Black or Fog based on the matrix below.
- Headrest sent not attached; 10.5"(267mm)W x 7.5"(191mm)H, 2.5"(64mm) height adjustment.
- See Zody II price pages for specification (available on all task seating models). Not available on stools or Dual Posture. Specification Example: S2EC-20-714A5A

To add a headrest to an existing model in the field order service part: Back and Headrest replacement, see e-Parts.

### Specification

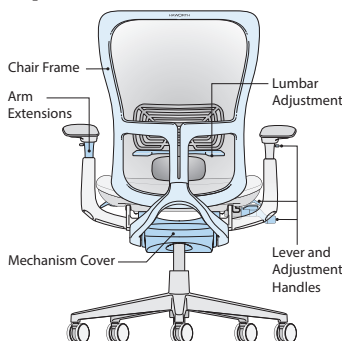

#### Features

- Trim color specification applies to the following components:
  - Chair frame
  - Levers
  - Adjustment handles
  - Lumbar adjustment (not lumbar pad)
  - Arm extensions
  - Mechanism covers
- Arm cap and Headrest color defaults based on the matrix below.

Trim Color	Arm Cap & Headrest Color*	
	Black	Fog
Black (TR-F)	•	
Fog (TR-7)		•
Snow (TR-UFM)		•

\*Not specifiable.

# Zody II

## Task Chair



S2TC-20-0



S2TC-20-1



S2TC-20-4



S2TC-20-7  
Class ZD1

### Features

- Back: Knit, mesh, or mesh back with upholstered back jacket.
- Seat: Upholstered with 3"(76mm) adjustable seat depth range.
- Base options:
  - Plastic standard five-star base. Casters: Hard casters in black or two-tone grey; Soft casters black only.
  - Aluminum standard five-star base. Casters: Hard casters in black, two-tone white or two-tone grey; Soft casters black only.
  - Aluminum low-position five-star base. Not available in PM-P Polished Aluminum. Casters: Hard or soft casters in black only.
  - Aluminum base available on chairs with arms only. Not available on armless chairs.
- Arm options:
  - No arms
  - Fixed arms; Optional leather arm caps available when leather seat is specified. Leather arm caps will match seat.
  - Height Adjustable; 4"(102mm) height adjustment range.
  - 4D; 4"(102mm) height adjustment, 4"(102mm) side-to-side range, 2"(51mm) front-to-back range and pivots 20° in and 20° out.
- Arm Cap will match plastic trim color (Black or Fog). When Snow is specified, arm cap will default to Fog.
- Height adjustment: Pneumatic or low-position pneumatic.
- Back Stop: Tilt stop in 6 positions.
- Back Stop/Forward Tilt; Tilt stop in 6 positions plus forward tilt 5° downward from initial position.
- Lumbar adjustment options:
  - No Lumbar
  - Asymmetrical Lumbar Adjustment: 4"(102mm) height adjustment; support level can be adjusted independently for right or left hand side of user's body.
  - PAL Back System: Asymmetrical lumbar adjustment with passive pelvic support.
- COM yardage / COL square footage:
  - Upholstered back jacket: 0.75/10
  - Seat: 0.75/10

**Note:** When specifying upholstered back jacket; must also specify mesh surface color for outside back.

Upcharge for mixed grade surfaces, refer to the electronic design and specification tools.

### Dimensions

Height	Depth	Width:
H: 38-43" (965-1092mm) (Std. base)	D: 29"(737mm) *SD: 16.8-19.5" (427-495mm) (with lumbar)	W: 29"(737mm) *SW: 19.5"(495mm)
36.7-40" (932-1016mm) (Low base)	17.5-20.2" (445-513mm) (no lumbar)	
*SH: 16-21" (406-533mm) (Std. base)		
14.7-18"(373-457mm) (Low base)		
*AH: 7.6-11.6" (193-295mm) (Height Adjustable and 4D)		
8.5"(216mm) (Fixed)		

\*Measurements taken with the BIFMA chair measuring device.

### To Order, Specify:

1) Product number, including:

#### 1 Seat Material:

- 1 Leather
- 2 Fabric
- 3 Faux Leather

#### 2 Base/Caster Option:

##### Plastic Base

- 5 Plastic Base, Hard Caster
- 6 Plastic Base, Soft Caster (add **\$64.99** list)
- 7 Plastic Base, Two-Tone Grey Caster (add **\$26.75** list)

##### Aluminum Base

- 1 Aluminum Base, Hard Caster (add **\$112.32** list)
- 2 Aluminum Base, Soft Caster (add **\$177.31** list)
- T Aluminum Base, Two-Tone Grey Caster (add **\$139.07** list)
- W Aluminum Base, White Caster (add **\$139.07** list)

##### Low Base - Aluminum

- 3 Aluminum Low Base, Hard Caster (add **\$112.32** list)
- 4 Aluminum Low Base, Soft Caster (add **\$177.31** list)

- 2) Seat upholstery.
- 3) Back upholstery (Mesh or Knit).
- 4) Back jacket surface and color (if applicable).
- 5) Plastic trim color.<sup>1</sup>
  - TR-F Black
  - TR-7 Fog (add **\$112.32** list)
  - TR-UFM Snow<sup>2</sup> (add **\$187.20** list)
- 6) Aluminum trim color.<sup>3</sup>
  - TR-BG Light Bronze<sup>4</sup>
  - TR-TF Pitch
  - TR-LE Metallic Silver
  - TR-MC Metallic Champagne
  - TR-UFS Snowfall
  - PM-P Polished Aluminum
- 7) Base trim color.
  - Plastic*
    - TR-F Black
    - TR-7 Fog (add **\$24.96** list)
  - Aluminum*
    - TR-BG Light Bronze<sup>4</sup>
    - TR-TF Pitch
    - TR-LE Metallic Silver
    - TR-MC Metallic Champagne
    - TR-UFS Snowfall (add **\$24.96** list)
    - PM-P Polished Aluminum (add **\$361.91** list)

<sup>1</sup> Plastic trim color for back frame, arm caps, seat pan cover.

<sup>2</sup> When TR-UFM Snow trim is specified, arm cap and head rest will default to TR-7 Fog.

<sup>3</sup> Aluminum trim color for arm supports/uprights.

<sup>4</sup> Available on aluminum base model only.

# Zody II

## Task Chair

Plastic Base* Adjustments	Arm	Number		Fabric								Leather		
		①	②	A	B	C	D	E	F	G	H	A	B	
<b>No Lumbar Adjustment - Mesh Back</b>														
Back Stop	No arm	S2TC-	0-001A	A	\$ 1216.35	\$ 1257.47	\$ 1301.30	\$ 1323.25	\$ 1339.68	\$ 1379.44	\$ 1415.05	\$ 1512.37	\$ 1821.09	\$ 2027.34
	Fixed	S2TC-	0-101A	A	1416.02	1457.14	1500.97	1522.92	1539.35	1579.11	1614.72	1712.04	2020.76	2227.01
	Height Adjustable	S2TC-	0-401A	A	1465.94	1507.06	1550.89	1572.84	1589.27	1629.03	1664.64	1761.96	2070.68	2276.93
	4D	S2TC-	0-701A	A	1508.36	1549.48	1593.31	1615.26	1631.69	1671.45	1707.06	1804.38	2113.10	2319.35
Back Stop/Forward Tilt	No arm	S2TC-	0-004A	A	1348.63	1389.75	1433.58	1455.53	1471.96	1511.72	1547.33	1644.65	1953.37	2159.62
	Fixed	S2TC-	0-104A	A	1548.30	1589.42	1633.25	1655.20	1671.63	1711.39	1747.00	1844.32	2153.04	2359.29
	Height Adjustable	S2TC-	0-404A	A	1598.22	1639.34	1683.17	1705.12	1721.55	1761.31	1796.92	1894.24	2202.96	2409.21
	4D	S2TC-	0-704A	A	1640.64	1681.76	1725.59	1747.54	1763.97	1803.73	1839.34	1936.66	2245.38	2451.63
<b>No Lumbar Adjustment - Knit Back</b>														
Back Stop	No arm	S2TC-	0-001A	A	\$ 1381.08	\$ 1422.20	\$ 1466.03	\$ 1487.98	\$ 1504.41	\$ 1544.17	\$ 1579.78	\$ 1677.10	\$ 1985.82	\$ 2192.07
	Fixed	S2TC-	0-101A	A	1580.75	1621.87	1665.70	1687.65	1704.08	1743.84	1779.45	1876.77	2185.49	2391.74
	Height Adjustable	S2TC-	0-401A	A	1630.67	1671.79	1715.62	1737.57	1754.00	1793.76	1829.37	1926.69	2235.41	2441.66
	4D	S2TC-	0-701A	A	1673.09	1714.21	1758.04	1779.99	1796.42	1836.18	1871.79	1969.11	2277.83	2484.08
Back Stop/Forward Tilt	No arm	S2TC-	0-004A	A	1513.36	1554.48	1598.31	1620.26	1636.69	1676.45	1712.06	1809.38	2118.10	2324.35
	Fixed	S2TC-	0-104A	A	1713.03	1754.15	1797.98	1819.93	1836.36	1876.12	1911.73	2009.05	2317.77	2524.02
	Height Adjustable	S2TC-	0-404A	A	1762.95	1804.07	1847.90	1869.85	1886.28	1926.04	1961.65	2058.97	2367.69	2573.94
	4D	S2TC-	0-704A	A	1805.37	1846.49	1890.32	1912.27	1928.70	1968.46	2004.07	2101.39	2410.11	2616.36
<b>No Lumbar Adjustment - Back Jacket</b>														
Back Stop	No arm	S2TC-	2-001A	A	\$ 1372.35	\$ 1454.00	\$ 1541.04	\$ 1584.61	\$ 1617.25	\$ 1696.21	\$ 1766.89	\$ 1960.15	\$ 2867.50	\$ 3367.92
	Fixed	S2TC-	2-101A	A	1572.02	1653.67	1740.71	1784.28	1816.92	1895.88	1966.56	2159.82	3067.17	3567.59
	Height Adjustable	S2TC-	2-401A	A	1621.94	1703.59	1790.63	1834.20	1866.84	1945.80	2016.48	2209.74	3117.09	3617.51
	4D	S2TC-	2-701A	A	1664.36	1746.01	1833.05	1876.62	1909.26	1988.22	2058.90	2252.16	3159.51	3659.93
Back Stop/Forward Tilt	No arm	S2TC-	2-004A	A	1504.63	1586.28	1673.32	1716.89	1749.53	1828.49	1899.17	2092.43	2999.78	3500.20
	Fixed	S2TC-	2-104A	A	1704.30	1785.95	1872.99	1916.56	1949.20	2028.16	2098.84	2292.10	3199.45	3699.87
	Height Adjustable	S2TC-	2-404A	A	1754.22	1835.87	1922.91	1966.48	1999.12	2078.08	2148.76	2342.02	3249.37	3749.79
	4D	S2TC-	2-704A	A	1796.64	1878.29	1965.33	2008.90	2041.54	2120.50	2191.18	2384.44	3291.79	3792.21
<b>Asymmetrical Lumbar Adjustment - Mesh Back</b>														
Back Stop	No arm	S2TC-	0-011A	A	\$ 1337.40	\$ 1378.52	\$ 1422.35	\$ 1444.30	\$ 1460.73	\$ 1500.49	\$ 1536.10	\$ 1633.42	\$ 1942.14	\$ 2148.39
	Fixed	S2TC-	0-111A	A	1537.07	1578.19	1622.02	1643.97	1660.40	1700.16	1735.77	1833.09	2141.81	2348.06
	Height Adjustable	S2TC-	0-411A	A	1586.99	1628.11	1671.94	1693.89	1710.32	1750.08	1785.69	1883.01	2191.73	2397.98
	4D	S2TC-	0-711A	A	1629.41	1670.53	1714.36	1736.31	1752.74	1792.50	1828.11	1925.43	2234.15	2440.40
Back Stop/Forward Tilt	No arm	S2TC-	0-014A	A	1469.68	1510.80	1554.63	1576.58	1593.01	1632.77	1668.38	1765.70	2074.42	2280.67
	Fixed	S2TC-	0-114A	A	1669.35	1710.47	1754.30	1776.25	1792.68	1832.44	1868.05	1965.37	2274.09	2480.34
	Height Adjustable	S2TC-	0-414A	A	1719.27	1760.39	1804.22	1826.17	1842.60	1882.36	1917.97	2015.29	2324.01	2530.26
	4D	S2TC-	0-714A	A	1761.69	1802.81	1846.64	1868.59	1885.02	1924.78	1960.39	2057.71	2366.43	2572.68
<b>Asymmetrical Lumbar Adjustment - Knit Back</b>														
Back Stop	No arm	S2TC-	0-011A	A	\$ 1502.13	\$ 1543.25	\$ 1587.08	\$ 1609.03	\$ 1625.46	\$ 1665.22	\$ 1700.83	\$ 1798.15	\$ 2106.87	\$ 2313.12
	Fixed	S2TC-	0-111A	A	1701.80	1742.92	1786.75	1808.70	1825.13	1864.89	1900.50	1997.82	2306.54	2512.79
	Height Adjustable	S2TC-	0-411A	A	1751.72	1792.84	1836.67	1858.62	1875.05	1914.81	1950.42	2047.74	2356.46	2562.71
	4D	S2TC-	0-711A	A	1794.14	1835.26	1879.09	1901.04	1917.47	1957.23	1992.84	2090.16	2398.88	2605.13
Back Stop/Forward Tilt	No arm	S2TC-	0-014A	A	1634.41	1675.53	1719.36	1741.31	1757.74	1797.50	1833.11	1930.43	2239.15	2445.40
	Fixed	S2TC-	0-114A	A	1834.08	1875.20	1919.03	1940.98	1957.41	1997.17	2032.78	2130.10	2438.82	2645.07
	Height Adjustable	S2TC-	0-414A	A	1884.00	1925.12	1968.95	1990.90	2007.33	2047.09	2082.70	2180.02	2488.74	2694.99
	4D	S2TC-	0-714A	A	1926.42	1967.54	2011.37	2033.32	2049.75	2089.51	2125.12	2222.44	2531.16	2737.41

\*Pricing based on Plastic base with hard casters.

# Zody II

## Task Chair

Plastic Base* Adjustments	Arm	Number		Fabric							Leather			
		①	②	A	B	C	D	E	F	G	H	A	B	
<b>Asymmetrical Lumbar Adjustment - Back Jacket</b>														
Back Stop	No arm	S2TC-	2-011A	A	\$1493.40	\$ 1575.05	\$ 1662.09	\$ 1705.66	\$ 1738.30	\$ 1817.26	\$ 1887.94	\$ 2081.20	\$2988.55	\$3488.97
	Fixed	S2TC-	2-111A	A	1693.07	1774.72	1861.76	1905.33	1937.97	2016.93	2087.61	2280.87	3188.22	3688.64
	Height Adjustable	S2TC-	2-411A	A	1742.99	1824.64	1911.68	1955.25	1987.89	2066.85	2137.53	2330.79	3238.14	3738.56
	4D	S2TC-	2-711A	A	1785.41	1867.06	1954.10	1997.67	2030.31	2109.27	2179.95	2373.21	3280.56	3780.98
Back Stop/Forward Tilt	No arm	S2TC-	2-014A	A	1625.68	1707.33	1794.37	1837.94	1870.58	1949.54	2020.22	2213.48	3120.83	3621.25
	Fixed	S2TC-	2-114A	A	1825.35	1907.00	1994.04	2037.61	2070.25	2149.21	2219.89	2413.15	3320.50	3820.92
	Height Adjustable	S2TC-	2-414A	A	1875.27	1956.92	2043.96	2087.53	2120.17	2199.13	2269.81	2463.07	3370.42	3870.84
	4D	S2TC-	2-714A	A	1917.69	1999.34	2086.38	2129.95	2162.59	2241.55	2312.23	2505.49	3412.84	3913.26
<b>PAL Back System - Mesh Back</b>														
Back Stop	No arm	S2TC-	0-021A	A	\$1373.59	\$ 1414.71	\$ 1458.54	\$ 1480.49	\$ 1496.92	\$ 1536.68	\$ 1572.29	\$ 1669.61	\$ 1978.33	\$ 2184.58
	Fixed	S2TC-	0-121A	A	1573.26	1614.38	1658.21	1680.16	1696.59	1736.35	1771.96	1869.28	2178.00	2384.25
	Height Adjustable	S2TC-	0-421A	A	1623.18	1664.30	1708.13	1730.08	1746.51	1786.27	1821.88	1919.20	2227.92	2434.17
	4D	S2TC-	0-721A	A	1665.60	1706.72	1750.55	1772.50	1788.93	1828.69	1864.30	1961.62	2270.34	2476.59
Back Stop/Forward Tilt	No arm	S2TC-	0-024A	A	1505.87	1546.99	1590.82	1612.77	1629.20	1668.96	1704.57	1801.89	2110.61	2316.86
	Fixed	S2TC-	0-124A	A	1705.54	1746.66	1790.49	1812.44	1828.87	1868.63	1904.24	2001.56	2310.28	2516.53
	Height Adjustable	S2TC-	0-424A	A	1755.46	1796.58	1840.41	1862.36	1878.79	1918.55	1954.16	2051.48	2360.20	2566.45
	4D	S2TC-	0-724A	A	1797.88	1839.00	1882.83	1904.78	1921.21	1960.97	1996.58	2093.90	2402.62	2608.87
<b>PAL Back System - Knit Back</b>														
Back Stop	No arm	S2TC-	0-021A	A	\$1538.32	\$ 1579.44	\$ 1623.27	\$ 1645.22	\$ 1661.65	\$ 1701.41	\$ 1737.02	\$ 1834.34	\$ 2143.06	\$2349.31
	Fixed	S2TC-	0-121A	A	1737.99	1779.11	1822.94	1844.89	1861.32	1901.08	1936.69	2034.01	2342.73	2548.98
	Height Adjustable	S2TC-	0-421A	A	1787.91	1829.03	1872.86	1894.81	1911.24	1951.00	1986.61	2083.93	2392.65	2598.90
	4D	S2TC-	0-721A	A	1830.33	1871.45	1915.28	1937.23	1953.66	1993.42	2029.03	2126.35	2435.07	2641.32
Back Stop/Forward Tilt	No arm	S2TC-	0-024A	A	1670.60	1711.72	1755.55	1777.50	1793.93	1833.69	1869.30	1966.62	2275.34	2481.59
	Fixed	S2TC-	0-124A	A	1870.27	1911.39	1955.22	1977.17	1993.60	2033.36	2068.97	2166.29	2475.01	2681.26
	Height Adjustable	S2TC-	0-424A	A	1920.19	1961.31	2005.14	2027.09	2043.52	2083.28	2118.89	2216.21	2524.93	2731.18
	4D	S2TC-	0-724A	A	1962.61	2003.73	2047.56	2069.51	2085.94	2125.70	2161.31	2258.63	2567.35	2773.60
<b>PAL Back System - Back Jacket</b>														
Back Stop	No arm	S2TC-	2-021A	A	\$1529.59	\$ 1611.24	\$ 1698.28	\$ 1741.85	\$ 1774.49	\$ 1853.45	\$ 1924.13	\$ 2117.39	\$3024.74	\$3525.16
	Fixed	S2TC-	2-121A	A	1729.26	1810.91	1897.95	1941.52	1974.16	2053.12	2123.80	2317.06	3224.41	3724.83
	Height Adjustable	S2TC-	2-421A	A	1779.18	1860.83	1947.87	1991.44	2024.08	2103.04	2173.72	2366.98	3274.33	3774.75
	4D	S2TC-	2-721A	A	1821.60	1903.25	1990.29	2033.86	2066.50	2145.46	2216.14	2409.40	3316.75	3817.17
Back Stop/Forward Tilt	No arm	S2TC-	2-024A	A	1661.87	1743.52	1830.56	1874.13	1906.77	1985.73	2056.41	2249.67	3157.02	3657.44
	Fixed	S2TC-	2-124A	A	1861.54	1943.19	2030.23	2073.80	2106.44	2185.40	2256.08	2449.34	3356.69	3857.11
	Height Adjustable	S2TC-	2-424A	A	1911.46	1993.11	2080.15	2123.72	2156.36	2235.32	2306.00	2499.26	3406.61	3907.03
	4D	S2TC-	2-724A	A	1953.88	2035.53	2122.57	2166.14	2198.78	2277.74	2348.42	2541.68	3449.03	3949.45

\*Pricing based on Plastic base with hard casters.

The following options require modification of the product number.

Headrest

Leather Arm Caps (Fixed arm only)

Leather Seat and Back Jacket

Faux Leather Seat and Back Jacket

Stain Repellent

To specify, change the 3rd digit to an **E** (add **\$93.28** list); **Example:** S2EC-20-714A5A

To specify, change the 7th digit to an **L** (add **\$324.47** list); **Example:** S2TC-10-L14A5A

**Note:** Leather arm caps available only when leather seat is specified. Arm cap will match seat.

To Specify, change the 6th digit to a **1**; **Example:** S2TC-11-714A5A

To Specify, change the 6th digit to a **3**; **Example:** S2TC-33-714A5A

To specify, add **P** to end of the product number (add **\$43.68** list); **Example:** S2TC-20-714A5AP

# Zody II

## Task Stool



S2TS-20-0



S2TS-20-1



S2TS-20-4



S2TS-20-7  
Class ZDI

### Features

- Back: Knit, mesh, or mesh back with upholstered back jacket.
- Seat: Upholstered with 3" (76mm) adjustable seat depth range.
- Base options:
  - Plastic standard five-star base.
  - Casters: Hard casters in black or two-tone grey; Soft casters black only.
  - Aluminum standard five-star base.
  - Casters: Hard casters in black, two-tone white or two-tone grey; Soft casters black only.
  - Aluminum base available on chairs with arms only. Not available on armless chairs.
- Arm options:
  - No arms
  - Fixed arms; Optional leather arm caps available when leather seat is specified. Leather arm caps will match seat.
  - Height Adjustable; 4" (102mm) height adjustment range.
  - 4D; 4" (102mm) height adjustment, 4" (102mm) side-to-side range, 2" (51mm) front-to-back range and pivots 20° in and 20° out.
- Arm Cap will match plastic trim color (Black or Fog). When Snow is specified, arm cap will default to Fog.
- Height adjustment: Pneumatic.
- Back Stop: Tilt stop in 6 positions.
- Lumbar adjustment options:
  - No Lumbar
  - Asymmetrical Lumbar Adjustment: 4" (102mm) height adjustment; support level can be adjusted independently for right or left hand side of user's body.
  - PAL Back System: Asymmetrical lumbar adjustment with passive pelvic support.
- COM yardage / COL square footage:
  - Upholstered back jacket: 0.75/10
  - Seat: 0.75/10

**Note:** When specifying upholstered back jacket; must also specify mesh surface color for outside back.

Upcharge for mixed grade surfaces, refer to the electronic design and specification tools.

### Dimensions

Height:	Depth:	Width:
H: 43-50.3" (1092-1278mm)	D: 29" (737mm) *SD: 16.8-19.5" (427-495mm)	W: 29" (737mm) *SW: 19.5" (495mm)
*SH: 21-28.3" (533-719mm)	(with lumbar)	
*AH: 7.6-11.6" (193-295mm)	17.5-20.2" (445-513mm)	
(Height Adjustable and 4D)	(no lumbar)	
8.5" (216mm) (Fixed)		

\*Measurements taken with the BIFMA chair measuring device.

### To Order, Specify:

1) Product number, including:

#### 1 Seat Material:

- 1 Leather
- 2 Fabric
- 3 Faux Leather

#### 2 Base/Caster Option:

##### Plastic Base

- 5 Plastic Base, Hard Caster
- 6 Plastic Base, Soft Caster (add **\$64.99** list)
- 7 Plastic Base, Two-Tone Grey Caster (add **\$26.75** list)

##### Aluminum Base

- 1 Aluminum Base, Hard Caster (add **\$112.32** list)
- 2 Aluminum Base, Soft Caster (add **\$177.31** list)
- T Aluminum Base, Two-Tone Grey Caster (add **\$139.07** list)
- W Aluminum Base, White Caster (add **\$139.07** list)

2) Seat upholstery.

3) Back upholstery (Mesh or Knit).

4) Plastic trim color.<sup>1</sup>

- TR-F Black
- TR-7 Fog (add **\$112.32** list)
- TR-UFM Snow<sup>2</sup> (add **\$187.20** list)

5) Aluminum trim color.<sup>3</sup>

- TR-BG Light Bronze<sup>4</sup>
- TR-TF Pitch
- TR-LE Metallic Silver
- TR-MC Metallic Champagne
- TR-UFS Snowfall
- PM-P Polished Aluminum

6) Base trim color.

- Plastic*
- TR-F Black
- TR-7 Fog (add **\$24.96** list)
- Aluminum*
- TR-BG Light Bronze<sup>4</sup>
- TR-TF Pitch
- TR-LE Metallic Silver
- TR-MC Metallic Champagne
- TR-UFS Snowfall (add **\$24.96** list)
- PM-P Polished Aluminum (add **\$361.91** list)

<sup>1</sup> Plastic trim color for back frame, arm caps, seat pan cover.

<sup>2</sup> When TR-UFM Snow trim is specified, arm cap will default to TR-7 Fog.

<sup>3</sup> Aluminum trim color for arm supports/uprights.

<sup>4</sup> Available on aluminum base model only.

# Zody II

## Task Stool

Plastic Base* Adjustments		Number		Fabric								Leather		
Arm		①	②	A	B	C	D	E	F	G	H	A	B	
<b>No Lumbar Adjustment - Mesh Back</b>														
Back Stop	No arm	S2TS-	0-001A	A	\$ 1537.07	\$ 1578.19	\$ 1622.02	\$ 1643.97	\$ 1660.40	\$ 1700.16	\$ 1735.77	\$ 1833.09	\$ 2141.81	\$ 2348.06
	Fixed	S2TS-	0-101A	A	1736.74	1777.86	1821.69	1843.64	1860.07	1899.83	1935.44	2032.76	2341.48	2547.73
	Height Adjustable	S2TS-	0-401A	A	1786.66	1827.78	1871.61	1893.56	1909.99	1949.75	1985.36	2082.68	2391.40	2597.65
	4D	S2TS-	0-701A	A	1829.08	1870.20	1914.03	1935.98	1952.41	1992.17	2027.78	2125.10	2433.82	2640.07
<b>No Lumbar Adjustment - Knit Back</b>														
Back Stop	No arm	S2TS-	0-001A	A	\$ 1701.80	\$ 1742.92	\$ 1786.75	\$ 1808.70	\$ 1825.13	\$ 1864.89	\$ 1900.50	\$ 1997.82	\$ 2306.54	\$ 2512.79
	Fixed	S2TS-	0-101A	A	1901.47	1942.59	1986.42	2008.37	2024.80	2064.56	2100.17	2197.49	2506.21	2712.46
	Height Adjustable	S2TS-	0-401A	A	1951.39	1992.51	2036.34	2058.29	2074.72	2114.48	2150.09	2247.41	2556.13	2762.38
	4D	S2TS-	0-701A	A	1993.81	2034.93	2078.76	2100.71	2117.14	2156.90	2192.51	2289.83	2598.55	2804.80
<b>No Lumbar Adjustment - Back Jacket</b>														
Back Stop	No arm	S2TS-	2-001A	A	\$ 1693.07	\$ 1774.72	\$ 1861.76	\$ 1905.33	\$ 1937.97	\$ 2016.93	\$ 2087.61	\$ 2280.87	\$ 3188.22	\$ 3688.64
	Fixed	S2TS-	2-101A	A	1892.74	1974.39	2061.43	2105.00	2137.64	2216.60	2287.28	2480.54	3387.89	3888.31
	Height Adjustable	S2TS-	2-401A	A	1942.66	2024.31	2111.35	2154.92	2187.56	2266.52	2337.20	2530.46	3437.81	3938.23
	4D	S2TS-	2-701A	A	1985.08	2066.73	2153.77	2197.34	2229.98	2308.94	2379.62	2572.88	3480.23	3980.65
<b>Asymmetrical Lumbar Adjustment - Mesh Back</b>														
Back Stop	No arm	S2TS-	0-011A	A	\$ 1658.12	\$ 1699.24	\$ 1743.07	\$ 1765.02	\$ 1781.45	\$ 1821.21	\$ 1856.82	\$ 1954.14	\$ 2262.86	\$ 2469.11
	Fixed	S2TS-	0-111A	A	1857.79	1898.91	1942.74	1964.69	1981.12	2020.88	2056.49	2153.81	2462.53	2668.78
	Height Adjustable	S2TS-	0-411A	A	1907.71	1948.83	1992.66	2014.61	2031.04	2070.80	2106.41	2203.73	2512.45	2718.70
	4D	S2TS-	0-711A	A	1950.13	1991.25	2035.08	2057.03	2073.46	2113.22	2148.83	2246.15	2554.87	2761.12
<b>Asymmetrical Lumbar Adjustment - Knit Back</b>														
Back Stop	No arm	S2TS-	0-011A	A	\$ 1822.85	\$ 1863.97	\$ 1907.80	\$ 1929.75	\$ 1946.18	\$ 1985.94	\$ 2021.55	\$ 2118.87	\$ 2427.59	\$ 2633.84
	Fixed	S2TS-	0-111A	A	2022.52	2063.64	2107.47	2129.42	2145.85	2185.61	2221.22	2318.54	2627.26	2833.51
	Height Adjustable	S2TS-	0-411A	A	2072.44	2113.56	2157.39	2179.34	2195.77	2235.53	2271.14	2368.46	2677.18	2883.43
	4D	S2TS-	0-711A	A	2114.86	2155.98	2199.81	2221.76	2238.19	2277.95	2313.56	2410.88	2719.60	2925.85
<b>Asymmetrical Lumbar Adjustment - Back Jacket</b>														
Back Stop	No arm	S2TS-	2-011A	A	\$ 1814.12	\$ 1895.77	\$ 1982.81	\$ 2026.38	\$ 2059.02	\$ 2137.98	\$ 2208.66	\$ 2401.92	\$ 3309.27	\$ 3809.69
	Fixed	S2TS-	2-111A	A	2013.79	2095.44	2182.48	2226.05	2258.69	2337.65	2408.33	2601.59	3508.94	4009.36
	Height Adjustable	S2TS-	2-411A	A	2063.71	2145.36	2232.40	2275.97	2308.61	2387.57	2458.25	2651.51	3558.86	4059.28
	4D	S2TS-	2-711A	A	2106.13	2187.78	2274.82	2318.39	2351.03	2429.99	2500.67	2693.93	3601.28	4101.70
<b>PAL Back System - Mesh Back</b>														
Back Stop	No arm	S2TS-	0-021A	A	\$ 1694.31	\$ 1735.43	\$ 1779.26	\$ 1801.21	\$ 1817.64	\$ 1857.40	\$ 1893.01	\$ 1990.33	\$ 2299.05	\$ 2505.30
	Fixed	S2TS-	0-121A	A	1893.98	1935.10	1978.93	2000.88	2017.31	2057.07	2092.68	2190.00	2498.72	2704.97
	Height Adjustable	S2TS-	0-421A	A	1943.90	1985.02	2028.85	2050.80	2067.23	2106.99	2142.60	2239.92	2548.64	2754.89
	4D	S2TS-	0-721A	A	1986.32	2027.44	2071.27	2093.22	2109.65	2149.41	2185.02	2282.34	2591.06	2797.31
<b>PAL Back System - Knit Back</b>														
Back Stop	No arm	S2TS-	0-021A	A	\$ 1859.04	\$ 1900.16	\$ 1943.99	\$ 1965.94	\$ 1982.37	\$ 2022.13	\$ 2057.74	\$ 2155.06	\$ 2463.78	\$ 2670.03
	Fixed	S2TS-	0-121A	A	2058.71	2099.83	2143.66	2165.61	2182.04	2221.80	2257.41	2354.73	2663.45	2869.70
	Height Adjustable	S2TS-	0-421A	A	2108.63	2149.75	2193.58	2215.53	2231.96	2271.72	2307.33	2404.65	2713.37	2919.62
	4D	S2TS-	0-721A	A	2151.05	2192.17	2236.00	2257.95	2274.38	2314.14	2349.75	2447.07	2755.79	2962.04
<b>PAL Back System - Back Jacket</b>														
Back Stop	No arm	S2TS-	2-021A	A	\$ 1850.31	\$ 1931.96	\$ 2019.00	\$ 2062.57	\$ 2095.21	\$ 2174.17	\$ 2244.85	\$ 2438.11	\$ 3345.46	\$ 3845.88
	Fixed	S2TS-	2-121A	A	2049.98	2131.63	2218.67	2262.24	2294.88	2373.84	2444.52	2637.78	3545.13	4045.55
	Height Adjustable	S2TS-	2-421A	A	2099.90	2181.55	2268.59	2312.16	2344.80	2423.76	2494.44	2687.70	3595.05	4095.47
	4D	S2TS-	2-721A	A	2142.32	2223.97	2311.01	2354.58	2387.22	2466.18	2536.86	2730.12	3637.47	4137.89

\*Pricing based on Plastic base with hard casters.

The following options require modification of the product number.

Leather Arm Caps (Fixed arm only)

To specify, change the 7th digit to an **L** (add **\$324.47** list); **Example:** S2TS-10-**L**14A5A

**Note:** Leather arm caps available only when leather seat is specified. Arm cap will match seat.

Leather Seat and Back Jacket

To Specify, change the 6th digit to a **1**; **Example:** S2TS-11-714A5A

Faux Leather Seat and Back Jacket

To Specify, change the 6th digit to a **3**; **Example:** S2TS-**33**-714A5A

Stain Repellent

To specify, add **P** to end of the product number (add **\$43.68** list); **Example:** S2TS-20-714A5A**P**

# Zody II

## Dual Posture



S2TD-20-1



S2TD-20-4



S2TD-20-7  
Class ZD1

### Features

- Back: Knit, mesh, or mesh back with upholstered back jacket.
- Seat: Upholstered with 3" (76mm) adjustable seat depth range.
- Base options:
  - Aluminum standard five-star base.
  - Casters: Hard casters in black, two-tone white or two-tone grey; Soft casters black only.
- Arm options:
  - Fixed arms; Optional leather arm caps available when leather seat is specified. Leather arm caps will match seat.
  - Height Adjustable; 4" (102mm) height adjustment range.
  - 4D; 4" (102mm) height adjustment, 4" (102mm) side-to-side range, 2" (51mm) front-to-back range and pivots 20° in and 20° out.
- Arm Cap will match plastic trim color (Black or Fog). When Snow is specified, arm cap will default to Fog.
- Height adjustment: Pneumatic.
- Back Stop/Forward Tilt; Tilt stop in 6 positions plus forward tilt 5° downward from initial position.
- Lumbar adjustment options:
  - No Lumbar
  - Asymmetrical Lumbar Adjustment: 4" (102mm) height adjustment; support level can be adjusted independently for right or left hand side of user's body.
  - PAL Back System: Asymmetrical lumbar adjustment with passive pelvic support.
- COM yardage / COL square footage:
  - Upholstered back jacket: 0.75/10
  - Seat: 0.75/10

**Note:** When specifying upholstered back jacket; must also specify mesh surface color for outside back.

Upcharge for mixed grade surfaces, refer to the electronic design and specification tools.

### Dimensions

Height:	Depth:	Width
H: 39.5-46.2" (1003-1173mm)	D: 29" (737mm)	W: 29" (737mm)
*SH: 17.5-24.2" (445-615mm)	*SD: 16.8-19.5" (427-495mm)	*SW: 19.5" (495mm)
*AH: 7.6-11.6" (193-295mm)	(with lumbar)	
(Height Adjustable and 4D)	17.5-20.2" (445-513mm)	
8.5" (216mm) (Fixed)	(no lumbar)	

\*Measurements taken with the BIFMA chair measuring device.

### To Order, Specify:

1) Product number, including:

#### 1 Seat Material:

- 1 Leather
- 2 Fabric
- 3 Faux Leather

#### 2 Base/Caster Option:

##### Aluminum Base

- 1 Aluminum Base, Hard Caster
- 2 Aluminum Base, Soft Caster (add **\$64.99** list)
- T Aluminum Base, Two-Tone Grey Caster (add **\$26.75** list)
- W Aluminum Base, White Caster (add **\$26.75** list)

2) Seat upholstery.

3) Back upholstery (Mesh or Knit).

4) Plastic trim color:<sup>1</sup>  
 TR-F Black  
 TR-7 Fog (add **\$112.32** list)  
 TR-UFM Snow<sup>2</sup> (add **\$187.20** list)

5) Aluminum trim color:<sup>3</sup>  
 TR-BG Light Bronze<sup>4</sup>  
 TR-TF Pitch  
 TR-LE Metallic Silver  
 TR-MC Metallic Champagne  
 TR-UFS Snowfall  
 PM-P Polished Aluminum

6) Base trim color.  
 TR-BG Light Bronze<sup>4</sup>  
 TR-TF Pitch  
 TR-LE Metallic Silver  
 TR-MC Metallic Champagne  
 TR-UFS Snowfall (add **\$24.96** list)  
 PM-P Polished Aluminum (add **\$361.91** list)

<sup>1</sup> Plastic trim color for back frame, arm caps, seat pan cover.

<sup>2</sup> When TR-UFM Snow trim is specified, arm cap will default to TR-7 Fog.

<sup>3</sup> Aluminum trim color for arm supports/uprights.

<sup>4</sup> Available on aluminum base model only.

# Zody II

## Dual Posture

Plastic Base* Adjustments		Number		Fabric							Leather			
Arm		①	②	A	B	C	D	E	F	G	H	A	B	
<b>No Lumbar Adjustment - Mesh Back</b>														
Back Stop/Forward Tilt	Fixed	S2TD-	0-104A	A	\$ 1910.21	\$ 1951.33	\$ 1995.16	\$ 2017.11	\$ 2033.54	\$ 2073.30	\$ 2108.91	\$ 2206.23	\$ 2514.95	\$ 2721.20
	Height Adjustable	S2TD-	0-404A	A	1960.13	2001.25	2045.08	2067.03	2083.46	2123.22	2158.83	2256.15	2564.87	2771.12
	4D	S2TD-	0-704A	A	2002.55	2043.67	2087.50	2109.45	2125.88	2165.64	2201.25	2298.57	2607.29	2813.54
<b>No Lumbar Adjustment - Knit Back</b>														
Back Stop/Forward Tilt	Fixed	S2TD-	0-104A	A	\$ 2074.94	\$ 2116.06	\$ 2159.89	\$ 2181.84	\$ 2198.27	\$ 2238.03	\$ 2273.64	\$ 2370.96	\$ 2679.68	\$ 2885.93
	Height Adjustable	S2TD-	0-404A	A	2124.86	2165.98	2209.81	2231.76	2248.19	2287.95	2323.56	2420.88	2729.60	2935.85
	4D	S2TD-	0-704A	A	2167.28	2208.40	2252.23	2274.18	2290.61	2330.37	2365.98	2463.30	2772.02	2978.27
<b>No Lumbar Adjustment - Back Jacket</b>														
Back Stop/Forward Tilt	Fixed	S2TD-	2-104A	A	\$ 2066.21	\$ 2147.86	\$ 2234.90	\$ 2278.47	\$ 2311.11	\$ 2390.07	\$ 2460.75	\$ 2654.01	\$ 3561.36	\$ 4061.78
	Height Adjustable	S2TD-	2-404A	A	2116.13	2197.78	2284.82	2328.39	2361.03	2439.99	2510.67	2703.93	3611.28	4111.70
	4D	S2TD-	2-704A	A	2158.55	2240.20	2327.24	2370.81	2403.45	2482.41	2553.09	2746.35	3653.70	4154.12
<b>Asymmetrical Lumbar Adjustment - Mesh Back</b>														
Back Stop/Forward Tilt	Fixed	S2TD-	0-114A	A	\$ 2031.26	\$ 2072.38	\$ 2116.21	\$ 2138.16	\$ 2154.59	\$ 2194.35	\$ 2229.96	\$ 2327.28	\$ 2636.00	\$ 2842.25
	Height Adjustable	S2TD-	0-414A	A	2081.18	2122.30	2166.13	2188.08	2204.51	2244.27	2279.88	2377.20	2685.92	2892.17
	4D	S2TD-	0-714A	A	2123.60	2164.72	2208.55	2230.50	2246.93	2286.69	2322.30	2419.62	2728.34	2934.59
<b>Asymmetrical Lumbar Adjustment - Knit Back</b>														
Back Stop/Forward Tilt	Fixed	S2TD-	0-114A	A	\$ 2195.99	\$ 2237.11	\$ 2280.94	\$ 2302.89	\$ 2319.32	\$ 2359.08	\$ 2394.69	\$ 2492.01	\$ 2800.73	\$ 3006.98
	Height Adjustable	S2TD-	0-414A	A	2245.91	2287.03	2330.86	2352.81	2369.24	2409.00	2444.61	2541.93	2850.65	3056.90
	4D	S2TD-	0-714A	A	2288.33	2329.45	2373.28	2395.23	2411.66	2451.42	2487.03	2584.35	2893.07	3099.32
<b>Asymmetrical Lumbar Adjustment - Back Jacket</b>														
Back Stop/Forward Tilt	Fixed	S2TD-	2-114A	A	\$ 2187.26	\$ 2268.91	\$ 2355.95	\$ 2399.52	\$ 2432.16	\$ 2511.12	\$ 2581.80	\$ 2775.06	\$ 3682.41	\$ 4182.83
	Height Adjustable	S2TD-	2-414A	A	2237.18	2318.83	2405.87	2449.44	2482.08	2561.04	2631.72	2824.98	3732.33	4232.75
	4D	S2TD-	2-714A	A	2279.60	2361.25	2448.29	2491.86	2524.50	2603.46	2674.14	2867.40	3774.75	4275.17
<b>PAL Back System - Mesh Back</b>														
Back Stop/Forward Tilt	Fixed	S2TD-	0-124A	A	\$ 2067.45	\$ 2108.57	\$ 2152.40	\$ 2174.35	\$ 2190.78	\$ 2230.54	\$ 2266.15	\$ 2363.47	\$ 2672.19	\$ 2878.44
	Height Adjustable	S2TD-	0-424A	A	2117.37	2158.49	2202.32	2224.27	2240.70	2280.46	2316.07	2413.39	2722.11	2928.36
	4D	S2TD-	0-724A	A	2159.79	2200.91	2244.74	2266.69	2283.12	2322.88	2358.49	2455.81	2764.53	2970.78
<b>PAL Back System - Knit Back</b>														
Back Stop/Forward Tilt	Fixed	S2TD-	0-124A	A	\$ 2232.18	\$ 2273.30	\$ 2317.13	\$ 2339.08	\$ 2355.51	\$ 2395.27	\$ 2430.88	\$ 2528.20	\$ 2836.92	\$ 3043.17
	Height Adjustable	S2TD-	0-424A	A	2282.10	2323.22	2367.05	2389.00	2405.43	2445.19	2480.80	2578.12	2886.84	3093.09
	4D	S2TD-	0-724A	A	2324.52	2365.64	2409.47	2431.42	2447.85	2487.61	2523.22	2620.54	2929.26	3135.51
<b>PAL Back System - Back Jacket</b>														
Back Stop/Forward Tilt	Fixed	S2TD-	2-124A	A	\$ 2223.45	\$ 2305.10	\$ 2392.14	\$ 2435.71	\$ 2468.35	\$ 2547.31	\$ 2617.99	\$ 2811.25	\$ 3718.60	\$ 4219.02
	Height Adjustable	S2TD-	2-424A	A	2273.37	2355.02	2442.06	2485.63	2518.27	2597.23	2667.91	2861.17	3768.52	4268.94
	4D	S2TD-	2-724A	A	2315.79	2397.44	2484.48	2528.05	2560.69	2639.65	2710.33	2903.59	3810.94	4311.36

The following options require modification of the product number.

Leather Arm Caps (Fixed arm only)

To specify, change the 7th digit to an **L** (add **\$324.47** list); **Example:** S2TD-10-L14A1A

**Note:** Leather arm caps available only when leather seat is specified. Arm cap will match seat.

To Specify, change the 6th digit to a **1**; **Example:** S2TD-11-714A1A

Leather Seat and Back Jacket

To Specify, change the 6th digit to a **3**; **Example:** S2TD-33-714A1A

Faux Leather Seat and Back Jacket

To specify, add **P** to end of the product number (add **\$43.68** list); **Example:** S2TD-20-714A1AP

Stain Repellent

# Zody LX

## At-A-Glance

### Designer

ITO Design and Haworth Design Studio

### Awards/ Achievements

NeoCon Silver, Best of NeoCon, Seating: Ergonomic Desk/Task, June 2022, USA

Metropolis Likes: Task Seating (winner) June 2022, USA

Greenguard Gold

Cradle to Cradle Certified Bronze

### Zody LX

A high-performing chair that blends science-based wellness and comfort with sustainability and international design.

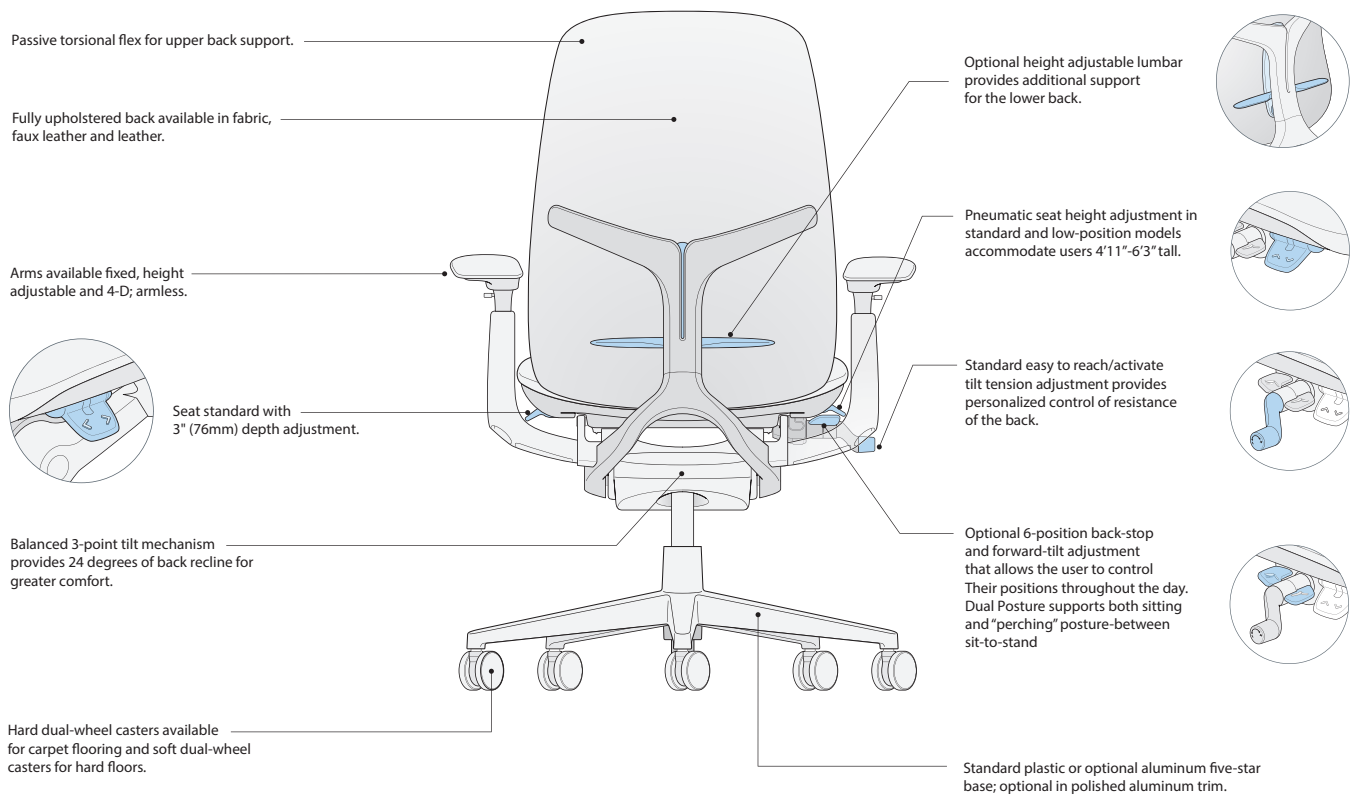

Note: Forward-tilt option NOT available on Stools

# Zody LX

## At-A-Glance

### Catalog Logic

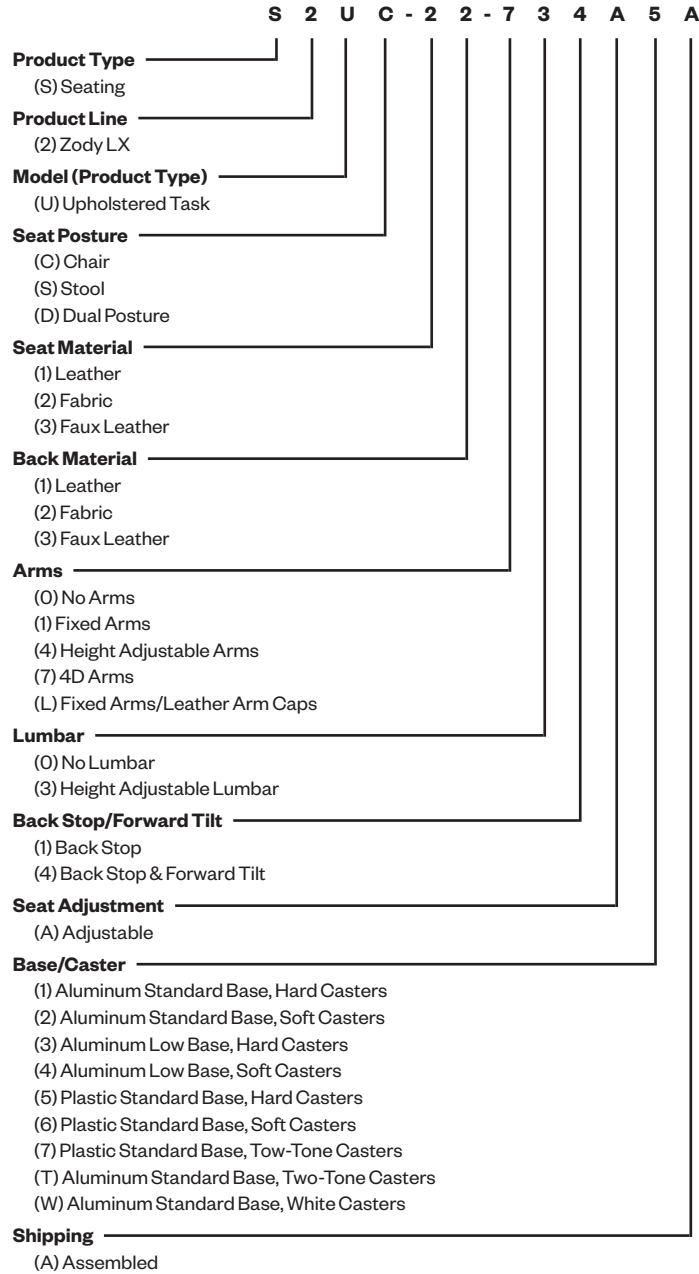

# Zody LX

## At-A-Glance

---

### Environmental Factors

- Zody LX has been evaluated for its human health, environmental health, lifecycle attributes, renewable energy, water stewardship and social responsibility characteristics against stringent certification criteria and is considered an ecologically intelligent product.
- Refer to Product Environmental Data sheet (PED) for recycled content and certifications.
- Zody LX is produced in an ISO 14001 certified manufacturing facility.
- Components are identified with ISO recycling symbols and material information to assist in the recycling effort, where practical.
- Haworth will take back Zody LX chairs after their useful life and recycle the components. Please contact Haworth's Material Recovery Center at (616)393-1215.

---

### COM & COL General Information

To order a COM fabric (Customer's Own Material), contact the Haworth Inquiry Center (1.800.426.8562), your local Haworth dealer, or go to [surfaces.haworth.com](http://surfaces.haworth.com) to find out if the COM you have selected has already been tested and approved. The surface collection site also has information on the Haworth alliance program with Carnegie, Luna Textiles, and Maharam as well as our industry-leading Pre-Approved COM program.

COM fabrics are placed into Grades based on the cost per linear yard. If a fabric's cost exceeds the range of our highest Grade it will be noted as Non-Graded. The product will be priced at Grade A; the COM fabric costs will appear as a separate line item. The fabric charge will be Haworth's purchase cost plus a 4% administrative fee (based on the cost of the fabric). Yardage calculations will include any applicable fabric repeat.

COM Leather products will be priced at a leather Grade A; COL costs will appear as a separate line item. The leather costs will be Haworth's purchase cost plus a 4% administrative fee (based on the cost of the leather).

---

### Finishes and Fabrics

For available finishes and fabrics please visit [surfaces.haworth.com](http://surfaces.haworth.com)

---

### Stain Repellent

Stain Repellent or Stain Repellent with Moisture Barrier available on fabric surfaces only.

Stain Repellent only: To specify add "**P**" to the end of the product number. Example: SZUC-22-731A5**AP**

Stain Repellent with Moisture Barrier: To specify add "**D**" to the end of the product number. Example: SZUC-22-731A5**AD**

---

### Shipping Weights (Including packaging)

- Chairs with arms: 58 pounds/1 chair per carton/19.4 cubic feet
- Chairs without arms: 52.6 pounds/1 chair per carton/19.4 cubic feet
- Dual Posture with arms: 60.6 pounds/1 chair per carton/22.1 cubic feet
- Dual Posture without arms: 55.2 pounds/1 chair per carton/22.1 cubic feet
- Stool with arms: 61 pounds/1 stool per carton/22.1 cubic feet
- Stool without arms: 55.6 pounds/1 stool per carton/22.1 cubic feet

---

### Specifications

Task chairs and stools designed for use by individuals up to 350 lbs.\*

\* Task chairs with forward tilt are designed for use by individuals up to 325lbs.  
Select configurations are available for use by individuals up to 400lbs.

# Zody LX

## At-A-Glance — Standard Mobility and Adjustability

### Balanced 3-point Tilt



#### Features

- Balanced 3-point tilt mechanism.
- Back reclines 24° from the upright position.
- Seat pan moves downward 3° from the initial position.

#### Benefits

- Comfortable relaxed posture.
- Recline allows for the opening of the users' chest cavity providing good airflow to promote alertness.
- Users' feet remain flat.

### Tilt Tension Control

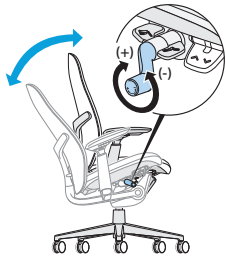

#### Feature

- Easy-to-reach and easy-to-activate side-mounted tilt tension control regulates the amount of resistance felt when leaning back in the chair and the effort required to recline the chair backwards.

#### Benefit

- Personalized support to accommodate users of different body types and different work styles.

### Seat Height Adjustment

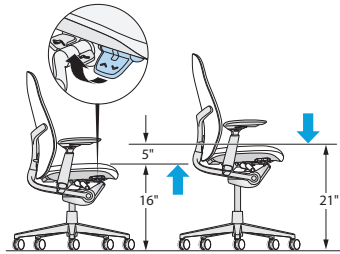

Fully Retracted

Fully Extended

#### Features

- Pneumatic seat height adjustment.
- Task chair seat height adjusts 5" (127mm) from 16" to 21" (406mm to 533mm) in standard models. Low-position adjusts 14.7" to 18" (373 to 457mm).
- Task stool seat height adjusts 7.3" (185mm) from 21" to 28.3" (533mm to 719mm).
- Dual Posture adjusts 17.5" to 24.2" (445mm to 615mm).

#### Benefits

- Ensures the comfort of the lower limbs by avoiding pressure on the underside of the thigh caused by a seat pan that is too high, or decreased thigh-to-torso angle if the seat pan is too low.
- Accommodates for users between approximately 4'11" (1499mm) and 6'3" (1905mm) tall to provide good leg circulation.
- Seat height adjustment also is important in setting the proper hand position and allowing for a proper sitting eye height.

### Seat Depth Adjustment

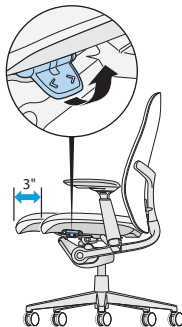

#### Features

- 3" (76mm) of seat depth range.
- Waterfall edge.

#### Benefit

- Supports the thighs, allows users to rest against the seat back for back support, and avoids pressure on the back of the knees of small to tall users.

# Zody LX

## At-A-Glance — Optional Mobility and Adjustability

### Lumbar

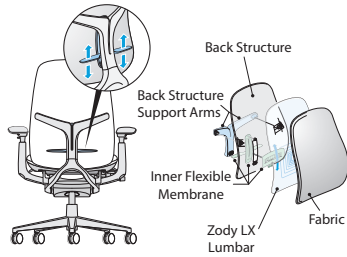

#### Features

- Optional height adjustable lumbar.
- Range of 4" (102mm) of height adjustment.

#### Benefit

- Lumbar adjustment maintains the natural curvature of the spine at the lower back and allows users to choose the support that feels right for them

### 4D Arm

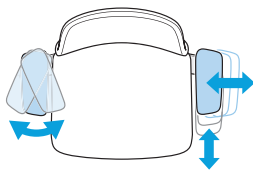

#### Features

- Optional 4D arm.
- Arm adjusts in 4 ways:
  - Height adjustment: 4" (102mm)
  - Side-to-side arm cap adjustment range: 4" (102mm) [2" (51mm) each arm cap]
  - Front-to-back adjustment range: 2" (51mm)
  - Pivoting: In 20°; out 20°

#### Benefits

- Arms support the muscular system of users' neck and shoulders and proper arm support provides back relief. Arms can be an aid in standing or sitting down.
- Height adjustment accommodates for users with varying elbow rest heights so that users avoid lifting their shoulders or leaning sideways to get arm support.
- Front-to-back adjustment adjusts the armrest length, which is important because it allows users to get close to the worksurface while maintaining the effective use of the backrest.
- Side-to-side adjustment ensures a comfortable resting position for the arms with proper support of the forearm while allowing for easy entry/exit of the chair.
- Pivoting provides proper support of the forearm when performing tasks involving keying and mousing.

### Adjustable Height Arm

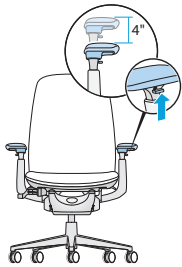

#### Feature

- Optional height adjustable arms adjust 4" (102mm) vertically.

#### Benefit

- Height adjustment accommodates users with varying elbow rest heights so that users avoid lifting their shoulders or leaning sideways to get arm support.

### Back Stop

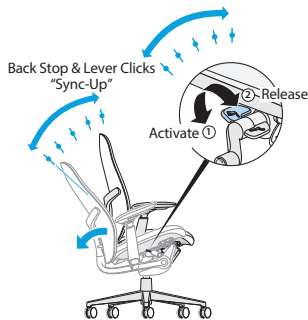

#### Feature

- Optional back stop;
  - Back stops in 6 positions - upright and every 4° backward.

#### Benefit

- Allows users the choice of selecting an upright position or limiting the amount of recline while performing different tasks.

# Zody LX

## At-A-Glance — Optional Mobility and Adjustability

### Back Stop/ Forward Tilt

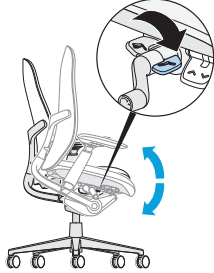

#### Features

- Optional back-stop and forward tilt.
- Back stops in 6 positions, upright and every 4° backward.
- Seat pan moves downward 5° from the initial position.

#### Benefits

- Allows users to sit forward in the chair for task intensive work.
- Allows users to vary their posture for maximum comfort and for changes in task requirements.

**Note:** Not available on task stool.

### Dual Posture

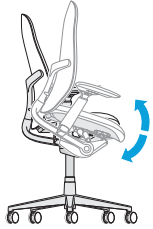

#### Features

- Increased seat height range of 17.5"(445mm)-24.2"(615mm).
- Seat pan moves downward 5° from initial position with an increased degree of forward tilt.

#### Benefit

- Promotes the in-between "perch" posture of sit-to-stand. Ideal for use with a height adjustable table.

### Base

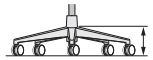
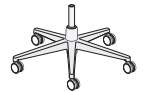

Standard Plastic Base

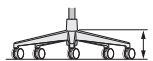

Optional Aluminum Base

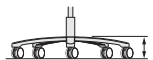
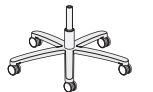

Low Position Base  
(Aluminum only)

#### Colors

- TR-F Black
- TR-7 Fog

**Note:** When plastic base is specified all metal trim defaults to base color.

#### Casters

Hard casters in Black or Two-Tone Grey.  
Soft casters in Black.

#### Colors

- TR-BG Light Bronze
- TR-TF Pitch
- TR-LE Metallic Silver
- TR-MC Metallic Champagne
- TR-UFS Snowfall
- PM-P Polished Aluminum

#### Casters

Hard casters in Black, Two-Tone White or Two-Tone Grey.  
Soft casters in Black.

#### Colors

- TR-BG Light Bronze
- TR-TF Pitch
- TR-LE Metallic Silver
- TR-MC Metallic Champagne
- TR-UFS Snowfall

#### Casters

Soft casters in Black.

### Ergonomic Standards Guidelines

- All Zody LX models meet or exceed all ANSI/BIFMA durability standards for office seating.
- Zody LX meets the following ergonomic standards/guidelines:
  - BSR/HFES 100-2002
  - BIFMA G1-2002
  - CSA-Z412-2000
  - CAN/CGSB 44.232-2002
  - HFES 2007

# Zody LX

## Task Chair



S2UC-22-0



S2UC-22-1



S2UC-22-4



S2UC-22-7

Class ZD1

### Features

- Back: Fully upholstered.
- Seat: Upholstered with 3" (76mm) adjustable seat depth range.
- Base options:
  - Plastic standard five-star base. Casters: Hard casters in black or two-tone grey; Soft casters black only.
  - Aluminum standard five-star base. Casters: Hard casters in black, two-tone white or two-tone grey; Soft casters black only.
  - Aluminum low-position five-star base. Not available in PM-P Polished Aluminum. Casters: Hard or soft casters in black only.
  - Aluminum base available on chairs with arms only. Not available on armless chairs.
- Arm options:
  - No arms
  - Fixed arms; Optional leather arm caps available when leather seat is specified. Leather arm caps will match seat.
  - Height Adjustable; 4" (102mm) height adjustment range.
  - 4D; 4" (102mm) height adjustment, 4" (102mm) side-to-side range, 2" (51mm) front-to-back range and pivots 20° in and 20° out.
- Arm Cap will match plastic trim color (Black or Fog). When Snow is specified, arm cap will default to Fog.
- Height adjustment: Pneumatic or low-position pneumatic.
- Back Stop: Tilt stop in 6 positions.
- Back Stop/Forward Tilt; Tilt stop in 6 positions plus forward tilt 5° downward from initial position.
- Lumbar adjustment options:
  - No Lumbar
  - Height Adjustable Lumbar: 4" (102mm) height adjustment.
- COM yardage / COL square footage:
  - Back: 0.80/12
  - Seat: 0.75/10

Upcharge for mixed grade surfaces, refer to the electronic design and specification tools.

### Dimensions

Height:	Depth:	Width:
H: 38.8-43.8" (986-1113mm) (Std. base)	D: 29" (737mm) *SD: 16.4-19.4" (417-493mm)	W: 29" (737mm) *SW: 19.5" (495mm)
37.5-40.8" (953-1036mm) (Low base)		
*SH: 16-21" (406-533mm) (Std. base)		
14.7-18" (373-457mm) (Low base)		
*AH: 7.6-11.6" (193-295mm) (Height Adjustable and 4D)		
8.5" (216mm) (Fixed)		

\*Measurements taken with the BIFMA chair measuring device.

### To Order, Specify:

1) Product number, including:

#### 1 Seat Material:

- 1 Leather
- 2 Fabric
- 3 Faux Leather

#### 2 Back Material:

- 1 Leather
- 2 Fabric
- 3 Faux Leather

#### 3 Base/Caster Option:

##### Plastic Base

- 5 Plastic Base, Hard Caster
- 6 Plastic Base, Soft Caster (add **\$64.99** list)
- 7 Plastic Base, Two-Tone Grey Caster (add **\$26.75** list)

##### Aluminum Base

- 1 Aluminum Base, Hard Caster (add **\$112.32** list)
- 2 Aluminum Base, Soft Caster (add **\$177.31** list)
- T Aluminum Base, Two-Tone Grey Caster (add **\$139.07** list)
- W Aluminum Base, White Caster (add **\$139.07** list)

##### Low Base - Aluminum

- 3 Aluminum Low Base, Hard Caster (add **\$112.32** list)
- 4 Aluminum Low Base, Soft Caster (add **\$177.31** list)

- 2) Seat upholstery.
- 3) Back upholstery.
- 4) Plastic trim color:<sup>1</sup>
  - TR-F Black
  - TR-7 Fog (add **\$112.32** list)
  - TR-UFM Snow<sup>2</sup> (add **\$187.20** list)
- 5) Aluminum trim color:<sup>3</sup>
  - TR-BG Light Bronze<sup>4</sup>
  - TR-TF Pitch
  - TR-LE Metallic Silver
  - TR-MC Metallic Champagne
  - TR-UFS Snowfall
  - PM-P Polished Aluminum
- 6) Base trim color.
  - Plastic*
    - TR-F Black
    - TR-7 Fog (add **\$24.96** list)
  - Aluminum*
    - TR-BG Light Bronze<sup>4</sup>
    - TR-TF Pitch
    - TR-LE Metallic Silver
    - TR-MC Metallic Champagne
    - TR-UFS Snowfall (add **\$24.96** list)
    - PM-P Polished Aluminum (add **\$361.91** list)

<sup>1</sup> Plastic trim color for Y-brace, arm caps, seat pan cover.

<sup>2</sup> When TR-UFM Snow trim is specified, arm cap and head rest will default to TR-7 Fog.

<sup>3</sup> Aluminum trim color for back support, arm supports/uprights.

<sup>4</sup> Available on aluminum base model only.

# Zody LX

## Task Chair

Plastic Base* Adjustments	Arm	Number			Fabric								Leather	
		①	②	③	A	B	C	D	E	F	G	H	A	B
<b>No Lumbar Adjustment</b>														
Back Stop	No arm	S2UC-	-001A	A	\$ 1313.48	\$1406.00	\$ 1504.62	\$ 1554.00	\$ 1590.99	\$ 1680.44	\$ 1760.55	\$ 1979.50	\$2808.63	\$3309.05
	Fixed	S2UC-	-101A	A	1513.15	1605.67	1704.29	1753.67	1790.66	1880.11	1960.22	2179.17	3008.30	3508.72
	Height Adjustable	S2UC-	-401A	A	1563.07	1655.59	1754.21	1803.59	1840.58	1930.03	2010.14	2229.09	3058.22	3558.64
	4D	S2UC-	-701A	A	1605.49	1698.01	1796.63	1846.01	1883.00	1972.45	2052.56	2271.51	3100.64	3601.06
Back Stop/Forward Tilt	No arm	S2UC-	-004A	A	1445.76	1538.28	1636.90	1686.28	1723.27	1812.72	1892.83	2111.78	2940.91	3441.33
	Fixed	S2UC-	-104A	A	1645.43	1737.95	1836.57	1885.95	1922.94	2012.39	2092.50	2311.45	3140.58	3641.00
	Height Adjustable	S2UC-	-404A	A	1695.35	1787.87	1886.49	1935.87	1972.86	2062.31	2142.42	2361.37	3190.50	3690.92
	4D	S2UC-	-704A	A	1737.77	1830.29	1928.91	1978.29	2015.28	2104.73	2184.84	2403.79	3232.92	3733.34
<b>Height Adjustable Lumbar</b>														
Back Stop	No arm	S2UC-	-031A	A	\$1434.53	\$ 1527.05	\$ 1625.67	\$ 1675.05	\$ 1712.04	\$ 1801.49	\$ 1881.60	\$ 2100.55	\$ 2929.68	\$3430.10
	Fixed	S2UC-	-131A	A	1634.20	1726.72	1825.34	1874.72	1911.71	2001.16	2081.27	2300.22	3129.35	3629.77
	Height Adjustable	S2UC-	-431A	A	1684.12	1776.64	1875.26	1924.64	1961.63	2051.08	2131.19	2350.14	3179.27	3679.69
	4D	S2UC-	-731A	A	1726.54	1819.06	1917.68	1967.06	2004.05	2093.50	2173.61	2392.56	3221.69	3722.11
Back Stop/Forward Tilt	No arm	S2UC-	-034A	A	1566.81	1659.33	1757.95	1807.33	1844.32	1933.77	2013.88	2232.83	3061.96	3562.38
	Fixed	S2UC-	-134A	A	1766.48	1859.00	1957.62	2007.00	2043.99	2133.44	2213.55	2432.50	3261.63	3762.05
	Height Adjustable	S2UC-	-434A	A	1816.40	1908.92	2007.54	2056.92	2093.91	2183.36	2263.47	2482.42	3311.55	3811.97
	4D	S2UC-	-734A	A	1858.82	1951.34	2049.96	2099.34	2136.33	2225.78	2305.89	2524.84	3353.97	3854.39

\*Pricing based on Plastic base with hard casters.

The following options require modification of the product number.

Leather Arm Caps (Fixed arm only)

To specify, change the 7th digit to an **L** (add **\$324.47** list); **Example:** S2UC-11-L04A5A

**Note:** Leather arm caps available only when leather seat is specified. Arm cap will match seat.

Stain Repellent

To specify, add **P** to end of the product number (add **\$43.68** list); **Example:** S2UC-22-731A5AP

# Zody LX

## Task Stool



S2US-22-0



S2US-22-1



S2US-22-4



S2US-22-7  
Class ZD1

### Features

- Back: Fully upholstered.
- Seat: Upholstered with 3"(76mm) adjustable seat depth range.
- Base options:
  - Plastic standard five-star base.
  - Casters: Hard casters in black or two-tone grey; Soft casters black only.
  - Aluminum standard five-star base.
  - Casters: Hard casters in black, two-tone white or two-tone grey; Soft casters black only.
  - Aluminum base available on chairs with arms only. Not available on armless chairs.
- Arm options:
  - No arms
  - Fixed arms; Optional leather arm caps available when leather seat is specified. Leather arm caps will match seat.
  - Height Adjustable; 4"(102mm) height adjustment range.
  - 4D; 4"(102mm) height adjustment, 4"(102mm) side-to-side range, 2"(51mm) front-to-back range and pivots 20° in and 20° out.
- Arm Cap will match plastic trim color (Black or Fog). When Snow is specified, arm cap will default to Fog.
- Height adjustment: Pneumatic.
- Back Stop: Tilt stop in 6 positions.
- Lumbar adjustment options:
  - No Lumbar
  - Height Adjustable Lumbar: 4"(102mm) height adjustment.
- COM yardage / COL square footage:
  - Back: 0.80/12
  - Seat: 0.75/10

Upcharge for mixed grade surfaces, refer to the electronic design and specification tools.

### Dimensions

Height:	Depth:	Width:
H: 43.8-51.1" (1113-1298mm)	D: 29"(737mm) *SD: 16.4-19.4" (417-493mm)	W: 29"(737mm) *SW: 19.5"(495mm)
*SH: 21-28.3" (533-719mm)		
*AH: 7.6-11.6" (193-295mm) (Height Adjustable and 4D) 8.5"(216mm) (Fixed)		

\*Measurements taken with the BIFMA chair measuring device.

### To Order, Specify:

1) Product number, including:

#### 1 Seat Material:

- 1 Leather
- 2 Fabric
- 3 Faux Leather

#### 2 Back Material:

- 1 Leather
- 2 Fabric
- 3 Faux Leather

#### 3 Base/Caster Option:

##### Plastic Base

- 5 Plastic Base, Hard Caster
- 6 Plastic Base, Soft Caster (add **\$64.99** list)
- 7 Plastic Base, Two-Tone Grey Caster (add **\$26.75** list)

##### Aluminum Base

- 1 Aluminum Base, Hard Caster (add **\$112.32** list)
- 2 Aluminum Base, Soft Caster (add **\$177.31** list)
- T Aluminum Base, Two-Tone Grey Caster (add **\$139.07** list)
- W Aluminum Base, White Caster (add **\$139.07** list)

2) Seat upholstery.

3) Back upholstery.

4) Plastic trim color.<sup>1</sup>

- TR-F Black
- TR-7 Fog (add **\$112.32** list)
- TR-UFM Snow<sup>2</sup> (add **\$187.20** list)

5) Aluminum trim color.<sup>3</sup>

- TR-BG Light Bronze<sup>4</sup>
- TR-TF Pitch
- TR-LE Metallic Silver
- TR-MC Metallic Champagne
- TR-UFS Snowfall
- PM-P Polished Aluminum

6) Base trim color.

##### Plastic

- TR-F Black
- TR-7 Fog (add **\$24.96** list)

##### Aluminum

- TR-BG Light Bronze<sup>4</sup>
- TR-TF Pitch
- TR-LE Metallic Silver
- TR-MC Metallic Champagne
- TR-UFS Snowfall (add **\$24.96** list)
- PM-P Polished Aluminum (add **\$361.91** list)

<sup>1</sup> Plastic trim color for Y-brace, arm caps, seat pan cover.

<sup>2</sup> When TR-UFM Snow trim is specified, arm cap will default to TR-7 Fog.

<sup>3</sup> Aluminum trim color for back support, arm supports/uprights.

<sup>4</sup> Available on aluminum base model only.

# Zody LX

## Task Stool

Plastic Base* Adjustments	Arm	Number		Fabric								Leather		
		①	②	A	B	C	D	E	F	G	H	A	B	
<b>No Lumbar Adjustment</b>														
Back Stop	No arm	S2US-	-001A	A	\$ 1634.20	\$ 1726.72	\$ 1825.34	\$ 1874.72	\$ 1911.71	\$ 2001.16	\$ 2081.27	\$ 2300.22	\$ 3129.35	\$ 3629.77
	Fixed	S2US-	-101A	A	1833.87	1926.39	2025.01	2074.39	2111.38	2200.83	2280.94	2499.89	3329.02	3829.44
	Height Adjustable	S2US-	-401A	A	1883.79	1976.31	2074.93	2124.31	2161.30	2250.75	2330.86	2549.81	3378.94	3879.36
	4D	S2US-	-701A	A	1926.21	2018.73	2117.35	2166.73	2203.72	2293.17	2373.28	2592.23	3421.36	3921.78
<b>Height Adjustable Lumbar</b>														
Back Stop	No arm	S2US-	-031A	A	\$ 1755.25	\$ 1847.77	\$ 1946.39	\$ 1995.77	\$ 2032.76	\$ 2122.21	\$ 2202.32	\$ 2421.27	\$ 3250.40	\$ 3750.82
	Fixed	S2US-	-131A	A	1954.92	2047.44	2146.06	2195.44	2232.43	2321.88	2401.99	2620.94	3450.07	3950.49
	Height Adjustable	S2US-	-431A	A	2004.84	2097.36	2195.98	2245.36	2282.35	2371.80	2451.91	2670.86	3499.99	4000.41
	4D	S2US-	-731A	A	2047.26	2139.78	2238.40	2287.78	2324.77	2414.22	2494.33	2713.28	3542.41	4042.83

\*Pricing based on Plastic base with hard casters.

The following options require modification of the product number.

Leather Arm Caps (Fixed arm only)

To specify, change the 7th digit to an **L** (add **\$324.47** list); **Example:** S2US-11-**L**31A5A

Stain Repellent

**Note:** Leather arm caps available only when leather seat is specified. Arm cap will match seat.  
To specify, add **P** to end of the product number (add **\$43.68** list); **Example:** S2US-22-701A5**AP**

# Zody LX

## Dual Posture



S2UD-22-1



S2UD-22-4



S2UD-22-7  
Class ZD1

### Features

- Back: Fully upholstered.
- Seat: Upholstered with 3"(76mm) adjustable seat depth range.
- Base options:
  - Aluminum standard five-star base.
  - Casters: Hard casters in black, two-tone white or two-tone grey; Soft casters black only.
- Arm options:
  - Fixed arms; Optional leather arm caps available when leather seat is specified. Leather arm caps will match seat.
  - Height Adjustable; 4"(102mm) height adjustment range.
  - 4D; 4"(102mm) height adjustment, 4"(102mm) side-to-side range, 2"(51mm) front-to-back range and pivots 20° in and 20° out.
- Arm Cap will match plastic trim color (Black or Fog). When Snow is specified, arm cap will default to Fog.
- Height adjustment: Pneumatic.
- Back Stop/Forward Tilt; Tilt stop in 6 positions plus forward tilt 5° downward from initial position.
- Lumbar adjustment options:
  - No Lumbar
  - Height Adjustable Lumbar: 4"(102mm) height adjustment.
- COM yardage / COL square footage:
  - Back: 0.80/12
  - Seat: 0.75/10

Upcharge for mixed grade surfaces, refer to the electronic design and specification tools.

### Dimensions

Height:	Depth:	Width:
H: 40.3-47" (1024-1194mm)	D: 29"(737mm) *SD: 16.4-19.4" (417-493mm)	W: 29"(737mm) *SW: 19.5"(495mm)
*SH: 17.5-24.2" (445-615mm)		
*AH: 7.6-11.6" (193-295mm) (Height Adjustable and 4D) 8.5"(216mm) (Fixed)		

\*Measurements taken with the BIFMA chair measuring device.

### To Order, Specify:

1) Product number, including:

#### 1 Seat Material:

- 1 Leather
- 2 Fabric
- 3 Faux Leather

#### 2 Back Material:

- 1 Leather
- 2 Fabric
- 3 Faux Leather

#### 3 Base/Caster Option:

##### Aluminum Base

- 1 Aluminum Base, Hard Caster
- 2 Aluminum Base, Soft Caster (add **\$64.99** list)
- T Aluminum Base, Two-Tone Grey Caster (add **\$26.75** list)
- W Aluminum Base, White Caster (add **\$26.75** list)

2) Seat upholstery.

3) Back upholstery.

4) Plastic trim color:<sup>1</sup>

- TR-F Black
- TR-7 Fog (add **\$112.32** list)
- TR-UFM Snow<sup>2</sup> (add **\$187.20** list)

5) Aluminum trim color:<sup>3</sup>

- TR-BG Light Bronze<sup>4</sup>
- TR-TF Pitch
- TR-LE Metallic Silver
- TR-MC Metallic Champagne
- TR-UFS Snowfall
- PM-P Polished Aluminum

6) Base trim color.

- TR-BG Light Bronze<sup>4</sup>
- TR-TF Pitch
- TR-LE Metallic Silver
- TR-MC Metallic Champagne
- TR-UFS Snowfall (add **\$24.96** list)
- PM-P Polished Aluminum (add **\$361.91** list)

<sup>1</sup> Plastic trim color for Y-brace, arm caps, seat pan cover.

<sup>2</sup> When TR-UFM Snow trim is specified, arm cap will default to TR-7 Fog.

<sup>3</sup> Aluminum trim color for back support, arm supports/uprights.

<sup>4</sup> Available on aluminum base model only.

# Zody LX

## Dual Posture

Adjustments	Arm	Number			Fabric								Leather	
		①	②	③	A	B	C	D	E	F	G	H	A	B
<b>No Lumbar Adjustment</b>														
Back Stop/Forward Tilt	Fixed	S2UD-	-104A	A	\$2007.34	\$2099.86	\$2198.48	\$2247.86	\$2284.85	\$2374.30	\$2454.41	\$2673.36	\$3502.49	\$4002.91
	Height Adjustable	S2UD-	-404A	A	2057.26	2149.78	2248.40	2297.78	2334.77	2424.22	2504.33	2723.28	3552.41	4052.83
	4D	S2UD-	-704A	A	2099.68	2192.20	2290.82	2340.20	2377.19	2466.64	2546.75	2765.70	3594.83	4095.25
<b>Height Adjustable Lumbar Adjustment</b>														
Back Stop/Forward Tilt	Fixed	S2UD-	-134A	A	\$2128.39	\$2220.91	\$2319.53	\$2368.91	\$2405.90	\$2495.35	\$2575.46	\$2794.41	\$3623.54	\$4123.96
	Height Adjustable	S2UD-	-434A	A	2178.31	2270.83	2369.45	2418.83	2455.82	2545.27	2625.38	2844.33	3673.46	4173.88
	4D	S2UD-	-734A	A	2220.73	2313.25	2411.87	2461.25	2498.24	2587.69	2667.80	2886.75	3715.88	4216.30

The following options require modification of the product number.

Leather Arm Caps (Fixed arm only)

To specify, change the 7th digit to an **L** (add **\$324.47** list); **Example:** S2UD-11-L04A1A

**Note:** Leather arm caps available only when leather seat is specified. Arm cap will match seat.

Stain Repellent

To specify, add **P** to end of the product number (add **\$43.68** list); **Example:** S2UD-22-704A1AP

# Zody

## At-A-Glance

**Designer** ITO Design and Haworth Design Studio

**Awards/Achievements** NeoCon Silver, Best of NeoCon, Seating: Ergonomic Desk/Task, June 2005, USA  
 IIDEX/NeoCon Gold, Seating: Desk/Workstation Chairs, September 2005, Canada  
 BIFMA level 3 certified.

**Zody** A high-performing chair that blends science-based wellness and comfort with sustainability and international design.

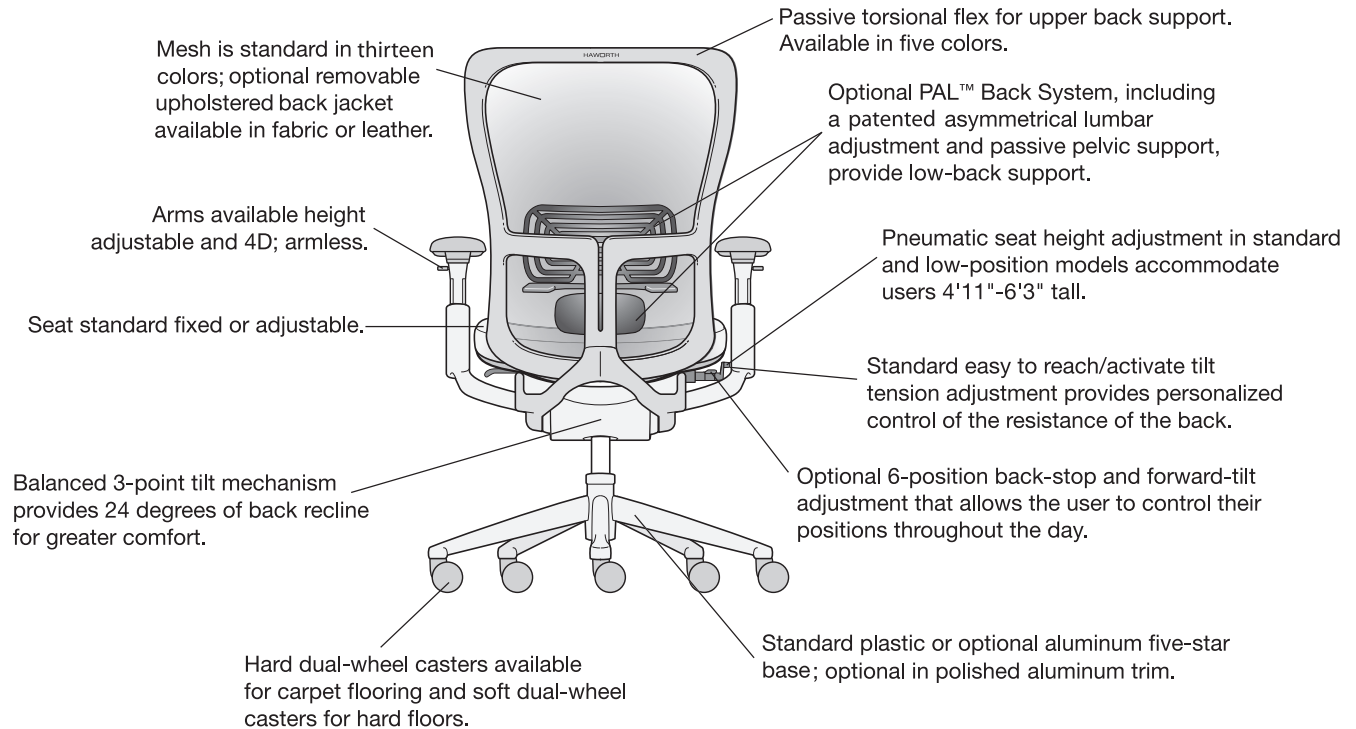

**Note:** Forward-tilt option not available on Stool.

# Zody

## At-A-Glance

### Catalog Logic

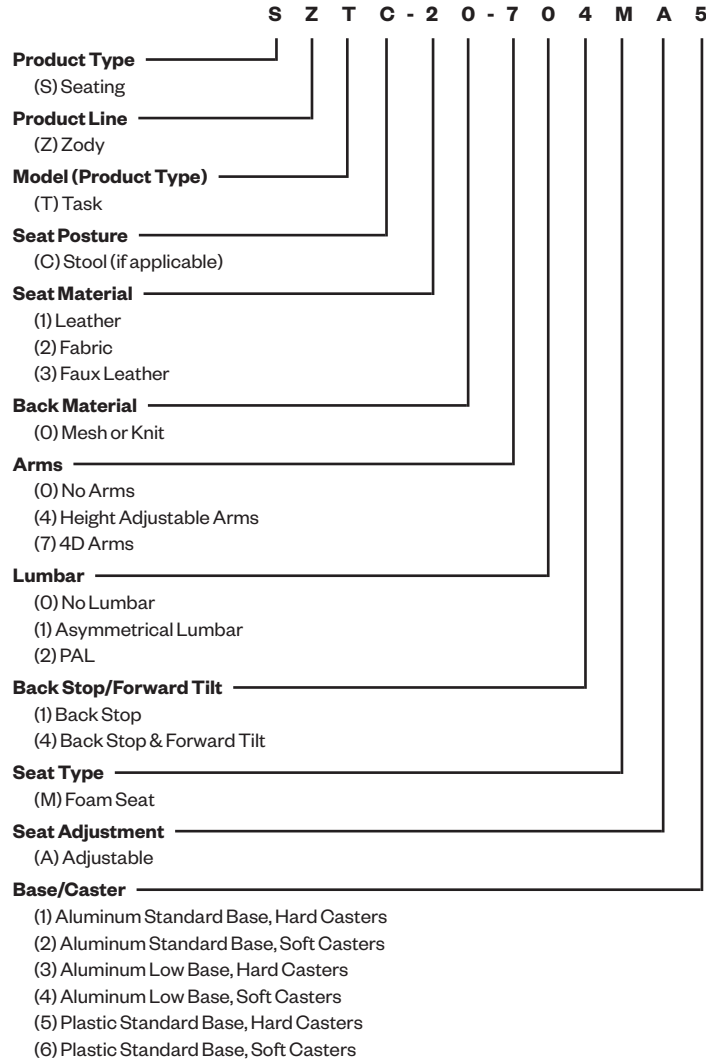

# Zody

## At-A-Glance

### Environmental Factors

- Zody has been evaluated for its human health, environmental health, lifecycle attributes, renewable energy, water stewardship and social responsibility characteristics against stringent certification criteria and is considered an ecologically intelligent product.
- Refer to Product Environmental Data sheet (PED) for recycled content and certifications.
- Zody is produced in an ISO 14001 certified manufacturing facility.
- Components are identified with ISO recycling symbols and material information to assist in the recycling effort, where practical.
- Haworth will take back Zody chairs after their useful life and recycle the components. Please contact Haworth's Material Recovery Center at (616)393-1215.
- Optional Trivalent chrome finish provides safer and more environmentally friendly alternative for customers requiring the attributes of a chrome finish.

### COM & COL General Information

To order a COM fabric (Customer's Own Material), contact the Haworth Inquiry Center (1.800.426.8562), your local Haworth dealer, or go to [surfaces.haworth.com](http://surfaces.haworth.com) to find out if the COM you have selected has already been tested and approved. The surface collection site also has information on the Haworth alliance program with Carnegie, Luna Textiles, and Maharam as well as our industry-leading Pre-Approved COM program.

COM fabrics are placed into Grades based on the cost per linear yard. If a fabric's cost exceeds the range of our highest Grade it will be noted as Non-Graded. The product will be priced at Grade A; the COM fabric costs will appear as a separate line item. The fabric charge will be Haworth's purchase cost plus a 4% administrative fee (based on the cost of the fabric). Yardage calculations will include any applicable fabric repeat.

COM Leather products will be priced at a leather Grade A; COL costs will appear as a separate line item. The leather costs will be Haworth's purchase cost plus a 4% administrative fee (based on the cost of the leather).

### Finishes and Fabrics

A complete listing of finishes and fabrics for Zody seating is available in the back of the price list.

### Shipping Weights (Including packaging)

- Chairs with arms: 55 pounds/1 chair per carton/17.3 cubic feet
- Chairs without arms: 51 pounds/1 chair per carton/17.3 cubic feet
- Chairs with sled base: 24 pounds/1 chair per carton/17.3 cubic feet
- Chairs with leg base: 21 pounds/1 chair per carton/17.3 cubic feet
- Stool with arms: 58 pounds/1 stool per carton/21.5 cubic feet
- Stool without arms: 54 pounds/1 stool per carton/21.5 cubic feet

### Stain Repellent

Stain Repellent or Stain Repellent with Moisture Barrier available on fabric surfaces only.

Stain Repellent only: To specify add "P" to the end of the product number. Example: SZT-22-702MA1**P**

Stain Repellent with Moisture Barrier: To specify add "D" to the end of the product number. Example: SZT-22-702MA1**D**

### Specifications

Task chair and task stool designed for use by individuals up to 325 lbs.

# Zody

## At-A-Glance — Standard Mobility and Adjustability

### Balanced 3-point Tilt

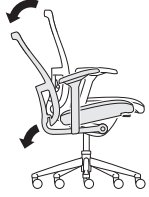

#### Features

- Balanced 3-point tilt mechanism.
- Back reclines 24° from the upright position.
- Seat pan moves downward 3° from the initial position.

#### Benefits

- Comfortable relaxed posture.
- Recline allows for the opening of the users' chest cavity providing good airflow to promote alertness.
- Users' feet remain flat.

### Tilt Tension Control

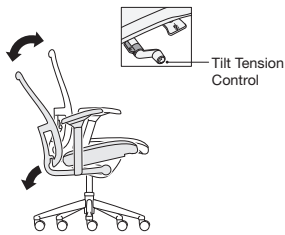

#### Feature

- Easy-to-reach and easy-to-activate side-mounted tilt tension control regulates the amount of resistance felt when leaning back in the chair and the effort required to recline the chair backwards.

#### Benefit

- Personalized support to accommodate users of different body types and different work styles.

### Seat Height Adjustment

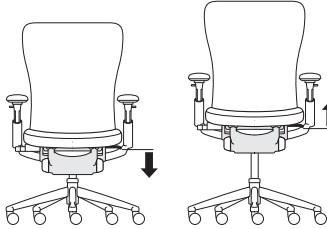

Fully Retracted

Fully Extended

#### Features

- Pneumatic seat height adjustment.
- Task chair seat height adjusts 5" (127mm) from 16" to 21" (406mm to 533mm) in standard models. Low-position adjusts 14" to 17" (356 to 432mm).
- Task stool seat height adjusts 7.5" (191mm) from 21.5" to 29" (546mm to 737mm).

#### Benefits

- Ensures the comfort of the lower limbs by avoiding pressure on the underside of the thigh caused by a seat pan that is too high, or decreased thigh-to-torso angle if the seat pan is too low.
- Accommodates for users between approximately 4'11" (1499mm) and 6'3" (1905mm) tall to provide good leg circulation.
- Seat height adjustment also is important in setting the proper hand position and allowing for a proper sitting eye height.

### Seat Depth Adjustment

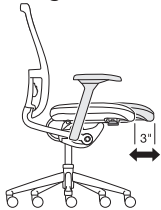

#### Features

- 3" (76mm) of seat depth range. (Fixed seat also available.)
- Available with conventional foam material.
- Waterfall edge.

#### Benefit

- Supports the thighs, allows users to rest against the seat back for back support, and avoids pressure on the back of the knees of small to tall users.

### Upper Back Torsional Movement



#### Features

- Passive 2" (51mm) of torsional flex in the upper back.
- Patented mesh with built in tension zones for added comfort.

#### Benefit

- Increases users' mobility and comfort when reaching sideways for objects.

# Zody

## At-A-Glance — Optional Mobility and Adjustability

### PAL Back System



#### Features

- PAL Back System includes Asymmetrical Lumbar Adjustment and passive pelvic support.
- Asymmetrical Lumbar Adjustment adjusts 4"(102mm) in height; support level can be adjusted independently for right or left-hand side of users' body.
- Passive pelvic support.

#### Benefits

- Lumbar adjustment maintains the natural curvature of the spine at the lower back and allows users to choose the support that feels right for them.
- Passive pelvic support rotates the pelvis forward to maintain the natural spine shape.

### 4D Arm

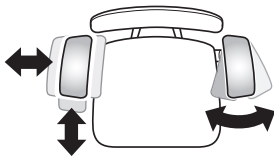

#### Features

- Optional 4D arm.
- Arm adjusts in 4 ways:
  - Height adjustment: 4"(102mm)
  - Side-to-side arm cap adjustment range: 3"(76mm) [1.5"(38mm) each arm cap]
  - Front-to-back adjustment range: 3.5"(89mm)
  - Pivoting: In 20°; out 20°

#### Benefits

- Arms support the muscular system of users' neck and shoulders and proper arm support provides back relief. Arms can be an aid in standing or sitting down.
- Height adjustment accommodates for users with varying elbow rest heights so that users avoid lifting their shoulders or leaning sideways to get arm support.
- Front-to-back adjustment adjusts the armrest length, which is important because it allows users to get close to the work surface while maintaining the effective use of the backrest.
- Side-to-side adjustment ensures a comfortable resting position for the arms with proper support of the forearm while allowing for easy entry/exit of the chair.
- Pivoting provides proper support of the forearm when performing tasks involving keying and mousing.

### Adjustable Height Arm

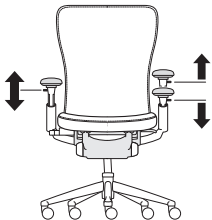

#### Feature

- Optional height adjustable arms adjust 4"(102mm) vertically.

#### Benefit

- Height adjustment accommodates users with varying elbow rest heights so that users avoid lifting their shoulders or leaning sideways to get arm support.

### Tilt with Back Stop

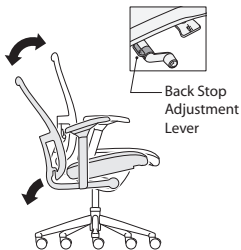

#### Features

- Optional back stop;
  - Back stops in 6 positions - upright and every 4° backward.
  - Tilt limiter.

#### Benefit

- Allows users the choice of selecting an upright position or limiting the amount of recline while performing different tasks.

# Zody

## At-A-Glance — Optional Mobility and Adjustability

### Back Stop/ Forward Tilt

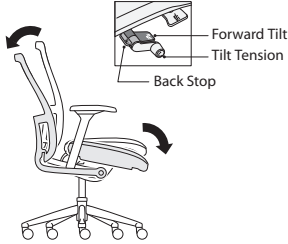

#### Features

- Optional back-stop and forward tilt.
- Back stops in 6 positions, upright and every 4° backward.
- Seat pan moves downward 5° from the initial position.

#### Benefit

- Allows users to vary their posture for maximum comfort and for changes in task requirements.

**Note:** Not available on task stool.

### Base

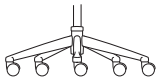

Standard Plastic Base

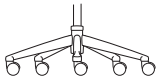

Optional Aluminum Base

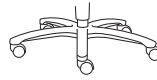

Low Position Base  
(Aluminum only)

#### Colors

TR-F Black

**Note:** When plastic base is specified all metal trim defaults to Black (TR-F)

#### Colors

TR-F Black  
 TR-LE Metallic Silver  
 TR-MC Metallic Champagne  
 PM-P Polished Aluminum

#### Colors

TR-F Black  
 TR-LE Metallic Silver  
 TR-MC Metallic Champagne

**Note:** Low Position Base not available on stool.

### Ergonomic Standards Guidelines

- All Zody models meet or exceed all ANSI/BIFMA durability standards for office seating.
- Zody meets the following ergonomic standards/guidelines:
  - BSR/HFES 100-2002
  - BIFMA G1-2002
  - CSA-Z412-2000
  - CAN/CGSB 44.232-2002
  - HFES 2007

### Specification

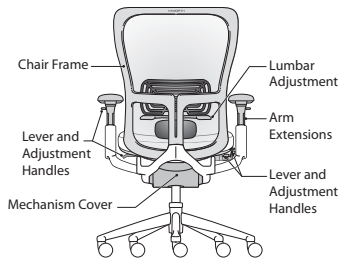

#### Features

- Trim color specification applies to the following components:
  - Chair frame
  - Levers
  - Adjustment handles
  - Lumbar adjustment (not lumbar pad)
  - Arm extensions
  - Mechanism covers
- Arm cap color defaults based on the matrix below.

	Arm Cap Color*	
Trim Color	Black	Smoke
Black (TR-F)	•	
Smoke (TR-E)		•

\*Not specifiable.

# Zody

## Task Chair



SZT-20-002MA1



SZT-20-402MA1



SZT-20-702MA1  
Class ZD

### Features

- Back: Knit, mesh.
- Seat: Standard upholstered with foam.
- Seat Depth: Standard adjustable [3"(76mm) range] or optional fixed.
- Base options:
  - Standard Plastic five-star base in black with hard or soft black casters.
  - Aluminum standard or low-position painted Black, Metallic Silver, Metallic Champagne or Polished Aluminum with hard or soft casters in black.
- Arm options:
  - No arms
  - Height Adjustable with 4"(102mm) adjustment range.
  - 4D with soft arm caps. Height adjustment 4"(102mm), side-to-side arm cap adjustment of 3"(76mm)[1.5"(38mm) each arm cap] Front-to-back adjustment range of 3.5"(89mm) and pivot in 20° and out 20°.
- Arm cap will match frame trim color (Black or Smoke).
- Mechanism: Balanced 3-point tilt; standard tilt tension.
- Height adjustment: Pneumatic or low-position pneumatic.
- Optional Back Stop: Tilt stop in 6 positions.
- Optional Back Stop with Forward Tilt; Seat tilts 5° downward from initial position.
- Asymmetrical Lumbar Adjustment: 4"(102mm) height adjustment; support level can be adjusted independently for right or left hand side of users body.
- Optional PAL Back System: Passive pelvic support.
- COM yardage / COL square footage: 0.75/10

Upcharge for mixed grade surfaces, refer to the electronic design and specification tools.

### Dimensions

Height:	Depth:	Width:
H: 38-43"(965-1092mm)	D: 29"(737mm)	W: 29"(737mm)
*SH: 16-21"(406-533mm)	*SD: 16-19"	*SW: 19.25"(489mm)
*AH: 6.8-10.8" (173-274mm)	(406-483mm)	
Low position seat height: 14-17"(356-432mm)		

*\*Measurements taken with the BIFMA chair measuring device.*

### To Order, Specify:

1) Product number, including:

**1 Seat Material:**

- 1 Leather
- 2 Fabric
- 3 Faux Leather

**2 Base/Caster Option:**

**Plastic Base**

- 5 Plastic Base, Hard Casters
- 6 Plastic Base, Soft Casters (add **\$72.47** list)

**Aluminum Base - Standard**

- 1 Aluminum Base, Hard Casters (add **\$147.53** list)
- 2 Aluminum Base, Soft Casters (add **\$220.00** list)

**Low Base - Aluminum**

- 3 Aluminum Low Base, Hard Casters (add **\$147.53** list)
- 4 Aluminum Low Base, Soft Casters (add **\$220.00** list)

2) Seat upholstery.

3) Back upholstery (Mesh or Knit).

4) Frame color.

- TR-F Black
- TR-E Smoke

5) Base color.

- Plastic Base
- TR-F Black

*Aluminum Base*

- TR-TF Black
- TR-LE Metallic Silver
- TR-MC Metallic Champagne
- PM-P Polished Aluminum (add **\$335.55** list)

# Zody Task Chair

Plastic Base* Adjustments		Number		Fabric								Leather	
Arms		①	②	A	B	C	D	E	F	G	H	A	B
<b>No Lumbar Adjustment - Mesh Back</b>													
Back Stop	No Arm	SZT-	0-001MA	\$ 1747.72	\$ 1808.00	\$ 1872.28	\$ 1904.44	\$ 1928.53	\$ 1986.84	\$ 2039.03	\$ 2181.71	\$ 2280.14	\$ 2541.84
	Height Adjustable	SZT-	0-401MA	2107.36	2167.64	2231.92	2264.08	2288.17	2346.48	2398.67	2541.35	2639.78	2901.48
	4D	SZT-	0-701MA	2173.67	2233.95	2298.23	2330.39	2354.48	2412.79	2464.98	2607.66	2706.09	2967.79
Back Stop/Forward Tilt	No Arm	SZT-	0-004MA	1852.30	1912.58	1976.86	2009.02	2033.11	2091.42	2143.61	2286.29	2384.72	2646.42
	Height Adjustable	SZT-	0-404MA	2211.94	2272.22	2336.50	2368.66	2392.75	2451.06	2503.25	2645.93	2744.36	3006.06
	4D	SZT-	0-704MA	2278.25	2338.53	2402.81	2434.97	2459.06	2517.37	2569.56	2712.24	2810.67	3072.37
<b>No Lumbar Adjustment - Knit Back</b>													
Back Stop	No Arm	SZT-	0-001MA	\$ 1987.13	\$ 2047.41	\$ 2111.69	\$ 2143.85	\$ 2167.94	\$ 2226.25	\$ 2278.44	\$ 2421.12	\$ 2519.55	\$ 2781.25
	Height Adjustable	SZT-	0-411MA	2346.77	2407.05	2471.33	2503.49	2527.58	2585.89	2638.08	2780.76	2879.19	3140.89
	4D	SZT-	0-701MA	2413.08	2473.36	2537.64	2569.80	2593.89	2652.20	2704.39	2847.07	2945.50	3207.20
Back Stop/Forward Tilt	No Arm	SZT-	0-004MA	2091.71	2151.99	2216.27	2248.43	2272.52	2330.83	2383.02	2525.70	2624.13	2885.83
	Height Adjustable	SZT-	0-404MA	2451.35	2511.63	2575.91	2608.07	2632.16	2690.47	2742.66	2885.34	2983.77	3245.47
	4D	SZT-	0-704MA	2517.66	2577.94	2642.22	2674.38	2698.47	2756.78	2808.97	2951.65	3050.08	3311.78
<b>Lumbar Adjustment - Mesh Back</b>													
Back Stop	No Arm	SZT-	0-011MA	\$ 1924.54	\$ 1984.82	\$ 2049.10	\$ 2081.26	\$ 2105.35	\$ 2163.66	\$ 2215.85	\$ 2358.53	\$ 2456.96	\$ 2718.66
	Height Adjustable	SZT-	0-411MA	2284.18	2344.46	2408.74	2440.90	2464.99	2523.30	2575.49	2718.17	2816.60	3078.30
	4D	SZT-	0-711MA	2350.49	2410.77	2475.05	2507.21	2531.30	2589.61	2641.80	2784.48	2882.91	3144.61
Back Stop/Forward Tilt	No Arm	SZT-	0-014MA	2029.12	2089.40	2153.68	2185.84	2209.93	2268.24	2320.43	2463.11	2561.54	2823.24
	Height Adjustable	SZT-	0-414MA	2388.76	2449.04	2513.32	2545.48	2569.57	2627.88	2680.07	2822.75	2921.18	3182.88
	4D	SZT-	0-714MA	2455.07	2515.35	2579.63	2611.79	2635.88	2694.19	2746.38	2889.06	2987.49	3249.19
<b>Lumbar Adjustment - Knit Back</b>													
Back Stop	No Arm	SZT-	0-011MA	\$ 2163.95	\$ 2224.23	\$ 2288.51	\$ 2320.67	\$ 2344.76	\$ 2403.07	\$ 2455.26	\$ 2597.94	\$ 2696.37	\$ 2958.07
	Height Adjustable	SZT-	0-411MA	2523.59	2583.87	2648.15	2680.31	2704.40	2762.71	2814.90	2957.58	3056.01	3317.71
	4D	SZT-	0-711MA	2589.90	2650.18	2714.46	2746.62	2770.71	2829.02	2881.21	3023.89	3122.32	3384.02
Back Stop/Forward Tilt	No Arm	SZT-	0-014MA	2268.53	2328.81	2393.09	2425.25	2449.34	2507.65	2559.84	2702.52	2800.95	3062.65
	Height Adjustable	SZT-	0-414MA	2628.17	2688.45	2752.73	2784.89	2808.98	2867.29	2919.48	3062.16	3160.59	3422.29
	4D	SZT-	0-714MA	2694.48	2754.76	2819.04	2851.20	2875.29	2933.60	2985.79	3128.47	3226.90	3488.60
<b>PAL Back System - Mesh Back</b>													
Back Stop	No Arm	SZT-	0-021MA	\$ 1970.75	\$ 2031.03	\$ 2095.31	\$ 2127.47	\$ 2151.56	\$ 2209.87	\$ 2262.06	\$ 2404.74	\$ 2503.17	\$ 2764.87
	Height Adjustable	SZT-	0-421MA	2330.39	2390.67	2454.95	2487.11	2511.20	2569.51	2621.70	2764.38	2862.81	3124.51
	4D	SZT-	0-721MA	2396.70	2456.98	2521.26	2553.42	2577.51	2635.82	2688.01	2830.69	2929.12	3190.82
Back Stop/Forward Tilt	No Arm	SZT-	0-024MA	2075.33	2135.61	2199.89	2232.05	2256.14	2314.45	2366.64	2509.32	2607.75	2869.45
	Height Adjustable	SZT-	0-424MA	2434.97	2495.25	2559.53	2591.69	2615.78	2674.09	2726.28	2868.96	2967.39	3229.09
	4D	SZT-	0-724MA	2501.28	2561.56	2625.84	2658.00	2682.09	2740.40	2792.59	2935.27	3033.70	3295.40
<b>PAL Back System - Knit Back</b>													
Back Stop	No Arm	SZT-	0-021MA	\$ 2210.16	\$ 2270.44	\$ 2334.72	\$ 2366.88	\$ 2390.97	\$ 2449.28	\$ 2501.47	\$ 2644.15	\$ 2742.58	\$ 3004.28
	Height Adjustable	SZT-	0-421MA	2569.80	2630.08	2694.36	2726.52	2750.61	2808.92	2861.11	3003.79	3102.22	3363.92
	4D	SZT-	0-721MA	2636.11	2696.39	2760.67	2792.83	2816.92	2875.23	2927.42	3070.10	3168.53	3430.23
Back Stop/Forward Tilt	No Arm	SZT-	0-024MA	2314.74	2375.02	2439.30	2471.46	2495.55	2553.86	2606.05	2748.73	2847.16	3108.86
	Height Adjustable	SZT-	0-424MA	2674.38	2734.66	2798.94	2831.10	2855.19	2913.50	2965.69	3108.37	3206.80	3468.50
	4D	SZT-	0-724MA	2740.69	2800.97	2865.25	2897.41	2921.50	2979.81	3032.00	3174.68	3273.11	3534.81

\*Pricing based on plastic base with hard casters.

The following options require modification of the product number.

- Fixed seat
- Stain repellent

To specify, change the 10th digit from A to X; **Example:** SZT-20-002MX1  
 To specify, add P to end of the product number (add \$62.31 list); **Example:** SZT-20-002MA1P

**Note:** For available fabric, refer to [surfaces.haworth.com](https://surfaces.haworth.com).

# Zody

## Task Stool



SZTC-20-002MA1



SZTC-20-402MA1



SZTC-20-702MA1  
Class ZD

### Features

- Back: Knit, mesh.
- Seat: Standard upholstered with foam.
- Seat Depth: Standard adjustable [3"(76mm) range] or optional fixed.
- Base options:
  - Standard Plastic five-star base in black with hard or soft black casters. All metal trim will default to Black TR-F.
  - Aluminum standard painted Black, Metallic Silver, Metallic Champagne or Polished Aluminum with hard or soft casters in black.
- Arm options:
  - No arms
  - Height Adjustable with 4"(102mm) adjustment range.
  - 4D with soft arm caps. Height adjustment 4"(102mm), side-to-side arm cap adjustment of 3"(76mm)[1.5"(38mm) each arm cap] Front-to-back adjustment range of 3.5"(89mm) and pivot in 20° and out 20°.
- Arm cap will match frame trim color (Black or Smoke).
- Mechanism: Balanced 3-point tilt; standard tilt tension.
- Height adjustment: Pneumatic.
- Optional Back Stop: Tilt stop in 6 positions.
- Asymmetrical Lumbar Adjustment: 4"(102mm) height adjustment; support level can be adjusted independently for right or left hand side of users body.
- Optional PAL Back System: Passive pelvic support.
- COM yardage / COL square footage: 0.75/10

Upcharge for mixed grade surfaces, refer to the electronic design and specification tools.

### Dimensions

Height:	Depth:	Width:
H: 43-51"(1092-1295mm)	D: 29"(737mm)	W: 29"(737mm)
*SH: 21.5-29"(546-737mm)	*SD: 16-19"	*SW: 19.25"(489mm)
*AH: 6.8-10.8" (173-274mm)	(406-483mm)	

*\*Measurements taken with the BIFMA chair measuring device.*

### To Order, Specify:

1) Product number, including:

#### 1 Seat Material:

- 1 Leather
- 2 Fabric
- 3 Faux Leather

#### 2 Base/Caster Option:

##### Plastic Base

- 5 Plastic Base, Hard Casters
- 6 Plastic Base, Soft Casters (add **\$72.47** list)

##### Aluminum Base - Standard

- 1 Aluminum Base, Hard Casters (add **\$147.53** list)
- 2 Aluminum Base, Soft Casters (add **\$220.00** list)

2) Seat upholstery.

3) Back upholstery (Mesh or Knit).

4) Frame color.  
TR-F Black  
TR-E Smoke

5) Base color.  
*Plastic Base*  
TR-F Black  
*Aluminum Base*  
TR-TF Black  
TR-LE Metallic Silver  
TR-MC Metallic Champagne  
PM-P Polished Aluminum  
(add **\$335.55** list)

# Zody

## Task Stool

Plastic Base* Adjustments	Arms	Number	Fabric								Leather			
			①	②	A	B	C	D	E	F	G	H	A	B
<b>No Lumbar Adjustment - Mesh Back</b>														
Back Stop	No Arm	SZTC-	0-001MA	\$ 2191.31	\$ 2251.59	\$ 2315.87	\$ 2348.03	\$ 2372.12	\$ 2430.43	\$ 2482.62	\$ 2625.30	\$ 2723.73	\$ 2985.43	
	Height Adjustable	SZTC-	0-401MA	2550.95	2611.23	2675.51	2707.67	2731.76	2790.07	2842.26	2984.94	3083.37	3345.07	
	4D	SZTC-	0-701MA	2617.26	2677.54	2741.82	2773.98	2798.07	2856.38	2908.57	3051.25	3149.68	3411.38	
<b>No Lumbar Adjustment - Knit Back</b>														
Back Stop	No Arm	SZTC-	0-001MA	\$ 2430.72	\$ 2491.00	\$ 2555.28	\$ 2587.44	\$ 2611.53	\$ 2669.84	\$ 2722.03	\$ 2864.71	\$ 2963.14	\$ 3224.84	
	Height Adjustable	SZTC-	0-401MA	2790.36	2850.64	2914.92	2947.08	2971.17	3029.48	3081.67	3224.35	3322.78	3584.48	
	4D	SZTC-	0-701MA	2856.67	2916.95	2981.23	3013.39	3037.48	3095.79	3147.98	3290.66	3389.09	3650.79	
<b>Lumbar Adjustment - Mesh Back</b>														
Back Stop	No Arm	SZTC-	0-011MA	\$ 2368.13	\$ 2428.41	\$ 2492.69	\$ 2524.85	\$ 2548.94	\$ 2607.25	\$ 2659.44	\$ 2802.12	\$ 2900.55	\$ 3162.25	
	Height Adjustable	SZTC-	0-411MA	2727.77	2788.05	2852.33	2884.49	2908.58	2966.89	3019.08	3161.76	3260.19	3521.89	
	4D	SZTC-	0-711MA	2794.08	2854.36	2918.64	2950.80	2974.89	3033.20	3085.39	3228.07	3326.50	3588.20	
<b>Lumbar Adjustment - Knit Back</b>														
Back Stop	No Arm	SZTC-	0-011MA	\$ 2607.54	\$ 2667.82	\$ 2732.10	\$ 2764.26	\$ 2788.35	\$ 2846.66	\$ 2898.85	\$ 3041.53	\$ 3139.96	\$ 3401.66	
	Height Adjustable	SZTC-	0-411MA	2967.18	3027.46	3091.74	3123.90	3147.99	3206.30	3258.49	3401.17	3499.60	3761.30	
	4D	SZTC-	0-711MA	3033.49	3093.77	3158.05	3190.21	3214.30	3272.61	3324.80	3467.48	3565.91	3827.61	
<b>PAL Back System - Mesh Back</b>														
Back Stop	No Arm	SZTC-	0-021MA	\$ 2414.34	\$ 2474.62	\$ 2538.90	\$ 2571.06	\$ 2595.15	\$ 2653.46	\$ 2705.65	\$ 2848.33	\$ 2946.76	\$ 3208.46	
	Height Adjustable	SZTC-	0-421MA	2773.98	2834.26	2898.54	2930.70	2954.79	3013.10	3065.29	3207.97	3306.40	3568.10	
	4D	SZTC-	0-721MA	2840.29	2900.57	2964.85	2997.01	3021.10	3079.41	3131.60	3274.28	3372.71	3634.41	
<b>PAL Back System - Knit Back</b>														
Back Stop	No Arm	SZTC-	0-021MA	\$ 2653.75	\$ 2714.03	\$ 2778.31	\$ 2810.47	\$ 2834.56	\$ 2892.87	\$ 2945.06	\$ 3087.74	\$ 3186.17	\$ 3447.87	
	Height Adjustable	SZTC-	0-421MA	3013.39	3073.67	3137.95	3170.11	3194.20	3252.51	3304.70	3447.38	3545.81	3807.51	
	4D	SZTC-	0-721MA	3079.70	3139.98	3204.26	3236.42	3260.51	3318.82	3371.01	3513.69	3612.12	3873.82	

\*Pricing based on plastic base with hard casters.

The following options require modification of the product number.

- Fixed seat
- Stain repellent

To specify, change the 11th digit from A to X; **Example:** SZTC-20-002MX1  
 To specify, add P to end of the product number (add **\$62.31** list); **Example:** SZTC-20-002MA1P

**Note:** For available fabric, refer to [surfaces.haworth.com](https://surfaces.haworth.com).

# Zody

## Sled Base



SZG-22-1

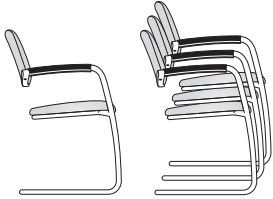

Class ZD

### Features

- Back: Upholstered or Wood (Beech) Fully cantilevered
- Seat: Upholstered
- Base: Sled
- Glide options: Plastic (S) or Felt (J) (Felt glides for use on hard floors. Glides are retrofittable. See service parts.)
- Felt glides are black color.
- Optional Trivalent chrome frame
- Stacking: 4-high
- COM Yardage / COL square footage  
Back: 0.75/15.2  
Seat: 0.75/15.2

### Dimensions

Height:                      Depth:                      Width:  
 H: 32.5"(826mm)          D: 22.1"(561mm)          W: 21"(533mm)  
 \*SH: 18"(457mm)          \*SD: 17"(432mm)          \*SW: 16.8"(427mm)  
 \*AH: 26"(660mm)

*\*Measurements taken with the BIFMA chair measuring device.*

### To Order, Specify:

1) Product number, including:

**1 Sled Base Glides:**

**S** Plastic

**J** Felt

2) Seat surface and color

3) Back surface and color

4) Arm cap trim color

5) Base trim color

Trivalent chrome (KR-V)  
 (add **\$335.55** list)

Seat	Back	Number	Fabric								Leather	
			A	B	C	D	E	F	G	H	A	B
Fabric	Fabric	SZG-22-1	\$1374.31	\$1486.85	\$1615.41	\$1679.69	\$1727.95	\$1840.43	\$1944.91	\$2234.29	N/A	N/A
Fabric	Wood	SZG-2W-1	1543.08	1599.35	1663.63	1695.77	1719.90	1776.14	1828.38	1973.07	N/A	N/A
Leather	Leather	SZG-11-1	N/A	N/A	N/A	N/A	N/A	N/A	N/A	N/A	\$2431.19	\$2951.05
Leather	Wood	SZG-1W-1	N/A	N/A	N/A	N/A	N/A	N/A	N/A	N/A	2071.52	2331.45

The following options require modification of the product number.

- Stain repellent
- Moisture barrier with Stain Repellent
- Faux Leather Seat and Back
- Faux Leather Seat with Wood Back

To specify, add **P** to end of the product number (add **\$62.31** list).

To specify, add **D** to end of the product number (add **\$84.39** list).

To specify, change the 4th digit to **3** and 5th digit to **3**; **Example:** SZG-**33**-S

To specify, change the 4th digit to **3** and 5th digit to **W**; **Example:** SZG-**3W**-J

**Note:** Upcharge for mixed grade surfaces, refer to the electronic design and specification tools. For available fabrics, refer to [surfaces.haworth.com](http://surfaces.haworth.com).

# Zody

## 4 Leg



SZG-22-1



Class ZD

### Features

- Back: Upholstered or Wood (Beech) Fully cantilevered
- Seat: Upholstered
- Base: 4 Legs
- Optional Glide: Plastic (H) or Felt (K) (Felt glides for use on hard floors. Glides are retrofittable. See service parts.)
- Felt glides are black color.
- Optional Trivalent chrome frame
- Stacking: 6-high
- COM Yardage / COL square footage  
Back: 0.75/15.2  
Seat: 0.75/15.2

### Dimensions

Height:                      Depth:                      Width:  
 H: 32.5"(826mm)          D: 22.13"(562mm)      W: 21"(533mm)  
 \*SH: 18"(457mm)        \*SD: 17"(432mm)      \*SW: 16.4"(417mm)  
 \*AH: 26"(660mm)

*\*Measurements taken with the BIFMA chair measuring device.*

### To Order, Specify:

1) Product number, including:

**1 Leg Base Glides:**

**H** Plastic

**K** Felt

2) Seat surface and color

3) Back surface and color

4) Arm cap trim color

5) Base trim color

Trivalent chrome (KR-V)  
 (add **\$335.55** list)

Seat	Back	Number ①	Fabric									Leather	
			A	B	C	D	E	F	G	H	A	B	
Fabric	Fabric	SZG-22-1	\$ 1151.28	\$1263.82	\$1392.38	\$1456.66	\$1504.92	\$ 1617.40	\$ 1721.88	\$ 2011.26	N/A	N/A	
Fabric	Wood	SZG-2W-1	1320.05	1376.32	1440.60	1472.74	1496.87	1553.11	1605.35	1750.04	N/A	N/A	
Leather	Leather	SZG-11-1	N/A	N/A	N/A	N/A	N/A	N/A	N/A	N/A	\$2208.16	\$2728.02	
Leather	Wood	SZG-1W-1	N/A	N/A	N/A	N/A	N/A	N/A	N/A	N/A	1848.49	2108.42	

The following options require modification of the product number.

Stain repellent

Moisture barrier with Stain Repellent

Faux Leather Seat and Back

Faux Leather Seat with Wood Back

To specify, add **P** to end of the product number (add **\$62.31** list).

To specify, add **D** to end of the product number (add **\$84.39** list).

To specify, change the 4th digit to **3** and 5th digit to **3**; **Example:** SZG-**33**-S

To specify, change the 4th digit to **3** and 5th digit to **W**; **Example:** SZG-**3W**-J

**Note:** Upcharge for mixed grade surfaces, refer to the electronic design and specification tools. For available fabrics, refer to [surfaces.haworth.com](http://surfaces.haworth.com).

# Very Task

## At-A-Glance

The Very Task chair offers state-of-the-art ergonomic support. Very Task offers Haworth's patented asymmetrical lumbar along with supporting mesh or knit back. A clean simple aesthetic, with unlimited choices, allowing you to personalize how you want to sit and work.

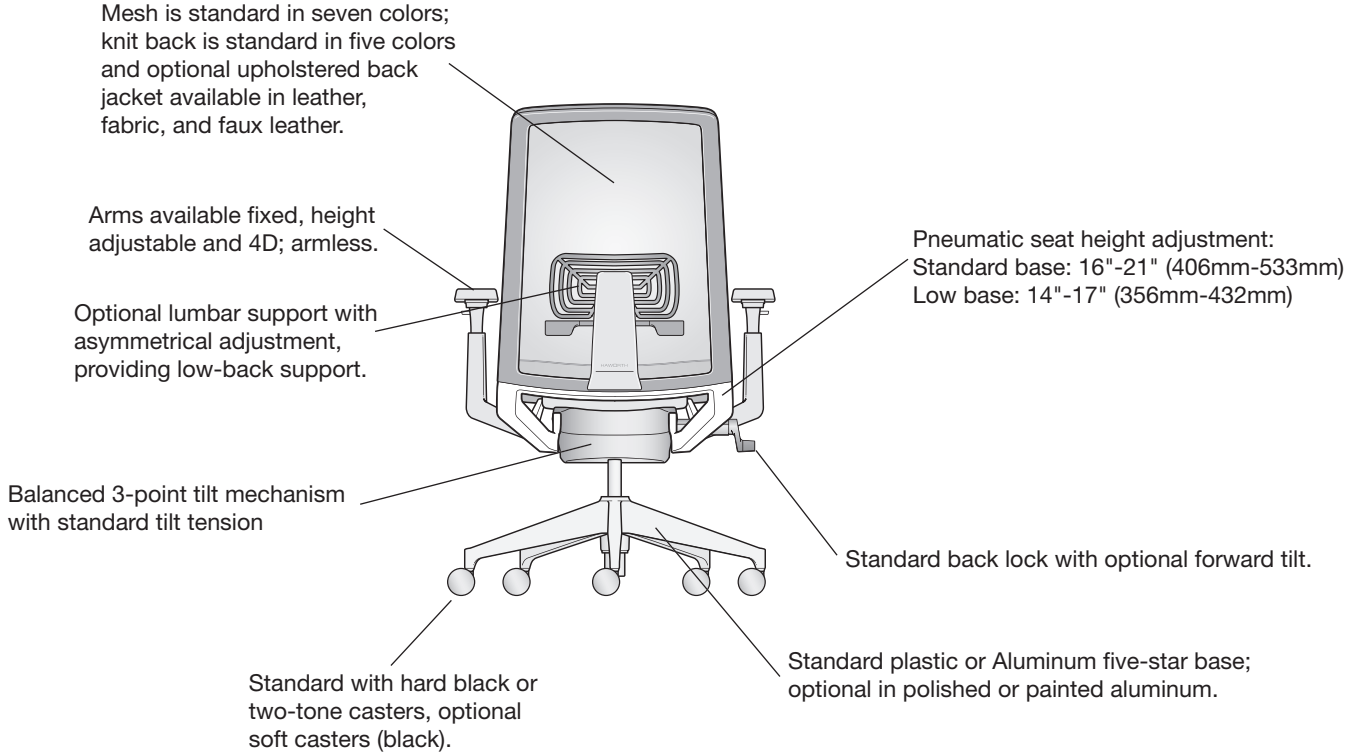

# Very Task

## At-A-Glance

### Catalog Logic

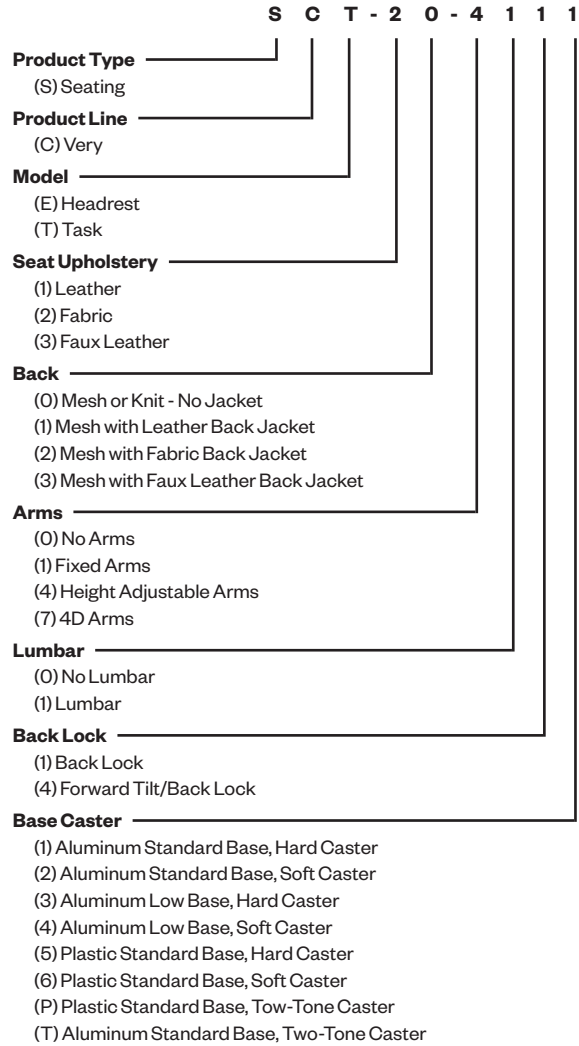

# Very Task

## At-A-Glance

---

### Features and Options (Task Chair)

- Back: Mesh or knit with optional upholstered back jacket.
- Seat: Standard upholstered with foam.
- Seat Type: Standard depth adjustable range 16"-19" (406mm-483mm).
- Base: Standard plastic or optional painted five-star aluminum base or optional polished aluminum.
- Optional low base 14"-17"(356mm-432mm) (not available in high polished)
- Arms: 4D, Height Adjustable arms, fixed arms with soft arm caps. Armless model available.
- Mechanism: Balanced 3-point tilt; standard tilt tension.
- Height adjustment: Pneumatic or low-position pneumatic.
- Standard Back lock.
- Optional Forward Tilt: 5 degrees downward from initial position.
- Optional Adjustable Lumbar: per"(mm) adjustment, flexible support.
- Optional Headrest: Height adjustable with articulating movement.
- Casters: Five-star base with casters: hard (black or two-tone (fog and gray), soft (black).
- Headrest sent not attached.

---

### Environmental Factors

- Refer to Product Environmental Data sheet (PED) for recycled content and certifications.
- Very is produced in an ISO 14001 certified manufacturing facility.
- Very Task is part of the Haworth Take Back Program.
- Haworth will take back Very chairs after their useful life and recycle the components. Please contact Haworth's Material Recovery Center at (616)393-1215.

---

### COM & COL General Information

To order a COM fabric (Customer's Own Material), contact the Haworth Inquiry Center (1.800.426.8562), your local Haworth dealer, or go to [haworth.com/surfaces](http://haworth.com/surfaces) to find out if the COM you have selected has already been tested and approved. The surface collection site also has information on the Haworth alliance program with Carnegie, Luna Textiles, and Maharam as well as our industry-leading Pre-Approved COM program.

COM fabrics are placed into Grades based on the cost per linear yard. If a fabric's cost exceeds the range of our highest Grade it will be noted as Non-Graded. The product will be priced at Grade A; the COM fabric costs will appear as a separate line item. The fabric charge will be Haworth's purchase cost plus a 4% administrative fee (based on the cost of the fabric). Yardage calculations will include any applicable fabric repeat.

COM Leather products will be priced at a leather Grade A; COL costs will appear as a separate line item. The leather costs will be Haworth's purchase cost plus a 4% administrative fee (based on the cost of the leather).

---

### Finishes and Fabrics

A complete listing of finishes and fabrics for Very seating is available in the back of the price list.

---

### Stain Repellent

Stain Repellent or Stain Repellent with Moisture Barrier available on fabric surfaces only.

Stain Repellent only: To specify add "P" to the end of the product number. Example: SCT-20-0011P

Stain Repellent with Moisture Barrier: To specify add "D" to the end of the product number. Example: SCT-20-0011D

---

### Shipping Weights (Including packaging)

- Chairs with arms: 55.2 pounds/1 chair per carton/17.37 cubic feet
- Chairs without arms: 51.2 pounds/1 chair per carton/17.37 cubic feet

---

### Seat

Stitched double seams. Vertically in the center and on the edges of the leather seat cushion.

---

### Back

Vertical stitched double seams on the upholstered back jacket with leather and faux leather or Customers Own Leather or COM faux leather.

---

### Specifications

Task chairs and stools designed for use by individuals up to 350 lbs.\*

\* Task chairs with forward tilt are designed for use by individuals up to 325lbs.

# Very Task

## At-A-Glance — Standard Mobility and Adjustability

### Balanced 3-point Tilt



#### Features

- Balanced 3-point tilt mechanism.
- Back reclines 20° from the upright position.
- Seat pan moves downward 3° from the initial position.
- 2:1 recline ratio.

#### Benefits

- Comfortable relaxed posture.
- Recline allows for the opening of the users' chest cavity providing good airflow to promote alertness.
- Users' feet remain flat on the floor.

### Tilt Tension Control

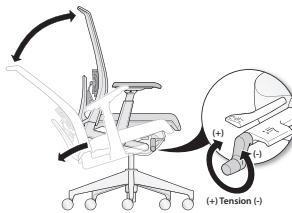

#### Feature

- Easy-to-reach and easy-to-activate side-mounted unlimited tilt tension control regulates the amount of resistance felt when leaning back in the chair and the effort required to recline the chair backwards.

#### Benefit

- Personalized support to accommodate users of different body types and different work styles.

### Seat Height Adjustment

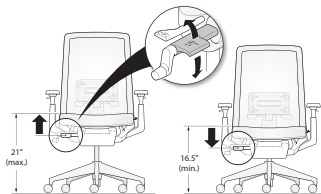

#### Features

- Pneumatic seat height adjustment.
- Seat height adjusts 5"(127mm) from 16" to 21"(406mm to 533mm) in standard models. Low-position adjusts 14" to 17"(356 to 432mm).

#### Benefits

- Ensures the comfort of the lower limbs by avoiding pressure on the underside of the thigh caused by a seat pan that is too high, or decreased thigh-to-torso angle if the seat pan is too low.
- Seat height adjustment also is important in setting the proper hand position and allowing for a proper sitting eye height.

### Seat Depth Adjustment

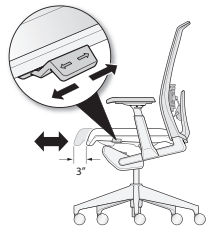

#### Feature

- 3"(76mm) of seat depth range.

#### Benefit

- Supports the thighs, allows users to rest against the seat back for back support, and avoids pressure on the back of the knees of small to tall users.

# Very Task

## At-A-Glance — Optional Mobility and Adjustability

### Back Lock



#### Feature

- Single position Back Lock.

#### Benefit

- Allows users to lock the back of the chair in the upright position for tasking application.

### Forward Tilt



#### Features

- Optional forward tilt.
- 5°

#### Benefit

- Allows users the ability to elect an upright forward position.

### 4D Arm

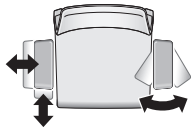

#### Features

- Optional 4D arm.
- Arm adjusts in 4 ways:
  - Height adjustment: 4”(102mm)
  - Side-to-side arm cap adjustment range: 3”(76mm) [1.5”(38mm) each arm cap]
  - Front-to-back adjustment range: 3.5”(89mm)
  - Pivoting: In 20°; out 20°

#### Benefits

- Arms support the muscular system of users' neck and shoulders and proper arm support provides back relief. Arms can be an aid in standing or sitting down.
- Height adjustment accommodates for users with varying elbow rest heights so that users avoid lifting their shoulders or leaning sideways to get arm support.
- Front-to-back adjustment adjusts the armrest length, which is important because it allows users to get close to the worksurface while maintaining the effective use of the backrest.
- Side-to-side adjustment ensures a comfortable resting position for the arms with proper support of the forearm while allowing for easy entry/exit of the chair.
- Pivoting provides proper support of the forearm when performing tasks involving keying and mousing.

### Adjustable Height Arm

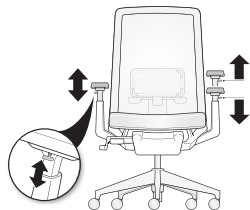

#### Feature

- Optional height adjustable arms adjust 4”(102mm) vertically.

#### Benefit

- Height adjustment accommodates users with varying elbow rest heights so that users avoid lifting their shoulders or leaning sideways to get arm support.

# Very Task

## At-A-Glance — Optional Mobility and Adjustability

### Lumbar Support

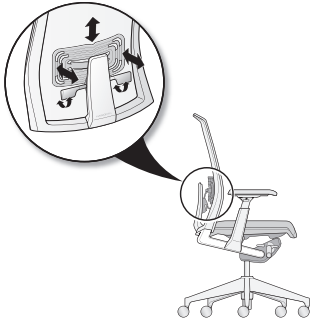

#### Feature

- Asymmetrical Left/right Lumbar Adjustment adjusts 4"(102mm) in height, flexible lumbar support with depth adjustment.

#### Benefit

- Lumbar adjustment maintains the natural curvature of the spine at the lower back and allows users to choose the support that feels right for them.

### Headrest



#### Features

- Height adjustable 4.2"(107mm), articulating movement of headrest pad and mount to fit a wide range of users.
- Headrest is TPU material. Available in two finishes: black or fog; coordinates with the chair armrest color specified.
- See price pages for specification (available on all models).
- To add a headrest to an existing model in the field order service part: Back and Headrest placement, see e-Parts.
- Headrest sent not attached.

# Very Task Chair



SCT-20-0011



SCT-20-1011



SCT-20-4011



SCT-20-7011  
Class VT

## Features

- Back: Knit, mesh, or mesh back with upholstered back jacket.
- Seat: Standard upholstered foam.
- Base options:
  - Plastic standard five-star base in Black or Fog. Hard casters in black or two-tone grey or soft casters in black.
  - Aluminum standard five-star base painted or polished aluminum. Painted in Black, Metallic Champagne or Metallic Silver. Hard casters in black or two-tone grey or soft casters in black.
  - Aluminum low-position painted in Black, Metallic Champagne or Metallic Silver. Hard or soft casters in black.
- Arm options:
  - No arms
  - Fixed
  - Height Adjustable with 4"(102mm) adjustment range.
  - 4D with soft arm caps. Height adjustment 4"(102mm), side-to-side arm cap adjustment of 3"(76mm)[1.5"(38mm) each arm cap] Front-to-back adjustment range of 3.5"(89mm) and pivot in 20° and out 20°.
- Height adjustment: Pneumatic or low-position pneumatic.
- Mechanism: Balanced 3-point tilt; standard tilt tension.
- Back Lock: Single position upright back lock.
- Forward Tilt (Optional): 5° downward from initial position.
- Asymmetrical Lumbar Adjustment: 4"(102mm) height adjustment; support level can be adjusted independently for right or left hand side of users body.
- Back Jacket: Mesh color required for outside of back. Not field retrofittable. To add back jacket in the field see e-Parts for replacement back with attached back jacket.
- COM yardage / COL square footage: 0.75/10  
Mesh/Knit back model: 0.83/20  
Mesh/upholstered back jacket: 1.5/40

Upcharge for mixed grade surfaces, refer to the electronic design and specification tools.

## Dimensions

Height	Depth	Width:
H: 39-44" (991-1118mm)	D: 26"(660mm) *SD: 16-19" (406-483mm)	W: 27"(686mm) *SW: 19"(483mm)
*SH: 16-21" (406-533mm)		
*AH: 6.5-10.5" (165-267mm)		
Low position seat height: 14-17"(356-432mm)		

\*Measurements taken with the BIFMA chair measuring device.

## To Order, Specify:

1) Product number, including:

### 1 Seat Upholstery:

- 1 Leather
- 2 Fabric
- 3 Faux Leather

### 2 Back Upholstery:

- 0 Mesh or Knit
- 1 Leather Back Jacket
- 2 Fabric Back Jacket
- 3 Faux Leather Back Jacket

### 3 Base/Caster Option:

#### Plastic Base

- 5 Plastic Base, Hard Casters
- 6 Plastic Base, Soft Casters (add **\$63.14** list)
- P Plastic Base, Two-Tone Casters (add **\$26.75** list)

#### Aluminum Base - Standard

- 1 Aluminum Base, Hard Casters (add **\$96.71** list)
- 2 Aluminum Base, Soft Casters (add **\$159.85** list)
- T Aluminum Base, Two-Tone Casters (add **\$123.46** list)

#### Low Base - Aluminum

- 3 Aluminum Low Base, Hard Casters (add **\$96.71** list)
- 4 Aluminum Low Base, Soft Casters (add **\$159.85** list)

- 2) Seat upholstery.
- 3) Back upholstery (Mesh or Knit).
- 4) Back Jacket upholstery (if applicable).
- 5) Plastic trim color.<sup>1</sup>
  - TR-F Black
  - TR-7 Fog
  - TR-UFM Snow<sup>2</sup> (add **\$146.31** list)
- 6) Aluminum (underside of chair) color.
  - TR-F Black
  - TR-LE Metallic Silver
  - TR-MC Metallic Champagne
  - TR-FS Snowfall
  - PM-P Polished Aluminum (add **\$299.74** list)
- 7) Base color.
  - Plastic Base
    - TR-F Black
    - TR-7 Fog
  - Aluminum Base
    - TR-F Black
    - TR-LE Metallic Silver
    - TR-MC Metallic Champagne
    - PM-P Polished Aluminum (add **\$299.74** list)

<sup>1</sup> Arm caps, control cover, adjustment levers, and 4D and Height Adjustable arm uprights.

<sup>2</sup> When TR-UFM Snow trim is specified, arm cap and head rest will default to TR-7 Fog.

# Very Task Chair

Plastic Base* Adjustments	Arms	Number ① ② ③	Fabric								Leather	
			A	B	C	D	E	F	G	H	A	B
<b>No Lumbar Adjustment - Mesh Back</b>												
Back Stop	No arm	SCT- 0-001	\$ 1135.10	\$ 1189.23	\$ 1247.27	\$ 1274.34	\$ 1297.55	\$ 1347.83	\$ 1394.22	\$ 1517.99	\$ 1628.21	\$ 1869.56
	Fixed	SCT- 0-101	1357.47	1411.60	1469.64	1496.71	1519.92	1570.20	1616.59	1740.36	1850.58	2091.93
	Height Adjustable	SCT- 0-401	1376.81	1430.94	1488.98	1516.05	1539.26	1589.54	1635.93	1759.70	1869.92	2111.27
	4D	SCT- 0-701	1473.51	1527.64	1585.68	1612.75	1635.96	1686.24	1732.63	1856.40	1966.62	2207.97
Back Stop/Forward Tilt	No arm	SCT- 0-004	1241.47	1295.60	1353.64	1380.71	1403.92	1454.20	1500.59	1624.36	1734.58	1975.93
	Fixed	SCT- 0-104	1463.84	1517.97	1576.01	1603.08	1626.29	1676.57	1722.96	1846.73	1956.95	2198.30
	Height Adjustable	SCT- 0-404	1483.18	1537.31	1595.35	1622.42	1645.63	1695.91	1742.30	1866.07	1976.29	2217.64
	4D	SCT- 0-704	1579.88	1634.01	1692.05	1719.12	1742.33	1792.61	1839.00	1962.77	2072.99	2314.34
<b>No Lumbar Adjustment - Knit Back</b>												
Back Stop	No arm	SCT- 0-001	\$ 1310.49	\$ 1364.62	\$ 1422.66	\$ 1449.73	\$ 1472.94	\$ 1523.22	\$ 1569.61	\$ 1693.38	\$ 1803.60	\$ 2044.95
	Fixed	SCT- 0-101	1532.86	1586.99	1645.03	1672.10	1695.31	1745.59	1791.98	1915.75	2025.97	2267.32
	Height Adjustable	SCT- 0-401	1552.20	1606.33	1664.37	1691.44	1714.65	1764.93	1811.32	1935.09	2045.31	2286.66
	4D	SCT- 0-701	1648.90	1703.03	1761.07	1788.14	1811.35	1861.63	1908.02	2031.79	2142.01	2383.36
Back Stop/Forward Tilt	No arm	SCT- 0-004	1416.86	1470.99	1529.03	1556.10	1579.31	1629.59	1675.98	1799.75	1909.97	2151.32
	Fixed	SCT- 0-104	1639.23	1693.36	1751.40	1778.47	1801.68	1851.96	1898.35	2022.12	2132.34	2373.69
	Height Adjustable	SCT- 0-404	1658.57	1712.70	1770.74	1797.81	1821.02	1871.30	1917.69	2041.46	2151.68	2393.03
	4D	SCT- 0-704	1755.27	1809.40	1867.44	1894.51	1917.72	1968.00	2014.39	2138.16	2248.38	2489.73
<b>No Lumbar Adjustment - Upholstered Back Jacket</b>												
Back Stop	No arm	SCT- -001	\$ 1338.14	\$ 1446.40	\$ 1562.48	\$ 1616.62	\$ 1663.04	\$ 1763.60	\$ 1856.38	\$ 2103.92	\$ 2324.36	\$ 2807.06
	Fixed	SCT- -101	1560.51	1668.77	1784.85	1838.99	1885.41	1985.97	2078.75	2326.29	2546.73	3029.43
	Height Adjustable	SCT- -401	1579.85	1688.11	1804.19	1858.33	1904.75	2005.31	2098.09	2345.63	2566.07	3048.77
	4D	SCT- -701	1676.55	1784.81	1900.89	1955.03	2001.45	2102.01	2194.79	2442.33	2662.77	3145.47
Back Stop/Forward Tilt	No arm	SCT- -004	1444.51	1552.77	1668.85	1722.99	1769.41	1869.97	1962.75	2210.29	2430.73	2913.43
	Fixed	SCT- -104	1666.88	1775.14	1891.22	1945.36	1991.78	2092.34	2185.12	2432.66	2653.10	3135.80
	Height Adjustable	SCT- -404	1686.22	1794.48	1910.56	1964.70	2011.12	2111.68	2204.46	2452.00	2672.44	3155.14
	4D	SCT- -704	1782.92	1891.18	2007.26	2061.40	2107.82	2208.38	2301.16	2548.70	2769.14	3251.84
<b>Lumbar Adjustment - Mesh Back</b>												
Back Stop	No arm	SCT- 0-011	\$ 1270.47	\$ 1324.60	\$ 1382.64	\$ 1409.71	\$ 1432.92	\$ 1483.20	\$ 1529.59	\$ 1653.36	\$ 1763.58	\$ 2004.93
	Fixed	SCT- 0-111	1492.84	1546.97	1605.01	1632.08	1655.29	1705.57	1751.96	1875.73	1985.95	2227.30
	Height Adjustable	SCT- 0-411	1512.18	1566.31	1624.35	1651.42	1674.63	1724.91	1771.30	1895.07	2005.29	2246.64
	4D	SCT- 0-711	1608.88	1663.01	1721.05	1748.12	1771.33	1821.61	1868.00	1991.77	2101.99	2343.34
Back Stop/Forward Tilt	No arm	SCT- 0-014	1376.84	1430.97	1489.01	1516.08	1539.29	1589.57	1635.96	1759.73	1869.95	2111.30
	Fixed	SCT- 0-114	1599.21	1653.34	1711.38	1738.45	1761.66	1811.94	1858.33	1982.10	2092.32	2333.67
	Height Adjustable	SCT- 0-414	1618.55	1672.68	1730.72	1757.79	1781.00	1831.28	1877.67	2001.44	2111.66	2353.01
	4D	SCT- 0-714	1715.25	1769.38	1827.42	1854.49	1877.70	1927.98	1974.37	2098.14	2208.36	2449.71
<b>Lumbar Adjustment - Knit Back</b>												
Back Stop	No arm	SCT- 0-011	\$ 1445.86	\$ 1499.99	\$ 1558.03	\$ 1585.10	\$ 1608.31	\$ 1658.59	\$ 1704.98	\$ 1828.75	\$ 1938.97	\$ 2180.32
	Fixed	SCT- 0-111	1668.23	1722.36	1780.40	1807.47	1830.68	1880.96	1927.35	2051.12	2161.34	2402.69
	Height Adjustable	SCT- 0-411	1687.57	1741.70	1799.74	1826.81	1850.02	1900.30	1946.69	2070.46	2180.68	2422.03
	4D	SCT- 0-711	1784.27	1838.40	1896.44	1923.51	1946.72	1997.00	2043.39	2167.16	2277.38	2518.73
Back Stop/Forward Tilt	No arm	SCT- 0-014	1552.23	1606.36	1664.40	1691.47	1714.68	1764.96	1811.35	1935.12	2045.34	2286.69
	Fixed	SCT- 0-114	1774.60	1828.73	1886.77	1913.84	1937.05	1987.33	2033.72	2157.49	2267.71	2509.06
	Height Adjustable	SCT- 0-414	1793.94	1848.07	1906.11	1933.18	1956.39	2006.67	2053.06	2176.83	2287.05	2528.40
	4D	SCT- 0-714	1890.64	1944.77	2002.81	2029.88	2053.09	2103.37	2149.76	2273.53	2383.75	2625.10
<b>Lumbar Adjustment - Upholstered Back Jacket</b>												
Back Stop	No arm	SCT- -011	\$ 1473.51	\$ 1581.77	\$ 1697.85	\$ 1751.99	\$ 1798.41	\$ 1898.97	\$ 1991.75	\$ 2239.29	\$ 2459.73	\$ 2942.43
	Fixed	SCT- -111	1695.88	1804.14	1920.22	1974.36	2020.78	2121.34	2214.12	2461.66	2682.10	3164.80
	Height Adjustable	SCT- -411	1715.22	1823.48	1939.56	1993.70	2040.12	2140.68	2233.46	2481.00	2701.44	3184.14
	4D	SCT- -711	1811.92	1920.18	2036.26	2090.40	2136.82	2237.38	2330.16	2577.70	2798.14	3280.84
Back Stop/Forward Tilt	No arm	SCT- -014	1579.88	1688.14	1804.22	1858.36	1904.78	2005.34	2098.12	2345.66	2566.10	3048.80
	Fixed	SCT- -114	1802.25	1910.51	2026.59	2080.73	2127.15	2227.71	2320.49	2568.03	2788.47	3271.17
	Height Adjustable	SCT- -414	1821.59	1929.85	2045.93	2100.07	2146.49	2247.05	2339.83	2587.37	2807.81	3290.51
	4D	SCT- -714	1918.29	2026.55	2142.63	2196.77	2243.19	2343.75	2436.53	2684.07	2904.51	3387.21

\*Pricing based on plastic base with hard casters.

The following options require modification of the product number.

- Headrest To specify, change the 3rd digit from a **T** to and **E** (add **\$135.37** list); **Example:** SCE-22-712
- Stain repellent To specify, add **P** to the end of the product number (add **\$59.95** list); **Example:** SCT-20-1011P

# Very Task Stool



SCTC-20-0011



SCTC-20-1011



SCTC-20-4011



SCTC-20-7011  
Class VT

### Features

- Back: Knit, mesh, or mesh back with upholstered back jacket.
- Seat: Standard upholstered foam.
- Base options:
  - Standard Plastic five-star base in Black or Fog. Hard casters in black or two-tone or soft casters in black.
  - Aluminum standard five-star base painted or polished aluminum. Painted in Black, Metallic Champagne or Metallic Silver. Hard casters in black or two-tone or soft casters in black.
- Arm options:
  - No arms
  - Fixed
  - Height Adjustable with 4"(102mm) adjustment range.
  - 4D with soft arm caps. Height adjustment 4"(102mm), side-to-side arm cap adjustment of 3"(76mm)[1.5"(38mm) each arm cap] Front-to-back adjustment range of 3.5"(89mm) and pivot in 20° and out 20°.
- Height adjustment: Pneumatic.
- Mechanism: Balanced 3-point tilt; standard tilt tension.
- Back Lock: Single position upright back lock.
- Adjustable height footring.
- Asymmetrical Lumbar Adjustment: 4"(102mm) height adjustment; support level can be adjusted independently for right or left hand side of users body.
- Back Jacket: Mesh color required for outside of back. Not field retrofittable. To add back jacket in the field see e-Parts for replacement back with attached back jacket.
- COM yardage / COL square footage: 0.75/10  
Mesh/Knit back model: 0.83/20  
Mesh/upholstered back jacket: 1.5/40

Upcharge for mixed grade surfaces, refer to the electronic design and specification tools.

### Dimensions

Height	Depth	Width:
H: 43-51" (1092-1295mm)	D: 26"(660mm) *SD: 16-19" (406-483mm)	W: 27"(686mm) *SW: 19"(483mm)
*SH: 20-28" (508-711mm)		
*AH: 6.5-10.5" (165-267mm)		

\*Measurements taken with the BIFMA chair measuring device.

### To Order, Specify:

1) Product number, including:

#### 1 Seat Upholstery:

- 1 Leather
- 2 Fabric
- 3 Faux Leather

#### 2 Back Upholstery:

- 0 Mesh or Knit
- 1 Leather Back Jacket
- 2 Fabric Back Jacket
- 3 Faux Leather Back Jacket

#### 3 Base/Caster Option:

##### Plastic Base

- 5 Plastic Base, Hard Casters
- 6 Plastic Base, Soft Casters (add **\$63.14** list)
- P Plastic Base, Two-Tone Casters (add **\$26.75** list)

##### Aluminum Base - Standard

- 1 Aluminum Base, Hard Casters (add **\$96.71** list)
- 2 Aluminum Base, Soft Casters (add **\$159.85** list)
- T Aluminum Base, Two-Tone Casters (add **\$123.46** list)

- 2) Seat upholstery.
- 3) Back upholstery (Mesh or Knit).
- 4) Back Jacket upholstery (if applicable).
- 5) Plastic trim color.<sup>1</sup>
  - TR-F Black
  - TR-7 Fog
  - TR-UFM Snow<sup>2</sup> (add **\$146.31** list)
- 6) Aluminum (underside of chair) color.
  - TR-F Black
  - TR-LE Metallic Silver
  - TR-MC Metallic Champagne
  - TR-FS Snowfall
  - PM-P Polished Aluminum (add **\$299.74** list)
- 7) Base color.
  - Plastic Base*
    - TR-F Black
    - TR-7 Fog
  - Aluminum Base*
    - TR-F Black
    - TR-LE Metallic Silver
    - TR-MC Metallic Champagne
    - PM-P Polished Aluminum (add **\$299.74** list)

<sup>1</sup> Arm caps, control cover, adjustment levers, and 4D and Height Adjustable arm uprights.

<sup>2</sup> When TR-UFM Snow trim is specified, arm cap and head rest will default to TR-7 Fog.

# Very Task Stool

Plastic Base* Adjustments	Arms	Number ① ② ③	Fabric								Leather	
			A	B	C	D	E	F	G	H	A	B
<b>No Lumbar Adjustment - Mesh Back</b>												
Back Stop	No arm	SCTC- 0-001	\$ 1804.07	\$ 1858.20	\$ 1916.24	\$ 1943.31	\$ 1966.52	\$ 2016.80	\$ 2063.19	\$ 2186.96	\$ 2297.18	\$ 2538.53
	Fixed	SCTC- 0-101	2026.44	2080.57	2138.61	2165.68	2188.89	2239.17	2285.56	2409.33	2519.55	2760.90
	Height Adjustable	SCTC- 0-401	2045.78	2099.91	2157.95	2185.02	2208.23	2258.51	2304.90	2428.67	2538.89	2780.24
	4D	SCTC- 0-701	2142.48	2196.61	2254.65	2281.72	2304.93	2355.21	2401.60	2525.37	2635.59	2876.94
<b>No Lumbar Adjustment - Knit Back</b>												
Back Stop	No arm	SCTC- 0-001	\$ 1979.46	\$ 2033.59	\$ 2091.63	\$ 2118.70	\$ 2141.91	\$ 2192.19	\$ 2238.58	\$ 2362.35	\$ 2472.57	\$ 2713.92
	Fixed	SCTC- 0-101	2201.83	2255.96	2314.00	2341.07	2364.28	2414.56	2460.95	2584.72	2694.94	2936.29
	Height Adjustable	SCTC- 0-401	2221.17	2275.30	2333.34	2360.41	2383.62	2433.90	2480.29	2604.06	2714.28	2955.63
	4D	SCTC- 0-701	2317.87	2372.00	2430.04	2457.11	2480.32	2530.60	2576.99	2700.76	2810.98	3052.33
<b>No Lumbar Adjustment - Upholstered Back Jacket</b>												
Back Stop	No arm	SCTC- -001	\$ 2007.11	\$ 2115.37	\$ 2231.45	\$ 2285.59	\$ 2332.01	\$ 2432.57	\$ 2525.35	\$ 2772.89	\$ 2993.33	\$ 3476.03
	Fixed	SCTC- -101	2229.48	2337.74	2453.82	2507.96	2554.38	2654.94	2747.72	2995.26	3215.70	3698.40
	Height Adjustable	SCTC- -401	2248.82	2357.08	2473.16	2527.30	2573.72	2674.28	2767.06	3014.60	3235.04	3717.74
	4D	SCTC- -701	2345.52	2453.78	2569.86	2624.00	2670.42	2770.98	2863.76	3111.30	3331.74	3814.44
<b>Lumbar Adjustment - Mesh Back</b>												
Back Stop	No arm	SCTC- 0-011	\$ 1939.44	\$ 1993.57	\$ 2051.61	\$ 2078.68	\$ 2101.89	\$ 2152.17	\$ 2198.56	\$ 2322.33	\$ 2432.55	\$ 2673.90
	Fixed	SCTC- 0-111	2161.81	2215.94	2273.98	2301.05	2324.26	2374.54	2420.93	2544.70	2654.92	2896.27
	Height Adjustable	SCTC- 0-411	2181.15	2235.28	2293.32	2320.39	2343.60	2393.88	2440.27	2564.04	2674.26	2915.61
	4D	SCTC- 0-711	2277.85	2331.98	2390.02	2417.09	2440.30	2490.58	2536.97	2660.74	2770.96	3012.31
<b>Lumbar Adjustment - Knit Back</b>												
Back Stop	No arm	SCTC- 0-011	\$ 2114.83	\$ 2168.96	\$ 2227.00	\$ 2254.07	\$ 2277.28	\$ 2327.56	\$ 2373.95	\$ 2497.72	\$ 2607.94	\$ 2849.29
	Fixed	SCTC- 0-111	2337.20	2391.33	2449.37	2476.44	2499.65	2549.93	2596.32	2720.09	2830.31	3071.66
	Height Adjustable	SCTC- 0-411	2356.54	2410.67	2468.71	2495.78	2518.99	2569.27	2615.66	2739.43	2849.65	3091.00
	4D	SCTC- 0-711	2453.24	2507.37	2565.41	2592.48	2615.69	2665.97	2712.36	2836.13	2946.35	3187.70
<b>Lumbar Adjustment - Upholstered Back Jacket</b>												
Back Stop	No arm	SCTC- -011	\$ 2142.48	\$ 2250.74	\$ 2366.82	\$ 2420.96	\$ 2467.38	\$ 2567.94	\$ 2660.72	\$ 2908.26	\$ 3128.70	\$ 3611.40
	Fixed	SCTC- -111	2364.85	2473.11	2589.19	2643.33	2689.75	2790.31	2883.09	3130.63	3351.07	3833.77
	Height Adjustable	SCTC- -411	2384.19	2492.45	2608.53	2662.67	2709.09	2809.65	2902.43	3149.97	3370.41	3853.11
	4D	SCTC- -711	2480.89	2589.15	2705.23	2759.37	2805.79	2906.35	2999.13	3246.67	3467.11	3949.81

\*Pricing based on plastic base with hard casters.

The following options require modification of the product number.

Stain repellent

To specify, add **P** to the end of the product number (add **\$59.95** list); **Example: SCTC-20-1011P**

# Very Wire Stacker

## At-A-Glance

### Features and Options (Wire Stacker and Wire Stool)

#### Wire Stacker Chair

- 11mm solid steel rod frame
- Single piece high-strength polymer shell seat and back
- Clear nylon glides
- Frame finishes include: painted or Trivalent chrome
- Optional upholstered foam pad on seat or seat and back
- Fog or black trim arm caps
- Arm or armless version available
- Arm chair stacks 5-high on the floor or 15-high on a cart. Dimensions for 15-high on cart: 54"(1372mm)H x 55"(1397mm)D x 24"(610mm)W.
- Armless stacks 10-high on the floor, upholstered or non-upholstered; stacks 30-high non-upholstered on a cart (63.5"(1613mm)H x 37"(940mm)D x 24"(610mm)W); stacks 25-high upholstered on a cart (61"(1549mm)H x 40.5"(1029mm)D x 24"(610mm)W).
- Seat: Stitched double seams. Vertically in the center and on the edges of the leather seat cushion.
- Ganging option: arm chair to armless, armless to armless.
- Chairs with arms: 16 lbs.
- Chairs without arms: 15 lbs.

#### Wire Stacker Stool

- Chrome frame
- Stacks 5-high on the floor.
- Single piece high-strength polymer shell seat and back
- Clear nylon glides
- Fog or black trim arm caps
- Arm or armless version available

### Specifications

Designed for use by individuals up to 325 lbs.

### Catalog Logic

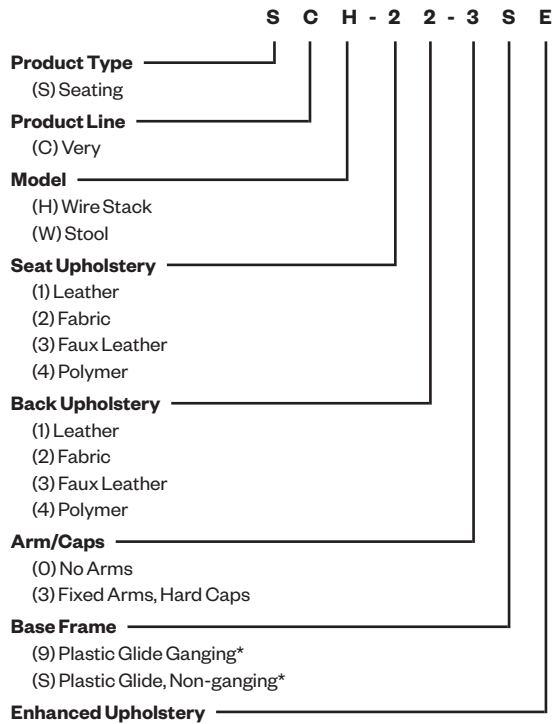

\*Wire Stacker Chair only

# Very Wire Stacker



SCH-44-3S



SCH-44-OS  
Class VY

### Features

- 11 mm steel rod frame.
- Single high-strength polymer shell seat and back with an optional upholstery pad.
- Upholstered seat features 0.5"(13mm) foam pad.
- Upholstered back features 0.5"(13mm) foam pad.
- Arms: Black or Fog glass-filled polypropylene arm caps.
- Frame: Available painted or trivalent chrome.
- High impact clear nylon glides available with or without ganging option.
- Stacking:
  - With Arms: Stacks 5-high on the floor or 15-high on a cart.
  - Without Arms: Stacks 10-high on the floor, upholstered or non-upholstered; stacks 30-high non-upholstered on a cart; stacks 25-high upholstered on a cart.
- Ganging option: Arm to armless, armless to armless.
- COM yardage / COL square footage:
  - Fully Upholstered: 1.5/17.0
  - Upholstered seat: 0.8/10.6

### Dimensions

Height:	Depth:	Width:
H: 30.6"(777mm)	D: 23.3"(592mm)	W: 23"(584mm)
*SH: 17.3"(439mm)	*SD: 17.3"(439mm)	*SW: 18.8"(478mm)
*AH: 8.5"(216mm)		
Between Arms: 19.2"(488mm)		

\*Measurements taken with the BIFMA chair measuring device.

### To Order, Specify:

1) Product number, including:

#### 1 Seat or Seat Pad Option:

- 1 Leather
- 2 Fabric
- 3 Faux Leather
- 4 Polymer

#### 2 Back or Back Pad Option:

- 1 Leather
- 2 Fabric
- 3 Faux Leather
- 4 Polymer

- 2) Fabric surface and color (seat).
- 3) Fabric surface and color (back).
- 4) Shell color - required for upholstered and non-upholstered.
- 5) Trim for arm caps (if applicable).
- 6) Frame trim color.

Ganging	Arm	Number		Price	Fabric								Leather	
		1	2		A	B	C	D	E	F	G	H	A	B
<b>Polymer Shell Without Optional Upholstered Pad</b>														
Non-Ganging	Arms	SCH-44-3S		\$485.08	N/A	N/A	N/A	N/A	N/A	N/A	N/A	N/A	N/A	N/A
	No Arms	SCH-44-OS		378.66	N/A	N/A	N/A	N/A	N/A	N/A	N/A	N/A	N/A	N/A
Ganging Glide	Arms	SCH-44-39		503.49	N/A	N/A	N/A	N/A	N/A	N/A	N/A	N/A	N/A	N/A
	No Arms	SCH-44-09		397.07	N/A	N/A	N/A	N/A	N/A	N/A	N/A	N/A	N/A	N/A
<b>Polymer Shell With Upholstered Seat Pad</b>														
Non-Ganging	Arms	SCH-4-3SE		N/A	\$620.77	\$680.16	\$743.57	\$772.25	\$798.81	\$852.06	\$903.21	\$1038.32	\$895.03	\$1140.31
	No Arms	SCH-4-0SE		N/A	514.35	573.74	637.15	665.83	692.39	745.64	796.79	931.90	788.61	1033.89
Ganging Glide	Arms	SCH-4-39E		N/A	639.18	698.57	761.98	790.66	817.22	870.47	921.62	1056.73	913.44	1158.72
	No Arms	SCH-4-09E		N/A	532.76	592.15	655.56	684.24	710.80	764.05	815.20	950.31	807.02	1052.30
<b>Polymer Shell With Upholstered Seat and Back Pads</b>														
Non-Ganging	Arms	SCH-4-3SE		N/A	\$745.35	\$864.13	\$990.95	\$1048.31	\$1101.43	\$1207.93	\$1310.23	\$1580.45	\$1293.87	\$1784.43
	No Arms	SCH-4-0SE		N/A	638.93	757.71	884.53	941.89	995.01	1101.51	1203.81	1474.03	1187.45	1678.01
Ganging Glide	Arms	SCH-4-39E		N/A	763.76	882.54	1009.36	1066.72	1119.84	1226.34	1328.64	1598.86	1312.28	1802.84
	No Arms	SCH-4-09E		N/A	657.34	776.12	902.94	960.30	1013.42	1119.92	1222.22	1492.44	1205.86	1696.42

The following options require modification of the product number.

Stain repellent

To specify, add **P** to end of the product number (add **\$62.54** list).

**Note:** Stain repellent is available on SCH-22 or SCH-24 models only. For available fabrics, refer to [surfaces.haworth.com](http://surfaces.haworth.com).

# Very

## Bar Height Wire Stool

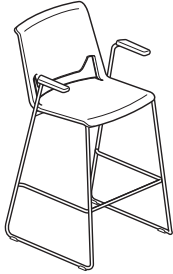

SCW-44-3S

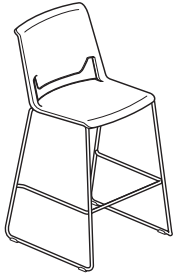

SCW-44-OS  
Class VY

### Features

- 11 mm steel rod frame.
- Single piece high-strength polymer shell seat and back with an optional upholstery pad.
- 10 shell color options.
- Upholstered seat features 0.5"(13mm) foam pad.
- Upholstered back features 0.5"(13mm) foam pad.
- Arms: Black or Fog glass-filled polypropylene arm caps.
- Base: trivalent chrome.
- High impact clear nylon glides.
- Stacks 5-high on the floor.
- The foot rest is 11.84"(301mm) from the floor.
- COM yardage / COL square footage:  
Fully Upholstered: 1.5/12.5  
Upholstered seat: .8/7.5

### Dimensions

Height: 43"(1092mm)      Depth: 23"(584mm)      Width: 23"(584mm)  
 H: 43"(1092mm)      D: 23"(584mm)      W: 23"(584mm)  
 \*SH: 29.75"(756mm)      \*SD: 17.3"(439mm)      \*SW: 18.68"(474mm)  
 \*AH: 8.5"(216mm)  
 Between Arms: 19.2"(488mm)

\*Measurements taken with the BIFMA chair measuring device.

### To Order, Specify:

1) Product number.

#### 1 Seat or Seat Pad Option:

- 1 Leather
- 2 Fabric
- 3 Faux Leather
- 4 Polymer

#### 2 Back or Back Pad Option:

- 1 Leather
- 2 Fabric
- 3 Faux Leather
- 4 Polymer

- 2) Fabric surface and color (seat).
- 3) Fabric surface and color (back).
- 4) Shell color - required for upholstered and non-upholstered.
- 5) Trim for arm caps (if specified).
- 6) Frame trim color (KR-V only).

Description	Number ① ②	Price	Fabric								Leather	
			A	B	C	D	E	F	G	H	A	B
<b>Polymer Shell Without Optional Upholstered Pad</b>												
With Arms	SCW-44-3S	\$822.77	N/A	N/A	N/A	N/A	N/A	N/A	N/A	N/A	N/A	N/A
Without Arms	SCW-44-OS	716.35	N/A	N/A	N/A	N/A	N/A	N/A	N/A	N/A	N/A	N/A
<b>Polymer Shell With Upholstered Seat Pad</b>												
With Arms	SCW-4-3SE	N/A	\$ 958.46	\$ 1017.85	\$ 1081.26	\$ 1109.94	\$ 1136.50	\$ 1189.75	\$ 1240.90	\$ 1376.01	\$ 1232.72	\$ 1478.00
Without Arms	SCW-4-OSE	N/A	852.04	911.43	974.84	1003.52	1030.08	1083.33	1134.48	1269.59	1126.30	1371.58
<b>Polymer Shell With Upholstered Seat and Back Pads</b>												
With Arms	SCW-4-3SE	N/A	\$1083.04	\$ 1201.82	\$ 1328.64	\$ 1386.00	\$ 1439.12	\$ 1545.62	\$ 1647.92	\$ 1918.14	\$ 1631.56	\$ 2122.12
Without Arms	SCW-4-OSE	N/A	976.62	1095.40	1222.22	1279.58	1332.70	1439.20	1541.50	1811.72	1525.14	2015.70

The following options require modification of the product number.

Stain repellent

To specify, add **P** to end of the product number (add **\$62.54** list).

**Note:** Stain repellent is available on SCW-22 or SCW-24 models only. For available fabrics, refer to [surfaces.haworth.com](http://surfaces.haworth.com).

# Very Counter Height Wire Stool

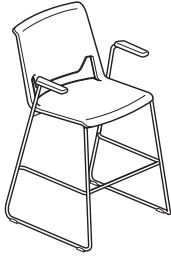

SCWC-44-3S

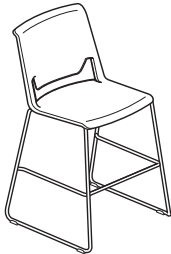

SCWC-44-0S  
Class VY

### Features

- 11 mm steel rod frame.
- Single piece high-strength polymer shell seat and back with an optional upholstery pad.
- 10 shell color options.
- Upholstered seat features 0.5"(13mm) foam pad.
- Upholstered back features 0.5"(13mm) foam pad.
- Arms: Black or Fog glass-filled polypropylene arm caps.
- Base: trivalent chrome.
- High impact clear nylon glides.
- Stacks 5-high on the floor.
- The foot rest is 7.84"(199mm) from the floor.
- COM yardage / COL square footage:  
Fully Upholstered: 1.5/12.5  
Upholstered seat: .8/7.5

### Dimensions

Height:	Depth:	Width:
H: 39"(991mm)	D: 23"(584mm)	W: 23"(584mm)
*SH: 25.75"(654mm)	*SD: 17.3"(439mm)	*SW: 18.68"(474mm)
*AH: 8.5"(216mm)		
Between Arms: 19.2"(488mm)		

\*Measurements taken with the BIFMA chair measuring device.

### To Order, Specify:

1) Product number.

#### 1 Seat or Seat Pad Option:

- 1 Leather
- 2 Fabric
- 3 Faux Leather
- 4 Polymer

#### 2 Back or Back Pad Option:

- 1 Leather
- 2 Fabric
- 3 Faux Leather
- 4 Polymer

- 2) Fabric surface and color (seat).
- 3) Fabric surface and color (back).
- 4) Shell color - required for upholstered and non-upholstered.
- 5) Trim for arm caps (if specified).
- 6) Frame trim color (KR-V only).

Description	Number ① ②	Price	Fabric								Leather	
			A	B	C	D	E	F	G	H	A	B
<b>Polymer Shell Without Optional Upholstered Pad</b>												
With Arms	SCWC-44-3S	\$822.77	N/A	N/A	N/A	N/A	N/A	N/A	N/A	N/A	N/A	N/A
Without Arms	SCWC-44-0S	716.35	N/A	N/A	N/A	N/A	N/A	N/A	N/A	N/A	N/A	N/A
<b>Polymer Shell With Upholstered Seat Pad</b>												
With Arms	SCWC-4-3SE	N/A	\$ 958.46	\$ 1017.85	\$ 1081.26	\$ 1109.94	\$ 1136.50	\$ 1189.75	\$ 1240.90	\$ 1376.01	\$ 1232.72	\$ 1478.00
Without Arms	SCWC-4-0SE	N/A	852.04	911.43	974.84	1003.52	1030.08	1083.33	1134.48	1269.59	1126.30	1371.58
<b>Polymer Shell With Upholstered Seat and Back Pads</b>												
With Arms	SCWC-4-3SE	N/A	\$ 1083.04	\$ 1201.82	\$ 1328.64	\$ 1386.00	\$ 1439.12	\$ 1545.62	\$ 1647.92	\$ 1918.14	\$ 1631.56	\$ 2122.12
Without Arms	SCWC-4-0SE	N/A	976.62	1095.40	1222.22	1279.58	1332.70	1439.20	1541.50	1811.72	1525.14	2015.70

The following options require modification of the product number.

Stain repellent

To specify, add **P** to end of the product number (add **\$62.54** list).

**Note:** Stain repellent is available on SCWC-22 or SCWC-24 models only. For available fabrics, refer to [surfaces.haworth.com](http://surfaces.haworth.com).

# Very Perforated Side, Seminar and Side Stool

## At-A-Glance

### Features and Options (Side, Seminar and Side Chair)

#### Side and Seminar Chair

- Back: High-strength polymer back with perforations for added flexibility and an optional upholstered foam pad
- Seat: High-strength polymer seat with an optional upholstered foam pad
- Casters: Hard (black), soft (black) or two-tone (fog and gray)
- Glides: Plastic or felt
- Frame finishes include: painted or trivalent chrome
- Weight assisted recline mechanism (Seminar model only)
- Fog or black trim arm caps and glides available
- Arm or armless version available
- Optional Laminated Tablet arm
- Optional Storage rack
- Stacking cart (8-high capacity)
- Stacks 5-high on the floor or 8-high non-upholstered and 6-high upholstered (arms - 69"(1753mm)H x 46"(1168mm)D x 24"(610mm)W), (armless - 57"(1448mm)H x 44"(1118mm)D x 24"(610mm)W) on cart.
- 22mm 14-gauge steel leg tube
- Seminar Chair with intuitive reclining back.

#### Side Stool

- Back: High-strength polymer back with perforations for added flexibility and an optional upholstered foam pad
- Seat: High-strength polymer seat with an optional upholstered polyurethane foam pad
- Glides: Plastic or felt
- Frame finishes include: painted or trivalent chrome
- Fog or black trim arm caps and glides available
- Arm or armless version available
- Stacks 5-high on the floor

### Specifications

Designed for use by individuals up to 325 lbs.

### Catalog Logic

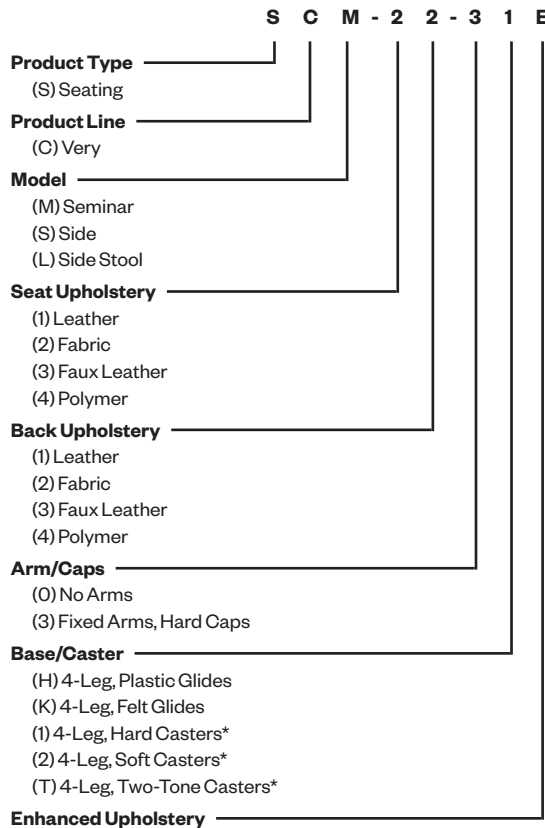

\*Side and Seminar chairs only.

# Very

## Side Chair — Perforated Back

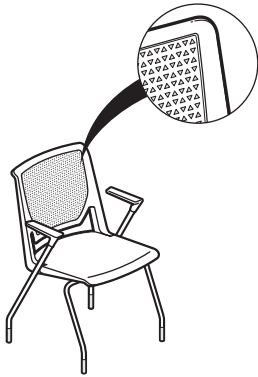

SCS-44-3H

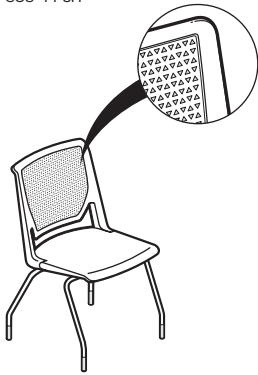

SCS-44-0H  
Class VY

### Features

- Back: High-strength polymer back with flexing perforations and an optional upholstered foam pad.
- Seat: High-strength polymer seat with an optional upholstery pad.
- Upholstered seat features 1"(25mm) foam pad.
- Upholstered back features 0.5"(13mm) foam pad.
- Arms: Black or Fog glass-filled polypropylene arm caps.
- Frame: Available painted or trivalent chrome.
- Casters: Hard (black), soft (black) or two-tone (fog and gray).
- Glides: Plastic or felt.
- Stacks 5-high on the floor and 8-high non-upholstered or 6-high upholstered on a cart with glides and casters.
- COM yardage / COL square footage:  
Fully Upholstered: 1.5/17.0  
Upholstered seat: 0.75/9.5

### Dimensions

Height:	Depth:	Width:
H: 33.9"(861mm)	D: 22"(559mm)	W: 23.5"(597mm)
*SH: 18.2"(462mm)	*SD: 17.5"(445mm)	*SW: 19.2"(488mm)
*AH: 8.9"(226mm)		
Between Arms: 19.6"(498mm)		

\*Measurements taken with the BIFMA chair measuring device.

### To Order, Specify:

1) Product number, including:

#### 1 Seat or Seat Pad Option:

- 1 Leather
- 2 Fabric
- 3 Faux Leather
- 4 Polymer

#### 2 Back or Back Pad Option:

- 1 Leather
- 2 Fabric
- 3 Faux Leather
- 4 Polymer

#### 3 Glide or Caster Option:

- H Plastic Glide
- K Felt Glide
- 1 Hard Casters (add **\$72.64** list)
- 2 Soft Casters (add **\$138.79** list)
- T Two-Tone Casters (add **\$72.64** list)

- 2) Fabric surface and color (seat).
- 3) Fabric surface and color (back).
- 4) Shell color – required for upholstered and non-upholstered.
- 5) Trim for arm caps, glides and plastic components.
- 6) Frame trim color.  
Trivalent Chrome (KR-V) (add **\$312.70** list)

Description	Number			Price	Fabric						Leather			
	1	2	3		A	B	C	D	E	F	G	H	A	B
<b>Without Optional Upholstered Pad</b>														
With Arms	SCS-44-3			\$560.85	N/A	N/A	N/A	N/A	N/A	N/A	N/A	N/A	N/A	N/A
Without Arms	SCS-44-0			455.94	N/A	N/A	N/A	N/A	N/A	N/A	N/A	N/A	N/A	N/A
<b>With Upholstered Seat Pad</b>														
With Arms	SCS-		-3	E	N/A	\$695.94	\$754.46	\$817.01	\$845.24	\$871.43	\$923.94	\$974.34	\$1107.52	\$1208.05
Without Arms	SCS-		-0	E	N/A	591.03	649.55	712.10	740.33	766.52	819.03	869.43	1002.61	1103.14
<b>With Upholstered Seat and Back Pads</b>														
With Arms	SCS-		-3	E	N/A	\$821.88	\$938.92	\$1064.02	\$1120.48	\$1172.86	\$1277.88	\$1378.68	\$1645.04	\$1846.10
Without Arms	SCS-		-0	E	N/A	716.97	834.01	959.11	1015.57	1067.95	1172.97	1273.77	1540.13	1741.19

The following options require modification of the product number.

Stain repellent

To specify, add **P** to end of the product number (add **\$62.54** list).

**Note:** Stain repellent is available on SCS-22 and SCS-24 models only. For available fabrics, refer to [surfaces.haworth.com](http://surfaces.haworth.com).

# Very

## Side Chair with Tablet Arm — Perforated Back



SCS-44-RH  
Class VY

### Features

- Back: High-strength polymer back with flexing perforations and an optional upholstery pad.
- Seat: High-strength polymer with an optional upholstery pad.
- Upholstered seat features 1" (25mm) foam pad.
- Upholstered back features 0.5" (13mm) foam pad.
- Arm cap: Black.
- Tablet assembly painted black.
- Clearance from tablet to chair back 12.5" (318mm) - 15.5" (394mm) angled.
- High-pressure laminate (HPL) tablet top with matching underside flips up and folds away when not in use.
- Left or right-hand configurations.
- Tablet arm size: 15" (381mm)W x 9.8" (249mm)D (Sized to accommodate laptops).
- Base: available painted or optional trivalent chrome.
- Glides or Casters.
- Standard with hard casters, black or two-tone.
- Optional black soft casters.
- COM yardage / COL square footage:  
Fully Upholstered: 1.5/13  
Upholstered seat: 0.75/7.25

### Dimensions

Height:	Depth:	Width:
H: 33.9" (861mm)	D: 22" (559mm)	W: 23.5" (597mm)
*SH: 18.23" (463mm)	*SD: 17.5" (445mm)	*SW: 19.2" (488mm)

\*Measurements taken with the BIFMA chair measuring device.

### To Order, Specify:

- Product number.
  - 1 Seat or Seat Pad Option:**
    - Leather
    - Fabric
    - Faux Leather
    - Polymer
  - 2 Back or Back Pad Option:**
    - Leather
    - Fabric
    - Faux Leather
    - Perforated Polymer
  - 3 Tablet Option:**
    - R Right-Hand Tablet Arm
    - L Left-Hand Tablet Arm
  - 4 Glide or Caster Option:**
    - H Plastic Glide
    - K Felt Glide
    - 1 Hard Casters (add **\$72.64** list)
    - 2 Soft Casters (add **\$138.79** list)
    - T Two-Tone Hard Casters (add **\$72.64** list)
- Fabric surface and color (seat).
  - Fabric surface and color (back).
  - Shell color - required for upholstered and non-upholstered.
  - Trim for arm caps (if specified) and glides.
  - Frame trim color.  
Trivalent Chrome (KR-V) (add **\$312.70** list)
  - Laminate for tablet (if specified).

Description	Number ①②③④	Price	Fabric					Leather					
			A	B	C	D	E	F	G	H	A	B	
<b>Without Optional Upholstered Pad</b>													
	SCS-44-■ ■	\$808.98	N/A	N/A	N/A	N/A	N/A	N/A	N/A	N/A	N/A	N/A	N/A
<b>With Upholstered Seat Pad</b>													
	SCS-■ 4-■ ■ E	N/A	\$944.07	\$1002.59	\$1065.14	\$1093.37	\$1119.56	\$1172.07	\$1222.47	\$1355.65	\$1214.41	\$1456.18	
<b>With Upholstered Seat and Back Pads</b>													
	SCS-■ ■ - ■ ■ E	N/A	\$1070.01	\$1187.05	\$1312.15	\$1368.61	\$1420.99	\$1473.50	\$1626.81	\$1893.17	\$1610.69	\$2094.23	

The following options require modification of the product number.

Stain repellent

To specify, add **P** to end of the product number (add **\$62.54** list); **Example:** SCS-22-RHEP

# Very

## Side Chair with Storage Rack — Perforated Back



SCK-44-3H  
Class VY

### Features

- Back: High-strength polymer back with flexing perforations and an optional upholstery pad.
- Seat: Injection-molded with an optional upholstery pad.
- Upholstered seat features 1" (25mm) foam pad.
- Upholstered back features 0.5" (13mm) foam pad.
- Storage rack ships unassembled (chrome only).
- Arms: Black or Fog arm caps when no tablet is specified.
- Optional Tablet arm:
  - Tablet assembly painted black.
  - Flips up and fold away laminate tablet with matching laminate underside.
  - Left or right-hand configurations.
  - Tablet arm size: 15" (381mm)W x 9.8" (249mm)D (Sized to accommodate laptops).
- Base: available painted or optional trivalent chrome.
- Glides or Casters: Standard with hard casters, black or two-tone.
- Optional black soft casters.
- COM yardage / COL square footage:
  - Fully Upholstered: 1.5/13
  - Upholstered seat: 0.75/7.25

### Dimensions

Height:	Depth:	Width:
H: 33.9" (861mm)	D: 22" (559mm)	W: 23.5" (597mm)
*SH: 18.2" (462mm)	*SD: 17.5" (445mm)	*SW: 19.2" (488mm)
*AH: 8.9" (226mm)		
Between Arms: 19.6" (498mm)		

\*Measurements taken with the BIFMA chair measuring device.

### To Order, Specify:

- Product number.
  - 1 Seat or Seat Pad Option:**
    - Leather
    - Fabric
    - Faux Leather
    - Polymer
  - 2 Back or Back Pad Option:**
    - Leather
    - Fabric
    - Faux Leather
    - Perforated Polymer
  - 3 Arm Option:**
    - R** Right-Hand Tablet Arm (add **\$353.04** list)
    - L** Left-Hand Tablet Arm (add **\$353.04** list)
    - 0** No Arms
    - 3** Fixed Arm, Hard Caps (add **\$101.85** list)
  - 4 Glide or Caster Option:**
    - H** Plastic Glide
    - K** Felt Glide
    - 1** Hard Casters (add **\$72.64** list)
    - 2** Soft Casters (add **\$138.79** list)
    - T** Two-Tone Casters (add **\$72.64** list)
- Fabric surface and color (seat).
  - Fabric surface and color (back).
  - Shell color - required for upholstered and non-upholstered.
  - Trim for arm caps (if specified) and glides.
  - Frame trim color.
    - Trivalent Chrome (KR-V) (add **\$312.70** list)
  - Laminate for tablet (if specified).

Description	Number ①②③④	Price	Fabric						Leather			
			A	B	C	D	E	F	G	H	A	B
<b>Without Optional Upholstered Pad</b>												
SCK-44-	■ ■	\$587.07	N/A	N/A	N/A	N/A	N/A	N/A	N/A	N/A	N/A	N/A
<b>With Upholstered Seat Pad</b>												
SCK-	■ 4- ■ ■ E	N/A	\$722.16	\$780.68	\$843.23	\$871.46	\$897.65	\$950.16	\$1000.56	\$1133.74	\$992.50	\$1234.27
<b>With Upholstered Seat and Back Pads</b>												
SCK-	■ ■ - ■ ■ E	N/A	\$848.10	\$965.14	\$1090.24	\$1146.70	\$1199.08	\$1304.10	\$1404.90	\$1671.26	\$1388.78	\$1872.32

The following options require modification of the product number.

Stain repellent

To specify, add **P** to end of the product number (add **\$62.54** list); **Example:** SCK-22-RHEP

# Very

## Bar Height Side Stool — Perforated Back

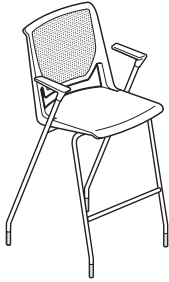

SCL-44-3H

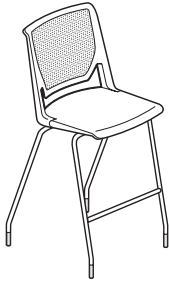

SCL-44-0H  
Class VY

### Features

- Back options: High-strength polymer with flexing perforations and an optional upholstery pad.
- Seat: Injection-molded high-strength polymer seat with an optional upholstery pad.
- Upholstered seat features 1"(25mm) foam pad.
- Upholstered back features 0.5"(13mm) foam pad.
- Arms: Black or Fog high-strength polymer arm caps.
- Base: available painted or optional trivalent chrome.
- Standard with glides.
- Stacks 5 high on the floor.
- COM yardage / COL square footage:  
Fully Upholstered: 1.5/13  
Upholstered seat: 0.75/7.25

### Dimensions

Height:	Depth:	Width:
H: 46.25"(1175mm)	D: 23"(584mm)	W: 23.75"(603mm)
*SH: 29.75"(756mm)	*SD: 17.2"(437mm)	*SW: 18.75"(476mm)
*AH: 8.9"(226mm)		
Between Arms: 19.6"(498mm)		

\*Measurements taken with the BIFMA chair measuring device.

### To Order, Specify:

1) Product number.

#### 1 Seat or Seat Pad Option:

- 1 Leather
- 2 Fabric
- 3 Faux Leather
- 4 Polymer

#### 2 Back or Back Pad Option:

- 1 Leather
- 2 Fabric
- 3 Faux Leather
- 4 Perforated Polymer

#### 3 Glide Option:

- H Plastic Glide
- K Felt Glide

- 2) Fabric surface and color (seat).
- 3) Fabric surface and color (back).
- 4) Shell color - required for upholstered and non-upholstered.
- 5) Trim for arm caps (if specified) and glides.
- 6) Frame trim color.  
Trivalent Chrome (KR-V)  
(add **\$312.70** list)

Description	Number ①②③	Price	Fabric								Leather	
			A	B	C	D	E	F	G	H	A	B
<b>Without Optional Upholstered Pad</b>												
With Arms	SCL-44-3	\$ 1164.06	N/A	N/A	N/A	N/A	N/A	N/A	N/A	N/A	N/A	N/A
Without Arms	SCL-44-0	1059.15	N/A	N/A	N/A	N/A	N/A	N/A	N/A	N/A	N/A	N/A
<b>With Upholstered Seat Pad</b>												
With Arms	SCL-4-3 E	N/A	\$1299.15	\$1357.67	\$1420.22	\$1448.45	\$1474.64	\$1527.15	\$1577.55	\$1710.73	\$1569.49	\$1811.26
Without Arms	SCL-4-0 E	N/A	1194.24	1252.76	1315.31	1343.54	1369.73	1422.24	1472.64	1605.82	1464.58	1706.35
<b>With Upholstered Seat and Back Pads</b>												
With Arms	SCL-4-3 E	N/A	\$1425.09	\$1542.13	\$1667.23	\$1723.69	\$1776.07	\$1881.09	\$1981.89	\$2248.25	\$1965.77	\$2449.31
Without Arms	SCL-4-0 E	N/A	1320.18	1437.22	1562.32	1618.78	1671.16	1776.18	1876.98	2143.34	1860.86	2344.40

The following options require modification of the product number.

Stain repellent

To specify, add **P** to end of the product number (add **\$62.54** list); **Example:** SCL-22-3HEP

**Note:** Stain repellent is available on SCL-22 or SCL-24 models only. For available fabrics, refer to [surfaces.haworth.com](http://surfaces.haworth.com).

# Very

## Counter Height Side Stool — Perforated Back

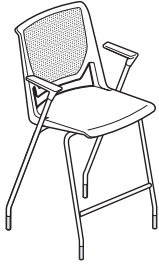

SCLC-44-3H

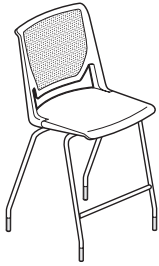

SCLC-44-0H  
Class VY

### Features

- Back options: High-strength polymer with flexing perforations and an optional upholstery pad.
- Seat: Injection-molded high-strength polymer seat with an optional upholstery pad.
- Upholstered seat features 1"(25mm) foam pad.
- Upholstered back features 0.5"(13mm) foam pad.
- Arms: Black or Fog high-strength polymer arm caps.
- Base: available painted or optional trivalent chrome.
- Standard with glides.
- Stacks 5 high on the floor.
- COM yardage / COL square footage:  
Fully Upholstered: 1.5/13  
Upholstered seat: 0.75/7.25

### Dimensions

Height: H: 42.25"(1073mm)      Depth: D: 21.7"(551mm)      Width: W: 23.75"(603mm)  
 \*SH: 25.75"(654mm)      \*SD: 17.2"(437mm)      \*SW: 18.75"(476mm)  
 \*AH: 8.9"(226mm)  
 Between Arms: 19.6"(498mm)

\*Measurements taken with the BIFMA chair measuring device.

### To Order, Specify:

1) Product number.

#### 1 Seat or Seat Pad Option:

- 1 Leather
- 2 Fabric
- 3 Faux Leather
- 4 Polymer

#### 2 Back or Back Pad Option:

- 1 Leather
- 2 Fabric
- 3 Faux Leather
- 4 Perforated Polymer

#### 3 Glide Option:

- H Plastic Glide
- K Felt Glide

- 2) Fabric surface and color (seat).
- 3) Fabric surface and color (back).
- 4) Shell color - required for upholstered and non-upholstered.
- 5) Trim for arm caps (if specified) and glides.
- 6) Frame trim color.  
Trivalent Chrome (KR-V)  
(add **\$312.70** list)

Description	Number ①②③	Price	Fabric				Leather					
			A	B	C	D	E	F	G	H	A	B
<b>Without Optional Upholstered Pad</b>												
With Arms	SCLC-44-3	\$ 1164.06	N/A	N/A	N/A	N/A	N/A	N/A	N/A	N/A	N/A	N/A
Without Arms	SCLC-44-0	1059.15	N/A	N/A	N/A	N/A	N/A	N/A	N/A	N/A	N/A	N/A
<b>With Upholstered Seat Pad</b>												
With Arms	SCLC-4-3 E	N/A	\$1299.15	\$1357.67	\$1420.22	\$1448.45	\$1474.64	\$1527.15	\$1577.55	\$1710.73	\$1569.49	\$1811.26
Without Arms	SCLC-4-0 E	N/A	1194.24	1252.76	1315.31	1343.54	1369.73	1422.24	1472.64	1605.82	1464.58	1706.35
<b>With Upholstered Seat and Back Pads</b>												
With Arms	SCLC-4-3 E	N/A	\$1425.09	\$1542.13	\$1667.23	\$1723.69	\$1776.07	\$1881.09	\$1981.89	\$2248.25	\$1965.77	\$2449.31
Without Arms	SCLC-4-0 E	N/A	1320.18	1437.22	1562.32	1618.78	1671.16	1776.18	1876.98	2143.34	1860.86	2344.40

The following options require modification of the product number.

Stain repellent

To specify, add **P** to end of the product number (add **\$62.54** list); **Example:** SCLC-22-3HEP

**Note:** Stain repellent is available on SCLC-22 or SCLC-24 models only. For available fabrics, refer to [surfaces.haworth.com](http://surfaces.haworth.com).

# Very Seminar Chair — Perforated Back

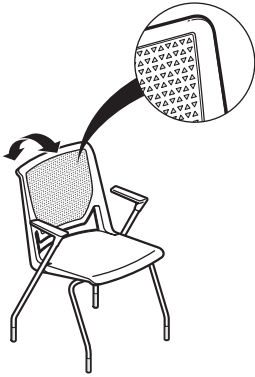

SCM-44-3H

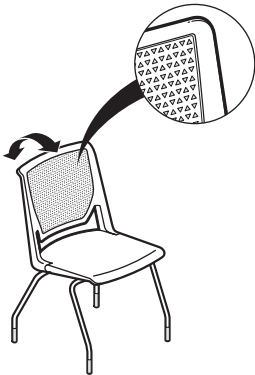

SCM-44-0H  
Class VY

### Features

- Back: High-strength polymer back with flexing perforations and an optional upholstered foam pad.
- Seat: High-strength polymer seat with an optional upholstery pad.
- Weight assisted recline mechanism.
- Upholstered seat features 1"(25mm) foam pad.
- Upholstered back features 0.5"(13mm) foam pad.
- Arms: Black or Fog glass-filled polypropylene arm caps.
- Frame: Available painted or trivalent chrome.
- Casters: Hard (black), soft (black) or two-tone (fog and gray).
- Glides: Plastic or felt.
- Stacks 5-high on the floor and 8-high non-upholstered and 6-high upholstered on a cart with glides and casters.
- COM yardage / COL square footage:  
Fully Upholstered: 1.5/17  
Upholstered seat: 0.75/9.5

### Dimensions

Height:	Depth:	Width:
H: 33.9"(861mm)	D: 22"(559mm)	W: 23.5"(597mm)
*SH: 18.2"(462mm)	*SD: 17.5"(445mm)	*SW: 19.2"(488mm)
*AH: 8.9"(226mm)		
Between Arms: 19.6"(498mm)		

\*Measurements taken with the BIFMA chair measuring device.

### To Order, Specify:

1) Product number, including:

#### 1 Seat or Seat Pad Option:

- 1 Leather
- 2 Fabric
- 3 Faux Leather
- 4 Polymer

#### 2 Back or Back Pad Option:

- 1 Leather
- 2 Fabric
- 3 Faux Leather
- 4 Polymer

#### 3 Glide or Caster Option:

- H Plastic Glide
- K Felt Glide
- 1 Hard Casters (add **\$72.64** list)
- 2 Soft Casters (add **\$138.79** list)
- T Two-Tone Casters (add **\$72.64** list)

- 2) Fabric surface and color (seat).
- 3) Fabric surface and color (back).
- 4) Shell color – required for upholstered and non-upholstered.
- 5) Trim for arm caps, glides, and plastic components.
- 6) Frame trim color.  
Trivalent Chrome (KR-V)  
(add **\$312.70** list)

Description	Number ① ② ③	Price	Fabric								Leather	
			A	B	C	D	E	F	G	H	A	B
<b>Without Optional Upholstered Pad</b>												
With Arms	SCM-44-3	\$966.37	N/A	N/A	N/A	N/A	N/A	N/A	N/A	N/A	N/A	N/A
Without Arms	SCM-44-0	1214.50	N/A	N/A	N/A	N/A	N/A	N/A	N/A	N/A	N/A	N/A
<b>With Upholstered Seat Pad</b>												
With Arms	SCM-44-3-E	N/A	\$ 1137.63	\$ 1196.15	\$ 1258.70	\$ 1286.93	\$ 1313.12	\$ 1365.63	\$ 1416.03	\$ 1549.21	\$ 1407.97	\$ 1649.74
Without Arms	SCM-44-0-E	N/A	1385.76	1444.28	1506.83	1535.06	1561.25	1613.76	1664.16	1797.34	1656.10	1897.87
<b>With Upholstered Seat and Back Pads</b>												
With Arms	SCM-44-3-E	N/A	\$ 1269.06	\$ 1386.10	\$ 1511.20	\$ 1567.66	\$ 1620.04	\$ 1725.06	\$ 1825.86	\$ 2092.22	\$ 1809.74	\$ 2293.28
Without Arms	SCM-44-0-E	N/A	1517.19	1634.23	1759.33	1815.79	1868.17	1973.19	2073.99	2340.35	2057.87	2541.41

The following options require modification of the product number.

Stain repellent

To specify, add **P** to end of the product number (add **\$62.54** list).

**Note:** Stain repellent is available on SCM-22 and SCM-24 models only. For available fabrics, refer to [surfaces.haworth.com](http://surfaces.haworth.com).

# Very Seminar with Storage Rack — Perforated Back



SCB-44-3H

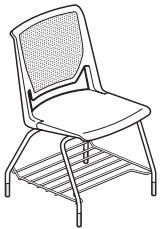

SCB-44-0H  
Class VY

### Features

- Back: High-strength polymer back with flexing perforations and an optional upholstery pad.
- Seat: High-strength polymer seat with an optional upholstery pad.
- Weight assisted recline mechanism.
- Upholstered seat features 1"(25mm) foam pad.
- Upholstered back features 0.5"(13mm) foam pad.
- Arms: Black or Fog arm caps.
- Storage rack available in Chrome only.
- Tablet assembly painted black.
- High-pressure laminate (HPL) tablet top with matching underside flips up and folds away when not in use.
- Left or right-hand configurations.
- Tablet arm size: 15"(381mm)W x 9.8"(249mm)D (Sized to accommodate laptops).
- Ships with chair, unassembled.
- Base: available painted or optional trivalent chrome.
- Glides or Casters: Standard with hard casters, black or two-tone.
- Optional black soft casters.
- COM yardage / COL square footage:  
Fully Upholstered: 1.5/13  
Upholstered seat: 0.75/7.25

### Dimensions

Height:	Depth:	Width:
H: 33.9"(861mm)	D: 22"(559mm)	W: 23.5"(597mm)
*SH: 18.2"(462mm)	*SD: 17.5"(445mm)	*SW: 19.2"(488mm)
*AH: 8.9"(226mm)		
Between Arms: 19.6"(498mm)		

\*Measurements taken with the BIFMA chair measuring device.

### To Order, Specify:

- Product number.
  - 1 Seat or Seat Pad Option:**
    - Leather
    - Fabric
    - Faux Leather
    - Polymer Back or Back Pad
  - 2 Back or Back Pad Option:**
    - Leather
    - Fabric
    - Faux Leather
    - Perforated Polymer
  - 3 Arm Option:**
    - R** Right-Hand Tablet Arm (add **\$353.04** list)
    - L** Left-Hand Tablet Arm (add **\$353.04** list)
    - 0** No Arms
    - 3** Fixed Arm, Hard Caps (add **\$101.85** list)
  - 4 Glide or Caster Option:**
    - H** Plastic Glide
    - K** Felt Glide
    - 1** Hard Casters (add **\$72.64** list)
    - 2** Soft Casters (add **\$138.79** list)
    - T** Two-Tone Casters (add **\$72.64** list)
- Fabric surface and color (seat).
  - Fabric surface and color (back).
  - Shell color - required for upholstered and non-upholstered.
  - Trim for arm caps (if specified) and glides.
  - Frame trim color.  
Trivalent Chrome (KR-V) (add **\$312.70** list)

Description	Number ①②③④	Price	Fabric							Leather		
			A	B	C	D	E	F	G	H	A	B
<b>Without Optional Upholstered Pad</b>												
SCB-44-	■ ■	\$992.59	N/A	N/A	N/A	N/A	N/A	N/A	N/A	N/A	N/A	N/A
<b>With Upholstered Seat Pad</b>												
SCB-	■ 4- ■ ■ E	N/A	\$1163.85	\$1222.37	\$1284.92	\$1313.15	\$1339.34	\$1391.85	\$1442.25	\$1575.43	\$1434.19	\$1675.96
<b>With Upholstered Seat and Back Pads</b>												
SCB-	■ ■ - ■ ■ E	N/A	\$1295.28	\$1412.32	\$1537.42	\$1593.88	\$1646.26	\$1751.28	\$1852.08	\$2118.44	\$1835.96	\$2319.50

The following options require modification of the product number.

Stain repellent

To specify, add **P** to end of the product number (add **\$62.54** list); **Example:** SCB-22-RHEP

# Very Perforated Conference Chair and Conference Stool

## At-A-Glance

### Features and Options (Conference Chair and Conference Stool)

- Back: High-strength polymer back with flexing perforations and an optional upholstered foam pad
- Seat: High-strength polymer seat with an optional upholstered polyurethane foam pad
- Five-star base with casters: hard (black), soft (black) or two-tone (fog and gray)
- Base: painted aluminum, polished aluminum or plastic (fog or black)
- Frame finishes include: painted or polished aluminum
- Weight assisted recline mechanism
- Pneumatic height adjustment
- Fog or black trim arm caps
- Arm or armless version available
- Adjustable footring in brushed aluminum (stool only)

### Specifications

Designed for use by individuals up to 325 lbs.

### Catalog Logic

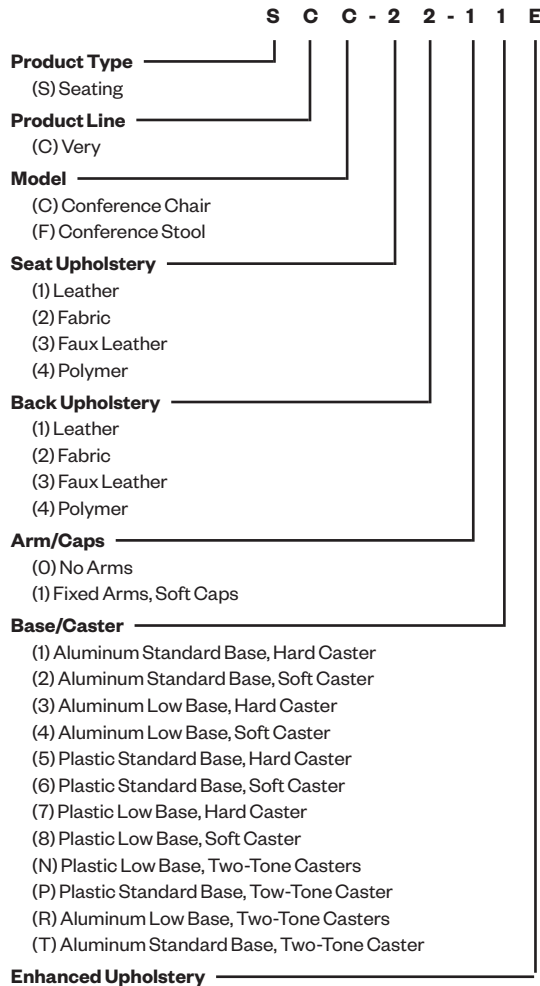

# Very

## Conference Chair — Perforated Back



SCC-44-11



SCC-44-01  
Class VY

### Features

- Back: High-strength polymer with flexing perforations and an optional upholstered foam pad.
- Seat: High-strength polymer with an optional upholstered foam pad.
- Upholstered seat features 1" (25mm) foam pad.
- Upholstered back features 0.5" (13mm) foam pad.
- Arms: Black or Fog glass-filled polypropylene hard arm caps.
- Base: Standard five-star all aluminum or all plastic base.
- 5" (127mm) height adjustment.
- Weight assisted recline mechanism.
- Casters: Hard (black), soft (black) or two-tone (fog and gray).
- Back tilts backward 14° from the upright position. Additional recline achieved in flexible back.
- Painted or optional polished aluminum.
- COM yardage / COL square footage:  
Fully Upholstered: 1.5/17  
Upholstered seat: 0.75/9.5

### Dimensions

- Height: H: 36.9" (937mm)  
\*SH: 15.5-20.5" (394-521mm)  
Low position base: \*SH: 14.4-19.4" (366-493mm)  
\*AH: 8.7" (221mm)  
Between Arms: 20.8" (528mm)
- Depth: D: 26.7" (678mm)  
\*SD: 17.5" (445mm)
- Width: W: 25" (635mm)  
\*SW: 19.2" (488mm)

\*Measurements taken with the BIFMA chair measuring device.

### To Order, Specify:

1) Product number, including:

#### 1 Seat or Seat Pad Option:

- 1 Leather
- 2 Fabric
- 3 Faux Leather
- 4 Polymer

#### 2 Back or Back Pad Option:

- 1 Leather
- 2 Fabric
- 3 Faux Leather
- 4 Polymer Base/Caster

#### 3 Option:

##### Plastic Base

- 5 Plastic Std. Base, Hard Caster
- 6 Plastic Std. Base, Soft Caster (add **\$68.64** list)
- P Plastic Std. Base, Two-Tone Casters

##### Plastic Low Position

- 7 Plastic Low Base, Hard Caster
- 8 Plastic Low Base, Soft Caster (add **\$68.64** list)
- N Plastic Low Base, Two-Tone Casters

##### Aluminum Base

- 1 Aluminum Std. Base, Hard Caster
- 2 Aluminum Std. Base, Soft Caster (add **\$68.64** list)
- T Aluminum Std. Base, Two-Tone Casters

##### Aluminum Low Position

- 3 Aluminum Low Base, Hard Caster
- 4 Aluminum Low Base, Soft Caster (add **\$68.64** list)
- R Aluminum Low Base, Two-Tone Casters

- 2) Fabric surface and color (seat).
- 3) Fabric surface and color (back).
- 4) Shell color – required for upholstered and non-upholstered.
- 5) Trim for arm caps, plastic components and base (plastic base only).
- 6) Trim color for aluminum components (aluminum base, control housing, and frame).

Polished Aluminum (PM-P)  
(add **\$312.70** list)

# Very

## Conference Chair — Perforated Back

Description	Number ①②③	Price	Fabric								Leather	
			A	B	C	D	E	F	G	H	A	B
<b>Plastic Base Without Optional Upholstered Pad</b>												
With Arms	SCC-44-1	\$1353.72	N/A	N/A	N/A	N/A	N/A	N/A	N/A	N/A	N/A	N/A
Without Arms	SCC-44-0	1228.62	N/A	N/A	N/A	N/A	N/A	N/A	N/A	N/A	N/A	N/A
<b>Plastic Base With Upholstered Seat Pad</b>												
With Arms	SCC-4-1 E	N/A	\$1562.09	\$1620.61	\$1683.16	\$1711.39	\$1737.58	\$1790.09	\$1840.49	\$1973.67	\$1832.43	\$2074.20
Without Arms	SCC-4-0 E	N/A	1436.99	1495.51	1558.06	1586.29	1612.48	1664.99	1715.39	1848.57	1707.33	1949.10
<b>Plastic Base With Upholstered Seat and Back Pads</b>												
With Arms	SCC-4-1 E	N/A	\$1708.89	\$1825.63	\$1950.73	\$2007.19	\$2059.57	\$2164.59	\$2265.39	\$2531.75	\$2249.27	\$2732.81
Without Arms	SCC-4-0 E	N/A	1583.49	1700.53	1825.63	1882.09	1934.47	2039.49	2140.29	2406.65	2124.17	2607.71
<b>Aluminum Base Without Optional Upholstered Pad</b>												
With Arms	SCC-44-1	\$1561.51	N/A	N/A	N/A	N/A	N/A	N/A	N/A	N/A	N/A	N/A
Without Arms	SCC-44-0	1436.41	N/A	N/A	N/A	N/A	N/A	N/A	N/A	N/A	N/A	N/A
<b>Aluminum Base With Upholstered Seat Pad</b>												
With Arms	SCC-4-1 E	N/A	\$1769.88	\$1828.40	\$1890.95	\$1919.18	\$1945.37	\$1997.88	\$2048.28	\$2181.46	\$2040.22	\$2281.99
Without Arms	SCC-4-0 E	N/A	1644.78	1703.30	1765.85	1794.08	1820.27	1872.78	1923.18	2056.36	1915.12	2156.89
<b>Aluminum Base With Upholstered Seat and Back Pads</b>												
With Arms	SCC-4-1 E	N/A	\$1916.38	\$2033.42	\$2158.52	\$2214.98	\$2267.36	\$2372.38	\$2473.18	\$2739.54	\$2457.06	\$2940.60
Without Arms	SCC-4-0 E	N/A	1791.28	1908.32	2033.42	2089.88	2142.26	2247.28	2348.08	2614.44	2331.96	2815.50

The following options require modification of the product number.

Stain repellent

To specify, add **P** to end of the product number (add **\$62.54** list).

**Note:** Stain repellent is available on SCC-22 and SCC-24 models only. For available fabrics, refer to [surfaces.haworth.com](https://surfaces.haworth.com).

# Very

## Conference Stool — Perforated Back



SCF-44-11



SCF-44-01  
Class VY

### Features

- Back: High-strength polymer back with flexing perforations and an optional upholstery pad.
- Seat: High-strength polymer seat with an optional upholstery pad.
- Weight assisted recline mechanism.
- Upholstered seat features 1"(25mm) foam pad.
- Upholstered back features 0.5"(13mm) foam pad.
- Arms: Black or Fog hard arm caps.
- Base: Standard five-star all aluminum or all plastic base.
- Footring: Brushed Aluminum finish.
- Adjustable footring: adjusts 4"(102mm) up and down.
- Casters: Standard with hard casters, black or two-tone.
- Optional black soft casters.
- COM yardage / COL square footage:  
Fully Upholstered: 1.5/13  
Upholstered seat: .75/7.25

### Dimensions

Height:	Depth:	Width:
H: 44.4-53.4" (1128-1356mm)	D: 26.7"(678mm) SD: 17.2"(437mm)	W: 25"(635mm) SW: 18.75"(476mm)
SH: 23-32" (584-813mm)		
AH: 8.7"(221mm)		
Between Arms: 20.8"(528mm)		

### To Order, Specify:

- Product number.
  - 1 Seat or Seat Pad Option:**
    - Leather
    - Fabric
    - Faux Leather
    - Polymer
  - 2 Back or Back Pad Option:**
    - Leather
    - Fabric
    - Faux Leather
    - Perforated Polymer
  - 3 Arm Option:**
    - No Arms
    - Fixed Arm, Hard Caps (add **\$250.21** list)
  - 4 Base or Caster Option:**

**Plastic Base**

    - Plastic Std. Base, Hard Casters
    - Plastic Std. Base, Soft Casters (add **\$68.64** list)
    - Plastic Std. Base, Two-Tone Casters

**Aluminum Base**

    - Aluminum Std. Base, Hard Casters
    - Aluminum Std. Base, Soft Casters (add **\$68.64** list)
    - Aluminum Std. Base, Two-Tone Casters
- Fabric surface and color (seat).
  - Fabric surface and color (back).
  - Shell color - required for upholstered and non-upholstered.
  - Trim for arm caps (if specified). (base if plastic is specified above).
  - Frame trim color- Aluminum components (base if aluminum and arm uprights).

Description	Number				Price	Fabric						Leather			
	1	2	3	4		A	B	C	D	E	F	G	H	A	B
<b>Plastic Base Without Optional Upholstered Pad</b>															
SCF-44-■■■					\$ 1819.74	N/A	N/A	N/A	N/A	N/A	N/A	N/A	N/A	N/A	
<b>Plastic Base With Upholstered Seat Pad</b>															
SCF-■4-■■■E					N/A	\$2028.11	\$2086.63	\$ 2149.18	\$ 2177.41	\$2203.60	\$2256.11	\$2306.51	\$2439.69	\$2298.45	\$2540.22
<b>Plastic Base With Upholstered Seat and Back Pads</b>															
SCF-■■■-■■■E					N/A	\$ 2174.61	\$ 2291.65	\$ 2416.75	\$ 2473.21	\$ 2525.59	\$2630.61	\$ 2731.41	\$ 2997.77	\$ 2715.29	\$ 3198.83
<b>Aluminum Base Without Optional Upholstered Pad</b>															
SCF-44-■■■					\$2027.53	N/A	N/A	N/A	N/A	N/A	N/A	N/A	N/A	N/A	
<b>Aluminum Base With Upholstered Seat Pad</b>															
SCF-■4-■■■E					N/A	\$ 2235.90	\$2294.42	\$2356.97	\$2385.20	\$ 2411.39	\$2463.90	\$ 2514.30	\$2647.48	\$2506.24	\$ 2748.01
<b>Aluminum Base With Upholstered Seat and Back Pads</b>															
SCF-■■■-■■■E					N/A	\$2382.40	\$2499.44	\$2624.54	\$ 2681.00	\$2733.38	\$2838.40	\$2939.20	\$3205.56	\$2923.08	\$3406.62

The following options require modification of the product number.

Stain repellent

To specify, add **P** to end of the product number (add **\$62.54** list); **Example:** SCF-22-01EP

# Very Accessories

## Ganging Connector

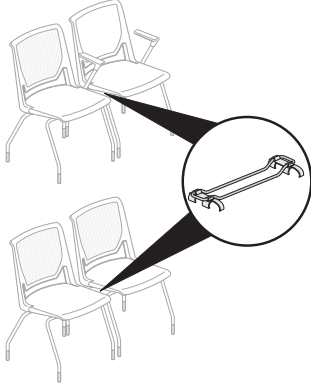

SCSG-1

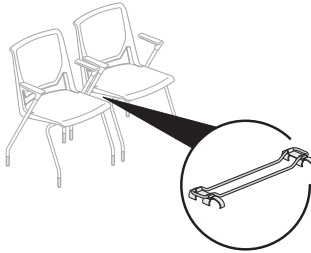

SCSG-2  
Class VY

### Features

- Field retrofittable.
- Recommended for use on chairs with glides only.
- Release for fire safety.

### To Order, Specify:

- 1) Product number.  
(No finish specification required.)

Description	Number	Price
Arm to Armless and Armless to Armless	SCSG-1	\$26.22
Arm to Arm	SCSG-2	27.51

## Stacking Carts

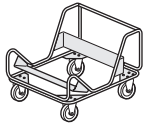

SCT-1  
Class VY

### Features

- For use with Very Wire Stacker seating.
- Cart only dimensions:  
28.5"(724mm) H x 23.88"(607mm) D x 20.25"(514mm) W

### To Order, Specify:

- 1) Product number.  
(No color specification required.)

Description	Number	Price
Wire Stacking Cart	SCT-1	\$794.91

## Stacking Carts

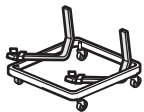

SCT-3  
SCT-4  
Class VY

### Features

- Permits stacking upholstered chairs 6-high and non-upholstered 8-high with glides and casters.
- Standard in black finish color only.
- **Cart Only Dimensions:**
  - SCT-3**  
17.3"(439mm)H x 27"(686mm)D x 25.5"(648mm)W (wt: 10.09kg)
  - SCT-4**  
17.6"(447mm)H x 30.4"(772mm)D x 25.5"(648mm)W (wt: 10.09kg)
- **Cart and Chair Maximum Dimensions:**
  - SCT-3**  
69"(1753mm)H x 46"(1168mm)D x 24"(610mm)W
  - SCT-4**  
57"(1448mm)H x 44"(1118mm)D x 24"(610mm)W
- Not for use with Side Stools.

### To Order, Specify:

- 1) Product number.  
(No color specification required.)

Description	Number	Price
Side/Seminar Chairs with Arms	SCT-3	\$665.78
Side/Seminar Chairs without Arms	SCT-4	665.78

# Soji

## At-A-Glance

---

<b>Designer</b>	Haworth Design Studio
-----------------	-----------------------

---

<b>Soji</b>	Soji is a highly-adjustable task chair with more ergonomic options than most task seating in its class—without sacrificing comfort or design.
-------------	---

---

<b>Awards/ Achievements</b>	Soji XL- Nightingale Silver Award for Clinician Support Soji XL - Nightingale Sustainability award
---------------------------------	---

---

<b>Environmental Factors</b>	Refer to the Product Environmental Data sheet (PED) for recycled content and certifications. Soji is part of the Haworth Take Back Program. Manufactured in a zero landfill, ISO 14001 certified facility in Mississippi, USA.
----------------------------------	--

---

<b>Finishes and Fabrics</b>	A complete listing of finishes and fabrics for Soji task chairs is available in the back of the price list.
---------------------------------	---

---

<b>COM &amp; COL General Information</b>	<p>To order a COM fabric (Customer's Own Material) contact the Haworth Inquiry Center (1.800.462.8562), your local Haworth dealer, or go to <a href="http://Surfaces.haworth.com">Surfaces.haworth.com</a> to find out if the COM you have selected has already been tested and approved. The surface collection site also has information on the Haworth alliance program with Carnegie, Luna Textiles, and Maharam as well as our industry-leading Pre-Approved COM program.</p> <p>COM fabrics are placed into Grades based on the cost per linear yard. If a fabric's cost exceeds the range of our highest Grade it will be noted as Non-Graded. The product will be priced at Grade A; the COM fabric costs will appear as a separate line item. The fabric charge will be Haworth's purchase cost plus a 4% administrative fee (based on the cost of the fabric). Yardage calculations will include any applicable fabric repeat.</p> <p>COM Leather products will be priced at a leather Grade A; COL costs will appear as a separate line item. The leather costs will be Haworth's purchase cost plus a 4% administrative fee (based on the cost of the leather).</p>
--	---

---

<b>Stain Repellent</b>	Stain Repellent or Stain Repellent with Moisture Barrier available on fabric surfaces only. Stain Repellent only: To specify add " <b>P</b> " to the end of the product number. Example: SJT-20-711A5 <b>P</b> Stain Repellent with Moisture Barrier: To specify add " <b>D</b> " to the end of the product number. Example: SJT-20-711A5 <b>AD</b>
------------------------	---

---

<b>Shipping Weights/Cube (Including packaging)</b>	<ul style="list-style-type: none"><li>• Assembled<ul style="list-style-type: none"><li>-With arms - 46 lbs. / 16.5 cubic feet</li><li>-Armless - 41.4 lbs. / 16.5 cubic feet</li></ul></li><li>• Knocked Down<ul style="list-style-type: none"><li>-With arms - 42 lbs. / 12.2 cubic feet</li><li>-Armless - 37.4 lbs. / 12.2 cubic feet</li></ul></li></ul>
--	--

---

<b>Specifications</b>	Soji - Task chairs and stools designed for use by individuals up to 350 lbs. Soji XL - Task chairs designed for use by individuals up to 600 lbs.
-----------------------	--

# Soji

## At-A-Glance

### Catalog Logic

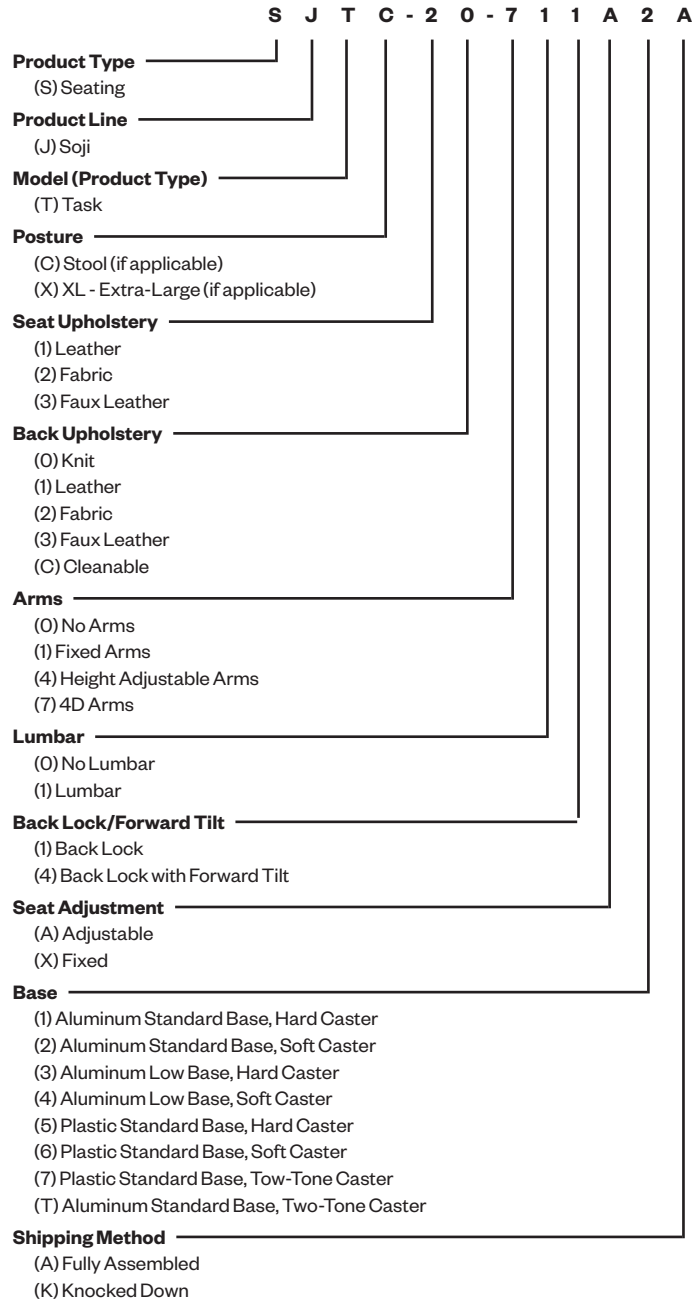

# Soji

## At-A-Glance

### Features

Pneumatic seat height adjustment:

- Standard model adjusts 16.4"-21"
- Low position model adjusts 14.75"-17.5"
- Stool adjusts 22"-29.5"

Synchronous tilt mechanism provides 23° of back recline.

Standard tilt mechanism control regulates the amount of resistance of the back.

Standard five-star base in plastic or optional aluminum. Optional low position base in aluminum.

Hard casters available for carpet flooring and soft casters for hard flooring.

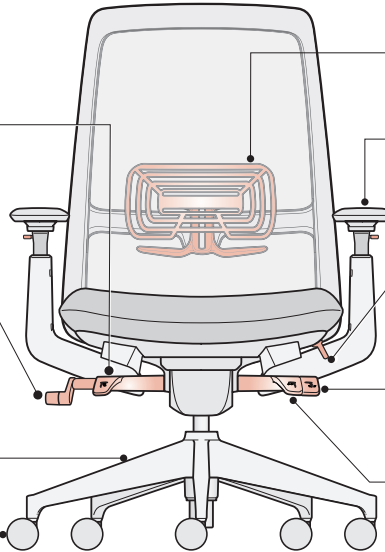

Front View

Optional height adjustable lumbar has 3.5" of height adjustment.

Arms available fixed, height adjustable and 4D; armless.

Optional forward tilt allows seat pan to move downward 5° from the initial position. Forward tilt not available on stool.

Single position back lock to lock back of chair in the upright position.

Seat standard fixed or optional adjustable (2.5" seat depth range).

### Aesthetic Options

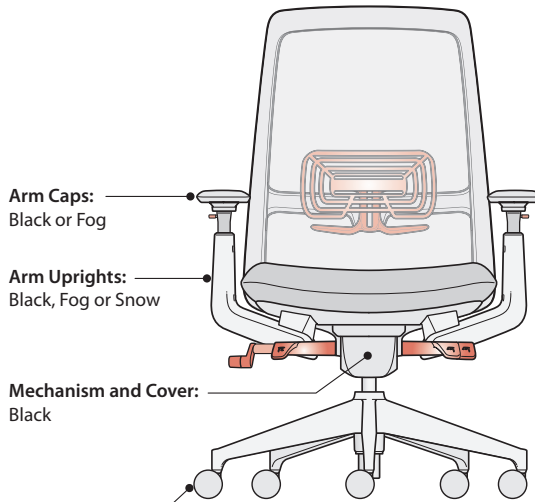

Front View

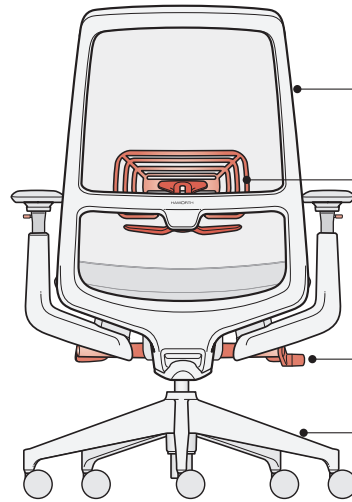

Back View

**Arm Caps:**  
Black or Fog

**Arm Uprights:**  
Black, Fog or Snow

**Mechanism and Cover:**  
Black

**Casters:**  
• Hard: Black or Two-Tone Grey  
• Soft: Black

**Frame:**  
Black, Fog or Snow

**Lumbar:**  
Black or Fog

**Controls:**  
Black

**Base:**  
• Plastic: Black or Fog  
• Aluminum: Black, Metallic Silver or Polished Aluminum

# Soji

## At-A-Glance — Standard Mobility and Adjustability

### Seat Height Adjustment

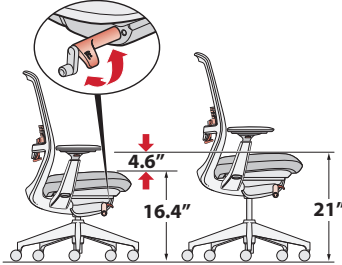

#### Features

- Pneumatic seat height adjustment.
- Seat height adjusts 4.6"(117mm) from 16.4" to 21.0"(417mm-533mm) on standard models. Low-position adjusts from 14.75" to 17.5"(375mm-445mm). Stool adjusts from 22" to 29.5"(559mm-749mm).

#### Benefits

- Ensures the comfort of the lower limbs by avoiding pressure on the underside of the thigh caused by a seat pan that is too high, or decreased thigh-to-torso angle if the seat is too low.
- Seat height adjustment is important in setting the proper hand position and allowing for proper sitting eye height as well.

### Seat Depth Adjustment

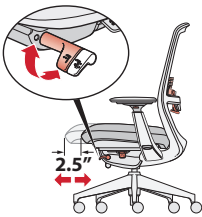

#### Feature

- Optional seat depth has 2.5"(64mm) seat depth range. Fixed seat also available.

#### Benefit

- Supports the thighs, allows users to rest against the seat back for back support, and avoids pressure on the back of the knees of small to tall users.

### Synchronous Tilt Mechanism

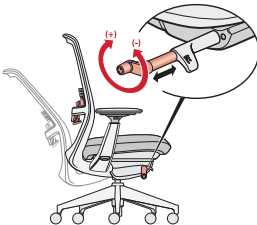

#### Features

- Back reclines 23° from the upright position.
- 2:1 recline ratio.

#### Benefits

- Comfortable relaxed posture.
- Recline allows for the opening of the user's chest cavity providing good airflow to promote alertness.
- User's feet remain flat on the floor.

### Tilt Tension Control

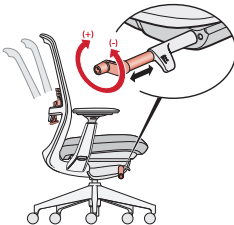

#### Feature

- Regulates the amount of resistance felt when leaning back in the chair and the effort required to recline the chair backwards.

#### Benefit

- Personalized support to accommodate users of different body types and different work styles.

### Forward Tilt

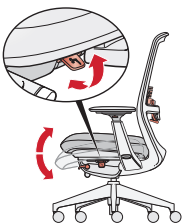

#### Features

- Optional forward tilt allows seat pan to move 5° downward from the initial position.
- Forward tilt not available on task stool.

#### Benefit

- Allows user the opportunity to vary their posture throughout the day.

# Soji

## At-A-Glance — Standard Mobility and Adjustability

### Back Lock



**Feature**

- Single position back lock.

**Benefit**

- Allows users to lock the back of the chair in the upright position for tasking applications.

### Lumbar Support

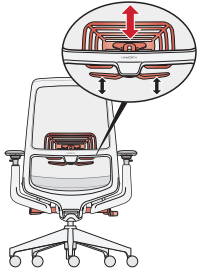

**Features**

- Optional height adjustable lumbar.
- Range of 3.5"(89mm) of height adjustment.
- Available in Black or Fog. Lumbar will be black if Carbon knit is ordered or plastic trim color is black. Lumbar will be Fog if plastic trim is specified as Fog or Snow and knit is not Carbon.

**Benefits**

- Provides additional support in the lower back.
- Lumbar adjustment maintains the natural curvature of the spine at the lower back and allows the user to position the support to where it is most comfortable.

### 4D Arm

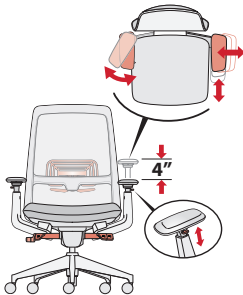

**Features**

- Optional 4D arm adjusts in 4 ways:
  - Height adjustment 4"(102mm)
  - Side-to-side arm cap adjustment range: 3"(76mm) [ each arm cap]
  - Front-to-back adjustment range: 3.5"(89mm)
  - Pivoting 20° in and 20° out

**Benefits**

- Arms support the muscular system of user's neck and shoulders; proper arm support provides back relief.
- Arms can be an aid in standing or sitting down.
- Height adjustment accommodates for users with varying elbow rest heights so that users avoid lifting their shoulders or leaning sideways to get arm support.
- Front-to-back adjustment adjusts the armrest length, which is important because it allows users to get close to the worksurface while maintaining the effective use of the backrest.
- Side-to-side adjustment ensures a comfortable resting position for the arms with proper support of the forearm while allowing for easy entry/exit of the chair.
- Pivoting provides proper support of the forearm when performing tasks involving keying and mousing.

### Height Adjustable Arm

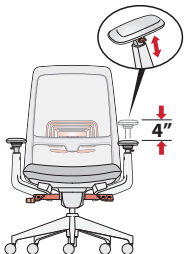

**Feature**

- Optional height adjustable arms adjust 4"(102mm) vertically.

**Benefit**

- Height adjustment accommodates users with varying elbow rest heights so that users avoid lifting their shoulders or leaning sideways to get arm support.

# Soji

## At-A-Glance — Standard Mobility and Adjustability

---

### Base

#### Standard Plastic Base

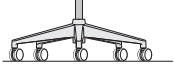
**Colors**

Fog, Black

**Casters**

Hard: Black or Two-Tone Grey

Soft: Black

#### Aluminum Base

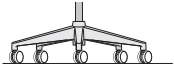
**Colors**

Painted Black or Metallic Silver or Polished aluminum

**Casters**

Hard: Black or Two-Tone Grey

Soft: Black

#### Low Position Base (Aluminum only)

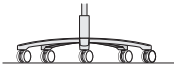
**Colors**

Painted Black or Metallic Silver

**Casters**

Hard: Black

Soft: Black

### Leather Upholstery

**Feature**

- Leather will have double stitched seams vertically in the center of the back and seat cushion as well as on the edges of the seat cushion.



### Cleanable Upholstery

**Features**

- Seamless Faux Leather inner back.
- Outer back will be backed with Faux Leather for full cleanability.
  - Black trim will default to Wellington Black
  - Fog or Snow trim will default to Wellington Steel
- Inner back for cleanable upholstery must also be specified in Faux Leather. Refer to [surfaces.haworth.com](http://surfaces.haworth.com) for available options.
- To specify, change the back upholstery option to "C". Example: SJT-3C-701X5A



# Soji

## Task Chair



SJT-20-011A



SJT-20-111A



SJT-20-401X



SJT-20-711A  
Class ST

### Features

- Back: Knit or upholstered.
- Seat: Standard upholstered foam. Available as a fixed seat or with seat depth adjustment 2.5"(64mm) range.
- Base options:
  - Standard plastic five-star base in Black or Fog. Hard casters in black or two-tone or soft casters in black.
  - Aluminum five-star base painted or polished aluminum. Painted in Black or Metallic Silver. Hard casters in black or two-tone or soft casters in black.
  - Aluminum low-position base available with hard or soft casters in black only.
- Arm options:
  - No arms
  - Fixed
  - Height Adjustable with 4"(102mm) adjustment range.
  - 4D with soft arm caps. Height adjustment 4"(102mm), side-to-side arm cap adjustment of 3"(76mm)[1.5"(38mm) each arm cap] Front-to-back adjustment range of 3.5"(89mm) and pivot in 20° and out 20°.
- Height adjustment: Pneumatic or low-position pneumatic.
- Mechanism: Synchronized tilt; standard tilt tension adjustment.
- Back Lock: Standard single position upright back lock.
- Forward Tilt (Optional): 5° downward from initial position. Only available on chairs with seat depth adjustment.
- Lumbar: Optional lumbar support with 3.5"(89mm) adjustment.
- COM yardage/COL square footage:
  - Seat: 0.75/7
  - Back: 1.25/12

### Specification Tips

- Ships standard assembled. Optional knocked down shipment comes in three pieces; assembly does not require tools.
- Lumbar available in Black or Fog only. Color defaults based on chair attributes.
  - Black; plastic trim is black or Carbon Knit is ordered.
  - Fog; plastic trim is Fog or Snow and knit is not Carbon.
- Reference color chart for applied backing material for upholstered or cleanable upholstery back.

Upcharge for mixed grade surfaces, refer to the electronic design and specification tools.

### Dimensions

Height:	Depth:	Width:
H: 39-44" (991-1118mm)	D: 27"(686mm) *SD: 16.25-18.75" (413-476mm)	W: 28"(711mm) *SW: 20"(508mm)
*SH: 16.4-21" (417-533mm)		
*AH: 7.4-11.4" (188-290mm)		
Low position SH: 14.75-17.5"(375-445mm)		

\*Measurements taken with the BIFMA chair measuring device.

Plastic Trim Color	Lumbar	Arm Caps	Backing Material for Upholstered Back	Backing Material for Cleanable Upholstered Back
TR-F Black	TR-F Black	TR-F Black	Tellure, Black 3A-18	Wellington, Black XJ-BL
TR-7 Fog	TR-7 Fog*	TR-7 Fog	Tellure, Goose 3A-54	Wellington, Steel XJ-SL
TR-UFM Snow	TR-7 Fog*	TR-7 Fog	Tellure, Goose 3A-54	Wellington, Steel XJ-SL

\*If knit is Carbon, lumbar will be Black.

### To Order, Specify:

1) Product number, including:

#### 1 Seat Upholstery:

- 1 Leather
- 2 Fabric
- 3 Faux Leather

#### 2 Back Upholstery:

- 0 Knit
- 1 Leather
- 2 Fabric
- 3 Faux Leather

#### 3 Base/Caster Option:

##### Plastic Base

- 5 Plastic Base, Hard Casters
- 6 Plastic Base, Soft Casters (add **\$61.30** list)
- P Plastic Base, Hard Two-Tone Casters (add **\$26.75** list)

##### Aluminum Base - Standard

- 1 Aluminum Base, Hard Casters (add **\$94.26** list)
- 2 Aluminum Base, Soft Casters (add **\$155.56** list)
- T Aluminum Base, Two-Tone Casters (add **\$121.01** list)

##### Low Base - Aluminum

- 3 Aluminum Low Base, Hard Casters (add **\$94.26** list)
- 4 Aluminum Low Base, Soft Casters (add **\$155.56** list)

2) Seat upholstery.

3) Back upholstery.

4) Plastic trim color.

(frame and arm uprights).

TR-F Black

TR-7 Fog (add **\$98.58** list)

TR-UFM Snow (add **\$159.24** list)

5) Base color.

Plastic Base

TR-F Black

TR-7 Fog

Aluminum Base

TR-F Black

TR-LE Metallic Silver

PM-P Polished Aluminum (add **\$144.51** list)

# Soji Task Chair

Plastic Base*		Number		Fabric								Leather		
Adjustments	Arms	①	②	A	B	C	D	E	F	G	H	A	B	
<b>No Lumbar Adjustment - Knit Back</b>														
Fixed Seat	No arm	SJT-	0-001X	A	\$ 888.68	\$ 936.42	\$ 987.60	\$ 1011.53	\$ 1031.97	\$ 1076.34	\$ 1117.27	\$ 1226.45	\$ 1323.68	\$ 1536.92
	Fixed	SJT-	0-101X	A	982.24	1029.98	1081.16	1105.09	1125.53	1169.90	1210.83	1320.01	1417.24	1630.48
	Height Adjustable	SJT-	0-401X	A	1053.85	1101.59	1152.77	1176.70	1197.14	1241.51	1282.44	1391.62	1488.85	1702.09
Seat Depth Adjustment	4D	SJT-	0-701X	A	1085.15	1132.89	1184.07	1208.00	1228.44	1272.81	1313.74	1422.92	1520.15	1733.39
	No arm	SJT-	0-001A	A	920.55	968.29	1019.47	1043.40	1063.84	1108.21	1149.14	1258.32	1355.55	1568.79
	Fixed	SJT-	0-101A	A	1014.11	1061.85	1113.03	1136.96	1157.40	1201.77	1242.70	1351.88	1449.11	1662.35
Forward Tilt	Height Adjustable	SJT-	0-401A	A	1085.72	1133.46	1184.64	1208.57	1229.01	1273.38	1314.31	1423.49	1520.72	1733.96
	4D	SJT-	0-701A	A	1117.02	1164.76	1215.94	1239.87	1260.31	1304.68	1345.61	1454.79	1552.02	1765.26
	No arm	SJT-	0-004A	A	982.18	1029.92	1081.10	1105.03	1125.47	1169.84	1210.77	1319.95	1417.18	1630.42
Seat Depth Adjustment	Fixed	SJT-	0-104A	A	1075.74	1123.48	1174.66	1198.59	1219.03	1263.40	1304.33	1413.51	1510.74	1723.98
	Height Adjustable	SJT-	0-404A	A	1147.35	1195.09	1246.27	1270.20	1290.64	1335.01	1375.94	1485.12	1582.35	1795.59
	4D	SJT-	0-704A	A	1178.65	1226.39	1277.57	1301.50	1321.94	1366.31	1407.24	1516.42	1613.65	1826.89
<b>No Lumbar Adjustment - Upholstered Back</b>														
Fixed Seat	No arm	SJT-	-001X	A	\$ 1047.66	\$ 1143.14	\$ 1245.50	\$ 1293.36	\$ 1334.24	\$ 1422.98	\$ 1504.84	\$ 1723.20	\$ 1917.66	\$ 2344.14
	Fixed	SJT-	-101X	A	1141.22	1236.70	1339.06	1386.92	1427.80	1516.54	1598.40	1816.76	2011.22	2437.70
	Height Adjustable	SJT-	-401X	A	1212.83	1308.31	1410.67	1458.53	1499.41	1588.15	1670.01	1888.37	2082.83	2509.31
Seat Depth Adjustment	4D	SJT-	-701X	A	1244.13	1339.61	1441.97	1489.83	1530.71	1619.45	1701.31	1919.67	2114.13	2540.61
	No arm	SJT-	-001A	A	1079.53	1175.01	1277.37	1325.23	1366.11	1454.85	1536.71	1755.07	1949.53	2376.01
	Fixed	SJT-	-101A	A	1173.09	1268.57	1370.93	1418.79	1459.67	1548.41	1630.27	1848.63	2043.09	2469.57
Forward Tilt	Height Adjustable	SJT-	-401A	A	1244.70	1340.18	1442.54	1490.40	1531.28	1620.02	1701.88	1920.24	2114.70	2541.18
	4D	SJT-	-701A	A	1276.00	1371.48	1473.84	1521.70	1562.58	1651.32	1733.18	1951.54	2146.00	2572.48
	No arm	SJT-	-004A	A	1141.16	1236.64	1339.00	1386.86	1427.74	1516.48	1598.34	1816.70	2011.16	2437.64
Seat Depth Adjustment	Fixed	SJT-	-104A	A	1234.72	1330.20	1432.56	1480.42	1521.30	1610.04	1691.90	1910.26	2104.72	2531.20
	Height Adjustable	SJT-	-404A	A	1306.33	1401.81	1504.17	1552.03	1592.91	1681.65	1763.51	1981.87	2176.33	2602.81
	4D	SJT-	-704A	A	1337.63	1433.11	1535.47	1583.33	1624.21	1712.95	1794.81	2013.17	2207.63	2634.11
<b>Lumbar Adjustment - Knit Back</b>														
Fixed Seat	No arm	SJT-	0-011X	A	\$ 961.47	\$ 1009.21	\$ 1060.39	\$ 1084.32	\$ 1104.76	\$ 1149.13	\$ 1190.06	\$ 1299.24	\$ 1396.47	\$ 1609.71
	Fixed	SJT-	0-111X	A	1055.03	1102.77	1153.95	1177.88	1198.32	1242.69	1283.62	1392.80	1490.03	1703.27
	Height Adjustable	SJT-	0-411X	A	1126.64	1174.38	1225.56	1249.49	1269.93	1314.30	1355.23	1464.41	1561.64	1774.88
Seat Depth Adjustment	4D	SJT-	0-711X	A	1157.94	1205.68	1256.86	1280.79	1301.23	1345.60	1386.53	1495.71	1592.94	1806.18
	No arm	SJT-	0-011A	A	993.34	1041.08	1092.26	1116.19	1136.63	1181.00	1221.93	1331.11	1428.34	1641.58
	Fixed	SJT-	0-111A	A	1086.90	1134.64	1185.82	1209.75	1230.19	1274.56	1315.49	1424.67	1521.90	1735.14
Forward Tilt	Height Adjustable	SJT-	0-411A	A	1158.51	1206.25	1257.43	1281.36	1301.80	1346.17	1387.10	1496.28	1593.51	1806.75
	4D	SJT-	0-711A	A	1189.81	1237.55	1288.73	1312.66	1333.10	1377.47	1418.40	1527.58	1624.81	1838.05
	No arm	SJT-	0-014A	A	1054.97	1102.71	1153.89	1177.82	1198.26	1242.63	1283.56	1392.74	1489.97	1703.21
Seat Depth Adjustment	Fixed	SJT-	0-114A	A	1148.53	1196.27	1247.45	1271.38	1291.82	1336.19	1377.12	1486.30	1583.53	1796.77
	Height Adjustable	SJT-	0-414A	A	1220.14	1267.88	1319.06	1342.99	1363.43	1407.80	1448.73	1557.91	1655.14	1868.38
	4D	SJT-	0-714A	A	1251.44	1299.18	1350.36	1374.29	1394.73	1439.10	1480.03	1589.21	1686.44	1899.68
<b>Lumbar Adjustment - Upholstered Back</b>														
Fixed Seat	No arm	SJT-	-011X	A	\$ 1120.45	\$ 1215.93	\$ 1318.29	\$ 1366.15	\$ 1407.03	\$ 1495.77	\$ 1577.63	\$ 1795.99	\$ 1990.45	\$ 2416.93
	Fixed	SJT-	-111X	A	1214.01	1309.49	1411.85	1459.71	1500.59	1589.33	1671.19	1889.55	2084.01	2510.49
	Height Adjustable	SJT-	-411X	A	1285.62	1381.10	1483.46	1531.32	1572.20	1660.94	1742.80	1961.16	2155.62	2582.10
Seat Depth Adjustment	4D	SJT-	-711X	A	1316.92	1412.40	1514.76	1562.62	1603.50	1692.24	1774.10	1992.46	2186.92	2613.40
	No arm	SJT-	-011A	A	1152.32	1247.80	1350.16	1398.02	1438.90	1527.64	1609.50	1827.86	2022.32	2448.80
	Fixed	SJT-	-111A	A	1245.88	1341.36	1443.72	1491.58	1532.46	1621.20	1703.06	1921.42	2115.88	2542.36
Forward Tilt	Height Adjustable	SJT-	-411A	A	1317.49	1412.97	1515.33	1563.19	1604.07	1692.81	1774.67	1993.03	2187.49	2613.97
	4D	SJT-	-711A	A	1348.79	1444.27	1546.63	1594.49	1635.37	1724.11	1805.97	2024.33	2218.79	2645.27
	No arm	SJT-	-014A	A	1213.95	1309.43	1411.79	1459.65	1500.53	1589.27	1671.13	1889.49	2083.95	2510.43
Seat Depth Adjustment	Fixed	SJT-	-114A	A	1307.51	1402.99	1505.35	1553.21	1594.09	1682.83	1764.69	1983.05	2177.51	2603.99
	Height Adjustable	SJT-	-414A	A	1379.12	1474.60	1576.96	1624.82	1665.70	1754.44	1836.30	2054.66	2249.12	2675.60
	4D	SJT-	-714A	A	1410.42	1505.90	1608.26	1656.12	1697.00	1785.74	1867.60	2085.96	2280.42	2706.90

\*Pricing based on plastic base with hard casters.

The following options require modification of the product number.

- Knocked Down Shipment
- Stain Repellent
- Fully Cleanable Back

To specify, change the 11th digit from an **A** to **K** (deduct **\$50.04** list); **Example:** SJT-20-001X**K**  
 To specify, add **P** to the end of the product number (add **\$53.08** list); **Example:** SJT-20-001X**1AP**  
 To specify, change the 5th digit to **C** (add **\$41.68** list to upholstered back list price); **Example:** SJT-3**C**-001X**A**  
**Note:** Inner back must be Faux Leather to have a fully cleanable back.

# Soji XL

## Task Chair



SJTX-101A  
Class ST

### Features

- Back: Knit or upholstered.
- Adjustable Seat: Standard upholstered foam covered in leather, fabric or faux leather.
- Base: Plastic five-star base with hard casters in black or two-tone grey, or soft casters in black.
- Arms options:
  - No arms
  - Fixed arms
  - Height adjustable; 4"(102mm) height adjustment range.
  - 4D; 4"(102mm) height adjustment, 4"(102mm) side-to-side range, 2"(51mm) front-to-back range and pivots 20° in and 20° out.
- Lumbar: Optional lumbar support has 3.5"(89mm) adjustment.
- Mechanism: Pneumatic
- Back stop in upright position.
- COM yardage/COL square footage:  
Seat: 1.0/9

### Specification Tips

- Ships fully assembled.
- Lumbar color defaults based on chair attributes and is available in Black or Fog only.
  - Black will be received if Carbon knit is ordered or plastic trim color is Black.
  - Fog will be received if Fog or Snow plastic trim is ordered and knit is not Carbon.
- Reference color chart for applied backing material for upholstered or cleanable upholstered back.

### Dimensions

Height:	Depth:	Width:
H: 40.3-45" (1024-1143mm)	D: 27"(686mm) *SD: 16.9-18.5" (429-470mm)	W: 28.75"(730mm) *SW: 24.5"(622mm)
*SH: 17-21.7" (432-551mm)		
*AH: 7.8-11.7" (178-297mm)		

\*Measurements taken with the BIFMA chair measuring device.

Plastic Trim Color	Lumbar	Arm Caps	Backing Material for Upholstered Back	Backing Material for Cleanable Upholstered Back
TR-F Black	TR-F Black	TR-F Black	Tellure, Black 3A-18	Wellington, Black XJ-BL
TR-7 Fog	TR-7 Fog*	TR-7 Fog	Tellure, Goose 3A-54	Wellington, Steel XJ-SL
TR-UFM Snow	TR-7 Fog*	TR-7 Fog	Tellure, Goose 3A-54	Wellington, Steel XJ-SL

\*If knit is Carbon, lumbar will be Black.

### To Order, Specify:

1) Product number, including:

#### 1 Seat Material:

- 1 Leather
- 2 Fabric
- 3 Faux Leather

#### 2 Back Material:

- 0 Knit
- 1 Leather
- 2 Fabric
- 3 Faux Leather

#### 3 Caster Option:

- 5 Hard - Black
- 6 Soft - Black (add **\$61.30** list)
- 7 Hard - Two-Tone Grey

2) Seat upholstery.

3) Back upholstery.

4) Trim color (frame and arm uprights).  
TR-F Black  
TR-7 Fog (add **\$98.58** list)  
TR-UFM Snow (add **\$159.24** list)

5) Base color.

TR-F Black  
TR-7 Fog

# Soji XL

## Task Chair

Description	Number			Fabric								Leather	
	①	②	③	A	B	C	D	E	F	G	H	A	B
<b>No Lumbar Adjustment - Knit Back</b>													
No Arm	SJTX-	O-001A	A	\$2429.66	\$2477.40	\$2528.58	\$2552.51	\$2572.95	\$2617.32	\$2658.25	\$2767.43	\$2864.66	\$3077.90
Fixed Arm	SJTX-	O-101A	A	2523.22	2570.96	2622.14	2646.07	2666.51	2710.88	2751.81	2860.99	2958.22	3171.46
Height Adjustable	SJTX-	O-401A	A	2594.83	2642.57	2693.75	2717.68	2738.12	2782.49	2823.42	2932.60	3029.83	3243.07
4D	SJTX-	O-701A	A	2626.13	2673.87	2725.05	2748.98	2769.42	2813.79	2854.72	2963.90	3061.13	3274.37
<b>No Lumbar Adjustment - Upholstered Back</b>													
No Arm	SJTX-	-001A	A	\$2588.64	\$2684.12	\$2786.48	\$2834.34	\$2875.22	\$2963.96	\$3045.82	\$3264.18	\$3458.64	\$3885.12
Fixed Arm	SJTX-	-101A	A	2682.20	2777.68	2880.04	2927.90	2968.78	3057.52	3139.38	3357.74	3552.20	3978.68
Height Adjustable	SJTX-	-401A	A	2753.81	2849.29	2951.65	2999.51	3040.39	3129.13	3210.99	3429.35	3623.81	4050.29
4D	SJTX-	-701A	A	2785.11	2880.59	2982.95	3030.81	3071.69	3160.43	3242.29	3460.65	3655.11	4081.59
<b>Lumbar Adjustment - Knit Back</b>													
No Arm	SJTX-	O-011A	A	\$2502.45	\$2550.19	\$2601.37	\$2625.30	\$2645.74	\$2690.11	\$2731.04	\$2840.22	\$2937.45	\$3150.69
Fixed Arm	SJTX-	O-111A	A	2596.01	2643.75	2694.93	2718.86	2739.30	2783.67	2824.60	2933.78	3031.01	3244.25
Height Adjustable	SJTX-	O-411A	A	2667.62	2715.36	2766.54	2790.47	2810.91	2855.28	2896.21	3005.39	3102.62	3315.86
4D	SJTX-	O-711A	A	2698.92	2746.66	2797.84	2821.77	2842.21	2886.58	2927.51	3036.69	3133.92	3347.16
<b>Lumbar Adjustment - Upholstered Back</b>													
No Arm	SJTX-	-011A	A	\$2661.43	\$2756.91	\$2859.27	\$2907.13	\$2948.01	\$3036.75	\$3118.61	\$3336.97	\$3531.43	\$3957.91
Fixed Arm	SJTX-	-111A	A	2754.99	2850.47	2952.83	3000.69	3041.57	3130.31	3212.17	3430.53	3624.99	4051.47
Height Adjustable	SJTX-	-411A	A	2826.60	2922.08	3024.44	3072.30	3113.18	3201.92	3283.78	3502.14	3696.60	4123.08
4D	SJTX-	-711A	A	2857.90	2953.38	3055.74	3103.60	3144.48	3233.22	3315.08	3533.44	3727.90	4154.38

The following options require modification of the product number.

Stain Repellent (fabric surfaces only)  
Fully Cleanable Back

To specify, add **P** to the end of the product number (add **\$53.08** list); **Example:** SJTX-22-401A5**AP**  
To specify, change the sixth digit to **C** (add **\$41.68** list to upholstered back list price);  
**Example:** SJTX-2**C**-401A5A

**Note:** Inner back must be Faux Leather to have a fully cleanable back.

# Soji

## Task Stool



SJTC-001X  
SJTC-001A



SJTC-101X  
SJTC-101A



SJTC-401X  
SJTC-401A



SJTC-701X  
SJTC-701A  
Class ST

### Features

- Back: Knit or upholstered.
- Seat: Standard upholstered foam. Available as a fixed seat or with seat depth adjustment 2.5"(64mm) range.
- Base options:
  - Standard plastic five-star base in Black or Fog. Hard casters in black or two-tone or soft casters in black.
  - Aluminum five-star base painted or polished aluminum. Painted in Black, or Metallic Silver. Hard casters in black or two-tone or soft casters in black.
- Arm options:
  - No arms
  - Fixed
  - Height Adjustable with 4"(102mm) adjustment range.
  - 4D with soft arm caps. Height adjustment 4"(102mm), side-to-side arm cap adjustment of 3"(76mm)[1.5"(38mm) each arm cap] Front-to-back adjustment range of 3.5"(89mm) and pivot in 20° and out 20°.
- Height adjustment: Pneumatic.
- Mechanism: Synchronized tilt; standard tilt tension adjustment.
- Back Lock: Single position upright back lock.
- Lumbar: Optional lumbar support with 3.5"(89mm) adjustment.
- COM yardage/COL square footage:
  - Seat: 0.75/7
  - Back: 1.25/12

### Specification Tips

- Ships standard assembled.
- Lumbar available in Black or Fog only. Color defaults based on chair attributes.
  - Black; plastic trim is black or Carbon Knit is ordered.
  - Fog; plastic trim is Fog or Snow and knit is not Carbon.
- Reference color chart for applied backing material for upholstered or cleanable upholstery back.

Upcharge for mixed grade surfaces, refer to the electronic design and specification tools.

### Dimensions

Height:	Depth:	Width:
H: 44.6-52.5" (1133-1334mm)	D: 27"(686mm) *SD: 16.25-18.75" (413-476mm)	W: 28"(711mm) *SW: 20"(508mm)
*SH: 22-29.5" (559-749mm)		
*AH: 7.4-11.4" (188-290mm)		

\*Measurements taken with the BIFMA chair measuring device.

Plastic Trim Color	Lumbar	Arm Caps	Backing Material for Upholstered Back	Backing Material for Cleanable Upholstered Back
TR-F Black	TR-F Black	TR-F Black	Tellure, Black 3A-18	Wellington, Black XJ-BL
TR-7 Fog	TR-7 Fog*	TR-7 Fog	Tellure, Goose 3A-54	Wellington, Steel XJ-SL
TR-UFM Snow	TR-7 Fog*	TR-7 Fog	Tellure, Goose 3A-54	Wellington, Steel XJ-SL

\*If knit is Carbon, lumbar will be Black.

### To Order, Specify:

1) Product number, including:

#### 1 Seat Upholstery:

- 1 Leather
- 2 Fabric
- 3 Faux Leather

#### 2 Back Upholstery:

- 0 Knit
- 1 Leather
- 2 Fabric
- 3 Faux Leather

#### 3 Base/Caster Option:

##### Plastic Base

- 5 Plastic Base, Hard Casters
- 6 Plastic Base, Soft Casters (add **\$61.30** list)
- 7 Plastic Base, Hard Two-Tone Casters

##### Aluminum Base - Standard

- 1 Aluminum Base, Hard Casters (add **\$94.26** list)
- 2 Aluminum Base, Soft Casters (add **\$155.56** list)
- T Aluminum Base, Two-Tone Casters (add **\$121.01** list)

2) Seat upholstery.

3) Back upholstery.

4) Plastic trim color.

(frame and arm uprights).

TR-F Black

TR-7 Fog (add **\$98.58** list)

TR-UFM Snow (add **\$159.24** list)

5) Base color:

Plastic Base

TR-F Black

TR-7 Fog

Aluminum Base

TR-F Black

TR-LE Metallic Silver

PM-P Polished Aluminum

(add **\$144.51** list)

# Soji

## Task Stool

Plastic Base* Adjustments	Arms	Number		Fabric							Leather			
		①	②	A	B	C	D	E	F	G	H	A	B	
<b>No Lumbar Adjustment - Knit Back</b>														
Fixed Seat	No arm	SJTC-	0-001X	A	\$1479.27	\$1527.01	\$1578.19	\$1602.12	\$1622.56	\$1666.93	\$1707.86	\$1817.04	\$1914.27	\$2127.51
	Fixed	SJTC-	0-101X	A	1572.83	1620.57	1671.75	1695.68	1716.12	1760.49	1801.42	1910.60	2007.83	2221.07
	Height Adjustable	SJTC-	0-401X	A	1644.44	1692.18	1743.36	1767.29	1787.73	1832.10	1873.03	1982.21	2079.44	2292.68
	4D	SJTC-	0-701X	A	1675.74	1723.48	1774.66	1798.59	1819.03	1863.40	1904.33	2013.51	2110.74	2323.98
Seat Depth Adjustment	No arm	SJTC-	0-001A	A	1511.14	1558.88	1610.06	1633.99	1654.43	1698.80	1739.73	1848.91	1946.14	2159.38
	Fixed	SJTC-	0-101A	A	1604.70	1652.44	1703.62	1727.55	1747.99	1792.36	1833.29	1942.47	2039.70	2252.94
	Height Adjustable	SJTC-	0-401A	A	1676.31	1724.05	1775.23	1799.16	1819.60	1863.97	1904.90	2014.08	2111.31	2324.55
	4D	SJTC-	0-701A	A	1707.61	1755.35	1806.53	1830.46	1850.90	1895.27	1936.20	2045.38	2142.61	2355.85
<b>No Lumbar Adjustment - Upholstered Back</b>														
Fixed Seat	No arm	SJTC-	-001X	A	\$1638.25	\$1733.73	\$1836.09	\$1883.95	\$1924.83	\$2013.57	\$2095.43	\$2313.79	\$2508.25	\$2934.73
	Fixed	SJTC-	-101X	A	1731.81	1827.29	1929.65	1977.51	2018.39	2107.13	2188.99	2407.35	2601.81	3028.29
	Height Adjustable	SJTC-	-401X	A	1803.42	1898.90	2001.26	2049.12	2090.00	2178.74	2260.60	2478.96	2673.42	3099.90
	4D	SJTC-	-701X	A	1834.72	1930.20	2032.56	2080.42	2121.30	2210.04	2291.90	2510.26	2704.72	3131.20
Seat Depth Adjustment	No arm	SJTC-	-001A	A	1670.12	1765.60	1867.96	1915.82	1956.70	2045.44	2127.30	2345.66	2540.12	2966.60
	Fixed	SJTC-	-101A	A	1763.68	1859.16	1961.52	2009.38	2050.26	2139.00	2220.86	2439.22	2633.68	3060.16
	Height Adjustable	SJTC-	-401A	A	1835.29	1930.77	2033.13	2080.99	2121.87	2210.61	2292.47	2510.83	2705.29	3131.77
	4D	SJTC-	-701A	A	1866.59	1962.07	2064.43	2112.29	2153.17	2241.91	2323.77	2542.13	2736.59	3163.07
<b>Lumbar Adjustment - Knit Back</b>														
Fixed Seat	No arm	SJTC-	0-011X	A	\$1552.06	\$1599.80	\$1650.98	\$1674.91	\$1695.35	\$1739.72	\$1780.65	\$1889.83	\$1987.06	\$2200.30
	Fixed	SJTC-	0-111X	A	1645.62	1693.36	1744.54	1768.47	1788.91	1833.28	1874.21	1983.39	2080.62	2293.86
	Height Adjustable	SJTC-	0-411X	A	1717.23	1764.97	1816.15	1840.08	1860.52	1904.89	1945.82	2055.00	2152.23	2365.47
	4D	SJTC-	0-711X	A	1748.53	1796.27	1847.45	1871.38	1891.82	1936.19	1977.12	2086.30	2183.53	2396.77
Seat Depth Adjustment	No arm	SJTC-	0-011A	A	1583.93	1631.67	1682.85	1706.78	1727.22	1771.59	1812.52	1921.70	2018.93	2232.17
	Fixed	SJTC-	0-111A	A	1677.49	1725.23	1776.41	1800.34	1820.78	1865.15	1906.08	2015.26	2112.49	2325.73
	Height Adjustable	SJTC-	0-411A	A	1749.10	1796.84	1848.02	1871.95	1892.39	1936.76	1977.69	2086.87	2184.10	2397.34
	4D	SJTC-	0-711A	A	1780.40	1828.14	1879.32	1903.25	1923.69	1968.06	2008.99	2118.17	2215.40	2428.64
<b>Lumbar Adjustment - Upholstered Back</b>														
Fixed Seat	No arm	SJTC-	-011X	A	\$1711.04	\$1806.52	\$1908.88	\$1956.74	\$1997.62	\$2086.36	\$2168.22	\$2386.58	\$2581.04	\$3007.52
	Fixed	SJTC-	-111X	A	1804.60	1900.08	2002.44	2050.30	2091.18	2179.92	2261.78	2480.14	2674.60	3101.08
	Height Adjustable	SJTC-	-411X	A	1876.21	1971.69	2074.05	2121.91	2162.79	2251.53	2333.39	2551.75	2746.21	3172.69
	4D	SJTC-	-711X	A	1907.51	2002.99	2105.35	2153.21	2194.09	2282.83	2364.69	2583.05	2777.51	3203.99
Seat Depth Adjustment	No arm	SJTC-	-011A	A	1742.91	1838.39	1940.75	1988.61	2029.49	2118.23	2200.09	2418.45	2612.91	3039.39
	Fixed	SJTC-	-111A	A	1836.47	1931.95	2034.31	2082.17	2123.05	2211.79	2293.65	2512.01	2706.47	3132.95
	Height Adjustable	SJTC-	-411A	A	1908.08	2003.56	2105.92	2153.78	2194.66	2283.40	2365.26	2583.62	2778.08	3204.56
	4D	SJTC-	-711A	A	1939.38	2034.86	2137.22	2185.08	2225.96	2314.70	2396.56	2614.92	2809.38	3235.86

\*Pricing based on plastic base with hard casters.

The following options require modification of the product number.

- Stain Repellent
- Fully Cleanable Back

To specify, add **P** to the end of the product number (add **\$53.08** list); **Example:** SJTC-20-001X1AP  
 To specify, change the 5th digit to **C** (add **\$41.68** list to upholstered back list price); **Example:** SJTC-3C-001X1A  
**Note:** Inner back must be Faux Leather to have a fully cleanable back.

# Breck

## At-A-Glance

**Designer** Haworth Design Studio.

**Breck** Simple, intuitive, and responsive, Breck epitomizes efficiency in comfort. Breck's Geostretch™ back provides the optimal ratio of lumbar to thoracic support, while a weight-activated mechanism easily responds to the way you sit and recline. With a seat pan influenced by 20+ years of research and its Flexion™ back, Breck moves with you, providing support for a range of body shapes and sizes.

**Awards** Best of Neocon Gold 2024  
Best of Neocon Sustainability 2024  
Metropolis Likes 2024

**Environmental Factors**

- Refer to Product Environmental Data sheet (PED) for recycled content and certifications.
- Breck is produced in an ISO 14001 certified manufacturing facility.
- Components are identified with ISO recycling symbols and material information to assist in the recycling effort, where practical.
- Haworth will take back Breck chairs after their useful life and recycle the components. Please contact Haworth's Material Recovery Center at (616) 393-1215.

**Shipping Weights/Cube (Including packaging)**

- Chairs:
  - Knocked Down: 38 lbs. / 1 chair per carton / 9.33 cubic feet
  - Assembled: 38 lbs. / 1 chair per carton / 22.1 cubic feet
- Stools:
  - Assembled: 41 lbs. / 1 stool per carton / 22.1 cubic feet

**Specifications** Designed for use by individuals up to 325 lbs.

## Features and Adjustments

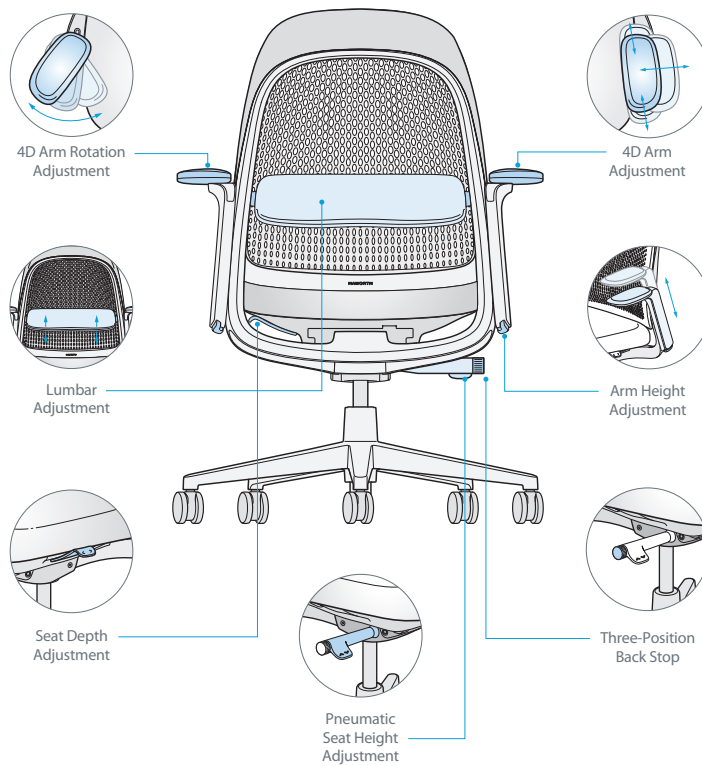

# Breck

## At-A-Glance

### Catalog Logic

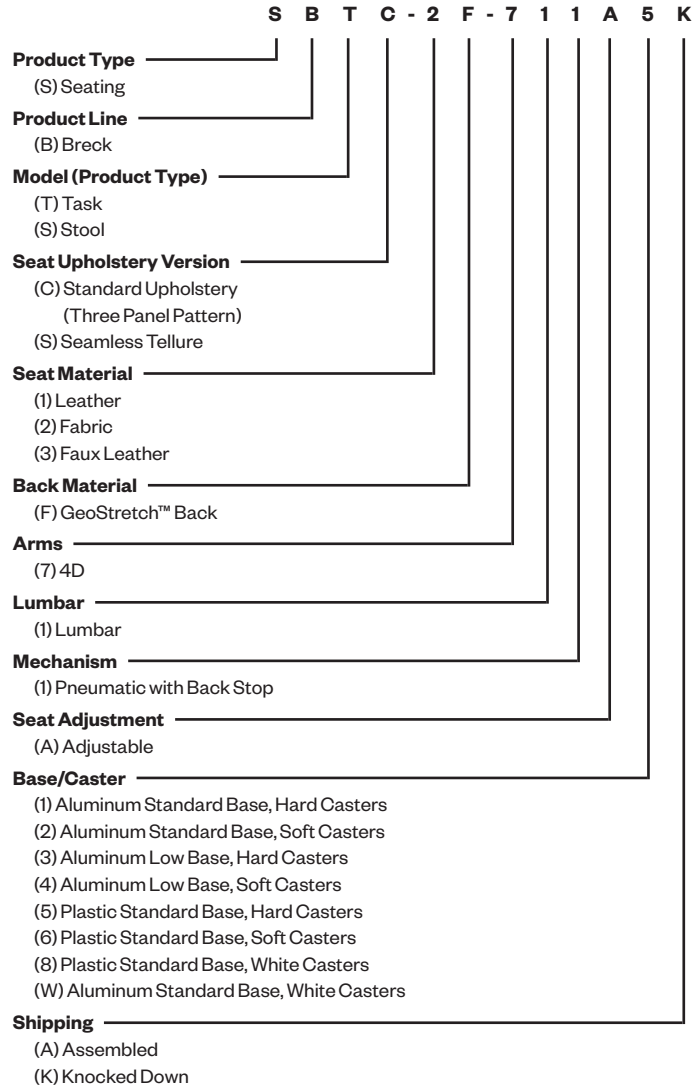

# Breck

## At-A-Glance — Standard Mobility and Adjustability

### Seat Height Adjustment

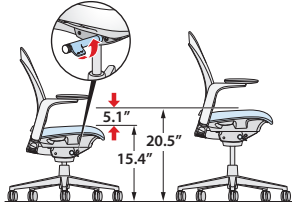

#### Features

- Pneumatic seat height adjustment.
- Seat height adjusts 5.1"(130mm) from 15.4"(391mm) to 20.5"(521mm) in standard models. Low-position adjusts from 14.5"(356mm) to 17.2"(437mm).
- Stool height adjusts 7.6"(193mm) from 20.9"(531mm) to 28.5"(724mm).

#### Benefits

- Ensures the comfort of the lower limbs by avoiding pressure on the underside of the thigh caused by a seat pan that is too high, or decreased thigh-to-torso angle if the seat is too low.
- Seat height adjustment is important in setting the proper hand position and allowing for proper sitting eye height as well.

### Seat Depth Adjustment



#### Feature

- Seat depth has 2"(51mm) seat depth range.

#### Benefit

- Supports the thighs, allows users to rest against the seat back for back support, and avoids pressure on the back of the knees of small to tall users.

### Synchronous Tilt



#### Features

- Back reclines 23° from the upright position.
- 3:1 recline ratio.

#### Benefits

- Comfortable relaxed posture.
- Recline allows for the opening of the user's chest cavity providing good airflow to promote alertness.
- Minimizes front edge seat rise.

### Weight Activated Recline

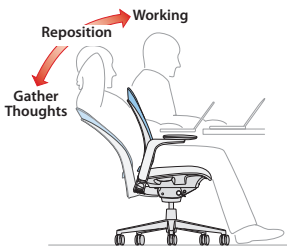

#### Feature

- Mechanism easily responds to the way you sit and recline.

#### Benefit

- Adjusts to user's body weight to provide essential support to a wide range of users.

### Back Stop

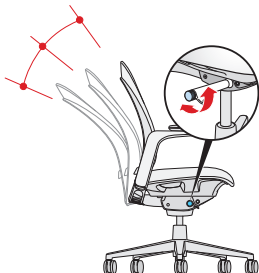

#### Feature

- Back Stop stops in 3 positions, upright and every 7.5° of back angle.

#### Benefit

- Allows users the choice of selecting an upright position or limiting the amount of recline while performing different tasks.

# Breck

## At-A-Glance — Standard Mobility and Adjustability

### GeoStretch™ Back

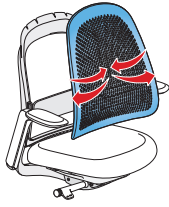

#### Feature

- High performance elastomer provides a flexible and supportive back suspension system.

#### Benefits

- Integrates 3<sup>rd</sup> party pressure map research into back pattern to provide optimal ratio of support in pelvic, lumbar and thoracic region.
- Eliminates pressure points.

### Lumbar



#### Features

- Height adjustable lumbar.
- Range of 2.5"(64mm) of height adjustment.
- Lumbar color will coordinate with GeoStretch™ back color.

#### Benefit

- Lumbar adjustment maintains the natural curvature of the spine at the lower back and allows user to position the support to where it is most comfortable.

### 4D Arm

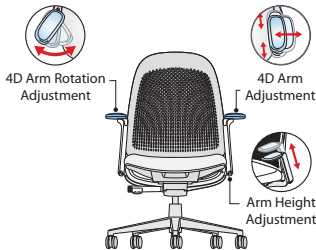

#### Features

- Height adjustment 4"(102mm).
- Side-to-side arm cap adjustment range: 5"(127mm) [2.5"(64mm) each arm cap].
- Front-to-back adjustment range: 3.75"(95mm).
- Pivoting 40° in and 40° out.

#### Benefits

- Arms support the muscular system of user's neck and shoulders; proper arm support provides back relief.
- Arms can be an aid in standing or sitting down.
- Height adjustment accommodates for users with varying elbow rest heights so that users avoid lifting their shoulders or leaning sideways to get arm support.
- Front-to-back adjustment adjusts the armrest length, which is important because it allows users to get close to the worksurface while maintaining the effective use of the backrest.
- Side-to-side adjustment ensures a comfortable resting position for the arms with proper support of the forearm while allowing for easy entry/exit of the chair.
- Pivoting provides proper support of the forearm when performing tasks involving keying and mousing.

### Seat Upholstery

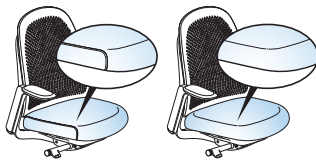

Standard Upholstery  
(three Panel Pattern)

Seamless Tellure  
Upholstery

#### Features

- Standard Upholstery model will have a 3-panel pattern with a seam on the left and right-hand side of the seat surface (see illustration).
- Seamless Tellure Seat model is available in Tellure seating fabric only, and will be a single piece of material with no seams.

# Breck

## At-A-Glance — Standard Mobility and Adjustability

---

### Base

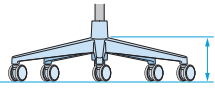

Standard Plastic Base

**Colors**

TR-F Black  
TR-UFM Snow

**Casters**

Hard casters in Black or Two-Tone White  
Soft casters in Black

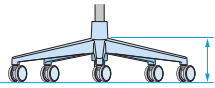

Optional Aluminum Base

**Colors**

PM-P Polished Aluminum only

**Casters**

Hard or Soft casters in Black

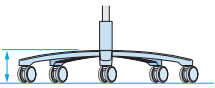

Low Position Base  
(Aluminum only)

**Colors**

TR-UFSSnowfall  
TR-TF Pitch

**Casters**

Hard or Soft casters in Black

**Note:** Low position base not available on stool.

# Breck

## Task Chair



SBTS  
Class BR

### Features

- Back: GeoStretch™ back made from high performance flexible elastomer.
- Seat: Upholstered with 2" (51mm) adjustable seat depth range. Seat will have three panel upholstery with seams on each side unless seamless Tellure model is ordered.
- Base Options:
  - Plastic standard five-star base.  
Casters: Hard casters in black or two-tone white; Soft casters in black only.
  - Aluminum standard five-star base.  
Casters: Hard casters in black or two-tone white; Soft casters in black only.
  - Aluminum low-position five-star base.  
Casters: Hard or soft casters in black only.
- Arms: Standard with 4D arms.
- Arm Caps: Black trim will have black arm cap. Snow trim will have Fog arm cap.
- Height adjustment: Pneumatic or low-position pneumatic.
- Back Stop: Tilt stop in three positions.
- Recline: Weight activated recline.
- Lumbar: Translucent lumbar coordinates with seat back.
- COM yardage / COL square footage:  
(Seat only) 0.75/8

### Specification Tips

- Ships standard as knocked down (KD) with minor assembly required. No tools necessary.
- Assembled option available.

### Dimensions

Height:	Depth:	Width:
H: 39-44" (991-1118mm)	D: 28.5"(724mm) *SD: 15.2-17.2" (386-437mm)	W: 28.5"(724mm) *SW: 19.5"(495mm)
*SH: 15.4-20.5" (391-521mm)		
*AH: 7.9-11.6" (201-295mm)		
Low position SH: 14.5-17.2"(368-437mm)		

\*Measurements taken with the BIFMA chair measuring device.

### To Order, Specify:

1) Product number, including:

#### 1 Seat Upholstery:

- 1 Leather
- 2 Fabric
- 3 Faux Leather

#### 2 Base/Caster Option:

##### Plastic Base

- 5 Plastic Base, Hard Caster
- 6 Plastic Base, Soft Caster (add **\$36.05** list)
- 8 Plastic Base, Two-Tone White Caster (add **\$36.05** list)

##### Aluminum Base

- 1 Aluminum Base, Hard Caster (add **\$185.40** list)
- 2 Aluminum Base, Soft Caster (add **\$221.45** list)
- W Aluminum Base, Two-Tone White Caster (add **\$221.45** list)

##### Low Base - Aluminum

- 3 Aluminum Low Base, Hard Caster (add **\$185.40** list)
- 4 Aluminum Low Base, Soft Caster (add **\$221.45** list)

- 2) Seat upholstery.
- 3) Back color<sup>1</sup>.
- 4) Trim color<sup>2</sup>.  
TR-F Black  
TR-UFM Snow (add **\$110.00** list)
- 5) Base color.  
*Plastic:*  
TR-F Black  
TR-UFM Snow  
*Aluminum:*  
PM-P Polished aluminum only.  
*Low Position Aluminum:*  
TR-TF Pitch  
TR-UFS Snowfall

<sup>1</sup> GeoStretch™ back and coordinating translucent lumbar.  
TR-2B Agave  
TR-F Black  
TR-2C Lagoon  
TR-2A Lunar  
TR-2E Rosewater  
TR-2D Stone

<sup>2</sup> Back frame, seat shell and arm upright.

**Note:** When Snow trim is specified armcaps and adjustment levers will default to TR-7 Fog.

Plastic Base* Description	Number		Fabric								Leather	
	1	2	A	B	C	D	E	F	G	H	A	B
Standard Upholstery	SBTC- F-711A	K	\$849.24	\$918.79	\$931.01	\$952.15	\$967.96	\$1006.23	\$1040.51	\$1134.19	\$1209.74	\$1389.99
Seamless Tellure Seat	SBTS- F-711A	K	\$802.89	N/A	N/A	N/A	N/A	N/A	N/A	N/A	N/A	N/A

\*Pricing based on Plastic base with hard casters.

The following options require modification of the product number.

- Assembled To specify, change the last digit from **K** to **A** (add **\$175.10** list); **Example:** SBTC-2F-711A5A
- Stain repellent To specify, add **P** to the end of the product number (add **\$41.84** list); **Example:** SBTC-2F-711A5KP

# Breck Stool

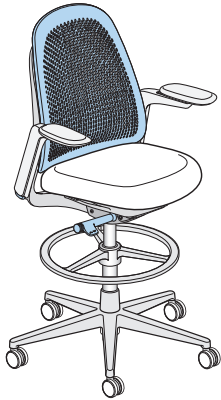

SBSS  
Class BR

### Features

- Back: GeoStretch™ back made from high performance flexible elastomer.
- Seat: Upholstered with 2" (51mm) adjustable seat depth range. Seat will have three panel upholstery with seams on each side unless seamless Tellure model is ordered.
- Base Options:
  - Plastic standard five-star base.  
Casters: Hard casters in black or two-tone white; Soft casters in black only.
  - Aluminum standard five-star base.  
Casters: Hard casters in black or two-tone white; Soft casters in black only.
- Arms: Standard with 4D arms.
- Footring standard in polished aluminum.
- Arm Caps: Black trim will have black arm cap. Snow trim will have Fog arm cap.
- Height adjustment: Pneumatic.
- Back Stop: Tilt stop in three positions.
- Recline: Weight activated recline.
- Lumbar: Translucent lumbar coordinates with seat back.
- COM yardage / COL square footage:  
(Seat only) 0.75/8

### Specification Tip

- Stool ships assembled.

### Dimensions

Height:	Depth:	Width:
H: 44.5-52" (1130-1321mm)	D: 28.5"(724mm) *SD: 15.2-17.2" (386-437mm)	W: 28.5"(724mm) *SW: 19.5"(495mm)
*SH: 20.9-28.5" (531-727mm)		
*AH: 7.9-11.6" (201-295mm)		

\*Measurements taken with the BIFMA chair measuring device.

### To Order, Specify:

1) Product number, including:

#### 1 Seat Upholstery:

- 1 Leather
- 2 Fabric
- 3 Faux Leather

#### 2 Base/Caster Option:

##### Plastic Base

- 5 Plastic Base, Hard Caster
- 6 Plastic Base, Soft Caster  
(add **\$36.05** list)
- 8 Plastic Base, Two-Tone White Caster  
(add **\$36.05** list)

##### Aluminum Base

- 1 Aluminum Base, Hard Caster (add **\$185.40** list)
- 2 Aluminum Base, Soft Caster  
(add **\$221.45** list)
- W Aluminum Base, Two-Tone White Caster  
(add **\$221.45** list)

2) Seat upholstery.

3) Back color<sup>1</sup>.

4) Trim color<sup>2</sup>.

TR-F Black  
TR-UFM Snow (add **\$110.00** list)

5) Base color.

*Plastic:*

TR-F Black  
TR-UFM Snow

*Aluminum:*

PM-P Polished aluminum only.

<sup>1</sup> GeoStretch™ back and coordinating translucent lumbar.  
TR-2B Agave  
TR-F Black  
TR-2C Lagoon  
TR-2A Lunar  
TR-2E Rosewater  
TR-2D Stone

<sup>2</sup> Back frame, seat shell and arm upright.

**Note:** When Snow trim is specified armcaps and adjustment levers will default to TR-7 Fog.

Plastic Base* Description	Number		Fabric								Leather		
	1	2	A	B	C	D	E	F	G	H	A	B	
Standard Upholstery	SBSC-	F-711A	A	\$ 1106.74	\$1176.29	\$1188.51	\$1209.65	\$1225.46	\$1263.73	\$1298.01	\$1391.69	\$1467.24	\$1647.49
Seamless Tellure Seat	SBSS-	F-711A	A	\$1060.39	N/A	N/A	N/A	N/A	N/A	N/A	N/A	N/A	N/A

\*Pricing based on Plastic base with hard casters.

The following options require modification of the product number.

Stain repellent

To specify, add **P** to the end of the product number (add **\$41.84** list); **Example:** SBSC-2F-711A5AP

# Veda

## At-A-Glance

### Veda by Danielle Gollinucci

A light-scale, multipurpose chair providing essential comfort across a breadth of applications. Flexible yet supportive - its flawless curvature and minimal mass convey form and function rooted in decades of Italian design heritage.

### Specifications

Designed for use by individuals up to 325 lbs.

### Catalog Logic

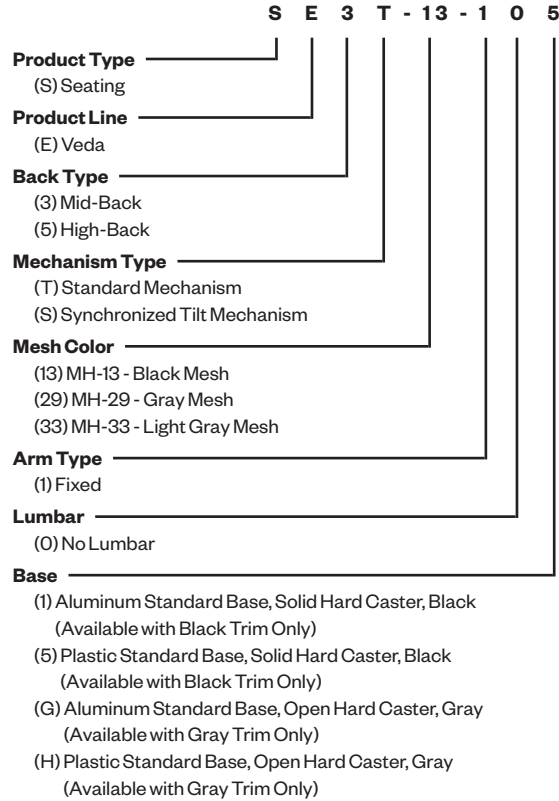

# Veda

## At-A-Glance

### Seat Height Adjustment

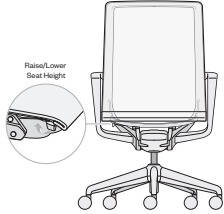

#### Features

- Pneumatic seat height adjustment.
- Seat height adjusts from 16.7" to 20.9"H(424mm-531mm).

#### Benefits

- Ensures comfort of lower limbs by avoiding pressure on the underside of the thigh caused by a seat that is too high, or decreased thigh-to-torso angle if the seat is too low.
- Seat height adjustment is important in setting the proper hand position and allowing for proper sitting eye height as well.

### Standard Tilt

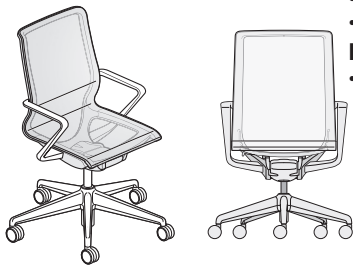

#### Features

- Weight assisted recline mechanism tilts backward 14° from upright position.
- Available on the Mid-Back chair only.

#### Benefit

- Provides essential comfort without complicated adjustments.

### Synchronized Tilt

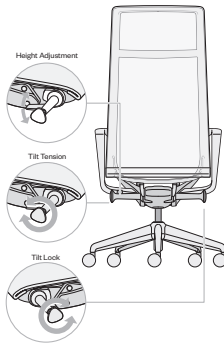

#### Features

- One piece mesh construction with patented hinge system allows for synchronized recline at a 2:1 ratio.
- Standard with tilt tension adjustment - accommodating full range of tension within one complete revolution.
- Standard with five position tilt lock, four back and one upright position.
- Available on both Mid-Back and High-Back chair.

#### Benefits

- Comfortable, relaxed posture while keeping your feet on the ground.
- Recline allows for the opening of the user's chest cavity.
- Allows user the opportunity to vary their posture throughout the day.

### Base

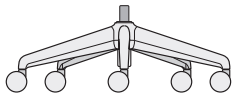

#### Features

- Plastic or aluminum.
  - Plastic: Black or Gray
  - Aluminum: Polished Aluminum only
- Plastic base color must match frame color.

### Casters

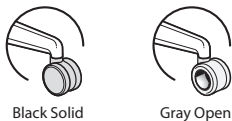

#### Features

- Hard casters only.
- Caster style and color determined by frame color.
  - Black frame: Black solid casters.
  - Gray frame: Gray open casters.

# Veda

## Mid-Back Chair

### Standard Tilt



SE3T  
Class VE

#### Features

- Back and Seat: One piece mesh construction.
- Black Mesh and Frame.
- Base: Plastic or aluminum five-star base.
  - Plastic base available in Black.
  - Aluminum base available in Polished Aluminum.
- Arms: Fixed height arms.
- Casters: Solid hard casters in black.
- Weight assisted recline mechanism.
- Back tilts backward 14° from upright position.
- COM/COL not available.
- **Ships KD and requires tool-less assembly.**

#### Dimensions

Height:	Depth:	Width:
H: 40.3-44.5" (1024-1130mm)	D: 27.5"(699mm) *SD: 16.8"(427mm)	W: 27.5"(699mm) *SW: 19.6"(498mm)
*SH: 16.7-20.9" (424-531mm)		
*AH: 8.6"(218mm)		

*\*Measurements taken with the BIFMA chair measuring device.*

#### To Order, Specify:

- 1) Product number
- 2) Frame color.  
TR-F Black
- 3) Base color.  
Plastic - TR-F Black  
Aluminum - PM-P Polished  
Aluminum

Description	Number	Price
<b>Plastic Base</b>		
Black Mesh / Black Frame	SE3T-13-105	\$1249.32
<b>Aluminum Base</b>		
Black Mesh / Black Frame	SE3T-13-101	\$1386.68

### Synchronized Tilt



SE3S  
Class VE

#### Features

- Back and Seat: One piece mesh construction.
- Base: Plastic or aluminum five-star base.
  - Plastic base available in black or gray.
  - Aluminum base available in Polished Aluminum.
- Arms: Fixed height arms.
- Mechanism: Synchronized tilt mechanism allows back and seat to adjust in tandem; standard with tilt tension adjustment.
- Back reclines 23.5° from upright position; standard with back lock.
- Frame: Available in Black or Gray Frame.
- Casters: Black frame will have solid hard casters in black. Gray frame will have open hard casters in gray.
- Mesh available in black, gray or light gray.
  - Black mesh available with black frame only.
  - Gray mesh available with black or gray frame.
  - Light gray mesh available with gray frame only.
- COM/COL not available.
- **Ships KD and requires tool-less assembly.**

#### Dimensions

Height:	Depth:	Width:
H: 40.3-44.5" (1024-1130mm)	D: 27.5"(699mm) *SD: 16.8"(427mm)	W: 27.5"(699mm) *SW: 19.6"(498mm)
*SH: 16.7-20.9" (424-531mm)		
*AH: 8.6"(218mm)		

*\*Measurements taken with the BIFMA chair measuring device.*

#### To Order, Specify:

- 1) Product number
  - 2) Frame color.  
TR-F Black  
TR-GRY Gray
  - 3) Base color.  
Plastic - TR-F Black  
TR-GRY Gray  
Aluminum - PM-P Polished  
Aluminum
- Note:** Plastic base color must match frame color.

Description	Number	Price
<b>Plastic Base</b>		
Black Mesh / Black Frame	SE3S-13-105	\$1406.30
Gray Mesh / Black Frame	SE3S-29-105	1406.30
Gray Mesh / Gray Frame	SE3S-29-10H	\$1563.27
Light Gray Mesh / Gray Frame	SE3S-33-10H	1563.27
<b>Aluminum Base</b>		
Black Mesh / Black Frame	SE3S-13-101	\$1543.66
Gray Mesh / Black Frame	SE3S-29-101	1543.66
Gray Mesh / Gray Frame	SE3S-29-10G	\$1700.63
Light Gray Mesh / Gray Frame	SE3S-33-10G	1700.63

# Veda

## High-Back Chair

### Synchronized Tilt



SE5S  
Class VE

#### Features

- Back and Seat: One piece mesh construction.
- Base: Plastic or aluminum five-star base.
  - Plastic base available in black or gray.
  - Aluminum base available in Polished Aluminum.
- Arms: Fixed height arms.
- Mechanism: Synchronized tilt mechanism allows back and seat to adjust in tandem; standard with tilt tension adjustment.
- Back reclines 23.5° from upright position; standard with back lock.
- Frame: Available in Black or Gray Frame.
- Casters: Black frame will have solid hard casters in black. Gray frame will have open hard casters in gray.
- Mesh available in black, gray or light gray.
  - Black mesh available with black frame only.
  - Gray mesh available with black or gray frame.
  - Light gray mesh available with gray frame only.
- COM/COL not available.
- **Ships KD and requires tool-less assembly.**

#### Dimensions

Height:	Depth:	Width:
H: 50.5-54.7" (1283-1389mm)	D: 27.5"(699mm) *SD: 16.8"(427mm)	W: 27.5"(699mm) *SW: 19.6"(498mm)
*SH: 16.7-20.9" (424-531mm)		
*AH: 8.6"(218mm)		

\*Measurements taken with the BIFMA chair measuring device.

#### To Order, Specify:

- 1) Product number
- 2) Frame color.
  - TR-F Black
  - TR-GRY Gray
- 3) Base color.
  - Plastic - TR-F Black
  - TR-GRY Gray
  - Aluminum - PM-P Polished
  - Aluminum

**Note** Plastic base color must match frame color.

Description	Number	Price
<b>Plastic Base</b>		
Black Mesh / Black Frame	SE5S-13-105	\$1569.82
Gray Mesh / Black Frame	SE5S-29-105	1569.82
Gray Mesh / Gray Frame	SE5S-29-10H	\$1726.80
Light Gray Mesh / Gray Frame	SE5S-33-10H	1726.80
<b>Aluminum Base</b>		
Black Mesh / Black Frame	SE5S-13-101	\$1707.18
Gray Mesh / Black Frame	SE5S-29-101	1707.18
Gray Mesh / Gray Frame	SE5S-29-10G	\$1864.16
Light Gray Mesh / Gray Frame	SE5S-33-10G	1864.16

# Improv

## At-A-Glance

### Features and Options (Leg-Base and Sled-Base Chairs)

- Improv leg-base and sled-base models feature
- 14-gauge elliptical steel tubing legs
  - 14-gauge steel side and front stretchers (with arms and chairs with casters)
  - 11-gauge steel front stretchers (without arms)
  - Molded polyurethane seat and back foam
  - Optional wood back
  - Polypropylene or upholstered outer back shell, or full wood back
  - High-density polyethylene floor glides (leg-base models)
  - Leg base models available with caster option
  - Glass-filled nylon sled-base runners with high-density polyethylene floor glides (sled-base models)
  - Powder coated frame
  - Ganging device option
  - Leg-base models with arms stack 6-high (44"(1118mm)) on the floor and 10-high (62"(1575mm)) on the stacking dolly
  - Leg-base armless models stack 6-high (44"(1118mm)) on the floor and 10-high (58"(1473mm)) on the stacking dolly
  - Leg-base models with casters stack 5-high (42"(1067mm)) on the floor and 6-high (50"(1270mm)) on the stacking dolly
  - Wood back model has same stacking capabilities as the leg-base models
- Arm chair models feature:
- Glass reinforced polypropylene arms
- Armless models feature:
- High-density polyethylene top caps on exposed legs
- Improv series chairs meet or exceed ANSI/BIFMA durability standards for office seating.

### Shipping Weights (Leg-Base and Sled-Base Chairs)

- The following weights include packaging materials
- All leg-base and sled-base chairs 25 lbs. per chair/9.6 cubic ft. (up to 3 chairs per carton)
  - 20"(508mm) diameter tables 19 lbs./5.3 cubic ft.
  - 24" x 48"(610mm x 1219mm) oval tables 35 lbs./11 cubic ft.
  - Chairs without tablet arms are packaged three (3) per carton
  - Chairs with tablet arms are packaged two (2) per carton
  - Chairs with leather seats are packaged one (1) per carton
- Note:** Models with casters: add one (1) pound per chair

### Features and Options (Stools)

- All Improv stools feature
- 14-gauge elliptical steel tubing legs
  - 14-gauge steel side and front stretchers
  - 14-gauge steel foot rest with lightly textured protective nylon cover
  - Molded polyurethane seat foam, 1.375"(35mm) thick
  - Molded polyurethane back foam, 0.875"(22mm) thick
  - Optional wood back
  - Polypropylene (0.75"(19mm)) or upholstered (1.25"(32mm)) seat and back shell
  - High-density polyethylene floor glides
  - Glass reinforced polypropylene arms or high-density polyethylene top caps on exposed legs
  - Powder coated frame

### Shipping Weights (Stools)

- The following weights do not include packaging materials.
- Stool with arms: 30 lbs./13.608k  
 Stool without arms: 27 lbs./12.247k

# Improv

## At-A-Glance

### Environmental Factors

Material Off Gassing

In an effort to ensure air quality standards, all Improv parts suppliers are required to provide Material Data Sheets and/or other documentation, verifying that their products do not emit volatile organic compounds (VOCs). In addition, the powder-coat paint process used in the manufacturing of Improv seating is free of VOCs. Our manufacturing processes have also eliminated all use of chlorofluorocarbons (CFCs) and ozone depleting chemicals (ODCs) in the chair's construction.

Recycling

All fabric scraps are recycled, reducing the amount of material sent to landfills, and all chair components disassemble easily to increase the potential for recycling. In addition, all thermo-plastic parts are 100% reprocessible, and all raw materials used in its manufacturing can be recycled at the end of the useful life of the product. Recyclable parts are identified with the recycle symbol where practical.

### Finishes and Fabrics

A complete listing of finishes and fabrics for Improv desk chairs can be found in the back of the price list.

### COM & COL General Information

To order a COM fabric (Customer's Own Material), contact the Haworth Inquiry Center (1.800.426.8562), your local Haworth dealer, or go to [haworth.com/surfaces](http://haworth.com/surfaces) to find out if the COM you have selected has already been tested and approved. The surface collection site also has information on the Haworth alliance program with Carnegie, Luna Textiles, and Maharam as well as our industry-leading Pre-Approved COM program.

COM fabrics are placed into Grades based on the cost per linear yard. If a fabric's cost exceeds the range of our highest Grade it will be noted as Non-Graded. The product will be priced at Grade A; the COM fabric costs will appear as a separate line item. The fabric charge will be Haworth's purchase cost plus a 4% administrative fee (based on the cost of the fabric). Yardage calculations will include any applicable fabric repeat.

COM Leather products will be priced at a leather Grade A; COL costs will appear as a separate line item. The leather costs will be Haworth's purchase cost plus a 4% administrative fee (based on the cost of the leather).

### Specifications

Designed for use by individuals up to 325 lbs.

# Improv

## At-A-Glance

### Catalog Logic

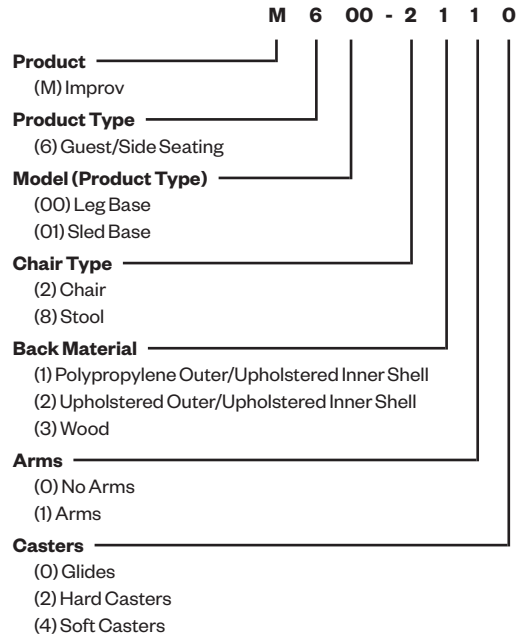

# Improv

## Leg-Base Stacking Chairs

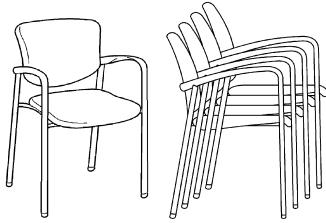

M600-2110



M600-2310  
Class JA

### Features

- Optional: Full wood back.
- Optional: Legs with casters.
- Polypropylene or upholstered outer back shell.
- Armless stacks 6-high (44"(1118mm)) on floor or 10-high (62"(1575mm)) on stacking dolly.
- With arms stacks 5-high (42"(1067mm)) on floor or 6-high (50"(1270mm)) on dolly.
- Arms and molded floor glides match frame color except when ordering Metallic trim; molded components are available in black or smoke and must be specified.
- Non-ganging or ganging options.
- Fire retardant construction is available to comply with California Bulletin #133, see below.
- COM yardage/COL square footage:  
Polypropylene back shell/upholstered seat: 0.75/15  
Upholstered shell/seat: 1.25/28  
Upholstered seat (wood back): 0.5

### Dimensions

Height:	Depth:	Width:
H: 32"(813mm)	D: 21.5"(546mm)	W: 22"(559mm)
*SH: 18"(457mm)	*SD: 18"(457mm)	*SW: 19"(483mm)
*AH: 25.75"(654mm)		

\*Measurements taken with the BIFMA chair measuring device.

### To Order, Specify:

- 1) Product number.
- 2) Fabric surface and color.
- 3) Frame/arms trim color.
- 4) Arm and glide trim color for metallic frame; black or smoke option only (if applicable).

### To Order Chair with Wood Back, Specify:

- 1) Product number.
- 2) Fabric surface and color (seat).
- 3) Frame trim color.
- 4) Arm and glide trim color for metallic frame; black or smoke option only (if applicable).
- 5) Wood back finish color.

Ganging	Arms	Number	Fabric								Leather	
			A	B	C	D	E	F	G	H	A	B
<b>Polypropylene Outer Shell/Upholstered Inner Shell</b>												
Non-Ganging	Arms	M600-2110	\$ 852.46	\$ 912.26	\$ 936.62	\$ 991.98	\$1042.88	\$ 1126.98	\$ 1186.78	\$1350.58	\$1439.18	\$ 1729.88
	Armless	M600-2100	801.54	861.34	885.70	941.06	991.96	1076.06	1135.86	1299.66	1388.26	1678.96
Ganging	Arms	M600-2110-5	954.31	1014.11	1038.47	1093.83	1144.73	1228.83	1288.63	1452.43	1541.03	1831.73
	Armless	M600-2100-5	903.39	963.19	987.55	1042.91	1093.81	1177.91	1237.71	1401.51	1490.11	1780.81
<b>Upholstered Outer Shell/Upholstered Inner Shell</b>												
Non-Ganging	Arms	M600-2210	\$ 971.98	\$ 1051.75	\$ 1104.89	\$ 1182.41	\$1264.27	\$1348.41	\$ 1417.03	\$1625.14	\$ 1773.50	\$ 2228.04
	Armless	M600-2200	921.06	1000.83	1053.97	1131.49	1213.35	1297.49	1366.11	1574.22	1722.58	2177.12
Ganging	Arms	M600-2210-5	1073.83	1153.60	1206.74	1284.26	1366.12	1450.26	1518.88	1726.99	1875.35	2329.89
	Armless	M600-2200-5	1022.91	1102.68	1155.82	1233.34	1315.20	1399.34	1467.96	1676.07	1824.43	2278.97
<b>Wood Back</b>												
Non-Ganging	Arms	M600-2310	\$1065.03	\$ 1124.83	\$ 1149.19	\$1204.55	\$1255.45	\$1339.55	\$1399.35	\$1563.15	\$ 1651.75	\$ 1942.45
	Armless	M600-2300	1014.11	1073.91	1098.27	1153.63	1204.53	1288.63	1348.43	1512.23	1600.83	1891.53
Ganging	Arms	M600-2310-5	1166.88	1226.68	1251.04	1306.40	1357.30	1441.40	1501.20	1665.00	1753.60	2044.30
	Armless	M600-2300-5	1115.96	1175.76	1200.12	1255.48	1306.38	1390.48	1450.28	1614.08	1702.68	1993.38

The following options require modification of the product number.

Metallic trim color

Hard casters

Soft casters

Stain repellent

Moisture barrier with stain repellent

To specify, add **-M** after the 8th digit; **Example:** M600-2300-5-**M**

To specify, change the 8th digit from a 0 to a 2 (add **\$112.90** list); **Example:** M600-2112

To specify, change the 8th digit from a 0 to a 4 (add **\$177.67** list); **Example:** M600-2114

To specify, add **-P** to the end of the product number (add **\$70.87** list); **Example:** M600-2300-5-**P**

To specify, add **-D** to the end of the product number (add **\$92.98** list); **Example:** M600-2300-5-**D**

**NOTE:** Casters should not be used on thick pile carpet applications.

For available fabrics, refer to [surfaces.haworth.com](http://surfaces.haworth.com).

# Improv

## Sled-Base Chairs — Non-Stacking

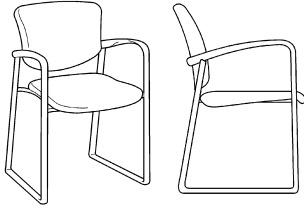

M601-2110

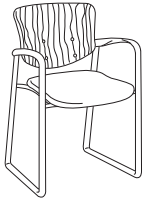

M601-2300  
Class JA

### Features

- Optional: Full wood back.
- Polypropylene or upholstered outer back shell.
- Non-stacking.
- Arms and nylon sled-base runners match frame color except when ordering Metallic trim; molded components are available black or smoke and must be specified.
- Non-ganging or ganging options.
- Fire retardant construction is available to comply with California Bulletin #133, see below.
- COM yardage/COL square footage:  
Polypropylene back shell/upholstered seat: 0.75/15  
Upholstered shell/seat: 1.25/28  
Upholstered seat (wood back): 0.5

### Dimensions

Height:	Depth:	Width:
H: 32"(813mm)	D: 21.5"(546mm)	W: 22"(559mm)
SH: 18"(457mm)	SD: 18"(457mm)	SW: 19"(483mm)
AH: 25.75"(654mm)		

### To Order, Specify:

- 1) Product number.
- 2) Fabric surface and color.
- 3) Frame trim color.
- 4) Arm and sled base runners for metallic frame; black or smoke option only (if applicable).

### To Order Chair with Wood Back, Specify:

- 1) Product number.
- 2) Fabric surface and color (seat).
- 3) Frame trim color.
- 4) Arm and sled base runners for metallic frame; black or smoke option only (if applicable).
- 5) Wood back finish color.

Ganging	Arms	Number	Fabric								Leather	
			A	B	C	D	E	F	G	H	A	B
<b>Polypropylene Outer Shell/Upholstered Inner Shell</b>												
Non-Ganging	Arms	M601-2110	\$ 1109.28	\$ 1169.08	\$ 1193.44	\$ 1248.80	\$ 1299.70	\$ 1383.80	\$ 1443.60	\$ 1607.40	\$ 1696.00	\$ 1986.70
	Armless	M601-2100	1058.36	1118.16	1142.52	1197.88	1248.78	1332.88	1392.68	1556.48	1645.08	1935.78
Ganging	Arms	M601-2110-5	1211.13	1270.93	1295.29	1350.65	1401.55	1485.65	1545.45	1709.25	1797.85	2088.55
	Armless	M601-2100-5	1160.21	1220.01	1244.37	1299.73	1350.63	1434.73	1494.53	1658.33	1746.93	2037.63
<b>Upholstered Outer Shell/Upholstered Inner Shell</b>												
Non-Ganging	Arms	M601-2210	\$ 1228.80	\$ 1308.57	\$ 1361.71	\$ 1439.23	\$ 1521.09	\$ 1605.23	\$ 1673.85	\$ 1881.96	\$ 2030.32	\$ 2484.86
	Armless	M601-2200	1177.88	1257.65	1310.79	1388.31	1470.17	1554.31	1622.93	1831.04	1979.40	2433.94
Ganging	Arms	M601-2210-5	1330.65	1410.42	1463.56	1541.08	1622.94	1707.08	1775.70	1983.81	2132.17	2586.71
	Armless	M601-2200-5	1279.73	1359.50	1412.64	1490.16	1572.02	1656.16	1724.78	1932.89	2081.25	2535.79
<b>Wood Back</b>												
Non-Ganging	Arms	M601-2310	\$ 1321.85	\$ 1381.65	\$ 1406.01	\$ 1461.37	\$ 1512.27	\$ 1596.37	\$ 1656.17	\$ 1819.97	\$ 1908.57	\$ 2199.27
	Armless	M601-2300	1270.93	1330.73	1355.09	1410.45	1461.35	1545.45	1605.25	1769.05	1857.65	2148.35
Ganging	Arms	M601-2310-5	1423.70	1483.50	1507.86	1563.22	1614.12	1698.22	1758.02	1921.82	2010.42	2301.12
	Armless	M601-2300-5	1372.78	1432.58	1456.94	1512.30	1563.20	1647.30	1707.10	1870.90	1959.50	2250.20

The following options require modification of the product number.

Metallic trim color

Stain repellent

Moisture barrier with stain repellent

To specify, add **-M** after the 8th digit; **Example:** M601-2110-**M**

To specify, add **-P** to the end of the product number (add **\$70.87** list); **Example:** M601-2110-**P**

To specify, add **-D** to the end of the product number (add **\$92.98** list); **Example:** M601-2110-**D**

**NOTE:** For available fabrics, refer to [surfaces.haworth.com](http://surfaces.haworth.com).

# Improv Stools

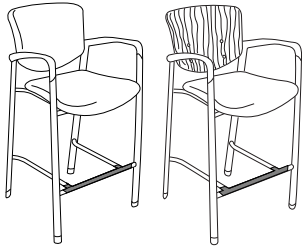

M600-8110

M600-8310

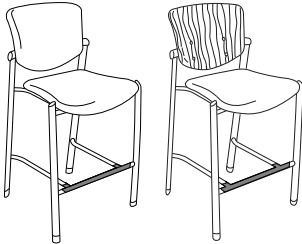

M600-8100

M600-8300

Class JA

### Features

- Optional: Full wood back.
- Polypropylene or upholstered outer back shell.
- Arms and molded floor glides match frame color except when ordering Metallic trim; molded components are available in black or smoke and must be specified.
- Wood back chairs have four color-matched bolts: black, graphite, smoke and Metallic trim chairs are standard with black bolts, and grey tone, stone and tan chairs are standard with blackened bronze bolts.
- Distance between the arms is 19.25"(489mm).
- Foot rest nylon cover is available in charcoal finish color only.
- Fire retardant construction is available to comply with California Bulletin #133, see below.
- COM yardage/COL square footage:  
Polypropylene shell: 0.75/15  
Upholstered shell: 1.25/28  
Upholstered seat (wood back): 0.5

### Dimensions

Height:	Depth:	Width:
H: 41.25"(1048mm)	D: 23"(584mm)	W: 22"(559mm)
SH: 27.5"(699mm)	SD: 18"(457mm)	SW: 19"(483mm)
AH: 35.5"(902mm)		BW: 18.25"(464mm)
FH: 10.5"(267mm)		

### To Order, Specify:

- 1) Product number.
- 2) Fabric surface and color.
- 3) Frame trim color.
- 4) Arms and glides color for metallic frame; black or smoke option only (if applicable).

### To Order Stool with Wood Back, Specify:

- 1) Product number.
- 2) Fabric surface and color (seat).
- 3) Frame trim color.
- 4) Arms and glides color for metallic frame; black or smoke option only (if applicable).
- 5) Wood back finish color.

Arms	Number	Fabric								Leather	
		A	B	C	D	E	F	G	H	A	B
<b>Polypropylene/Upholstered</b>											
Arms	M600-8110	\$1496.75	\$1556.55	\$1580.91	\$1636.27	\$1687.17	\$1771.27	\$1831.07	\$1994.87	\$2083.47	\$2374.17
Armless	M600-8100	1445.83	1505.63	1529.99	1585.35	1636.25	1720.35	1780.15	1943.95	2032.55	2323.25
<b>Upholstered/Upholstered</b>											
Arms	M600-8210	\$1616.27	\$1696.04	\$1749.18	\$1826.70	\$1908.56	\$1992.70	\$2061.32	\$2269.43	\$2417.79	\$2872.33
Armless	M600-8200	1565.35	1645.12	1698.26	1775.78	1857.64	1941.78	2010.40	2218.51	2366.87	2821.41
<b>Wood Back</b>											
Arms	M600-8310	\$1709.32	\$1769.12	\$1793.48	\$1848.84	\$1899.74	\$1983.84	\$2043.64	\$2207.44	\$2296.04	\$2586.74
Armless	M600-8300	1658.40	1718.20	1742.56	1797.92	1848.82	1932.92	1992.72	2156.52	2245.12	2535.82

The following options require modification of the product number.

Metallic trim color

Stain repellent

Moisture barrier with stain repellent

To specify, add **-M** after the 8th digit; **Example:** M600-8100-**M**

To specify, add **-P** to the end of the product number (add **\$70.87** list); **Example:** M600-8100-**P**

To specify, add **-D** to the end of the product number (add **\$92.98** list); **Example:** M600-8100-**D**

**NOTE:** For available fabrics, refer to [surfaces.haworth.com](https://surfaces.haworth.com).

# Improv

## Accessories

### Stacking Dolly

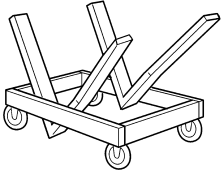

MPRV-CART  
Class JA

**Features**

- 3"(76mm) hard rubber casters.
- Recommended stacking limit is 10 chairs high (58"(1473mm)) armless, 62"(1575mm) with arms, 6-high on casters (50"(1270mm)).
- Entire depth with chairs stacked is 39.75"(1010mm).
- Standard in black finish color only.
- Ships assembled.

**To Order, Specify:**

- 1) Product number.  
(No finish specification required.)

Height	Width	Depth	Number	Price
15"(381mm)	24.25"(616mm)	28"(711mm)	MPRV-CART	\$669.32

### Chair-to-Chair Connecting Bars



MPRV-BARS  
Class JA

**Features**

- Connects two Improv chairs side-by-side.
- Width shown is distance between front legs of adjoining chairs.
- Each chair-to-chair connection requires two connecting bars.
- Price includes two (2) bars.

**To Order, Specify:**

- 1) Product number.
- 2) Trim color.  
To order connecting bars with Metallic trim color add **-M** after eighth digit.  
**Example:** MPRV-BARS-M

Width	Number	Price
1.25"(32mm)	MPRV-BARS	\$99.95

# Improv

## Tandem Seating

### Specification and Ordering Information

Specify standard Improv chair models, and chair-to-chair connecting bars to create a continuous seating configuration.

Use the following guidelines when specifying and ordering Improv seating for tandem configurations:

- 1) Specify the desired chair models.
  - All chair models are designed to accept chair-to-chair connecting bars.
  - NOTE: It is not necessary to order ganging chair models to create a tandem configuration.
- 2) Specify chair-to-chair connecting bars.
  - One set of connecting bars will join two chairs in tandem.

### Specification Example

The following example illustrates a tandem seating configuration.

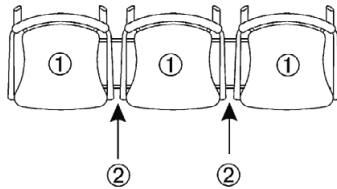

Item	Qty	Number	Description
1	3	M600-2210	Leg-Base Arm Chairs
2	2	MPRV-BARS	Chair-to-Chair Connecting Bars

### Calculating Tandem Seating Dimensions

Use the following dimensions to determine the footprint of an Improv tandem seating configuration.

- 1) All arm and armless chair models are 22"(559mm)W and 21.5"(546mm)D.

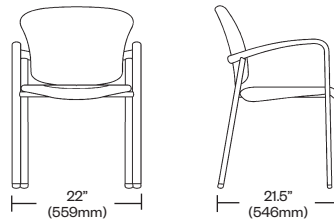

- 2) Add 1.25"(32mm) to the width of the seating run for every chair-to-chair connecting bar.

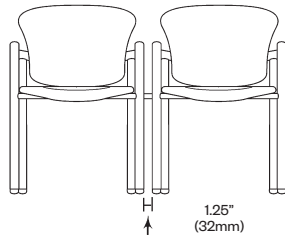

# X99

## At-A-Glance

### Features and Options (Guest Chair)

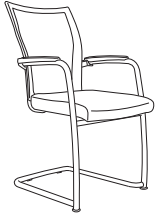

- Upholstered seat
- Soft mesh or upholstered back
- Soft mesh consists of chenille, poly-filament blend
- Black polypropylene arm caps
- Aluminum uprights with welded steel frame
- Finishes include: powder-coated paint (black or silver) and chrome
- Black nylon glides
- Stacks up to 4-high

### Environmental Factors

Material Off Gassing

In an effort to ensure air quality standards, all **X99** parts suppliers are required to provide Material Data Sheets and/or other documentation, verifying their products do not emit volatile organic compounds (VOC). In addition, the powder-coat paint process used in the manufacturing of **X99** seating is free of VOCs. Our manufacturing processes have also eliminated all use of chlorofluorocarbons (CFCs) and ozone depleting chemicals (ODCs) in the chair's construction.

Recycling

All **X99** seating fabric scraps are recycled, reducing the amount of material sent to landfills, and all chair components disassemble easily to increase the potential for recycling. In addition, all thermo-plastic parts are 100% reprocessible, and all raw materials used in its manufacturing can be recycled at the end of the useful life of the product. Recyclable parts are identified with the recycle symbol where practical.

### Finishes and Fabrics

A complete listing of finishes and fabrics for **X99** seating is available in the back of the price list.

### COM & COL General Information

To order a COM fabric (Customer's Own Material), contact the Haworth Inquiry Center (1.800.426.8562), your local Haworth dealer, or go to [haworth.com/surfaces](http://haworth.com/surfaces) > COM Library to find out if the COM you have selected has already been tested and approved. The surface collection site also has information on the Haworth+ alliance program with Carnegie, Luna Textiles, and Maharam as well as our industry-leading Pre-Approved COM program.

COM fabrics are placed into Grades based on the cost per linear yard. If a fabric's cost exceeds the range of our highest Grade it will be noted as Non-Graded. The product will be priced at Grade A; the COM fabric costs will appear as a separate line item. The fabric charge will be Haworth's purchase cost plus a 4% administrative fee (based on the cost of the fabric). Yardage calculations will include any applicable fabric repeat.

COM Leather products will be priced at a leather Grade A; COL costs will appear as a separate line item. The leather costs will be Haworth's purchase cost plus a 4% administrative fee (based on the cost of the leather).

### Shipping Weights (including packaging)

- Guest chair with sled base: 35 pounds/1 chair per carton/19.5 cubic feet
- Seminar chair: 34 pounds/1 chair per carton/18.7 cubic feet
- Advanced Seminar chair: 40 pounds/1 chair per carton/16.0 cubic feet

### Specifications

Designed for use by individuals up to 325 lbs.

# X99

## At-A-Glance

### Catalog Logic

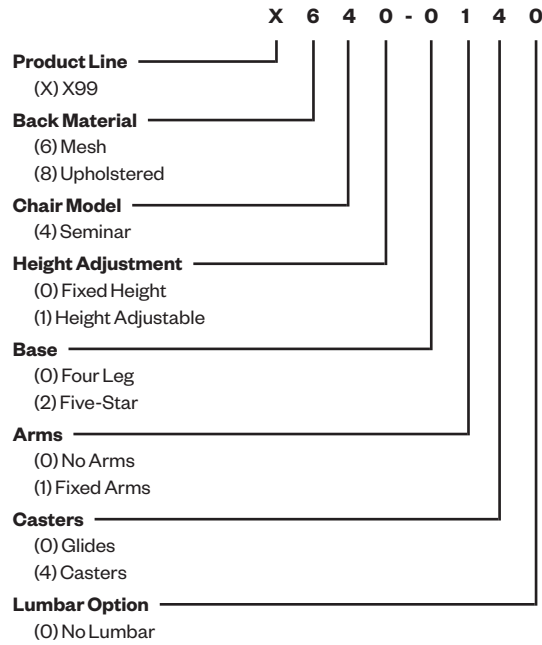

# X99

## Seminar Chair



X640-0040

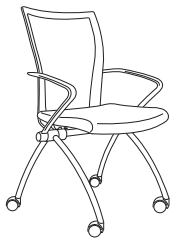

X640-0140

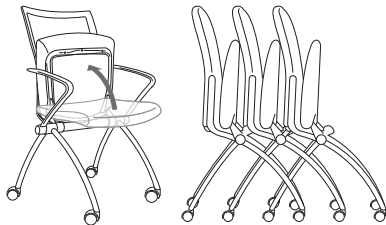

Class X99

### Features

- Back: Soft mesh or upholstered.
- Seat: Standard upholstered, with folding seat.
- Arms: Black polypropylene arm caps.
- Casters: Standard with hard casters; or optional soft casters, see below.
- Optional black glides, see below.
- Aluminum uprights with welded steel frame.
- Each nested chair adds 7.5"(191mm) of floor space.
- COM yardage / COL square footage:
  - Mesh back model: 0.5/15
  - Fully upholstered model: 1.4/25
- Casters shipped unassembled.

### Dimensions

Height:	Depth:	Width:
H: 36"(914mm)	D: 24"(610mm)	W: 22"(559mm)
*SH: 19"(483mm)	*SD: 18"(457mm)	*SW: 19"(483mm)
*AH: 8"(203mm)		

\*Measurements taken with the BIFMA chair measuring device.

### To Order, Specify:

- 1) Product number.
- 2) Fabric surface and color (seat).
- 3) Fabric or mesh surface and color (back).
- 4) Trim color for frame.  
(Add **\$552.48** for chrome finish.)

Seat	Back	Number	Fabric								Leather	
			A	B	C	D	E	F	G	H	A	B
<b>Without Arms</b>												
Upholstered	Mesh	X640-0040	\$1469.41	\$1533.39	\$1595.41	\$1628.33	\$ 1653.59	\$1709.80	\$1762.14	\$ 1905.60	\$2004.45	\$2259.62
Upholstered	Upholstered	X840-0040	1593.50	1721.46	1845.50	1911.34	1961.86	2074.28	2178.96	2465.88	2663.58	3173.92
<b>With Arms</b>												
Upholstered	Mesh	X640-0140	\$1570.23	\$1634.21	\$1696.23	\$1729.15	\$ 1754.41	\$ 1810.62	\$1862.96	\$2006.42	\$ 2105.27	\$2360.44
Upholstered	Upholstered	X840-0140	1694.32	1822.28	1946.32	2012.16	2062.68	2175.10	2279.78	2566.70	2764.40	3274.74

The following options require modification of the product number.

Soft Caster	To specify, change the 7th digit from a <b>4</b> (hard caster) to a <b>2</b> (soft caster) (add <b>\$66.96</b> list); <b>Example:</b> X640-0120
Glide	To specify, change the 7th digit from a <b>4</b> (hard caster) to a <b>0</b> ; <b>Example:</b> X640-0100
Stain Repellent	To specify, add <b>-P</b> to end of the product number (add <b>\$62.02</b> list); <b>Example:</b> X640-0140- <b>P</b>
Moisture Barrier with Stain Repellent	To specify, add <b>-D</b> to end of the product number (add <b>\$81.39</b> list); <b>Example:</b> X640-0140- <b>D</b>
Leather Seat and Mesh Back	To specify, change the 2nd digit in mesh back model to <b>5</b> ; <b>Example:</b> X540-0140
Leather Seat and Leather Back	To specify, change the 2nd digit in upholstered back model to <b>7</b> ; <b>Example:</b> X740-0140

# X99

## Advanced Seminar Chair



X641-2040



X641-2140  
Class X99

### Features

- Back: Soft mesh or upholstered.
- Seat: Standard upholstered.
- Arms: Black polypropylene arm caps.
- Base: Five-star aluminum base.
- Pneumatic seat height adjustment range 16"(406mm)-21"(533mm).
- Casters: Standard with hard casters; or optional soft casters, see below.
- Back tilts backward 21° from the upright position.
- Optional chrome finish chairs are standard with chrome base, uprights and back crossbar.
- COM yardage / COL square footage:  
Mesh back model: 0.5/15  
Fully upholstered model: 1.4/25

### Dimensions

Height:	Depth:	Width:
H: 33.5-38.5"	D: 26.5"(673mm)	W: 26.5"(673mm)
(851-978mm)	*SD: 16"(406mm)	*SW: 18.5"(470mm)
*SH: 16-21"		
(406-533mm)		
*AH: 8"(203mm)		

\*Measurements taken with the BIFMA chair measuring device.

### To Order, Specify:

- 1) Product number.
- 2) Fabric surface and color (seat).
- 3) Fabric or mesh surface and color (back).
- 4) Trim color for frame.  
(Add **\$552.48** for chrome finish.)

Seat	Back	Number	Fabric								Leather	
			A	B	C	D	E	F	G	H	A	B
<b>Without Arms</b>												
Upholstered	Mesh	X641-2040	\$ 1721.45	\$ 1785.43	\$ 1847.45	\$ 1880.37	\$ 1905.63	\$ 1961.84	\$ 2014.18	\$ 2157.64	\$ 2256.49	\$ 2511.66
Upholstered	Upholstered	X841-2040	1845.54	1973.50	2097.54	2163.38	2213.90	2326.32	2431.00	2717.92	2915.62	3425.96
<b>With Arms</b>												
Upholstered	Mesh	X641-2140	\$1820.33	\$ 1884.31	\$ 1946.33	\$ 1979.25	\$ 2004.51	\$ 2060.72	\$ 2113.06	\$ 2256.52	\$ 2355.37	\$ 2610.54
Upholstered	Upholstered	X841-2140	1944.42	2072.38	2196.42	2262.26	2312.78	2425.20	2529.88	2816.80	3014.50	3524.84

The following options require modification of the product number.

- Soft Caster To specify, change the 7th digit from a **4** (hard caster) to a **2** (soft caster) (add **\$66.96** list); **Example:** X641-2120
- Moisture Barrier with Stain Repellent To specify, add **-P** to end of the product number (add **\$62.02** list); **Example:** X641-2140-P
- Leather Seat and Mesh Back To specify, change the 2nd digit in mesh back model to **5**; **Example:** X541-2140
- Leather Seat and Leather Back To specify, change the 2nd digit in upholstered back model to **7**; **Example:** X741-2140

# Maari

## At-A-Glance

---

### Designer

Patricia Urquiola

---

### Maari

The Maari family of seating offers numerous functional combinations in one, broad chair line to specify in almost any setting. The statement of line is rooted in a one-piece, textured, molded shell that is the same for all chairs for simplicity of specification.

---

### Awards

2018 Interior Design Best of Year winner.

---

### Features and Options

- High-strength polymer shell can be retrofitted from one base to another including from chair to stool.
- Available in standard seat height, counter height and bar height.
- Optional upholstered seat pad or seat and back pad option available.
- Options include:
  - Sled Base Chair and Stools
    - Chair and Stools available with plastic or felt glides.
    - Chair available arm or armless. Stool available as armless only.
    - Chairs stack 5 high on the floor and 8 high upholstered or 16 high non-upholstered on the Very wire stacker cart.
  - Four-Leg Chair and Stools
    - Chair and Stools available with plastic or felt glides. Chair also available with hard or soft casters.
    - Chair and Stools available arm or armless.
    - Chairs stack 5 high on the floor.
  - Wood-Leg Chair and Stools
    - Chair and Stools available with plastic or felt glides.
    - Chair and Stools available as armless only.
    - Wood-Leg chair does not stack.
  - Four-Star Base Chair
    - Fixed height chair. Stool not available.
    - Available with plastic or felt glides.
    - Seat swivels 360°.
  - Five-Star Base Chair
    - Height adjustable chair. Stool not available.
    - Available with hard or soft casters.
    - Available arm or armless.
    - Tablet arm option available in painted MDF, High-Pressure Laminate (HPL) or Wood.

---

### Specifications

Designed for use by individuals up to 325 lbs.

# Maari

## At-A-Glance

### Catalog Logic

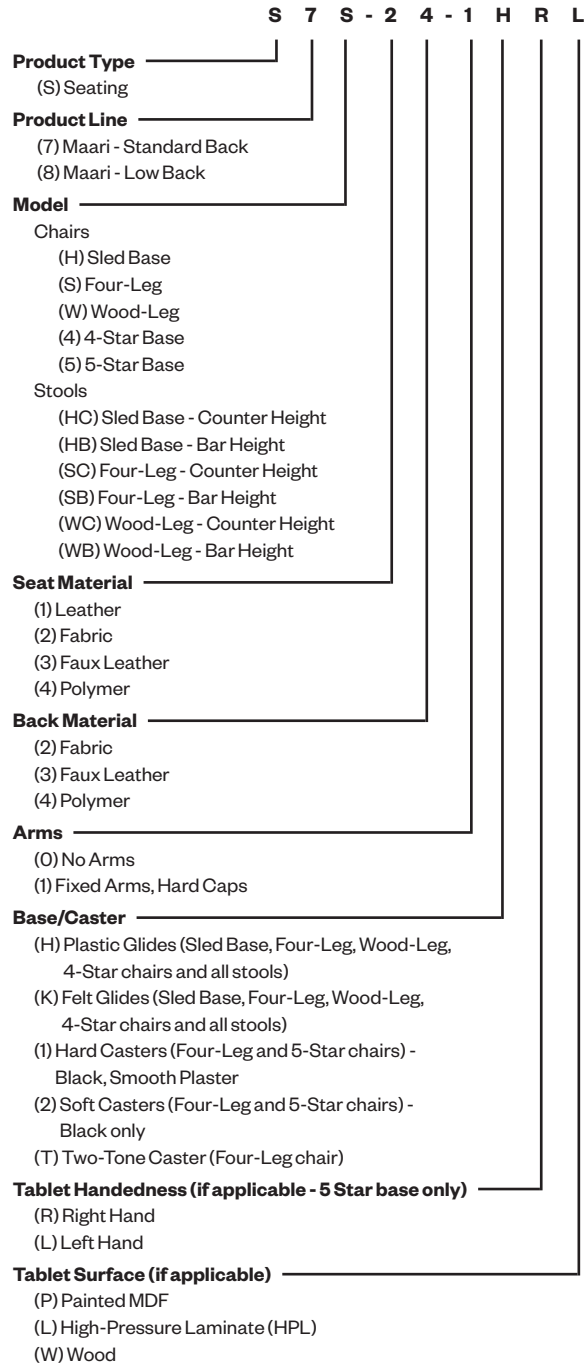

# Maari

## Sled Base Chair



S7H-44-0H



S7H-24-1H



S7H-22-1H  
Class MR

### Features

- Seat: High-strength polymer shell with optional upholstered seat pad.
- Back: High-strength polymer shell with optional upholstered back pad.
- Back not available in leather.
- Base: Available painted or chrome.
- Arm caps: Polypropylene.
- Glides: Plastic or felt.
- Stacks 5 high on the floor and 8 high upholstered or 16 high non-upholstered on the Very wire stacker cart.
- COM yardage / COL square footage:  
Seat: 0.75/6.75  
Back: 0.75/6.75

### Specification Tip

- To stack on cart, use Very wire stacker cart.

### Dimensions

Height: H: 33.75"(857mm)      Depth: D: 21.75"(552mm)      Width: W: 25.25"(641mm)  
 \*SH: 18"(457mm)      \*SD: 16.75"(425mm)      \*SW: 18.5"(470mm)  
 \*AH: 8.5"(216mm)  
 Between Arms: 22"(559mm)

\*Measurements taken with the BIFMA chair measuring device.

### To Order, Specify:

1) Product number, including:

#### 1 Seat Surface:

- 1 Leather
- 2 Fabric
- 3 Faux Leather
- 4 Polymer

#### 2 Back Surface:

- 2 Fabric
- 3 Faux Leather
- 4 Polymer

#### 3 Glide Option:

- H Plastic Glides
- K Felt Glides

- 2) Shell color (required for upholstered and non-upholstered).
- 3) Seat upholstery and color (if applicable).
- 4) Back upholstery and color (if applicable).
- 5) Base trim color.  
(Add **\$90.67** list for Smooth Plaster & Matte finish).
- 6) Trim color for arm caps (if applicable).

Number ①②③	Price	Fabric								Leather		
		A	B	C	D	E	F	G	H	A	B	
<b>Without Arms</b>												
<b>Without Optional Upholstered Pad</b>												
S7H-44-0	\$493.24	N/A	N/A	N/A	N/A	N/A	N/A	N/A	N/A	N/A	N/A	N/A
<b>With Upholstered Seat Pad</b>												
S7H-4-0	N/A	\$675.34	\$ 701.14	\$ 713.29	\$ 740.61	\$ 758.84	\$ 842.31	\$ 895.42	\$ 981.93	\$ 851.38	\$1071.47	
<b>With Upholstered Seat and Back Pad</b>												
S7H--0	N/A	\$ 857.44	\$ 909.04	\$ 933.34	\$ 987.98	\$1024.44	\$ 1191.38	\$ 1297.60	\$1470.62	N/A	N/A	
<b>With Arms</b>												
<b>Without Optional Upholstered Pad</b>												
S7H-44-1	\$ 591.89	N/A	N/A	N/A	N/A	N/A	N/A	N/A	N/A	N/A	N/A	N/A
<b>With Upholstered Seat Pad</b>												
S7H-4-1	N/A	\$ 773.99	\$ 799.79	\$ 811.94	\$ 839.26	\$ 857.49	\$ 940.96	\$ 994.07	\$1080.58	\$ 950.03	\$1170.12	
<b>With Upholstered Seat and Back Pad</b>												
S7H--1	N/A	\$ 956.09	\$1007.69	\$1031.99	\$1086.63	\$ 1123.09	\$ 1290.03	\$ 1396.25	\$1569.27	N/A	N/A	

The following options require modification of the product number.

Stain repellent

To specify, add **P** to the end of the product number (add **\$61.56** list); **Example:** S7H-24-1HP

**NOTE:** Stain repellent is available on fabric surfaces only.

# Maari

## Four-Leg Chair



S7S-44-0H



S7S-24-11



S7S-22-11  
Class MR

### Features

- Seat: High-strength polymer shell with optional upholstered seat pad.
- Back: High-strength polymer shell with optional upholstered back pad.
- Back not available in leather.
- Arm caps: Polypropylene.
- Base: Four-Leg base available with glides or casters.
- Glides: Plastic or felt.
- Casters: Hard casters available in Black or Smooth Plaster. Color received is determined by frame color. Soft casters available in Black only. Exception: Specified Two-Tone casters in Fog.
- Stacks 5 high on the floor.
- COM yardage / COL square footage:  
Seat: 0.75/6.75  
Back: 0.75/6.75

### Dimensions

Height:	Depth:	Width:
H: 33"(838mm)	D: 21.5"(546mm)	W: 25.5"(648mm)
*SH: 18"(457mm)	*SD: 16.75"(425mm)	*SW: 18.5"(470mm)
*AH: 8.5"(216mm)		
Between Arms: 21.8"(554mm)		

\*Measurements taken with the BIFMA chair measuring device.

### To Order, Specify:

1) Product number, including:

**1 Seat Surface:**

- 1** Leather
- 2** Fabric
- 3** Faux Leather
- 4** Polymer

**2 Back Surface:**

- 2** Fabric
- 3** Faux Leather
- 4** Polymer

**3 Glide or Caster Option:**

- H** Plastic Glides
- K** Felt Glides
- 1** Hard Casters (add **\$61.56** list)
- 2** Soft Casters (add **\$130.79** list)
- T** Two-Tone Casters (add **\$61.56** list)

- 2) Shell color (required for upholstered and non-upholstered).
- 3) Seat upholstery and color (if applicable).
- 4) Back upholstery and color (if applicable).
- 5) Base trim color. (Add **\$90.67** list for Smooth Plaster & Matte finish).
- 6) Trim color for arm caps (if applicable).

Number ①②③	Price	Fabric								Leather		
		A	B	C	D	E	F	G	H	A	B	
<b>Without Arms</b>												
<b>Without Optional Upholstered Pad</b>												
S7S-44-0	\$508.41	N/A	N/A	N/A	N/A	N/A	N/A	N/A	N/A	N/A	N/A	N/A
<b>With Upholstered Seat Pad</b>												
S7S-4-0	N/A	\$690.51	\$ 716.31	\$ 728.46	\$ 755.78	\$ 774.01	\$ 857.48	\$ 910.59	\$ 997.10	\$866.55	\$1086.64	
<b>With Upholstered Seat and Back Pad</b>												
S7S- -0	N/A	\$ 872.61	\$ 924.21	\$ 948.51	\$1003.15	\$1039.61	\$1206.55	\$ 1312.77	\$1485.79	N/A	N/A	
<b>With Arms</b>												
<b>Without Optional Upholstered Pad</b>												
S7S-44-1	\$ 607.06	N/A	N/A	N/A	N/A	N/A	N/A	N/A	N/A	N/A	N/A	
<b>With Upholstered Seat Pad</b>												
S7S-4-1	N/A	\$ 789.16	\$ 814.96	\$ 827.11	\$ 854.43	\$ 872.66	\$ 956.13	\$1009.24	\$1095.75	\$965.20	\$ 1185.29	
<b>With Upholstered Seat and Back Pad</b>												
S7S- -1	N/A	\$ 971.26	\$1022.86	\$1047.16	\$ 1101.80	\$ 1138.26	\$1305.20	\$ 1411.42	\$1584.44	N/A	N/A	

The following options require modification of the product number.

Stain repellent

To specify, add **P** to the end of the product number (add **\$61.56** list); **Example:** S7S-24-1HP

**NOTE:** Stain repellent is available on fabric surfaces only.

# Maari

## Wood-Leg Chair



S7W-44-OH



S7W-24-OH



S7W-22-OH  
Class MR

### Features

- Seat: High-strength polymer shell with optional upholstered seat pad.
- Back: High-strength polymer shell with optional upholstered back pad.
- Back not available in leather.
- Base: Four leg wooden base.
- Glides: Plastic or felt.
- Chair only available without arms.
- Wood-Leg Chair does not stack.
- COM yardage / COL square footage:  
Seat: 0.75/6.75  
Back: 0.75/6.75

### Dimensions

Height:                      Depth:                      Width:  
H: 34"(864mm)              D: 21.5"(546mm)              W: 19.5"(495mm)  
\*SH: 18"(457mm)              \*SD: 16.75"(425mm)              \*SW: 18.5"(470mm)

\*Measurements taken with the BIFMA chair measuring device.

### To Order, Specify:

1) Product number, including:

#### 1 Seat Surface:

- 1 Leather
- 2 Fabric
- 3 Faux Leather
- 4 Polymer

#### 2 Back Surface:

- 2 Fabric
- 3 Faux Leather
- 4 Polymer

#### 3 Glide Option:

- H Plastic Glides
- K Felt Glides

- 2) Shell color (required for upholstered and non-upholstered).
- 3) Seat upholstery and color (if applicable).
- 4) Back upholstery and color (if applicable).
- 5) Wood finish.

Number ①②③	Price	Fabric								Leather		
		A	B	C	D	E	F	G	H	A	B	
<b>Without Optional Upholstered Pad</b>												
S7W-44-0	\$1175.06	N/A	N/A	N/A	N/A	N/A	N/A	N/A	N/A	N/A	N/A	N/A
<b>With Upholstered Seat Pad</b>												
S7W-4-0	N/A	\$1357.16	\$1382.96	\$1395.11	\$1422.43	\$1440.66	\$1524.13	\$1577.24	\$1663.75	\$1533.20	\$1753.29	
<b>With Upholstered Seat and Back Pad</b>												
S7W-0-0	N/A	\$1539.26	\$1590.86	\$1615.16	\$1669.80	\$1706.26	\$1873.20	\$1979.42	\$2152.44	N/A	N/A	

The following options require modification of the product number.

Stain repellent

To specify, add **P** to the end of the product number (add **\$61.56** list); **Example:** S7W-24-OHP

**NOTE:** Stain repellent is available on fabric surfaces only.

# Maari

## Four-Star Base Chair



S74-44-0H



S74-24-1H



S74-22-1H  
Class MR

### Features

- Seat: High-strength polymer shell with optional upholstered seat pad.
- Back: High-strength polymer shell with optional upholstered back pad.
- Back not available in leather.
- Arm caps: Polypropylene.
- Base: Fixed height four-star base with glides.
- Glides: Plastic or felt.
- Seat swivels 360°.
- COM yardage / COL square footage:  
Seat: 0.75/6.75  
Back: 0.75/6.75

### Dimensions

Height: H: 34"(864mm)      Depth: D: 25.5"(648mm)      Width: W: 25.5"(648mm)  
 \*SH: 18"(457mm)      \*SD: 16.75"(425mm)      \*SW: 18.5"(470mm)  
 \*AH: 8.5"(216mm)  
 Between Arms: 21.5"(546mm)

\*Measurements taken with the BIFMA chair measuring device.

### To Order, Specify:

1) Product number, including:

#### 1 Seat Surface:

- 1 Leather
- 2 Fabric
- 3 Faux Leather
- 4 Polymer

#### 2 Back Surface:

- 2 Fabric
- 3 Faux Leather
- 4 Polymer

#### 3 Glide Option:

- H Plastic Glides
- K Felt Glides

- 2) Shell color (required for upholstered and non-upholstered).
- 3) Seat upholstery and color (if applicable).
- 4) Back upholstery and color (if applicable).
- 5) Base trim color.  
(Add **\$90.67** list for Smooth Plaster & Matte finish).
- 6) Trim color for arm caps (if applicable).

Number ①②③	Price	Fabric									Leather			
		A	B	C	D	E	F	G	H	A	B			
<b>Without Arms</b>														
<b>Without Optional Upholstered Pad</b>														
S74-44-0	\$867.14	N/A	N/A	N/A	N/A	N/A	N/A	N/A	N/A	N/A	N/A	N/A	N/A	
<b>With Upholstered Seat Pad</b>														
S74-4-0	N/A	\$1049.24	\$1075.04	\$1087.19	\$1114.51	\$1132.74	\$1216.21	\$1269.32	\$1355.83	\$1225.28	\$1445.37			
<b>With Upholstered Seat and Back Pad</b>														
S74-0	N/A	\$1231.34	\$1282.94	\$1307.24	\$1361.88	\$1398.34	\$1565.28	\$1671.50	\$1844.52	N/A	N/A			
<b>With Arms</b>														
<b>Without Optional Upholstered Pad</b>														
S74-44-1	\$965.79	N/A	N/A	N/A	N/A	N/A	N/A	N/A	N/A	N/A	N/A	N/A	N/A	
<b>With Upholstered Seat Pad</b>														
S74-4-1	N/A	\$1147.89	\$1173.69	\$1185.84	\$1213.16	\$1231.39	\$1314.86	\$1367.97	\$1454.48	\$1323.93	\$1544.02			
<b>With Upholstered Seat and Back Pad</b>														
S74-1	N/A	\$1329.99	\$1381.59	\$1405.89	\$1460.53	\$1496.99	\$1663.93	\$1770.15	\$1943.17	N/A	N/A			

The following options require modification of the product number.

Stain repellent

To specify, add **P** to the end of the product number (add **\$61.56** list); **Example:** S74-24-1HP

**NOTE:** Stain repellent is available on fabric surfaces only.

# Maari

## Five-Star Base Chair



S75-44-01



S75-24-11



S75-22-11  
Class MR

### Features

- Seat: High-strength polymer shell with optional upholstered seat pad.
- Back: High-strength polymer shell with optional upholstered back pad.
- Back not available in leather.
- Base: Five-star height adjustable base with casters.
- Height adjustment range: 16"(406mm)-21"(533mm)
- Arm caps: Polypropylene.
- Casters: Hard casters will be color matched to the base. Soft casters available in Black only.
- Tablet option:
  - Tablet arm available right or left handed.
  - Dual-pivot tablet rotates 360° at both the arm's pivot joint and tablet surface connection point.
  - Tablet surface is 11.5"(292mm)D x 19"(483mm)W and 0.75"(19mm) thick.
  - Tablet surface available in painted MDF, high-pressure laminate (HPL) and wood in White Oak or Walnut.
- COM yardage / COL square footage:
  - Seat: 0.75/6.75
  - Back: 0.75/6.75

### Specification Tips

- Tablet arm handedness can be changed in the field; however, tablet option cannot be added or removed in the field.
- Pivot arm/tablet will need to be field installed to the support arm.

### Dimensions

Height:	Depth:	Width:
H: 32"(813mm)	D: 28.5"(724mm)	W: 28.5"(724mm)
*SH: 16-21" (406-533mm)	*SD: 16.75"(425mm)	*SW: 18.5"(470mm)
*AH: 8.5"(216mm)		
Between Arms: 22"(559mm)		

\*Measurements taken with the BIFMA chair measuring device.

### To Order, Specify:

1) Product number, including:

#### 1 Seat Surface:

- 1 Leather
- 2 Fabric
- 3 Faux Leather
- 4 Polymer

#### 2 Back Surface:

- 2 Fabric
- 3 Faux Leather
- 4 Polymer

#### 3 Caster Option:

- 1 Hard Casters
- 2 Soft Casters  
(add \$69.24 list)

#### 4 Tablet Option (if applicable):

- R Right Hand
- L Left Hand

2) Shell color (required for upholstered and non-upholstered).

3) Seat upholstery and color (if applicable).

4) Back upholstery and color (if applicable).

5) Base trim color.  
(Add \$90.67 list for Smooth Plaster & Matte finish).

6) Trim color for arm caps.

7) Tablet surface color (if applicable).

8) Tablet arm trim color (if applicable).

- TR-F Black
- TR-M1 Black Matte
- TR-PLS Smooth Plaster
- TR-M2 Smooth Plaster Matte

# Maari

## Five-Star Base Chair

Tablet Description	Number ①②③④	Price	Fabric								Leather	
			A	B	C	D	E	F	G	H	A	B
<b>Without Arms</b>												
<b>Polymer Shell Without Optional Upholstered Pad</b>												
No Tablet	S75-44-0	\$ 849.88	N/A	N/A	N/A	N/A	N/A	N/A	N/A	N/A	N/A	N/A
Painted MDF	S75-44-0 P	1619.56	N/A	N/A	N/A	N/A	N/A	N/A	N/A	N/A	N/A	N/A
HPL - Grade A	S75-44-0 L	1769.41	N/A	N/A	N/A	N/A	N/A	N/A	N/A	N/A	N/A	N/A
HPL - Grade B	S75-44-0 L	1787.11	N/A	N/A	N/A	N/A	N/A	N/A	N/A	N/A	N/A	N/A
Wood - White Oak	S75-44-0 W	2668.49	N/A	N/A	N/A	N/A	N/A	N/A	N/A	N/A	N/A	N/A
Wood - Walnut	S75-44-0 W	2743.43	N/A	N/A	N/A	N/A	N/A	N/A	N/A	N/A	N/A	N/A
<b>Polymer Shell With Upholstered Seat Pad</b>												
No Tablet	S75-4-0	N/A	\$ 1031.98	\$ 1057.78	\$ 1069.93	\$ 1097.25	\$ 1115.48	\$ 1198.95	\$ 1252.06	\$ 1338.57	\$ 1208.02	\$ 1428.11
Painted MDF	S75-4-0 P	N/A	1801.66	1827.46	1839.61	1866.93	1885.16	1968.63	2021.74	2108.25	1977.70	2197.79
HPL - Grade A	S75-4-0 L	N/A	1951.51	1977.31	1989.46	2016.78	2035.01	2118.48	2171.59	2258.10	2127.55	2347.64
HPL - Grade B	S75-4-0 L	N/A	1969.21	1995.01	2007.16	2034.48	2052.71	2136.18	2189.29	2275.80	2145.25	2365.34
Wood - White Oak	S75-4-0 W	N/A	2850.59	2876.39	2888.54	2915.86	2934.09	3017.56	3070.67	3157.18	3026.63	3246.72
Wood - Walnut	S75-4-0 W	N/A	2925.53	2951.33	2963.48	2990.80	3009.03	3092.50	3145.61	3232.12	3101.57	3321.66
<b>Polymer Shell With Upholstered Seat and Back Pads</b>												
No Tablet	S75--0	N/A	\$ 1214.08	\$ 1265.68	\$ 1289.98	\$ 1344.62	\$ 1381.08	\$ 1548.02	\$ 1654.24	\$ 1827.26	N/A	N/A
Painted MDF	S75--0 P	N/A	1983.76	2035.36	2059.66	2114.30	2150.76	2317.70	2423.92	2596.94	N/A	N/A
HPL - Grade A	S75--0 L	N/A	2133.61	2185.21	2209.51	2264.15	2300.61	2467.55	2573.77	2746.79	N/A	N/A
HPL - Grade B	S75--0 L	N/A	2151.31	2202.91	2227.21	2281.85	2318.31	2485.25	2591.47	2764.49	N/A	N/A
Wood - White Oak	S75--0 W	N/A	3032.69	3084.29	3108.59	3163.23	3199.69	3366.63	3472.85	3645.87	N/A	N/A
Wood - Walnut	S75--0 W	N/A	3107.63	3159.23	3183.53	3238.17	3274.63	3441.57	3547.79	3720.81	N/A	N/A
<b>With Arms</b>												
<b>Polymer Shell Without Optional Upholstered Pad</b>												
No Tablet	S75-44-1	\$ 948.53	N/A	N/A	N/A	N/A	N/A	N/A	N/A	N/A	N/A	N/A
Painted MDF	S75-44-1 P	1718.21	N/A	N/A	N/A	N/A	N/A	N/A	N/A	N/A	N/A	N/A
HPL - Grade A	S75-44-1 L	1868.06	N/A	N/A	N/A	N/A	N/A	N/A	N/A	N/A	N/A	N/A
HPL - Grade B	S75-44-1 L	1885.76	N/A	N/A	N/A	N/A	N/A	N/A	N/A	N/A	N/A	N/A
Wood - White Oak	S75-44-1 W	2767.14	N/A	N/A	N/A	N/A	N/A	N/A	N/A	N/A	N/A	N/A
Wood - Walnut	S75-44-1 W	2842.08	N/A	N/A	N/A	N/A	N/A	N/A	N/A	N/A	N/A	N/A
<b>Polymer Shell With Upholstered Seat Pad</b>												
No Tablet	S75-4-1	N/A	\$ 1130.63	\$ 1156.43	\$ 1168.58	\$ 1195.90	\$ 1214.13	\$ 1297.60	\$ 1350.71	\$ 1437.22	\$ 1306.67	\$ 1526.76
Painted MDF	S75-4-1 P	N/A	1900.31	1926.11	1938.26	1965.58	1983.81	2067.28	2120.39	2206.90	2076.35	2296.44
HPL - Grade A	S75-4-1 L	N/A	2050.16	2075.96	2088.11	2115.43	2133.66	2217.13	2270.24	2356.75	2226.20	2446.29
HPL - Grade B	S75-4-1 L	N/A	2067.86	2093.66	2105.81	2133.13	2151.36	2234.83	2287.94	2374.45	2243.90	2463.99
Wood - White Oak	S75-4-1 W	N/A	2949.24	2975.04	2987.19	3014.51	3032.74	3116.21	3169.32	3255.83	3125.28	3345.37
Wood - Walnut	S75-4-1 W	N/A	3024.18	3049.98	3062.13	3089.45	3107.68	3191.15	3244.26	3330.77	3200.22	3420.31
<b>Polymer Shell With Upholstered Seat and Back Pads</b>												
No Tablet	S75--1	N/A	\$ 1312.73	\$ 1364.33	\$ 1388.63	\$ 1443.27	\$ 1479.73	\$ 1646.67	\$ 1752.89	\$ 1925.91	N/A	N/A
Painted MDF	S75--1 P	N/A	2082.41	2134.01	2158.31	2212.95	2249.41	2416.35	2522.57	2695.59	N/A	N/A
HPL - Grade A	S75--1 L	N/A	2232.26	2283.86	2308.16	2362.80	2399.26	2566.20	2672.42	2845.44	N/A	N/A
HPL - Grade B	S75--1 L	N/A	2249.96	2301.56	2325.86	2380.50	2416.96	2583.90	2690.12	2863.14	N/A	N/A
Wood - White Oak	S75--1 W	N/A	3131.34	3182.94	3207.24	3261.88	3298.34	3465.28	3571.50	3744.52	N/A	N/A
Wood - Walnut	S75--1 W	N/A	3206.28	3257.88	3282.18	3336.82	3373.28	3540.22	3646.44	3819.46	N/A	N/A

# Maari

## Sled Base Stool

### Standard Back

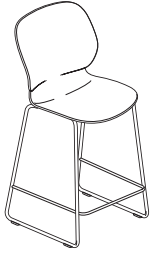

S7HB-44-0H  
S7HC-44-0H



S7HB-24-0H  
S7HC-24-0H



S7HB-22-0H  
S7HC-22-0H  
Class MR

#### Features

- Seat: High-strength polymer shell with optional upholstered seat pad.
- Back: High-strength polymer shell with optional upholstered back pad.
- Back not available in leather.
- Base: Sled base available in bar height or counter height.
- Glides: Plastic or felt.
- Available without arms only.
- COM yardage / COL square footage:  
Seat: 0.75/6.75  
Back: 0.75/6.75

#### Dimensions

Height:	Depth:	Width:
H: 45.5"(1156mm)	D: 23"(584mm)	W: 23"(584mm)
Bar Height	*SD: 16.75"(425mm)	*SW: 18.5"(470mm)
41.5"(1054mm)		
Counter Height		
*SH: 30"(762mm)		
Bar Height		
26"(660mm)		
Counter Height		

\*Measurements taken with the BIFMA chair measuring device.

#### To Order, Specify:

1) Product number, including:

##### 1 Seat Surface:

- 1 Leather
- 2 Fabric
- 3 Faux Leather
- 4 Polymer

##### 2 Back Surface:

- 2 Fabric
- 3 Faux Leather
- 4 Polymer

##### 3 Glide Option:

- H Plastic Glides
- K Felt Glides

- 2) Shell color (required for upholstered and non-upholstered).
- 3) Seat upholstery and color (if applicable).
- 4) Back upholstery and color (if applicable).
- 5) Base trim color.  
(Add **\$90.67** list for Smooth Plaster & Matte finish).

Description	Number ①②③	Price	Fabric							Leather		
			A	B	C	D	E	F	G	H	A	B
<b>Without Optional Upholstered Pad</b>												
Bar Height	S7HB-44-0	\$799.70	N/A	N/A	N/A	N/A	N/A	N/A	N/A	N/A	N/A	N/A
Counter Height	S7HC-44-0	761.85	N/A	N/A	N/A	N/A	N/A	N/A	N/A	N/A	N/A	N/A
<b>With Upholstered Seat Pad</b>												
Bar Height	S7HB- 4-0	N/A	\$ 981.80	\$1007.60	\$ 1019.75	\$ 1047.07	\$1065.30	\$ 1148.77	\$ 1201.88	\$1288.39	\$1157.84	\$ 1377.93
Counter Height	S7HC- 4-0	N/A	943.95	969.75	981.90	1009.22	1027.45	1110.92	1164.03	1250.54	1119.99	1340.08
<b>With Upholstered Seat and Back Pad</b>												
Bar Height	S7HB- -0	N/A	\$1163.90	\$ 1215.50	\$1239.80	\$1294.44	\$1330.90	\$1497.84	\$1604.06	\$ 1777.08	N/A	N/A
Counter Height	S7HC- -0	N/A	1126.05	1177.65	1201.95	1256.59	1293.05	1459.99	1566.21	1739.23	N/A	N/A

The following options require modification of the product number.

Stain repellent

To specify, add **P** to the end of the product number (add **\$61.56** list); **Example:** S7HB-24-0HP

**NOTE:** Stain repellent is available on fabric surfaces only.

# Maari

## Sled Base Stool

### Low Back

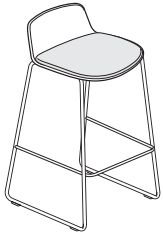

S8HB-24-OH  
S8HC-24-OH  
Class MR

#### Features

- Seat: High-strength polymer shell with or without upholstered seat pad.
- Back: High-strength low back polymer shell.
- Base: Available in bar height or counter height.
- Glides: Plastic or felt.
- Available without arms only.
- COM yardage / COL square footage:  
Seat: 0.75/6.75

#### Dimensions

Height:	Depth:	Width:
H: 35.25"(895mm)	D: 23"(584mm)	W: 23"(584mm)
Bar Height	*SD: 16.75"(425mm)	*SW: 18.5"(470mm)
31.25"(794mm)		
Counter Height		
*SH: 30"(762mm)		
Bar Height		
26"(660mm)		
Counter Height		

\*Measurements taken with the BIFMA chair measuring device.

#### To Order, Specify:

1) Product number, including:

##### 1 Seat Surface:

- 1 Leather
- 2 Fabric
- 3 Faux Leather
- 4 Polymer

##### 2 Glide Option:

- H Plastic Glides
- K Felt Glides

2) Shell color.

3) Seat upholstery and color (if applicable).

4) Base trim color.  
(Add **\$90.67** list for Smooth Plaster & Matte finish).

Description	Number ①②③	Price	Fabric								Leather		
			A	B	C	D	E	F	G	H	A	B	
<b>Without Upholstered Seat Pad</b>													
Bar Height	S8HB-44-0	\$ 761.77	N/A	N/A	N/A	N/A	N/A	N/A	N/A	N/A	N/A	N/A	N/A
Counter Height	S8HC-44-0	723.92	N/A	N/A	N/A	N/A	N/A	N/A	N/A	N/A	N/A	N/A	N/A
<b>With Upholstered Seat Pad</b>													
Bar Height	S8HB-4-0	N/A	\$943.87	\$969.67	\$ 981.82	\$1009.14	\$1027.37	\$ 1110.84	\$1163.95	\$1250.46	\$ 1119.91	\$1340.00	
Counter Height	S8HC-4-0	N/A	906.02	931.82	943.97	971.29	989.52	1072.99	1126.10	1212.61	1082.06	1302.15	

The following options require modification of the product number.

Stain repellent

To specify, add **P** to the end of the product number (add **\$61.56** list); **Example:** S8HB-24-OHP

**NOTE:** Stain repellent is available on fabric surfaces only.

# Maari

## Four-Leg Stool

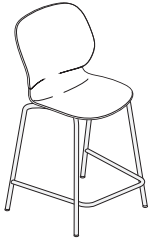

S7SB-44-0H  
S7SC-44-0H



S7SB-24-1H  
S7SC-24-1H

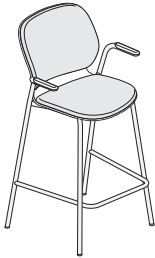

S7SB-22-1H  
S7SC-22-1H  
Class MR

### Features

- Seat: High-strength polymer shell with optional upholstered seat pad.
- Back: High-strength polymer shell with optional upholstered back pad.
- Back not available in leather.
- Arm caps: Polypropylene.
- Base: Four-Leg available in bar height or counter height.
- Glides: Plastic or felt.
- COM yardage / COL square footage:  
Seat: 0.75/6.75  
Back: 0.75/6.75

### Dimensions

- |                  |                    |                   |
|------------------|--------------------|-------------------|
| Height:          | Depth:             | Width:            |
| H: 45.5"(1156mm) | D: 23"(584mm)      | W: 23"(584mm)     |
| Bar Height       | *SD: 16.75"(425mm) | *SW: 18.5"(470mm) |
| 41.5"(1054mm)    |                    |                   |
| Counter Height   |                    |                   |
| *SH: 30"(762mm)  |                    |                   |
| Bar Height       |                    |                   |
| 26"(660mm)       |                    |                   |
| Counter Height   |                    |                   |
| *AH: 8.5"(216mm) |                    |                   |
- \*Measurements taken with the BIFMA chair measuring device.*

### To Order, Specify:

1) Product number, including:

#### 1 Seat Surface:

- 1 Leather
- 2 Fabric
- 3 Faux Leather
- 4 Polymer

#### 2 Back Surface:

- 2 Fabric
- 3 Faux Leather
- 4 Polymer

#### 3 Glide Option:

- H Plastic Glides
- K Felt Glides

2) Shell color (required for upholstered and non-upholstered).

3) Seat upholstery and color (if applicable).

4) Back upholstery and color (if applicable).

5) Base trim color.  
(Add **\$90.67** list for Smooth Plaster & Matte finish).

6) Color for arm caps (if applicable).

Description	Number	Price	Fabric								Leather	
			A	B	C	D	E	F	G	H	A	B
<b>Without Arms</b>												
<b>Without Optional Upholstered Pad</b>												
Bar Height	S7SB-44-0	\$ 910.49	N/A	N/A	N/A	N/A	N/A	N/A	N/A	N/A	N/A	N/A
Counter Height	S7SC-44-0	872.64	N/A	N/A	N/A	N/A	N/A	N/A	N/A	N/A	N/A	N/A
<b>With Upholstered Seat Pad</b>												
Bar Height	S7SB-4-0	N/A	\$1092.59	\$ 1118.39	\$ 1130.54	\$ 1157.86	\$ 1176.09	\$1259.56	\$ 1312.67	\$1399.18	\$1268.63	\$1488.72
Counter Height	S7SC-4-0	N/A	1054.74	1080.54	1092.69	1120.01	1138.24	1221.71	1274.82	1361.33	1230.78	1450.87
<b>With Upholstered Seat and Back Pad</b>												
Bar Height	S7SB-4-0	N/A	\$ 1274.69	\$1326.29	\$1350.59	\$1405.23	\$ 1441.69	\$1608.63	\$ 1714.85	\$ 1887.87	N/A	N/A
Counter Height	S7SC-4-0	N/A	1236.84	1288.44	1312.74	1367.38	1403.84	1570.78	1677.00	1850.02	N/A	N/A
<b>With Arms</b>												
<b>Without Optional Upholstered Pad</b>												
Bar Height	S7SB-44-1	\$1009.14	N/A	N/A	N/A	N/A	N/A	N/A	N/A	N/A	N/A	N/A
Counter Height	S7SC-44-1	971.29	N/A	N/A	N/A	N/A	N/A	N/A	N/A	N/A	N/A	N/A
<b>With Upholstered Seat Pad</b>												
Bar Height	S7SB-4-1	N/A	\$ 1191.24	\$ 1217.04	\$1229.19	\$1256.51	\$ 1274.74	\$ 1358.21	\$ 1411.32	\$ 1497.83	\$1367.28	\$ 1587.37
Counter Height	S7SC-4-1	N/A	1153.39	1179.19	1191.34	1218.66	1236.89	1320.36	1373.47	1459.98	1329.43	1549.52
<b>With Upholstered Seat and Back Pad</b>												
Bar Height	S7SB-4-1	N/A	\$ 1373.34	\$1424.94	\$1449.24	\$1503.88	\$1540.34	\$ 1707.28	\$ 1813.50	\$1986.52	N/A	N/A
Counter Height	S7SC-4-1	N/A	1335.49	1387.09	1411.39	1466.03	1502.49	1669.43	1775.65	1948.67	N/A	N/A

The following options require modification of the product number.

Stain repellent

To specify, add **P** to the end of the product number (add **\$61.56** list); **Example:** S7SB-24-1HP

**NOTE:** Stain repellent is available on fabric surfaces only.

# Maari

## Wood-Leg Stool

### Standard Back



S7WB-44-0H  
S7WC-44-0H



S7WB-24-0H  
S7WC-24-0H



S7WB-22-0H  
S7WC-22-0H  
Class MR

### Features

- Seat: High-strength polymer shell with optional upholstered seat pad.
- Back: High-strength polymer shell with optional upholstered back pad.
- Back not available in leather.
- Base: Wood leg available in bar height or counter height.
- Glides: Plastic or felt.
- Available without arms only.
- Foot ring available in black or chrome.
- COM yardage / COL square footage:  
Seat: 0.75/6.75  
Back: 0.75/6.75

### Dimensions

Height:	Depth:	Width:
H: 45.5"(1156mm)	D: 23"(584mm)	W: 23"(584mm)
Bar Height	*SD: 16.75"(425mm)	*SW: 18.5"(470mm)
41.5"(1054mm)		
Counter Height		
*SH: 30"(762mm)		
Bar Height		
26"(660mm)		
Counter Height		

\*Measurements taken with the BIFMA chair measuring device.

### To Order, Specify:

1) Product number, including:

#### 1 Seat Surface:

- 1 Leather
- 2 Fabric
- 3 Faux Leather
- 4 Polymer

#### 2 Back Surface:

- 2 Fabric
- 3 Faux Leather
- 4 Polymer

#### 3 Glide Option:

- H Plastic Glides
- K Felt Glides

2) Shell color (required for upholstered and non-upholstered).

3) Seat upholstery and color (if applicable).

4) Back upholstery and color (if applicable).

5) Wood finish.

6) Foot ring finish.

TR-F Black

KR-V Chrome (add **\$149.38** list)

Description	Number ①②③	Price	Fabric								Leather	
			A	B	C	D	E	F	G	H	A	B
<b>Without Optional Upholstered Pad</b>												
Bar Height	S7WB-44-0	\$1901.73	N/A	N/A	N/A	N/A	N/A	N/A	N/A	N/A	N/A	N/A
Counter Height	S7WC-44-0	1863.88	N/A	N/A	N/A	N/A	N/A	N/A	N/A	N/A	N/A	N/A
<b>With Upholstered Seat Pad</b>												
Bar Height	S7WB- 4-0	N/A	\$2083.83	\$2109.63	\$2121.78	\$2149.10	\$2167.33	\$2250.80	\$2303.91	\$2390.42	\$2259.87	\$2479.96
Counter Height	S7WC- 4-0	N/A	2045.98	2071.78	2083.93	2111.25	2129.48	2212.95	2266.06	2352.57	2222.02	2442.11
<b>With Upholstered Seat and Back Pad</b>												
Bar Height	S7WB- -0	N/A	\$2265.93	\$2317.53	\$2341.83	\$2396.47	\$2432.93	\$2599.87	\$2706.09	\$2879.11	N/A	N/A
Counter Height	S7WC- -0	N/A	2228.08	2279.68	2303.98	2358.62	2395.08	2562.02	2668.24	2841.26	N/A	N/A

The following options require modification of the product number.

Stain repellent

To specify, add **P** to the end of the product number (add **\$61.56** list); **Example:** S7WB-24-OHP

**NOTE:** Stain repellent is available on fabric surfaces only.

# Maari

## Wood-Leg Stool

### Low Back

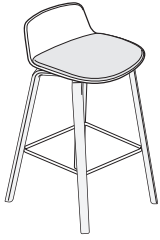

S8WB-24-OH  
S8WC-24-OH  
Class MR

#### Features

- Seat: High-strength polymer shell with upholstered seat pad.
- Back: High-strength low back polymer shell.
- Base: Available in bar height or counter height.
- Foot ring available in black or chrome.
- Glides: Plastic or felt.
- Available without arms only.
- COM yardage / COL square footage:  
Seat: 0.75/6.75

#### Dimensions

Height:	Depth:	Width:
H: 35.25"(895mm)	D: 23"(584mm)	W: 23"(584mm)
Bar Height	*SD: 16.75"(425mm)	*SW: 18.5"(470mm)
31.25"(794mm)		
Counter Height		
*SH: 30"(762mm)		
Bar Height		
26"(660mm)		
Counter Height		

\*Measurements taken with the BIFMA chair measuring device.

#### To Order, Specify:

1) Product number, including:

##### 1 Seat Surface:

- 1 Leather
- 2 Fabric
- 3 Faux Leather

##### 2 Glide Option:

- H Plastic Glides
- K Felt Glides

2) Shell color.

3) Seat upholstery and color

4) Wood finish.

5) Foot ring finish.

TR-F Black

KR-V Chrome (add **\$149.38** list)

Description	Number		Fabric								Leather	
	1	2	A	B	C	D	E	F	G	H	A	B
<b>With Upholstered Seat Pad</b>												
Bar Height	S8WB-	4-0	\$2043.31	\$2069.11	\$2081.26	\$2108.58	\$2126.81	\$2210.28	\$2263.39	\$2349.90	\$2219.35	\$2439.44
Counter Height	S8WC-	4-0	2005.46	2031.26	2043.41	2070.73	2088.96	2172.43	2225.54	2312.05	2181.50	2401.59

The following options require modification of the product number.

Stain repellent

To specify, add **P** to the end of the product number (add **\$61.56** list); **Example:** S8WB-24-OHP

**NOTE:** Stain repellent is available on fabric surfaces only.

# Candor

## Guest/Occasional Seating

### Fully Upholstered Seat and Back



SAS-22-A1A  
Class SA

#### Features

- Open arms.
- Upholstered seat and back.
- Steamed beech hardwood frame. Seat frame rails are mortise and tenoned, cross locked with dowels, reinforced with corner blocks.
- Seat is HR foam over a webbed panel.
- The upholstered back frame insert is padded with foam.
- COM yardage/COL square footage: 1.5/27.0

#### Specification Tip

- Designed for use by individuals up to 325 lbs.

#### Dimensions

Height:	Depth:	Width:
H: 32.75"(832mm)	D: 23.5"(597mm)	W: 21"(533mm)
SH: 17.8"(452mm)	SD: 17"(432mm)	SW: 17.8"(452mm)
AH: 25"(635mm)		

#### To Order, Specify:

- 1) Product number, including:

#### 1 Seat Option:

- 1 Leather
- 2 Fabric
- 3 Faux Leather

#### 2 Back Option:

- 1 Leather
- 2 Fabric
- 3 Faux Leather

- 2) Fabric surface and color (seat).
- 3) Fabric surface and color (back).
- 4) Arm/frame finish color.

Number 1 2	Fabric							Leather		
	A	B	C	D	E	F	G	H	A	B
SAS- <input type="checkbox"/> -A1A	\$1680.35	\$1725.43	\$1743.55	\$1788.59	\$1815.61	\$2126.95	\$2217.17	\$2487.77	\$2284.85	\$2823.17

### Fully Upholstered Seat and 1/2 Back



SAS-22-A3A  
Class SA

#### Features

- Open arms.
- Upholstered seat and back.
- Steamed beech hardwood frame. Seat frame rails are mortise and tenoned, cross locked with dowels, reinforced with corner blocks.
- Seat is HR foam over a webbed panel.
- The upholstered back frame insert is padded with foam.
- COM yardage/COL square footage: 1.25/22.5

#### Specification Tip

- Designed for use by individuals up to 325 lbs.

#### Dimensions

Height:	Depth:	Width:
H: 32.5"(826mm)	D: 23"(584mm)	W: 21"(533mm)
SH: 17.8"(452mm)	SD: 17"(432mm)	SW: 17.8"(452mm)
AH: 25"(635mm)		

#### To Order, Specify:

- 1) Product number, including:

#### 1 Seat Option:

- 1 Leather
- 2 Fabric
- 3 Faux Leather

#### 2 Back Option:

- 1 Leather
- 2 Fabric
- 3 Faux Leather

- 2) Fabric surface and color (seat).
- 3) Fabric surface and color (back).
- 4) Arm/frame finish color.

Number 1 2	Fabric							Leather		
	A	B	C	D	E	F	G	H	A	B
SAS- <input type="checkbox"/> -A3A	\$1680.35	\$1725.43	\$1743.55	\$1788.59	\$1815.61	\$2126.95	\$2217.17	\$2487.77	\$2284.85	\$2823.17

The following options require modification of the product number.

Stain Repellent

Moisture Barrier with Stain Repellent

To specify, add **-P** to the end of the product number (add **\$69.91** list); **Example:** SAS-22-A1A-**P**

To specify, add **-D** to the end of the product number (add **\$92.47** list); **Example:** SAS-22-A1A-**D**

**Note:** For available fabrics, refer to [surfaces.haworth.com](http://surfaces.haworth.com).

# Composites

## Guest/Occasional Seating

### Arc Arm, Upholstered Back



4045-00  
Class QA

#### Features

- Open arms.
- Upholstered seat and back.
- Maple hardwood frame. Seat frame rails are mortise and tenoned, cross locked with dowels, reinforced with corner blocks.
- Seat is HR foam over a webbed panel.
- The upholstered back frame insert is webbed and padded with foam.
- Available with fire-retardant construction to comply with California Bulletin #133.
- COM yardage/COL square footage: 1.25/22.5

#### Specification Tip

- Designed for use by individuals up to 325 lbs.

#### Dimensions

Height:	Depth:	Width:
H: 33.75"(857mm)	D: 23"(584mm)	W: 22.375"(568mm)
SH: 18.5"(470mm)	SD: 18"(457mm)	SW: 19.5"(495mm)
AH: 24-26" (610-660mm)		

#### To Order, Specify:

- 1) Product number.
- 2) Fabric surface and color.
- 3) Arm/frame finish color.

Base/Frame	Number	Fabric								Leather	
		A	B	C	D	E	F	G	H	A	B
Maple	4045-00	\$2147.16	\$2221.60	\$2289.23	\$2402.03	\$2469.68	\$2512.55	\$2591.46	\$2810.24	\$3610.95	\$3962.26

### Stool, Armless, Upholstered Back

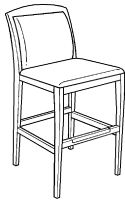

4049-00  
Class QA

#### Features

- Upholstered seat and back.
- Maple hardwood frame. Seat frame rails are mortise and tenoned, cross locked with dowels, reinforced with corner blocks.
- Seat is HR foam over a webbed panel.
- The upholstered back frame insert is webbed and padded with foam.
- Standard with brass kick plate. No finish specification required.
- Available with fire-retardant construction to comply with California Bulletin #133.
- COM yardage/COL square footage: 1.0/18.0

#### Specification Tip

- Designed for use by individuals up to 325 lbs.

#### Dimensions

Height:	Depth:	Width:
H: 41.125"(1045mm)	D: 19.875"(505mm)	W: 18.5"(470mm)
SH: 28"(711mm)	SD: 15.25"(387mm)	SW: 18.5"(470mm)

#### To Order, Specify:

- 1) Product number.
- 2) Fabric surface and color.
- 3) Frame finish color.

Base/Frame	Number	Fabric								Leather	
		A	B	C	D	E	F	G	H	A	B
Maple	4049-00	\$2147.16	\$2221.60	\$2289.23	\$2402.03	\$2469.68	\$2512.55	\$2591.46	\$2810.24	\$3610.95	\$3962.26

The following options require modification of the product number.

Stain Repellent

Moisture Barrier with Stain Repellent

To specify, add **-P** to the end of the product number (add **\$69.91** list); **Example:** 4049-00-**P**

To specify, add **-D** to the end of the product number (add **\$92.47** list); **Example:** 4049-00-**D**

**Note:** Stain repellent and moisture barrier are not available on leather or faux leather. For available fabrics, refer to [surfaces.haworth.com](http://surfaces.haworth.com).

# Resonate

## At-A-Glance

### Designer

Resonate was created through a Haworth collaboration with integrated architecture, design, planning and consulting firm Gensler serving as product design consultant. Haworth's international team of designers collaborated with research and development partners to create multi-generational products and global platforms - with regional needs and preferences in mind.

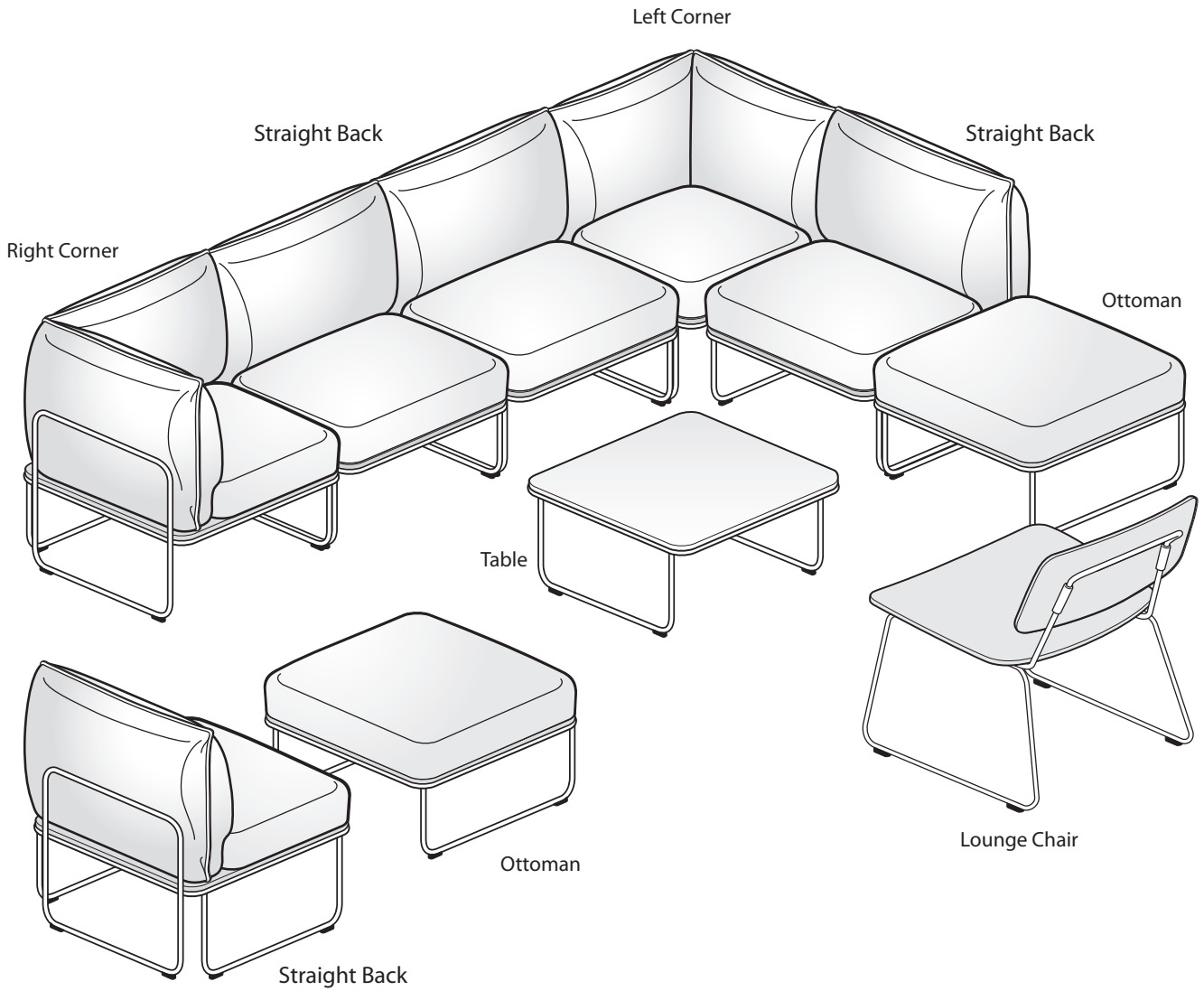

# Resonate

## At-A-Glance — General Specifications

### Environmental Factors

Refer to Product Environmental Data sheet (PED) for recycled content and certifications.  
Greenguard/Greenguard Gold Certified.

### Fabrics and Finishes

A listing of fabrics and finishes for Resonate are available in the back of the price list.  
Linear or patterned fabric is not recommended due to the manner in which fabric is applied.  
Material will not be pattern matched.  
Visit [surfaces.haworth.com](http://surfaces.haworth.com) for the most updated fabric and finish information.  
The surface collection site also has information on the Haworth alliance program with Carnegie, Luna Textiles and Maharam as well as our Pre-Approved COM program.

### Stain Repellent

To specify add "P" to the end of the product number.  
Example: SRMR-22-HP

### Specifications

Designed for use by individuals up to 325 lbs.

### Catalog Logic

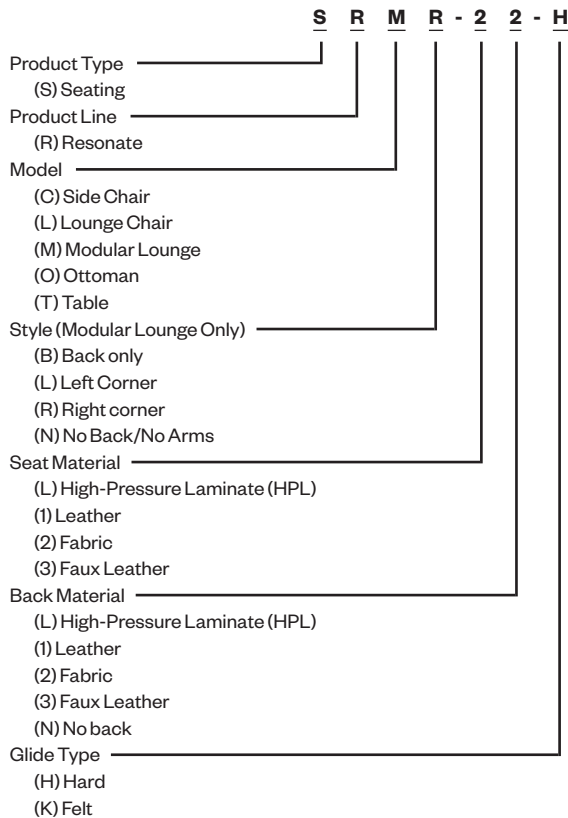

# Resonate

## At-A-Glance — General Specifications

### Corner Unit

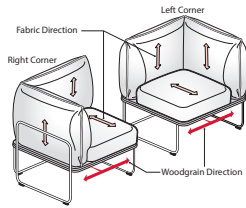

#### Features

- Corner unit available with right or left hand arm.
- Can be used as a single unit or combines with other Resonate Modular Lounge units to form a modular lounge seating area.
- Use separately specified Alignment Clips to connect components together.
- Fully upholstered Seat, Back and Arm cushions.
- Laminate platform with Natural Ply Edge edgebanding.
- Laminate available in:
  - Solid - Linen (H-WL), Putty (H-AA), Charcoal (H-8J)
  - Wood Grain - Field Elm (H- KP), Landmark (H-KM), Neo Walnut (H-KL)
- Edgeband standard in Natural Ply Edge (HP-PW)
- Painted steel frame available in:
  - Blue Jay (TR-1G)
  - Charcoal (TR-K)
  - Rusty Red (TR-RR)
  - Smooth Plaster (TR-PLS)
- Glides available in non-marring felt or hard plastic. 15" to 17.5"(38mm-44mm).

### Straight Back Unit

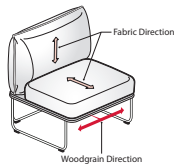

#### Features

- Straight Back Unit features a back and no arms.
- Can be used as a single unit or combines with other Resonate Modular Lounge units to form a modular lounge seating area.
- Use separately specified Alignment Clips to connect components together.
- Fully upholstered Seat, and Back cushions.
- Laminate platform with Natural Ply Edge edgebanding.
- Laminate available in:
  - Solid - Linen (H-WL), Putty (H-AA), Charcoal (H-8J)
  - Wood Grain - Field Elm (H- KP), Landmark (H-KM), Neo Walnut (H-KL)
- Edgeband standard in Natural Ply Edge (HP-PW)
- Painted steel frame available in:
  - Blue Jay (TR-1G)
  - Charcoal (TR-K)
  - Rusty Red (TR-RR)
  - Smooth Plaster (TR-PLS)
- Glides available in non-marring felt or hard plastic.

### Ottoman

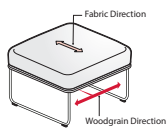

#### Features

- Ottoman features a fully upholstered foot/seat cushion.
- Can be used as a single unit or combined with other Resonate Modular Lounge units to form a modular lounge seating area.
- Use separately specified Alignment Clips to connect components together.
- Laminate platform with Natural Ply Edge edgebanding.
- Laminate available in:
  - Solid - Linen (H-WL), Putty (H-AA), Charcoal (H-8J)
  - Wood Grain - Field Elm (H- KP), Landmark (H-KM), Neo Walnut (H-KL)
- Edgeband standard in Natural Ply Edge (HP-PW)
- Painted steel frame available in:
  - Blue Jay (TR-1G)
  - Charcoal (TR-K)
  - Rusty Red (TR-RR)
  - Smooth Plaster (TR-PLS)
- Glides available in non-marring felt or hard plastic.

# Resonate

## At-A-Glance — General Specifications

### Table



#### Features

- Table features a High-Pressure Laminate (HPL) top with painted steel legs.
- Can be used as a single unit or combined with other Resonate Modular Lounge units to form a modular lounge seating area.
- Use separately specified Alignment Clips to connect components together.
- Laminate top available in:  
Solid - Linen (H-WL), Putty (H-AA), Charcoal (H-8J)  
Wood Grain - Field Elm (H- KP), Landmark (H-KM), Neo Walnut (H-KL)
- Edgeband standard in Natural Ply Edge (HP-PW)
- Painted steel frame available in:  
Blue Jay (TR-1G)  
Charcoal (TR-K)  
Rusty Red (TR-RR)  
Smooth Plaster (TR-PLS)
- Glides available in non-marring felt or hard plastic.

### Alignment Clip

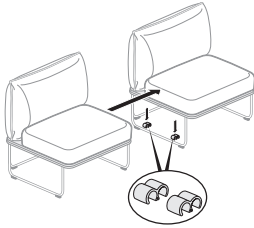

#### Features

- Optional Alignment Clips are used to gang one Resonate Modular Lounge unit to another.
- Alignment Clips are sold as a box of 12 clips.
- Alignment clips may be used at any location on the frame.
- Recommend using two clips per connection.
- Clips available in:  
Blue Jay (TR-1G)  
Charcoal (TR-K)  
Rusty Red (TR-RR)  
Smooth Plaster (TR-PLS)

### Side Chair



#### Features

- Seat and back made from molded plywood with High-Pressure Laminate (HPL) face and back with exposed plywood edges or upholstered.
- Wood grain laminate direction:  
–Seat: Front to back  
–Back: Vertical
- Painted steel frame available in:  
Blue Jay (TR-1G)  
Charcoal (TR-K)  
Rusty Red (TR-RR)  
Smooth Plaster (TR-PLS)
- Glides available in non-marring felt or hard plastic. Smooth Plaster frame will have Smooth Plaster glides. All other frame colors will have Black glides.
- Chairs do not stack.

### Lounge Chair



#### Features

- Seat and back made from molded plywood with High-Pressure Laminate (HPL) face and back with exposed plywood edges or upholstered.
- Wood grain laminate direction:  
–Seat: Front to back  
–Back: Vertical
- Painted steel frame available in:  
Blue Jay (TR-1G)  
Charcoal (TR-K)  
Rusty Red (TR-RR)  
Smooth Plaster (TR-PLS)
- Glides available in non-marring felt or hard plastic. Smooth Plaster frame will have Smooth Plaster glides. All other frame colors will have Black glides.
- Chairs do not stack.

# Resonate — Modular Lounge

## Corner

### Left/Right Hand

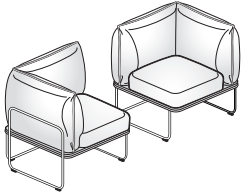

SRMR  
SRML  
Class RL

#### Features

- Includes on left or right-hand corner unit with fully upholstered seat and back cushions mounted on a high-pressure laminate (HPL) platform and painted steel legs.
- Laminate platform edgeband available in Ply-edge (HP-PW) only.
- COM yardage/COL square footage: 4.25/39  
Seat: 1.25/9  
Back/Arms: 3.0/30

#### Specification Tip

- Can be used as stand alone seating or connected to Resonate tables or additional Resonate Modular Lounge units.

For mixed grade fabric surfaces, please refer to the electronic design and specification tools for these prices.

#### Dimensions

H: 32.0"(813mm)      D: 28.5"(724mm)      W: 28.5"(724mm)  
SH: 18.75"(476mm)      SD: 18.75"(476mm)      SW: 18.75"(476mm)

#### To Order, Specify:

1) Product number, including:

##### 1 Seat Material:

- 1 Leather
- 2 Fabric
- 3 Faux Leather

##### 2 Back Material:

- 1 Leather
- 2 Fabric
- 3 Faux Leather

##### 3 Glide Option:

- H Hard
- K Felt

2) Seat material and color.

3) Back material and color.

4) Laminate for platform.

5) Frame color.

(Note: TR-PLS Smooth Plaster (add **\$95.78** list).)

Description	Number ① ② ③	Fabric								Leather	
		A	B	C	D	E	F	G	H	A	B
<b>Platform - HPL A</b>											
Right Corner	SRMR-■-■-■	\$2349.56	\$ 2575.13	\$2649.79	\$2753.16	\$2896.31	\$3553.78	\$3855.85	\$4395.66	\$3767.06	\$4452.69
Left Corner	SRML-■-■-■	2349.56	2575.13	2649.79	2753.16	2896.31	3553.78	3855.85	4395.66	3767.06	4452.69
<b>Platform - HPL B</b>											
Right Corner	SRMR-■-■-■	\$2378.48	\$2604.05	\$2678.71	\$2782.08	\$2925.23	\$3582.70	\$3884.77	\$4424.58	\$3795.98	\$ 4481.61
Left Corner	SRML-■-■-■	2378.48	2604.05	2678.71	2782.08	2925.23	3582.70	3884.77	4424.58	3795.98	4481.61

The following option requires modification of the product number.

Stain repellent

To specify, add **P** to the end of the product number, (add **\$85.46** list); **Example:** SRMR-22-HP

# Resonate — Modular Lounge

## Straight Back

### Back/No Arms

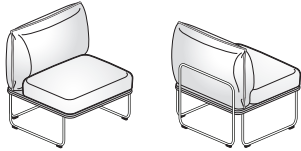

SRMB  
Class RL

#### Features

- Includes one straight back unit with fully upholstered seat and back cushion mounted on a high-pressure laminate (HPL) platform and painted steel legs.
- Laminate platform edgeband available in Ply-edge (HP-PW) only.
- COM yardage/COL square footage: 2.75/26

Seat: 1.25/11

Back/Arms: 1.5/15

#### Specification Tip

- Can be used as stand alone seating or connected to Resonate tables or additional Resonate Modular Lounge units.

For mixed grade fabric surfaces, please refer to the electronic design and specification tools for these prices.

#### Dimensions

H: 32.0"(813mm)

D: 28.5"(724mm)

W: 28.0"(711mm)

SH: 18.75"(476mm)

SD: 18.75"(476mm)

SW: 28.5"(724mm)

#### To Order, Specify:

1) Product number, including:

##### 1 Seat Material:

- 1 Leather
- 2 Fabric
- 3 Faux Leather

##### 2 Back Material:

- 1 Leather
- 2 Fabric
- 3 Faux Leather

##### 3 Glide Option:

- H Hard
- K Felt

2) Seat material and color.

3) Back material and color.

4) Laminate for platform.

5) Frame color.

(Note: TR-PLS Smooth Plaster (add **\$95.78** list).)

Description	Number ① ② ③	Fabric								Leather	
		A	B	C	D	E	F	G	H	A	B
<b>Platform - HPL A</b>											
Back/No Arms	SRMB-■-■-■	\$1836.27	\$2012.57	\$2070.90	\$ 2151.67	\$2263.59	\$ 2777.42	\$ 3013.49	\$3435.38	\$2944.11	\$3479.95
<b>Platform - HPL B</b>											
Back/No Arms	SRMB-■-■-■	\$1865.19	\$2041.49	\$2099.82	\$2180.59	\$2292.51	\$2806.34	\$3042.41	\$3464.30	\$2973.03	\$3508.87

The following option requires modification of the product number.

Stain repellent

To specify, add **P** to the end of the product number, (add **\$73.67** list); **Example:** SRMB-22-HP

# Resonate — Modular Lounge Ottoman



SRON  
Class RL

### Features

- Includes one ottoman with fully upholstered cushion mounted on a high-pressure laminate (HPL) platform and painted steel legs.
- Laminate platform edgeband available in Ply-edge (HP-PW) only.
- COM yardage/COL square footage: 1.25/15

### Specification Tip

- Ottoman can be connected into a sofa configuration for a no back seating option.

### Dimensions

H: 18.75"(476mm)      D: 28.0"(711mm)      W: 28.0"(711mm)

### To Order, Specify:

1) Product number, including:

#### 1 Seat Material:

- 1 Leather
- 2 Fabric
- 3 Faux Leather

#### 2 Glide Option:

- H Hard
- K Felt

2) Seat material and color.

3) Laminate for platform.

4) Frame color.

(Note: TR-PLS Smooth Plaster (add **\$95.78** list).)

Description	Number		Fabric							Leather		
	1	2	A	B	C	D	E	F	G	H	A	B
<b>Platform - HPL A</b>												
Back/No Arms	SRON-	N-	\$1250.69	\$1370.76	\$1410.50	\$1465.52	\$1541.74	\$1891.69	\$2052.49	\$2339.85	\$2005.24	\$2370.19
<b>Platform - HPL B</b>												
Back/No Arms	SRON-	N-	\$1279.61	\$1399.68	\$1439.42	\$1494.44	\$1570.66	\$1920.61	\$2081.41	\$2368.77	\$2034.16	\$2399.11

The following option requires modification of the product number.

Stain repellent

To specify, add **P** to the end of the product number, (add **\$58.94** list); **Example: SRON-2N-HP**

# Resonate — Modular Lounge Table

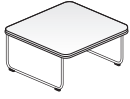

SRTL  
Class RL

**Features**

- Includes one high-pressure laminate (HPL) top table on painted steel legs.
- Laminate edgeband available in Ply-edge (HP-PW) only.

**Dimensions**

H: 12.0"(305mm)      D: 27.5"(699mm)      W: 27.5"(699mm)

**To Order, Specify:**

1) Product number, including:

**1 Glide Option:**

**H** Hard

**K** Felt

2) Laminate color.

3) Frame color.

(Note: TR-PLS Smooth Plaster add **\$95.78** list.)

Number ①	HPL	
	A	B
SRTL-2828-■	\$795.23	\$874.76

# Resonate — Modular Lounge

## Alignment Clip

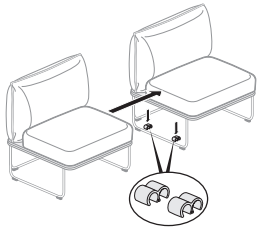

SRA-1  
Class RL

### Features

- Includes one box of 12 alignment clips.
- Alignment clips available in:
  - Blue Jay (TR-1G)
  - Charcoal (TR-K)
  - Rusty Red (TR-RR)
  - Smooth Plaster (TR-PLS)

### Specification Tip

- Alignment clips can be used at any location on the frame to connect Resonate Modular Lounge units or tables together to keep in alignment.

### To Order, Specify:

- 1) Product number.
- 2) Trim color.

Number	Price
SRA-1	\$45.12

# Resonate — Side Chair

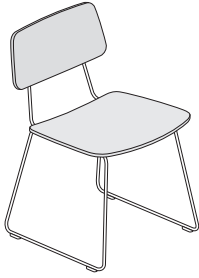

SRC-LL

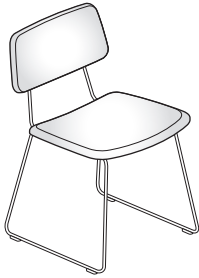

SRC-22  
Class RL

### Features

- Seat: Molded plywood with high-pressure laminate (HPL) face and back with exposed plywood edges or upholstered.
- Back: 8"(203mm)H x 18"(457mm)W molded plywood with laminate face and back and with exposed plywood edges or fully upholstered.
- Wood grain laminate direction on seat is front to back.
- Wood grain laminate direction on back is vertical.
- Frame: Painted steel with hard or felt glides.
- Glides: Smooth Plaster base will have Smooth Plaster glides. All other trim colors will have Black glides.
- Chairs do not have any stacking capability.
- COM yardage/COL square footage:  
Seat: 1.0/18  
Back: 0.5/9

For mixed grade fabric surfaces, please refer to the electronic design and specification tools for these prices.

### Dimensions

H: 29.75"(756mm)      D: 20.10"(511mm)      W: 19.75"(502mm)  
SH: 16.75"(425mm)      SD: 16.75"(425mm)      SW: 19.75"(502mm)

### To Order, Specify:

1) Product number, including;

**1 Seat Material:**

- L** Laminate
- 1** Leather
- 2** Fabric
- 3** Faux Leather

**2 Back Material:**

- L** Laminate
- 1** Leather
- 2** Fabric
- 3** Faux Leather

**3 Glide Option:**

- H** Hard
- K** Felt

2) Seat material and color.

3) Back material and color.

4) Frame trim color.

(Note: TR-PLS Smooth Plaster (add **\$95.78** list).)

Back	Number ③	HPL Seat	
		A	B
<b>Non-Upholstered</b>			
HPL A	SRC-LL-█	\$906.59	\$951.90
HPL B	SRC-LL-█	951.90	997.21

Back	Number ① ②	Fabric								Leather	
		A	B	C	D	E	F	G	H	A	B
<b>Upholstered Seat</b>											
HPL A	SRC-█ L-█	\$938.40	\$ 994.69	\$ 1021.55	\$1081.82	\$ 1121.84	\$1304.69	\$1420.83	\$1609.79	\$1323.24	\$1564.06
HPL B	SRC-█ L-█	983.71	1040.00	1066.86	1127.13	1167.15	1350.00	1466.14	1655.10	1368.55	1609.37

Back	Number ① ② ③	Fabric								Leather	
		A	B	C	D	E	F	G	H	A	B
<b>Upholstered Seat and Back</b>											
Upholstered	SRC-█ █ - █	\$975.99	\$1034.52	\$1062.45	\$1125.15	\$1166.76	\$1356.95	\$1477.72	\$1674.24	\$1376.24	\$1626.71

The following option requires modification of the product number.

Stain repellent

To specify, add **P** to the end of the product number, (add **\$58.94** list); **Example:** SRC-22-HP

# Resonate — Lounge Chair

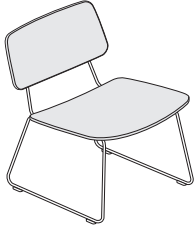

SRL-LL



SRL-22  
Class RL

### Features

- Seat: Molded plywood with high-pressure laminate (HPL) face and back with exposed plywood edges or upholstered.
- Back: 10"(254mm)H x 21.45"(545mm)W molded plywood with laminate face and back and with exposed plywood edges or fully upholstered.
- Wood grain laminate direction on seat is front to back.
- Wood grain laminate direction on back is vertical.
- Frame: Painted steel with hard or felt glides.
- Glides: Smooth Plaster base will have Smooth Plaster glides. All other trim colors will have Black glides.
- Chairs do not have any stacking capability.
- COM yardage/COL square footage:  
Seat: 1.0/18  
Back: 0.5/9

For mixed grade fabric surfaces, please refer to the electronic design and specification tools for these prices.

### Dimensions

H: 26.25"(667mm)      D: 22.50"(572mm)      W: 23.20"(589mm)  
SH: 14.90"(378mm)      SD: 18.50"(470mm)      SW: 23.20"(589mm)

### To Order, Specify:

1) Product number, including;

**1 Seat Material:**

- L** Laminate
- 1** Leather
- 2** Fabric
- 3** Faux Leather

**2 Back Material:**

- L** Laminate
- 1** Leather
- 2** Fabric
- 3** Faux Leather

**3 Glide Option:**

- H** Hard
- K** Felt

2) Seat material and color.

3) Back material and color.

4) Frame trim color.

(Note: TR-PLS Smooth Plaster (add **\$95.78** list).)

Back	Number <sup>③</sup>	HPL Seat	
		A	B
<b>Non-Upholstered</b>			
HPL A	SRL-LL-■	\$968.75	\$ 1017.18
HPL B	SRL-LL-■	1017.18	1065.61

Back	Number <sup>① ②</sup>	Fabric								Leather	
		A	B	C	D	E	F	G	H	A	B
<b>Upholstered Seat</b>											
HPL A	SRL-■L-■	\$1002.02	\$1062.12	\$1090.79	\$ 1155.15	\$ 1197.88	\$1393.15	\$ 1517.14	\$1718.90	\$1412.96	\$1670.10
HPL B	SRL-■L-■	1050.45	1110.55	1139.22	1203.58	1246.31	1441.58	1565.57	1767.33	1461.39	1718.53

Back	Number <sup>① ② ③</sup>	Fabric								Leather	
		A	B	C	D	E	F	G	H	A	B
<b>Upholstered Seat and Back</b>											
Upholstered	SRL-■-■-■	\$1042.50	\$1105.03	\$1134.85	\$1201.82	\$1246.27	\$1449.44	\$1578.44	\$1788.34	\$1470.04	\$1737.57

The following option requires modification of the product number.

Stain repellent

To specify, add **P** to the end of the product number, (add **\$66.32** list); **Example:** SRL-22-HP

# Riverbend and Pebble

## At-A-Glance

### Environmental Factors

BIFMA Level 2 Certified  
Greenguard / Greenguard Gold Certified.

### Fabrics and Finishes

A complete listing of fabrics and finishes for Riverbend and Pebble is available in the back of the price list. Fabric is applied Railroaded to both Riverbend and Pebble products. Linear or patterned fabric is not recommended due to the manner in which fabric is applied. Material will not be pattern matched.

Riverbend sofas and Pebble ottomans feature large, flat surfaces, and textile crispness will be influenced by the amount of stretch in each textile. Some textiles will stretch more than others, resulting in a small amount of pooling. This can be addressed by running a hand across the surface to smooth the material.

### Stain Repellent

To specify add **"P"** to end of the product number.  
Example: SMSN-2028-HNFP

### Specifications

Designed for use by individuals up to 325 lbs.

### Catalog Logic

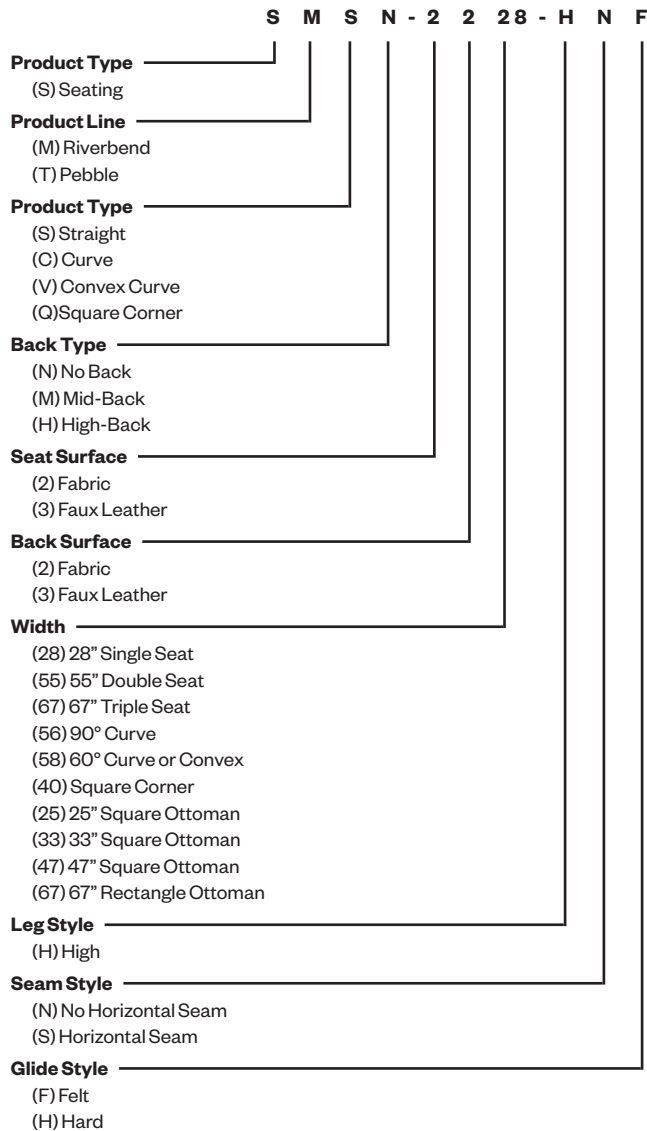

# Riverbend and Pebble

## At-A-Glance

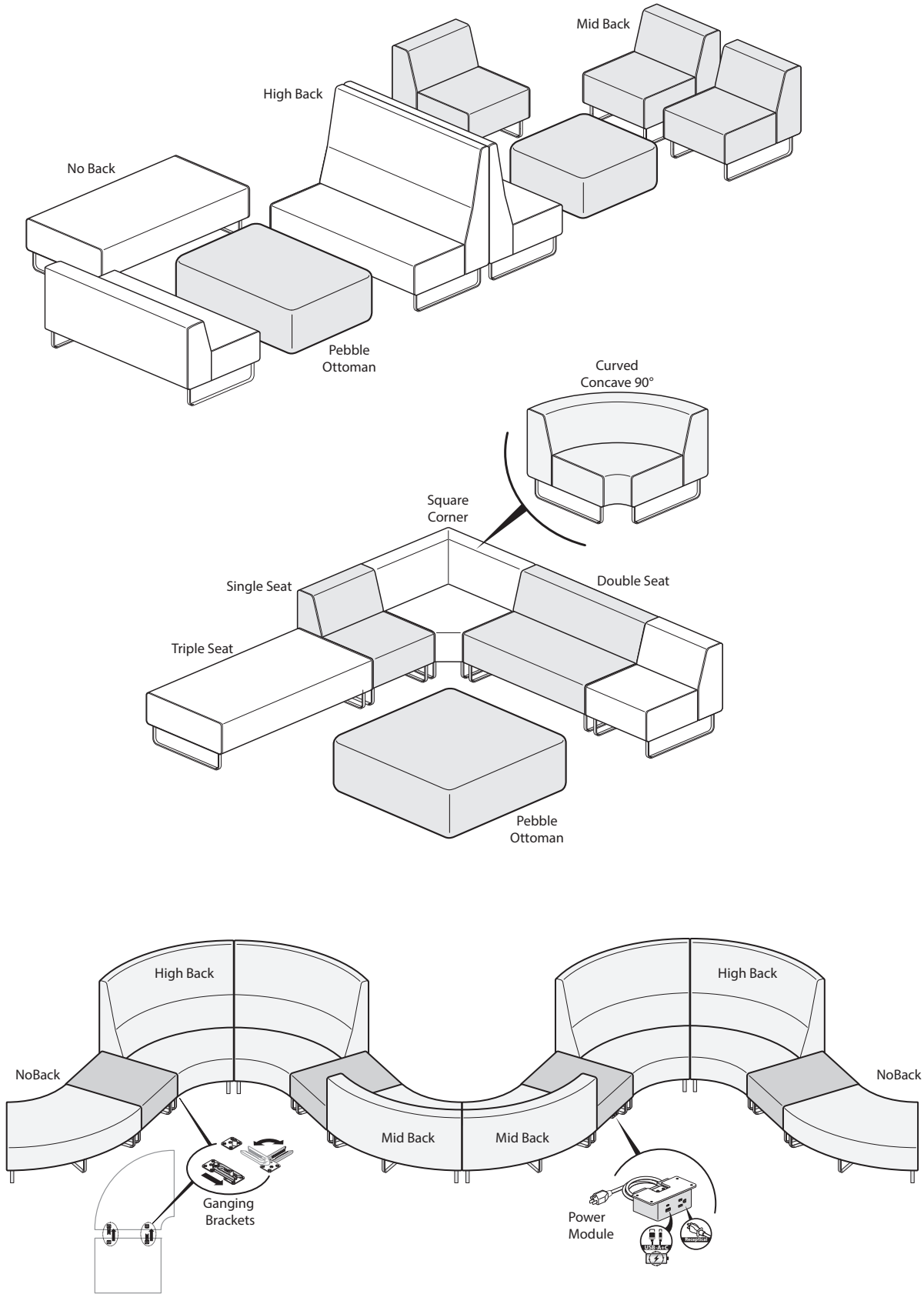

# Riverbend and Pebble

## At-A-Glance

### Seam Options

**No Horizontal Seam**

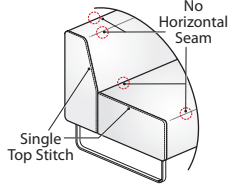

**Horizontal Seam**

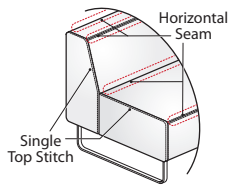

Riverbend units are available with and without a double-needle stitch horizontal seam.

When specified without horizontal seams, textiles will gently flow over the front and back edges of the seat and back, providing a simple and seamless aesthetic.

For a tailored aesthetic, Riverbend units can be specified with a horizontal seam along the front and back edges of the seat and back.

### Ganging Bracket

Ganging brackets are used to gang one Riverbend component to another. When not in use the ganging bracket pivots to hide under the seat. Each Ganging Bracket Kit includes two brackets, screws, a template and assembly instructions. One kit will gang two sofas together.

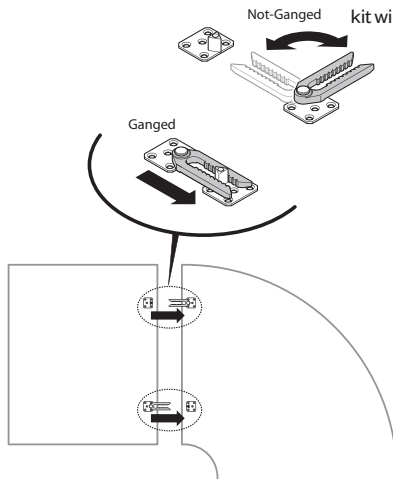

### Power Module

The separately specified power module provides under seat power consisting of either one or two simplex outlets (NEMA-5-15R) and one dual USB A-C. (20W shared between A and C). The Power Module must be installed along the front edge of the Riverbend seat. Power Modules may not be daisy chained together.

The Power Module is available either corded or hardwire with a 6'(1829mm) or 12'(3658mm) cord.

Included with the module are two cord management clips and attachment hardware.

Application may require approval from local authority having jurisdiction (AHJ); ensure compliance before placing orders and installing.

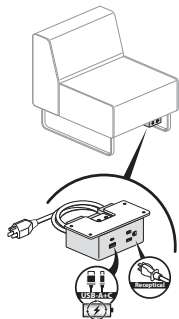

# Riverbend and Pebble

## At-A-Glance

### Single Seat

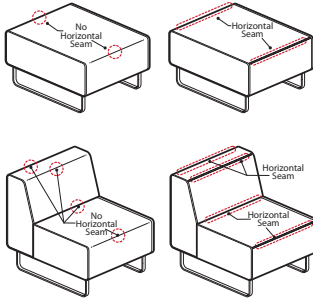

#### Features

- Back Option: No Back, Mid-Back
- Available with horizontal seams or without horizontal seams. Horizontal seam location noted by red lines.
- Seat width 27.6"(701mm)
- Available with hard plastic or felt glides.
- Accepts separately specified power module for under seat power access.
- Use separately specified ganging bracket to connect components together.

### Double Seat

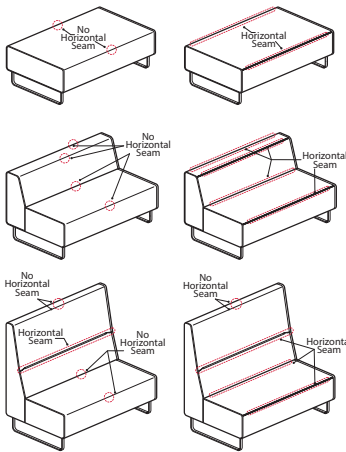

#### Features

- Back Option: No Back, Mid-Back, High-Back
- Available with horizontal seams or without horizontal seams. Horizontal seam location noted by red lines.
- Seat width 55"(1397mm)
- Available with hard plastic or felt glides.
- Accepts separately specified power module for under seat power access.
- Use separately specified ganging bracket to connect components together.

### Triple Seat

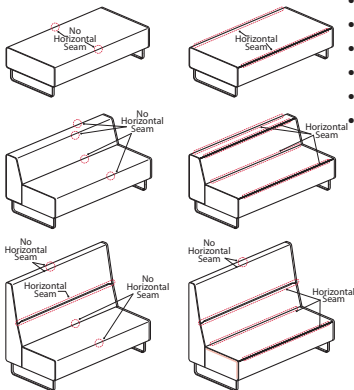

#### Features

- Back Option: No Back, Mid-Back, High-Back
- Available with horizontal seams or without horizontal seams. Horizontal seam location noted by red lines.
- Seat width 67"(1702mm)
- Available with hard plastic or felt glides.
- Accepts separately specified power module for under seat power access.
- Use separately specified ganging bracket to connect components together.

# Riverbend and Pebble

## At-A-Glance

### 90° Curved – Concave

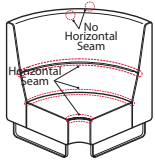
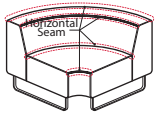
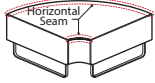

#### Features

- Back Option: No Back, Mid-Back, High-Back
- Available with horizontal seams only. Horizontal seam placement noted in red.
- Available with hard plastic or felt glides.
- Accepts separately specified power module for under seat power access.
- Use separately specified ganging bracket to connect components together.

### 60° Curved – Concave

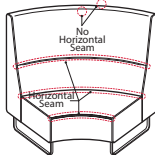
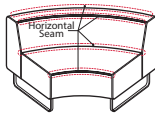
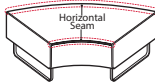

#### Features

- Back Option: No Back, Mid-Back, High-Back
- Available with horizontal seams only. Horizontal seam placement noted in red.
- Available with hard plastic or felt glides.
- Accepts separately specified power module for under seat power access.
- Use separately specified ganging bracket to connect components together.

### 60° Curved – Convex

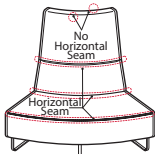
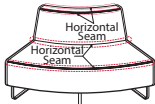

#### Features

- Back Option: Mid-Back, High-Back
  - For No Back option use 60° Curved – Concave.
- Available with horizontal seams only. Horizontal seam placement noted in red.
- Available with hard plastic or felt glides.
- Accepts separately specified power module for under seat power access.
- Use separately specified ganging bracket to connect components together.

# Riverbend and Pebble

## At-A-Glance

### Square Corner

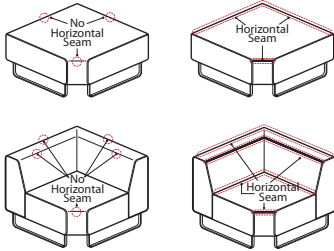

#### Features

- Back Option: No Back, Mid-Back
- Available with horizontal seams or without horizontal seams. Horizontal seam location noted in red.
- Available with hard plastic or felt glides.
- Accepts separately specified power module for under seat power access.
- Use separately specified ganging bracket to connect components together.

### Pebble Ottoman

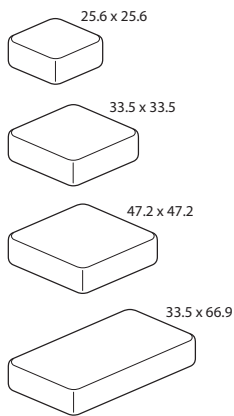

#### Features

- Available in two shapes and four sizes.
  - Square - Small - 25.6"(650mm)
  - Square - Medium - 33.5"(851mm)
  - Square - Large - 47.2"(1199mm)
  - Rectangle - 66.9"(1699mm)W X 33.5"(851mm)D
- Available with hard plastic or felt glides.

# Riverbend

## Straight

### Single Seat

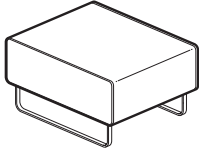

SMSN-2028-H

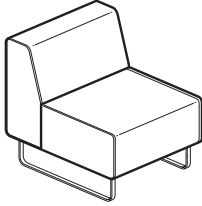

SMSM-2228-H  
Class QA

#### Features

- Includes upholstered seat and back (if applicable) and painted steel legs.
- Seat and back available in same surface and color or different surface and color.
- Available with hard plastic glides or felt glides.
- Available with or without horizontal seams. When ordering with horizontal seams there will be a seam across the front of the seat and across the top of the mid-back.
- COM yardage:  
No Back: 2.4  
Mid-Back: 4.25 (seat 2.1/back 2.1)

#### Specification Tips

- Fabric applied railroaded.
- Linear or patterned fabric not recommended due to the manner in which fabric is applied.
- Ganging bracket available (ordered separately) to attach adjacent Riverbend products.
- Separately specified power module available for under seat power access.
- When using with adjacent curved corner unit, specify with seam option to maintain a consistent seam line across the front of the entire configuration.
- For accent pillows, refer to Openest Price List.

#### Dimensions

Height:	Depth:	Width:
H: 17.8"(452mm) -	D: 33.8"(859mm)	W: 27.6"(701mm)
No Back	SD: 33.8"(859mm) -	
30.7"(780mm) -	No Back	
Mid-Back	22.6"(574mm) -	
SH: 17.8"(452mm)	Mid-Back	

#### To Order, Specify:

1) Product number, including:

**1 Seat Surface:**

- 2** Fabric
- 3** Faux Leather

**2 Back Surface:**

- 2** Fabric
- 3** Faux Leather

**3 Glide Style:**

- H** Hard
- F** Felt

2) Seat fabric surface and color.

3) Back fabric surface and color.

4) Trim color.

**Note:** For mixed grade surface materials, please refer to the electronic design and specification tools for pricing.

Description	Number		Fabric							
	①	②	A	B	C	D	E	F	G	H
<b>Without Horizontal Seams</b>										
No Back	SMSN-	028-HN	\$ 1798.07	\$ 1953.98	\$ 2005.75	\$ 2076.22	\$ 2173.28	\$ 2632.91	\$ 3015.45	\$ 3453.63
Mid-Back	SMSM-	28-HN	2678.79	2948.34	3027.59	3152.28	3311.13	4084.99	4436.33	5068.93
<b>With Horizontal Seams</b>										
No Back	SMSN-	028-HS	\$ 1905.93	\$ 2061.84	\$ 2113.61	\$ 2184.08	\$ 2281.14	\$ 2740.77	\$ 3123.31	\$ 3561.49
Mid-Back	SMSM-	28-HS	2786.65	3056.20	3135.45	3260.14	3418.99	4192.85	4544.19	5176.79

The following options require modification of the product number.

Stain Repellent

To specify, add **P** to end of the product number (No Back - add **\$104.21** list, Mid-Back - add **\$179.32** list);

**Example:** SMSN-2028-HNFP

# Riverbend

## Straight

### Double Seat

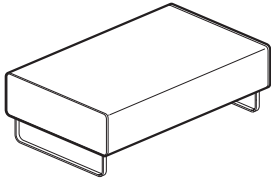

SMSN-2055-H

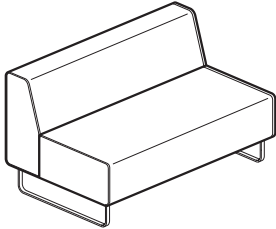

SMSM-2255-H

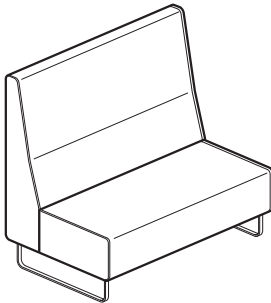

SMSH-2255-H  
Class QA

### Features

- Includes upholstered seat and back (if applicable) and painted steel legs.
- Seat and back available in same surface and color or different surface and color.
- Available with hard plastic glides or felt glides.
- Available with or without horizontal seams. When ordering with horizontal seams there will be a seam across the front of the seat and across the top of the mid-back.
- COM yardage:  
No Back: 4.2  
Mid-Back: 7.2 (seat 4.2/back 3.0)  
High-Back: 9.4 (seat 4.2/back 5.2)

### Specification Tips

- Fabric applied railroaded.
- Linear or patterned fabric not recommended due to the manner in which fabric is applied.
- Ganging bracket available (ordered separately) to attach adjacent Riverbend products.
- Separately specified power module available for under seat power access.
- When using with adjacent curved corner unit, specify with seam option to maintain a consistent seam line across the front of the entire configuration.
- For accent pillows, refer to Openest Price List.

### Dimensions

Height:	Depth:	Width:
H: 17.8"(452mm) -	D: 33.8"(859mm)	W: 55"(1397mm)
No Back	SD: 33.8"(859mm) -	
30.7"(780mm) -	No Back	
Mid-Back	22.6"(574mm) -	
49.6"(1260mm) -	Mid-Back	
High-Back	22.6"(574mm) -	
SH: 17.8"(452mm)	High-Back	

### To Order, Specify:

1) Product number, including:

**1 Seat Surface:**

- 2** Fabric
- 3** Faux Leather

**2 Back Surface:**

- 2** Fabric
- 3** Faux Leather

**3 Glide Style:**

- H** Hard
- F** Felt

2) Seat fabric surface and color.

3) Back fabric surface and color.

4) Trim color.

**Note:** For mixed grade surface materials, please refer to the electronic design and specification tools for pricing.

Description	Number		Fabric							
	①	②	A	B	C	D	E	F	G	H
<b>Without Horizontal Seams</b>										
No Back	SMSN-	055-HN	\$2964.95	\$3186.34	\$3259.40	\$3361.54	\$3498.22	\$4151.21	\$4447.81	\$4981.52
Mid-Back	SMSM-	55-HN	3845.67	4223.93	4348.73	4520.39	4760.67	5866.79	6371.97	7281.27
High-Back	SMSH-	55-HN	4900.63	5401.55	5567.48	5794.25	6108.69	7580.83	8250.73	9456.60
<b>With Horizontal Seams</b>										
No Back	SMSN-	055-HS	\$3072.81	\$3294.20	\$3367.26	\$3469.40	\$3606.08	\$4259.07	\$4555.67	\$5089.38
Mid-Back	SMSM-	55-HS	3953.53	4331.79	4456.59	4628.25	4868.53	5974.65	6479.83	7389.13
High-Back	SMSH-	55-HS	5008.49	5509.41	5675.34	5902.11	6216.55	7688.69	8358.59	9564.46

The following options require modification of the product number.

Stain Repellent

To specify, add **P** to end of the product number (No Back - add **\$147.71** list, Mid-Back - add **\$253.18** list, High-Back - add **\$337.58** list); **Example:** SMSN-2055-HNFP

# Riverbend

## Straight

### Triple Seat

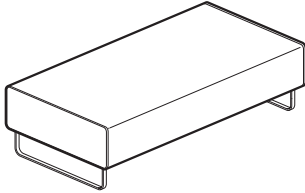

SMSN-2067-H

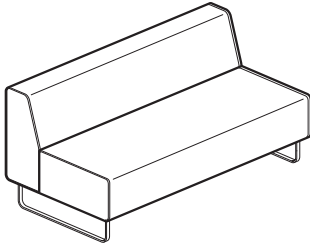

SMSM-2267-H

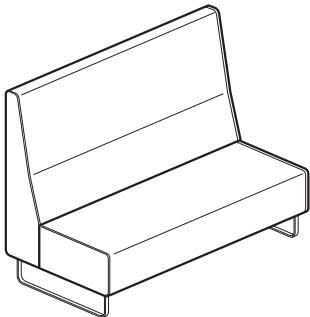

SMSH-2267-H  
Class QA

#### Features

- Includes upholstered seat and back (if applicable) and painted steel legs.
- Seat and back available in same surface and color or different surface and color.
- Available with hard plastic glides or felt glides.
- Available with or without horizontal seams. When ordering with horizontal seams there will be a seam across the front of the seat and across the top of the mid-back.
- COM yardage:  
No Back: 5.0  
Mid-Back: 8.5 (seat 5.0/back 3.5)  
High-Back: 11.4 (seat 5.0/back 6.4)

#### Specification Tips

- Fabric applied railroaded.
- Linear or patterned fabric not recommended due to the manner in which fabric is applied.
- Ganging bracket available (ordered separately) to attach adjacent Riverbend products.
- Separately specified power module available for under seat power access.
- When using with adjacent curved corner unit, specify with seam option to maintain a consistent seam line across the front of the entire configuration.
- For accent pillows, refer to Openest Price List.

#### Dimensions

Height:	Depth:	Width:
H: 17.8"(452mm) -	D: 33.8"(859mm)	W: 67"(1702mm)
No Back	SD: 33.8"(859mm) -	
30.7"(780mm) -	No Back	
Mid-Back	22.6"(574mm) -	
49.6"(1260mm) -	Mid-Back	
High-Back	22.6"(574mm) -	
SH: 17.8"(452mm)	High-Back	

#### To Order, Specify:

1) Product number, including:

- 1 **Seat Surface:**
  - 2 Fabric
  - 3 Faux Leather
- 2 **Back Surface:**
  - 2 Fabric
  - 3 Faux Leather
- 3 **Glide Style:**
  - H Hard
  - F Felt

- 2) Seat fabric surface and color.
- 3) Back fabric surface and color.
- 4) Trim color.

**Note:** For mixed grade surface materials, please refer to the electronic design and specification tools for pricing.

Description	Number			Fabric							
	1	2	3	A	B	C	D	E	F	G	H
<b>Without Horizontal Seams</b>											
No Back	SMSN-	067-HN		\$3590.63	\$3845.24	\$3928.95	\$4045.48	\$4202.79	\$4952.68	\$5293.17	\$5905.97
Mid-Back	SMSM-	67-HN		4471.35	4914.13	5060.25	5264.53	5545.51	6843.87	7437.07	8840.59
High-Back	SMSH-	67-HN		5526.31	6124.97	6322.84	6598.63	6971.89	8733.70	9535.50	11551.03
<b>With Horizontal Seams</b>											
No Back	SMSN-	067-HS		\$3698.49	\$3953.10	\$4036.81	\$ 4153.34	\$ 4310.65	\$5060.54	\$ 5401.03	\$ 6013.83
Mid-Back	SMSM-	67-HS		4579.21	5021.99	5168.11	5372.39	5653.37	6951.73	7544.93	8948.45
High-Back	SMSH-	67-HS		5634.17	6232.83	6430.70	6706.49	7079.75	8841.56	9643.36	11658.89

The following options require modification of the product number.

Stain Repellent

To specify, add **P** to end of the product number (No Back - add **\$168.81** list, Mid-Back - add **\$295.39** list, High-Back - add **\$400.90** list); **Example:** SMSN-2067-HNFP

# Riverbend

## Curved — Concave

### 90° Concave

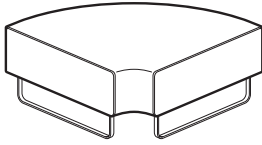

SMCN-2056-HS

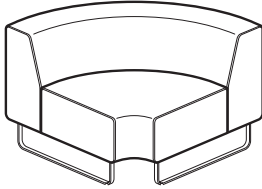

SMCM-2256-HS

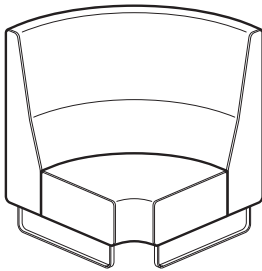

SMCH-2256-HS  
Class QA

#### Features

- Includes upholstered seat and back (if applicable) and painted steel legs.
- Seat and back available in same surface and color or different surface and color.
- Available with hard plastic glides or felt glides.
- Available with horizontal seam on seat front and back and across the top of the mid-back.
- COM yardage:  
No Back: 3.2  
Mid-Back: 6.1 (seat 2.75/back 3.35)  
High-Back: 7.25 (seat 2.75/back 4.5)

#### Specification Tips

- Fabric applied railroaded.
- Linear or patterned fabric not recommended due to the manner in which fabric is applied.
- Ganging bracket available (ordered separately) to attach adjacent Riverbend products.
- Separately specified power module available for under seat power access.
- For accent pillows, refer to Openest Price List.

#### Dimensions

Height:	Depth:	Width:
H: 17.8"(452mm) -	D: 33.8"(859mm)	W: 56.3"(1430mm)
No Back	SD: 33.8"(859mm) -	
30.7"(780mm) -	No Back	
Mid-Back	22.6"(574mm) -	
49.6"(1260mm) -	Mid-Back	
High-Back	22.6"(574mm) -	
SH: 17.8"(452mm)	High-Back	

#### To Order, Specify:

1) Product number, including:

**1 Seat Surface:**

- 2** Fabric
- 3** Faux Leather

**2 Back Surface:**

- 2** Fabric
- 3** Faux Leather

**3 Glide Style:**

- H** Hard
- F** Felt

- 2) Seat fabric surface and color.
- 3) Back fabric surface and color.
- 4) Trim color.

**Note:** For mixed grade surface materials, please refer to the electronic design and specification tools for pricing.

Description	Number			Fabric							
	1	2	3	A	B	C	D	E	F	G	H
No Back	SMCN-	056-HS		\$ 3215.57	\$ 3412.62	\$3477.82	\$ 3567.01	\$3689.55	\$ 4270.07	\$4533.61	\$5008.04
Mid-Back	SMCM-	56-HS		4123.76	4550.27	4691.18	4886.86	5150.63	6408.51	7455.54	8654.84
High-Back	SMCH-	56-HS		5536.55	6054.09	6223.87	6460.29	6780.84	8304.61	8996.47	10241.85

The following options require modification of the product number.

Stain Repellent

To specify, add **P** to end of the product number (No Back - add **\$135.03** list, Mid-Back - add **\$284.84** list, High-Back - add **\$348.16** list); **Example:** SMCN-2056-HSFP

# Riverbend

## Curved — Concave

### 60° Concave

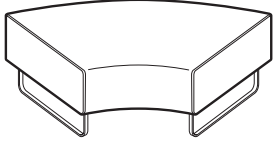

SMCN-2058-HS

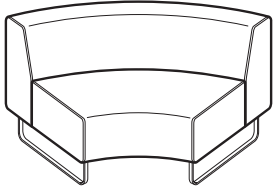

SMCM-2258-HS

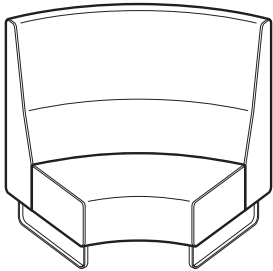

SMCH-2258-HS  
Class QA

#### Features

- Includes upholstered seat and back (if applicable) and painted steel legs.
- Seat and back available in same surface and color or different surface and color.
- Available with hard plastic glides or felt glides.
- Available with horizontal seam on seat front and back and across the top of the mid-back.
- COM yardage:  
No Back: 3.5  
Mid-Back: 7.0 (seat 3.0/back 4.0)  
High-Back: 8.1 (seat 3.0/back 5.1)

#### Specification Tips

- Fabric applied railroaded.
- Linear or patterned fabric not recommended due to the manner in which fabric is applied.
- Ganging bracket available (ordered separately) to attach adjacent Riverbend products.
- Separately specified power module available for under seat power access.
- For accent pillows, refer to Openest Price List.

#### Dimensions

Height:	Depth:	Width:
H: 17.8"(452mm) -	D: 33.8"(859mm)	W: 58.3"(1481mm)
No Back	SD: 33.8"(859mm) -	
30.7"(780mm) -	No Back	
Mid-Back	22.6"(574mm) -	
49.6"(1260mm) -	Mid-Back	
High-Back	22.6"(574mm) -	
SH: 17.8"(452mm)	High-Back	

#### To Order, Specify:

1) Product number, including:

**1 Seat Surface:**

- 2** Fabric
- 3** Faux Leather

**2 Back Surface:**

- 2** Fabric
- 3** Faux Leather

**3 Glide Style:**

- H** Hard
- F** Felt

- 2) Seat fabric surface and color.
- 3) Back fabric surface and color.
- 4) Trim color.

**Note:** For mixed grade surface materials, please refer to the electronic design and specification tools for pricing.

Description	Number			Fabric							
	1	2	3	A	B	C	D	E	F	G	H
No Back	SMCN-	058-HS		\$3485.32	\$ 3715.00	\$3790.47	\$3895.96	\$4038.19	\$ 4715.54	\$5023.05	\$ 5576.54
Mid-Back	SMCM-	58-HS		4393.51	4845.58	4994.05	5199.77	5479.62	6810.02	7917.49	9185.93
High-Back	SMCH-	58-HS		5806.26	6347.72	6526.70	6773.20	7109.57	8706.12	9430.90	10735.53

The following options require modification of the product number.

Stain Repellent

To specify, add **P** to end of the product number (No Back - add **\$158.25** list, Mid-Back - add **\$305.95** list, High-Back - add **\$358.70** list); **Example:** SMCN-2058-HSFP

# Riverbend

## Curved — Convex

### 60° Convex

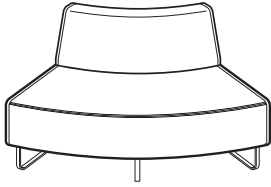

SMVM-2258-HS

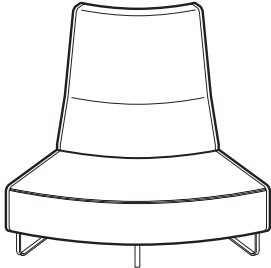

SMVH-2258-HS  
Class QA

#### Features

- Includes upholstered seat and back (if applicable) and painted steel legs.
- Seat and back available in same surface and color or different surface and color.
- Available with hard plastic glides or felt glides.
- Convex shape available as 60° only.
- Available with horizontal seam on seat front and back and across the top of the mid-back.
- COM yardage:  
Mid-Back: 6.0 (seat 3.0/back 3.0)  
High-Back: 6.75 (seat 3.0/back 3.75)

#### Specification Tips

- Fabric applied railroaded.
- Linear or patterned fabric not recommended due to the manner in which fabric is applied.
- Ganging bracket available (ordered separately) to attach adjacent Riverbend products.
- Separately specified power module available for under seat power access.
- For no back version use 60° Curve Concave.
- For accent pillows, refer to Openest Price List.

#### Dimensions

Height:	Depth:	Width:
H: 30.7"(780mm) -	D: 33.8"(859mm)	W: 58.3"(1481mm)
Mid-Back	SD: 22.6"(574mm)	
49.6"(1260mm) -		
High-Back		
SH: 17.8"(452mm)		

#### To Order, Specify:

1) Product number, including:

**1 Seat Surface:**

- 2** Fabric
- 3** Faux Leather

**2 Back Surface:**

- 2** Fabric
- 3** Faux Leather

**3 Glide Style:**

- H** Hard
- F** Felt

2) Seat fabric surface and color.

3) Back fabric surface and color.

4) Trim color.

**Note:** For mixed grade surface materials, please refer to the electronic design and specification tools for pricing.

Description	Number			Fabric							
	1	2	3	A	B	C	D	E	F	G	H
Mid-Back	SMVM-	58-HS		\$4450.41	\$4836.59	\$4964.19	\$ 5139.21	\$ 5378.63	\$6515.47	\$ 7031.61	\$7960.70
High-Back	SMVH-	58-HS		5863.15	6298.19	6442.27	6640.29	6909.76	8191.82	8773.81	9821.53

The following options require modification of the product number.

Stain Repellent

To specify, add **P** to end of the product number (Mid-Back - add **\$263.73** list, High-Back - add **\$295.39** list);

**Example:** SMVM-2258-HSFP

# Riverbend

## Corner — Square

### Corner – Square

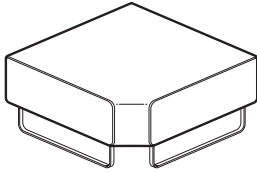

SMQN-2040-H

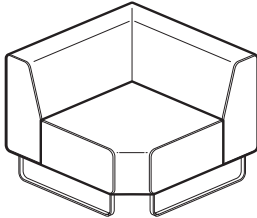

SMQM-2240-H  
Class QA

#### Features

- Includes upholstered seat and back (if applicable) and painted steel legs.
- Seat and back available in same surface and color or different surface and color.
- Available with hard plastic glides or felt glides.
- Available with or without horizontal seams. When order with horizontal seams there will be a seam across the front of the seat and across the top of the mid-back.
- COM yardage:  
No Back: 4.0  
Mid-Back: 7.0 (seat 4.0/back 3.0)

#### Specification Tips

- Fabric applied railroaded.
- Linear or patterned fabric not recommended due to the manner in which fabric is applied.
- Ganging bracket available (ordered separately) to attach adjacent Riverbend products.
- Separately specified power module available for under seat power access.
- For accent pillows, refer to Openest Price List.
- **Big Arrow fabric available however will not be pattern matched. Available with horizontal seam only.**

#### Dimensions

Height:	Depth:	Width:
H: 17.8"(452mm) -	D: 33.8"(859mm)	W: 40"(1016mm)
No Back	SD: 33.8"(859mm) -	
30.7"(780mm) -	No Back	
Mid-Back	22.6"(574mm) -	
SH: 17.8"(452mm)	Mid-Back	

#### To Order, Specify:

1) Product number, including:

**1 Seat Surface:**

- 2** Fabric
- 3** Faux Leather

**2 Back Surface:**

- 2** Fabric
- 3** Faux Leather

**3 Glide Style:**

- H** Hard
- F** Felt

2) Seat fabric surface and color.

3) Back fabric surface and color.

4) Trim color.

**Note:** For mixed grade surface materials, please refer to the electronic design and specification tools for pricing.

Description	Number			Fabric							
	1	2	3	A	B	C	D	E	F	G	H
<b>Without Horizontal Seams</b>											
No Back	SMQN-	040-HN		\$ 3977.74	\$ 4176.58	\$ 4287.40	\$ 4501.76	\$ 4712.56	\$ 5419.36	\$ 5852.86	\$ 6672.16
Mid-Back	SMQM-	40-HN		4895.11	5335.64	5602.34	5994.50	6275.25	7404.65	8145.07	9529.62
<b>With Horizontal Seams</b>											
No Back	SMQN-	040-HS		\$ 4161.21	\$ 4360.05	\$ 4470.87	\$ 4685.23	\$ 4896.03	\$ 5602.83	\$ 6036.33	\$ 6855.63
Mid-Back	SMQM-	40-HS		5078.58	5519.11	5785.81	6177.97	6458.72	7588.12	8328.54	9713.09

The following options require modification of the product number.

Stain Repellent

To specify, add **P** to end of the product number (No Back - add **\$113.06** list, Mid-Back - add **\$244.24** list);

**Example:** SMQN-2040-HNFP

# Pebble Ottoman

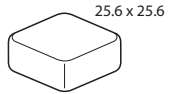

STSN-2025-HN

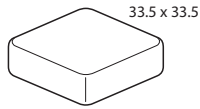

STSN-2033-HN

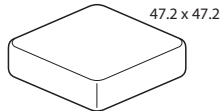

STSN-2047-HN

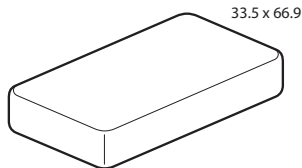

STSN-2067-HN  
Class QA

### Features

- Includes one ottoman with glides.
- Glides available in hard plastic or felt.
- COM yardage:
  - Square - Small: 3.0
  - Square - Medium: 3.75
  - Square - Large: 5.25
  - Rectangle: 6.1

### Specification Tips

- Fabric applied railroaded.
- Linear or patterned fabric not recommended due to the manner in which fabric is applied.

### To Order, Specify:

1) Product number, including:

**1 Surface Material:**

- 2** Fabric
- 3** Faux Leather

**2 Glide Style:**

- H** Hard
- F** Felt

2) Surface material and color.

Description	Height	Depth	Width	Number		Fabric							
				①	②	A	B	C	D	E	F	G	H
Square - Small	16.9"(429mm)	25.6"(650mm)	25.6"(650mm)	STSN-025-HN		\$ 1577.88	\$ 1762.01	\$ 1821.76	\$ 1906.01	\$ 2011.34	\$ 2544.26	\$ 2785.77	\$ 3220.53
Square - Medium		33.5"(851mm)	33.5"(851mm)	STSN-033-HN		1851.26	2088.97	2166.37	2275.16	2421.37	3124.76	3443.08	4016.02
Square - Large		47.2"(1199mm)	47.2"(1199mm)	STSN-047-HN		3113.56	3441.80	3550.08	3699.40	3900.23	4870.19	5309.24	6099.54
Rectangle		33.5"(851mm)	66.9"(1699mm)	STSN-067-HN		3082.37	3464.17	3590.12	3763.96	4005.72	5146.13	6091.89	7175.13

The following options require modification of the product number.

Stain Repellent

To specify, add **P** to end of the product number (Square - Small - add **\$126.59** list, Square - Medium - add **\$158.25** list, Square - Large - add **\$221.55** list, Rectangle - add **\$257.42** list); **Example:** STSN-2025-HNFP

# Riverbend Accessories

## Ganging Bracket

### Features

- Includes 2 brackets, screws, assembly instructions and template.
- Available in black only.

### Specification Tip

- Used to gang two Riverbend components together.

### To Order, Specify:

- 1) Product number.  
(No finish specification required.)

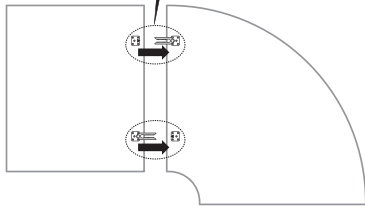
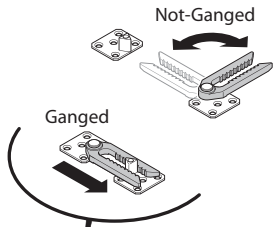

SMG-1  
Class QA

Number	Price
SMG-1	\$201.81

# Riverbend Power Module

## Corded

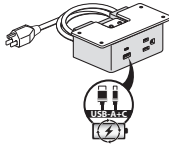

USM-PFOW-1100  
USM-PLOW-1100

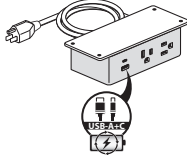

EUSM-PFOW-2100  
EUSM-PLOW-2100



Class QA

### Features

- Includes power module, two cord management clips, mounting brackets and attachment hardware.
- Power module consists of either one or two simplex outlets (NEMA-5-15R) and one dual USB A-C. (20W shared between A and C.)

### Specification Tips

- Power module attaches to the front edge of the Riverbend components.
- Power modules cannot be daisy chained together.
- Application may require approval from local authority having jurisdiction (AHJ); ensure compliance before placing orders and installing.

### To Order, Specify:

1) Product number, including:

**1** Color:

**B** Black

**W** White

Description	Number <sup>1</sup>	Price
<b>6'(1829mm) Cord</b>		
One Simplex Outlet	EUSM-PFO <span style="background-color: #cccccc;">■</span> -1100	\$ 673.44
Two Simplex Outlets	EUSM-PFO <span style="background-color: #cccccc;">■</span> -2100	690.45
<b>12'(3658mm) Cord</b>		
One Simplex Outlet	EUSM-PLO <span style="background-color: #cccccc;">■</span> -1100	\$ 724.53
Two Simplex Outlets	EUSM-PLO <span style="background-color: #cccccc;">■</span> -2100	741.54

## Hardwire

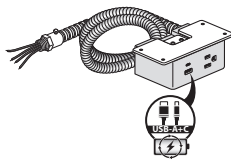

EUSM-HFOW-1100  
EUSM-HLOW-1100

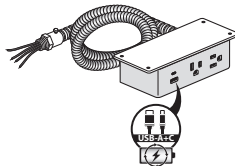

EUSM-HFOW-2100  
EUSM-HLOW-2100



Class QA

### Features

- Includes power module, two cord management clips, mounting brackets and attachment hardware.
- Power module consists of either one or two simplex outlets (NEMA-5-15R) and one dual USB A-C. (20W shared between A and C.)

### Specification Tips

- Power module attaches to the front edge of the Riverbend components.
- Power modules cannot be daisy chained together.
- Application may require approval from local authority having jurisdiction (AHJ); ensure compliance before placing orders and installing.

### To Order, Specify:

1) Product number, including:

**1** Color:

**B** Black

**W** White

Description	Number <sup>1</sup>	Price
<b>6'(1829mm) Cord</b>		
One Simplex Outlet	EUSM-HFO <span style="background-color: #cccccc;">■</span> -1100	\$ 801.32
Two Simplex Outlets	EUSM-HFO <span style="background-color: #cccccc;">■</span> -2100	818.33
<b>12'(3658mm) Cord</b>		
One Simplex Outlet	EUSM-HLO <span style="background-color: #cccccc;">■</span> -1100	\$852.41
Two Simplex Outlets	EUSM-HLO <span style="background-color: #cccccc;">■</span> -2100	869.42

# Openest Plume Screens

## Plume 3

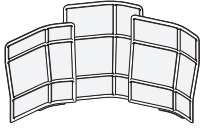

SON-3  
Class QA

### Features

- Includes:
  - (1) 57"(1448mm)H x 50"(1270mm)W screen,
  - (1) 65"(1651mm)H x 50"(1270mm)W screen,
  - (1) 61"(1549mm)H x 50"(1270mm)W screen.
- All screens are connected together, not interchangeable.
- Available in King II, Class II and Maya II fabrics only; COM not available.
- Floor support and screen connectors in same color.

### Dimensions

Height:	Depth:	Width:
H: 65"(1651mm)	D:34.5"(876mm)	W: 125.75"(3194mm) (Outside) 113.5"(2883mm) (Inside)

### To Order, Specify:

- Product number.
- Inner material.
- Outer Material.
- Trim color.

Number	Fabric	
	C	D
SON-3	\$14469.36	\$16695.40

## Plume 6

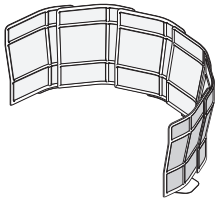

SON-6  
Class QA

### Features

- Includes:
  - (6) 57"(1448mm)H x 50"(1270mm)W screens.
- All screens are connected together, not interchangeable.
- Available in King II, Class II and Maya II fabrics only; COM not available.
- Floor support and screen connectors in same color.

### Dimensions

Height:	Depth:	Width:
H: 57"(1448mm)	D:84"(2134mm)	W: 143.75"(3651mm) (Outside) 132"(3353mm) (Inside)

### To Order, Specify:

- Product number.
- Inner material.
- Outer Material.
- Trim color.

Number	Fabric	
	C	D
SON-6	\$27825.61	\$31535.71

## Plume 9

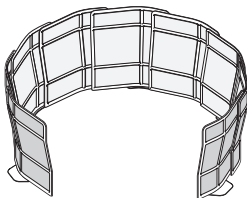

SON-9  
Class QA

### Features

- Includes:
  - (9) 57"(1448mm)H x 50"(1270mm)W screens.
- All screens are connected together, not interchangeable.
- Available in King II, Class II and Maya II fabrics only; COM not available.
- Floor support and screen connectors in same color.

### Dimensions

Height:	Depth:	Width:
H: 57"(1448mm)	D:128.5"(3264mm)	W: 146.75"(3727mm) (Outside) 131.25"(3334mm) (Inside)

### To Order, Specify:

- Product number.
- Inner material.
- Outer Material.
- Trim color.

Number	Fabric	
	C	D
SON-9	\$41738.50	\$46376.12

**Note:** For mixed grade fabric surfaces, pricing will be determined by the sum of the upcharges. Please refer to the electronic design and specification tools for these prices.

**Note:** The Openest Plume screen is made with polyester fabric adhered to a polyester core. The screen is compliant with UL-1286 flammability requirements and California Technical Bulletin TB-117-2013 requirements. The fabric covering is compliant with NFPA 701 requirements. Consult your local code authority to assure that screens are compliant prior to installation.

**Note:** For additional Openest products, details and specifications please refer to the Openest Price List.

# Openest Feather Sofa

## Feather – Symmetrical

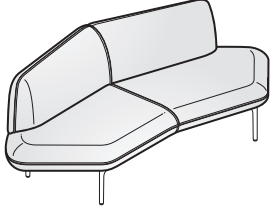

SOSS-1-RN  
Class QA

### Features

- Includes: Sofa with specifiable top-stitch thread.
- Legs: Painted cast aluminum.
- COM yardage: 6.5

### Specification Tips

- Fabric will be applied railroaded.
- Linear or patterned fabric is not recommended due to the manner in which fabric is applied.
- Designed for use by individuals up to 325 lbs.

### Dimensions

#### Sofa

Height:	Depth:	Width:
H: 30.25"(768mm)	D: 37"(940mm)	W: 87"(2210mm)
SH: 16.5"(419mm)	SD: 25"(635mm)	

### To Order, Specify:

1) Product number, including:

#### 1 Surface Material:

- 1 Leather
- 2 Fabric
- 3 Faux Leather

2) Surface color.

3) Thread color.

4) Leg color.

Number	Fabric									Leather	
	1	A	B	C	D	E	F	G	H	A	B
SOSS-1-N	\$5565.13	\$5880.49	\$6232.94	\$6492.65	\$7049.17	\$7327.41	\$7930.30	\$8115.81	\$10991.12	\$13217.19	

The following options require modification of the product number.

Stain Repellent

To specify, add **OP** to the end of the product number (add **\$276.94** list); **Example:** SOSS-2-NOP

## Feather – Asymmetrical

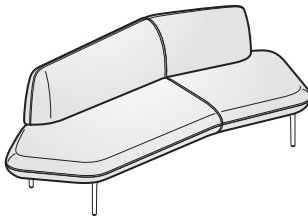

SOSR-1-RN  
Class QA

### Features

- Includes: Sofa with specifiable top-stitch thread.
- Legs: Painted cast aluminum.
- COM yardage: 6.75

### Specification Tips

- Fabric will be applied railroaded.
- Linear or patterned fabric is not recommended due to the manner in which fabric is applied.
- Handedness determined when seated on sofa.
- Designed for use by individuals up to 325 lbs.

### Dimensions

#### Sofa

Height:	Depth:	Width:
H: 30.25"(768mm)	D: 37"(940mm)	W: 92"(2337mm)
SH: 16.5"(419mm)	SD: 25"(635mm)	

### To Order, Specify:

1) Product number, including:

#### 1 Handedness:

- R Right hand
- L Left hand

#### 2 Surface Material:

- 1 Leather
- 2 Fabric
- 3 Faux Leather

2) Surface color.

3) Thread color.

4) Leg color.

Number	Fabric									Leather	
	1 2	A	B	C	D	E	F	G	H	A	B
SOS-1-N	\$5657.87	\$5991.79	\$6353.52	\$6724.51	\$7281.02	\$7605.68	\$8254.94	\$8394.08	\$1074.58	\$13356.30	

The following options require modification of the product number.

Stain Repellent

To specify, add **OP** to the end of the product number (add **\$276.94** list); **Example:** SOSR-2-NOP

**Note:** For additional Openest products, details and specifications please refer to the Openest Price List.

# Openest Chick Pouf

## Chick Pouf with Back

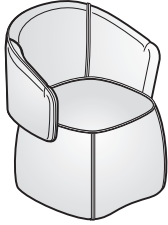

SOPB-2223  
Class QA

### Features

- Includes: Seat and back with specifiable top-stitch thread and puck colors.
- Seat back flips up and down.
- Pull tab to flip back up or down available in orange only.
- COM yardage:
  - Inner/Outer surfaces matching: 3.5
  - Inner Back and Seat only: 1.5
  - Outer Back and Base only: 2.0

### Specification Tips

- Linear or patterned fabric is not recommended due to the manner in which fabric is applied.
- Designed for use by individuals up to 325 lbs.

### Dimensions

Height: H: 37.85"(961mm)      Depth: D: 25.2"(640mm)      Width: W: 26"(660mm)  
 SH: 18"(457mm)      SD: 18.75"(476mm)

### To Order, Specify:

- Product number, including:
  - Inner Surface Material:**
    - Leather
    - Fabric
    - Faux Leather
  - Outer Surface Material:**
    - Leather
    - Fabric
    - Faux Leather
- Inner Surface Color (Seat, inside back).
- Outer Surface Color (Base, outer back).
- Thread color.
- Puck color.

Number ①②	Fabric							Leather		
	A	B	C	D	E	F	G	H	A	B
SOPB- 23-00H	\$3246.28	\$3431.78	\$3682.26	\$3914.14	\$4285.12	\$4479.92	\$4915.78	\$5054.96	\$6121.66	\$7281.02

## Chick Pouf without Back

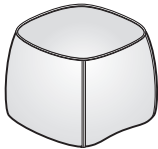

SOPH-2223  
Class QA

### Features

- Includes: Seat/Base only with specifiable top-stitch thread color.
- COM yardage:
  - Seat and Base matching: 2.0
  - Seat only: 0.75
  - Base only: 2.0

### Specification Tips

- Linear or patterned fabric is not recommended due to the manner in which fabric is applied.
- Designed for use by individuals up to 325 lbs.

### Dimensions

Height: H: 18"(457mm)      Depth: D: 22.5"(572mm)      Width: W: 23.25"(591mm)

### To Order, Specify:

- Product number, including:
  - Seat Surface Material:**
    - Leather
    - Fabric
    - Faux Leather
  - Base Surface Material:**
    - Leather
    - Fabric
    - Faux Leather
- Inner Surface Color (Seat).
- Outer Surface Color (Base).
- Thread color.

Number ①②	Fabric							Leather		
	A	B	C	D	E	F	G	H	A	B
SOPN- 23-00H	\$1567.52	\$1669.49	\$1827.17	\$1994.16	\$2216.72	\$2344.74	\$2643.40	\$2717.60	\$3616.06	\$4495.35

The following options require modification of the product number.

Stain Repellent

To specify, add **-P** to the end of the product number (add **\$139.39** list for Chick Pouf with Back or **\$79.67** for Chick Pouf without Back); **Example:** SOPB-2223-**P**; SOPN-2223-**P**

For mixed grade fabric surfaces, please refer to the electronic design and specification tools for these prices.

# Openest Chick Pouf

## Large Square – No Back

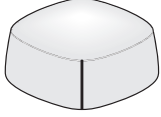

SOPN-2238  
Class QA

### Features

- Includes: Seat and base with specifiable top-stitch thread around the top and down the corners.
- Available with black hard or felt glides.
- COM yardage:  
 Seat and Base matching: 4.0  
 Seat only: 1.3  
 Base only: 2.6

### Specification Tips

- Fabric will be applied railroaded.
- Linear or patterned fabric is not recommended due to the manner in which fabric is applied.
- Designed for use by individuals up to 325 lbs.

### Dimensions

Height:                      Depth:                      Width:  
 H: 17"(432mm)              D: 38"(965mm)              W: 38"(965mm)

### To Order, Specify:

1) Product number, including:

#### 1 Seat Surface Material:

- 1 Leather
- 2 Fabric
- 3 Faux Leather

#### 2 Base Surface Material:

- 1 Leather
- 2 Fabric
- 3 Faux Leather

#### 3 Glide Option:

- H Hard Glides
- K Felt Glides

- 2) Seat surface color.  
 3) Base surface color.  
 4) Thread color.

Number	Fabric							Leather				
	1 2	3	A	B	C	D	E	F	G	H	A	B
SOPN- 38-00			\$2247.95	\$2397.82	\$2547.66	\$2703.80	\$2847.38	\$3521.80	\$3896.41	\$4570.83	\$4307.74	\$5032.06

## Rectangle – No Back

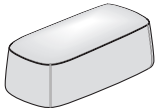

SOPN-2252  
Class QA

### Features

- Includes: Seat and base with specifiable top-stitch thread around the top and down the corners.
- Available with black hard or felt glides.
- COM yardage:  
 Seat and Base matching: 4.6  
 Seat only: 2.0  
 Base only: 2.6

### Specification Tips

- Fabric will be applied railroaded.
- Linear or patterned fabric is not recommended due to the manner in which fabric is applied.
- Designed for use by individuals up to 325 lbs.

### Dimensions

Height:                      Depth:                      Width:  
 H: 18"(457mm)              D: 27"(686mm)              W: 52"(1321mm)

### To Order, Specify:

1) Product number, including:

#### 1 Seat Surface Material:

- 1 Leather
- 2 Fabric
- 3 Faux Leather

#### 2 Base Surface Material:

- 1 Leather
- 2 Fabric
- 3 Faux Leather

#### 3 Glide Option:

- H Hard Glides
- K Felt Glides

- 2) Seat surface color.  
 3) Base surface color.  
 4) Thread color.

Number	Fabric							Leather			
	1 2	A	B	C	D	E	F	G	H	A	B
SOPN- 52-00		\$2647.58	\$2822.42	\$2997.24	\$3179.40	\$3346.95	\$4132.90	\$4570.77	\$5357.59	\$4837.23	\$5596.54

The following options require modification of the product number.

Stain Repellent

To specify, add **P** to the end of the product number (Large Square add **\$114.90** list; Rectangle add **\$134.87** list);

**Example:** SOPN-2238-00HP

For mixed grade fabric surfaces, please refer to the electronic design and specification tools for these prices.

# Openest Chick Pouf

## Round – No Back



SOPN-2265

### Features

- Includes: Seat and base with specifiable top-stitch thread around the top, across the middle of the top, and four vertical seams (every 90°).
- Available with black hard or felt glides or six black braking casters.
- Braking casters lock into place when weight is loaded on the pouf.
- COM yardage:
  - Seat and Base matching: 8.0
  - Seat only: 4.0
  - Base only: 4.0

### Specification Tips

- Fabric will be applied railroaded.
- Linear or patterned fabric is not recommended due to the manner in which fabric is applied.
- Designed for use by individuals up to 325 lbs.

### Dimensions

Height: H: 17"(432mm)      Depth: D: 65"(1651mm)

### To Order, Specify:

1) Product number, including:

**1 Seat Surface Material:**

- 2** Fabric
- 3** Faux Leather

**2 Base Surface Material:**

- 2** Fabric
- 3** Faux Leather

**3 Glide/Caster Option:**

- H** Hard Glides
- K** Felt Glides
- B** Braking Casters (add **\$585.17** list)

- 2) Seat surface color.
- 3) Base surface color.
- 4) Thread color.

Number	Fabric							Leather				
	1 2	3	A	B	C	D	E	F	G	H	A	B
SOPN- 65-00			\$4895.50	\$5195.22	\$5494.98	\$5807.16	\$6094.38	\$7443.14	\$8192.46	\$9541.22	N/A	N/A

The following options require modification of the product number.

Stain Repellent

To specify, add **P** to the end of the product number (add **\$229.80** list); **Example:** SOPN-2265-00HP

For mixed grade fabric surfaces, please refer to the electronic design and specification tools for these prices.

# Openest Sprig Tables

## Rectangle

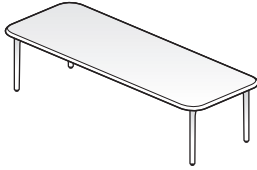

SORA-5320-P  
Class QA

### Features

- Includes: Table top and legs.
- Top available in Black or Polar painted MDF or planked wood in White Oak or Walnut.
- Planked wood tops are designed to be unique, using solid wood planks with a clear, low-gloss finish showing natural variation.
- Legs: Painted cast aluminum.

### To Order, Specify:

1) Product number, including:

**1 Surface Material:**

- P** Painted MDF
- W** Planked Wood

2) Top color.

3) Leg color.

Height	Depth	Width	Number ①	Painted	White Oak	Walnut
12"(305mm)	20"(508mm)	53"(1346mm)	SORA-5320-■	\$1539.70	\$3849.24	\$4683.99

## Round

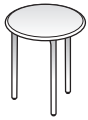

SODC-1616-P



SODB-2424-P  
Class QA

### Features

- Includes: Table top and legs.
- Top available in Black or Polar painted MDF or planked wood in White Oak or Walnut.
- Planked wood tops are designed to be unique, using solid wood planks with a clear, low-gloss finish showing natural variation.
- Legs: Painted cast aluminum.

### To Order, Specify:

1) Product number, including:

**1 Surface Material:**

- P** Painted MDF
- W** Planked Wood

2) Top color.

3) Leg color.

Height	Depth	Number ①	Painted	White Oak	Walnut
17"(432mm)	16"(406mm)	SODC-1616-■	\$1094.46	\$2226.04	\$ 2411.56
14"(356mm)	24"(610mm)	SODB-2424-■	\$1205.76	\$2986.62	\$3431.79

**Note:** For additional Openest products, details and specifications please refer to the Openest Price List.

# Poppy

## At-A-Glance

### Designer

Patricia Urquiola

### Fabric

Linear or patterned fabric not recommended due to the manner in which the material is applied.

Because of the nature of the chair, materials that have more fibers or woolen spun yarn construction, such as Cotswold, tend to upholster well on Poppy. Synthetic fibers, or textiles with heavy back coatings, tend to be more difficult to upholster and consequently may restrict some COMs.

### Specifications

Designed for use by individuals up to 325 lbs.

### Guest Seating

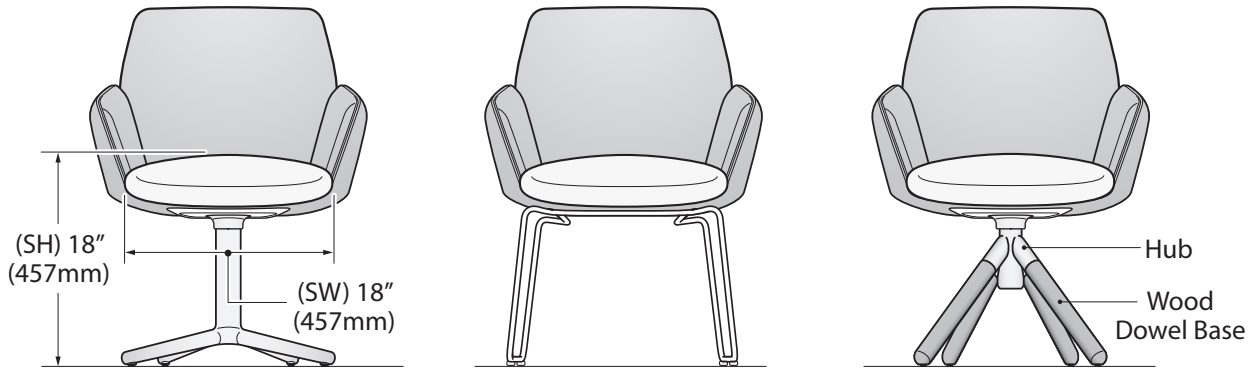

### Lounge Seating

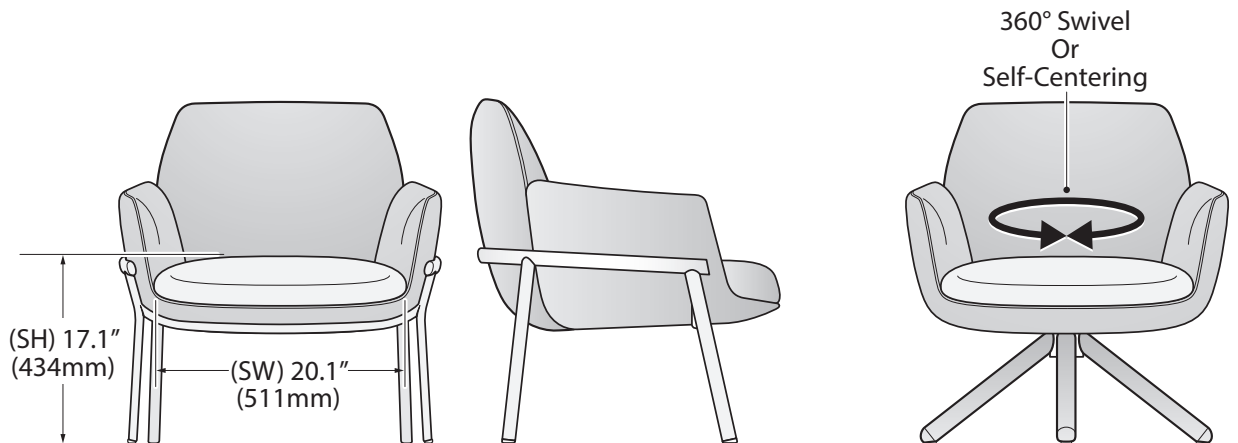

# Poppy

## Guest

### Four Star Base with Glides



SPG-11-4  
Class QA

#### Features

- Back and arms: Upholstered in matching upholstery.
- Seat: Standard upholstered. Upholstery can match or complement back and arms.
- Base: Four star aluminum base.
  - Standard with glides; felt pads included Available in Black (TR-F) or Smooth Plaster (TR-PLS)
- Seat swivels 360°.
- COM yardage / COL square footage: 2.0/55
  - Back/Arms: 1.5/40
  - Seat: 0.5/15
- Linear or patterned fabric is not recommended due to the manner in which fabric is applied.

#### Dimensions

Height:	Depth:	Width:
H: 33"(838mm)	D: 26.75"(679mm)	W: 26.75"(679mm)
SH: 18"(457mm)	SD: 18"(457mm)	SW: 18"(457mm)
AH: 25"(635mm)		

#### To Order, Specify:

1) Product number, including:

**1 Seat Upholstery:**

- 1** Leather
- 2** Fabric
- 3** Faux Leather

**2 Back/Arm Upholstery:**

- 1** Leather
- 2** Fabric
- 3** Faux Leather

- 2) Seat surface and color.  
 3) Back/arm surface and color.  
 4) Trim color.  
 TR-F Black  
 TR-PLS Smooth Plaster  
 (add **\$101.74** list)

Number <b>1 2</b>	Fabric								Leather	
	A	B	C	D	E	F	G	H	A	B
SPG- -4	\$2769.36	\$2893.62	\$3000.10	\$3151.06	\$3328.58	\$3417.31	\$3461.68	\$3550.44	\$3488.33	\$3683.58



# Poppy

## Guest

### Sled Base



SPG-11-7  
Class QA – Open Market

#### Features

- Back and arms: Upholstered in matching upholstery.
- Seat: Standard upholstered. Upholstery can match or complement back and arms.
- Base: Sled base painted in Black (TR-F) or Smooth Plaster (TR-PLS).
- Glides: Available in felt or hard plastic.
- COM yardage / COL square footage: 2.0/55  
Back/Arms: 1.5/40  
Seat: 0.5/15

#### Dimensions

Height:	Depth:	Width:
H: 33"(838mm)	D: 24.25"(616mm)	W: 24.25"(616mm)
SH: 18"(457mm)	SD: 18"(457mm)	SW: 18"(457mm)
AH: 25"(635mm)		

#### To Order, Specify:

1) Product number, including:

##### 1 Seat Upholstery:

- 1 Leather
- 2 Fabric
- 3 Faux Leather

##### 2 Back/Arm Upholstery:

- 1 Leather
- 2 Fabric
- 3 Faux Leather

##### 3 Glide Styles:

- 7 Hard
- 8 Felt

- 2) Seat surface and color.
- 3) Back/arm surface and color.
- 4) Trim color.  
TR-F Black  
TR-PLS Smooth Plaster  
(add **\$101.74** list)

Number	Fabric								Leather		
	1 2 3	A	B	C	D	E	F	G	H	A	B
SPG-■■■-■		\$2319.10	\$2443.36	\$2549.84	\$2700.80	\$2878.32	\$2967.05	\$3011.42	\$3100.18	\$3038.07	\$3233.32

### Wood Base



SPG-11-W  
Class QA

#### Features

- Back and arms: Upholstered in matching upholstery.
- Seat: Standard upholstered. Upholstery can match or complement back and arms.
- Base: Wooden dowel legs with painted aluminum hub.  
–Wooden Legs available in Clear on Oak (M5-W35), Clear on Walnut (M6-W35) and Ink on Ash (M7-W43)  
–Wooden Legs standard with glides; felt pads included  
–Hub available in Black (TR-F) or Smooth Plaster (TR-PLS)
- Seat swivels 360°.
- COM yardage / COL square footage: 2.0/55  
Back/Arms: 1.5/40  
Seat: 0.5/15

#### Specification Tip

- Linear or patterned fabric is not recommended due to the manner in which fabric is applied.

#### Dimensions

Height:	Depth:	Width:
H: 33"(838mm)	D: 24.25"(616mm)	W: 24.25"(616mm)
SH: 18"(457mm)	SD: 18"(457mm)	SW: 18"(457mm)
AH: 25"(635mm)		

#### To Order, Specify:

1) Product number, including:

##### 1 Seat Upholstery:

- 1 Leather
- 2 Fabric
- 3 Faux Leather

##### 2 Back/Arm Upholstery:

- 1 Leather
- 2 Fabric
- 3 Faux Leather

- 2) Seat surface and color.
- 3) Back/arm surface and color.
- 4) Trim color.  
TR-F Black  
TR-PLS Smooth Plaster  
(add **\$73.99** list)
- 5) Wood finish.

Description	Number	Fabric								Leather		
		1 2	A	B	C	D	E	F	G	H	A	B
Ink on Ash	SPG-■■■-W		\$3594.88	\$ 3719.14	\$3825.62	\$3976.58	\$ 4154.10	\$4242.83	\$ 4287.20	\$4375.96	\$ 4313.85	\$4509.10
Clear on Oak	SPG-■■■-W		3648.13	3772.39	3878.87	4029.83	4207.35	4296.08	4340.45	4429.21	4367.10	4562.35
Clear on Walnut	SPG-■■■-W		3665.92	3790.18	3896.66	4047.62	4225.14	4313.87	4358.24	4447.00	4384.89	4580.14

The following options require modification of the product number.

Stain Repellent

To specify, add **P** to the end of the product number (add **\$109.11** list); **Example:** SPG-22-WP

# Poppy Lounge

## Basket



SLP-22-T  
Class QA

### Features

- Back and arms: Upholstered in matching upholstery.
- Seat: Upholstery can match or complement back and arms.
- Base: Four leg painted steel basket frame.  
-Available in Black (TR-F), Smooth Plaster (TR-PLS), Sable (TR-1M) or Rusty Red (TR-RR).
- Glides: Available in felt or hard plastic.
- COM yardage / COL square footage: 4.0/72  
Back/Arms: 3.0/54  
Seat: 1.0/18

### Specification Tip

- Linear or patterned fabric is not recommended due to the manner in which fabric is applied.

### Dimensions

Height:	Depth:	Width:
H: 32.6"(828mm)	D: 29.4"(747mm)	W: 31"(787mm)
SH: 17.1"(434mm)	SD: 20.5"(521mm)	SW: 20.1"(511mm)
AH: 24"(610mm)		

### To Order, Specify:

1) Product number, including:

#### 1 Seat Upholstery:

- 1 Leather
- 2 Fabric
- 3 Faux Leather

#### 2 Back/Arm Upholstery:

- 1 Leather
- 2 Fabric
- 3 Faux Leather

#### 3 Glide Style:

- F Felt
- H Hard

- 2) Seat surface and color.  
3) Back/arm surface and color.  
4) Trim color.  
TR-F Black  
TR-1M Sable  
TR-RR Rusty Red  
TR-PLS Smooth Plaster  
(add **\$98.75** list)

Number	Fabric							Leather			
	1 2 3	A	B	C	D	E	F	G	H	A	B
SLP- - -T -		\$3940.78	\$4165.21	\$4371.68	\$4667.86	\$4928.23	\$5924.65	\$6517.09	\$7594.29	\$8213.71	\$10018.09

## Swivel



SLP-22-S  
SLP-22-R  
Class QA

### Features

- Back and arms: Upholstered in matching upholstery.
- Seat: Upholstery can match or complement back and arms.
- Base: Four wooden dowel legs.  
-Legs available in Clear on Oak (M5-W35), Clear on Walnut (M6-W35) and Ink on Ash (M7-W43).
- Available with 360° or self-centering swivel base.
- Glides: Available in felt or hard plastic.
- COM yardage / COL square footage: 4.0/72  
Back/Arms: 3.0/54  
Seat: 1.0/18

### Specification Tip

- Linear or patterned fabric is not recommended due to the manner in which fabric is applied.

### Dimensions

Height:	Depth:	Width:
H: 32.6"(828mm)	D: 29.4"(747mm)	W: 31"(787mm)
SH: 17.1"(434mm)	SD: 20.5"(521mm)	SW: 20.1"(511mm)
AH: 24"(610mm)		

### To Order, Specify:

#### 1 Seat Upholstery:

- 1 Leather
- 2 Fabric
- 3 Faux Leather

#### 2 Back/Arm Upholstery:

- 1 Leather
- 2 Fabric
- 3 Faux Leather

#### 3 Glide Style:

- F Felt
- H Hard

- 2) Seat surface and color.  
3) Back/arm surface and color.  
4) Wood finish

Description	Number	Fabric							Leather			
		1 2 3	A	B	C	D	E	F	G	H	A	B
<b>360° Swivel Base</b>												
Ink on Ash	SLP- - -S -		\$4766.63	\$ 4991.06	\$ 5197.53	\$5493.71	\$ 5754.08	\$ 6750.50	\$ 7342.94	\$ 8420.14	\$ 9039.56	\$10843.94
Clear on Oak	SLP- - -S -		4820.50	5044.93	5251.40	5547.58	5807.95	6804.37	7396.81	8474.01	9093.43	10897.81
Clear on Walnut	SLP- - -S -		4910.29	5134.72	5341.19	5637.37	5897.74	6894.16	7486.60	8563.80	9183.22	10987.60
<b>Self-Centering Base</b>												
Ink on Ash	SLP- - -R -		\$ 4811.51	\$5035.94	\$5242.41	\$5538.59	\$ 5798.96	\$ 6795.38	\$ 7387.82	\$ 8465.02	\$ 9084.44	\$10888.82
Clear on Oak	SLP- - -R -		4865.38	5089.81	5296.28	5592.46	5852.83	6849.25	7441.69	8518.89	9138.31	10942.69
Clear on Walnut	SLP- - -R -		4955.17	5179.60	5386.07	5682.25	5942.62	6939.04	7531.48	8608.68	9228.10	11032.48

The following options require modification of the product number.

Stain repellent

To specify, add **P** to end of the product number (add **\$165.17** list); **Example:** SLP-22-TFP

**Note:** For mixed grade fabrics on seat and back please refer to the electronic design and specification tools for pricing.

# Wyn

## At-A-Glance

### Designer

Brad Ascalon

### Awards/ Achievements

2024 Best of Neocon Innovation award  
2024 HiP finalist for the Lounge category

### Wyn

Wyn is an active lounge chair that bridges the gap between lounge chairs and conference seating with comfort and movement.

### Specifications

Designed for use by individuals up to 325 lbs.

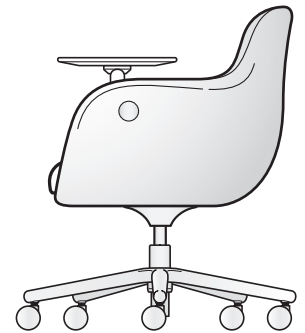
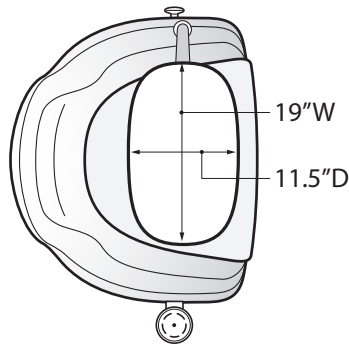
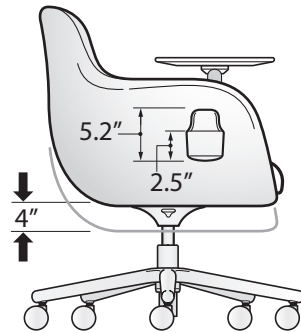
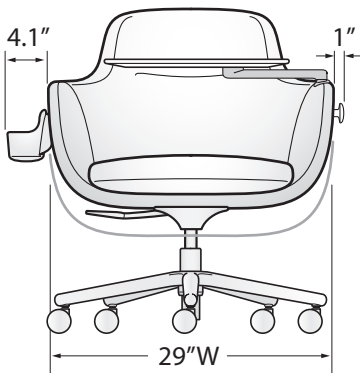
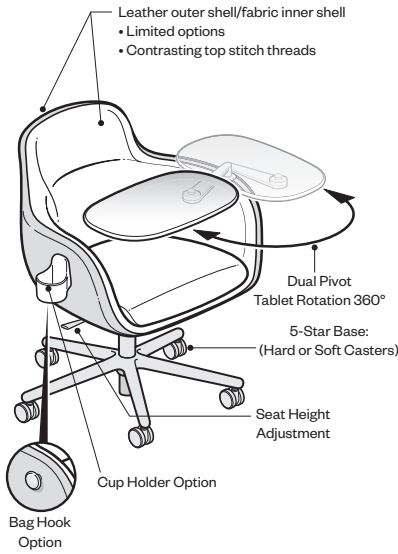

# Wyn

## At-A-Glance

### Catalog Logic

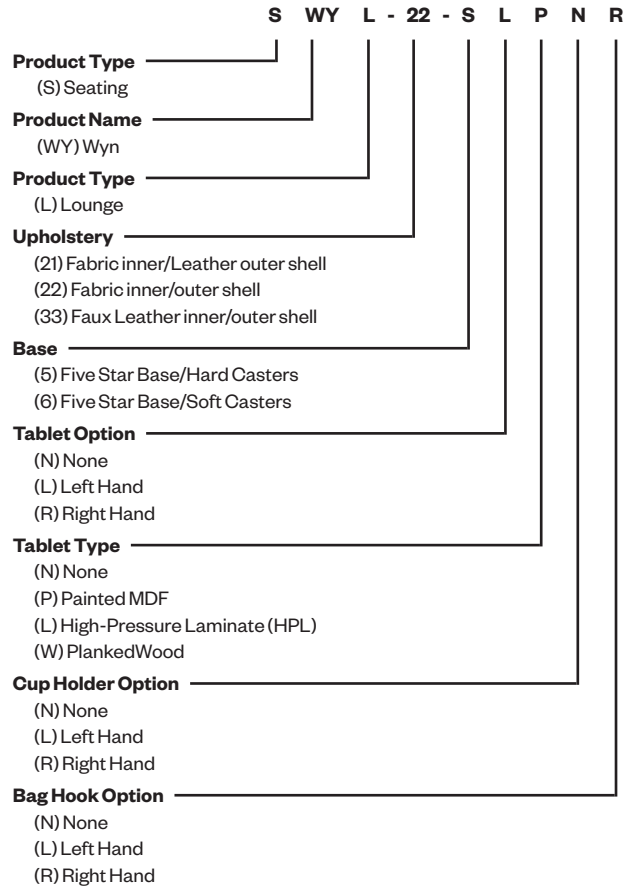

# Wyn

## Lounge Chair



Bag Hook Option

SWYL  
Class QA0

### Features

- Includes upholstered chair with five-star aluminum base on hard or soft casters. Optional tablet arm, cup holder and bag hook available.
- Fabric or Faux Leather option will have matching inner and outer shell.
- Dual-upholstery option will have fabric inner shell and Nature Leather outer shell with contrasting top stitch thread. Limited combinations noted in chart below.
- Base: Five star aluminum base on casters.
  - Available in Black (TR-F) or Smooth Plaster (TR-UPLS).
  - Hard casters match base color; Smooth Plaster casters have a graphite tread.
  - Soft casters available in black only.
- Pneumatic height adjustment of 4"(102mm).
- Tablet option:
  - Tablet arm available right or left handed.
  - Dual pivot table rotates 360° at both the arm's pivot joint and tablet surface connection point.
  - Tablet surface is 11.5"(292mm)D x 19"(483mm)W x 0.75"(19mm) thick.
  - Tablet surface available in:
    - Painted MDF in Black PW-F or Polar PW-PL.
    - High-Pressure Laminate (HPL) in Charcoal H-8J, Landmark H-KM, Linen H-WL or Neo Walnut H-KL.
    - Planked Wood in White Oak VB-W35 or Walnut VH-W35.
- Cup Holder option:
  - Available right or left handed.
  - Molded plastic.
  - Total height is 5.2"(132mm). Cup holder portion is 2.5"(64mm) H.
  - Inside diameter is 3.2"(81mm) at the bottom and 3.5"(89mm) at the top.
- Bag Hook option:
  - Available right or left handed.
  - Maximum weight limit is 30 lbs.
  - Molded plastic.
  - 2"(51mm) diameter
- COM yardage: 2.5

### Specification Tips

- When specifying both Cup Holder and Bag Hook they must be specified on opposite sides. Cup Holder and Bag Hook cannot be on the same side.
- Cup Holder option may not be specified on same side as the tablet arm.

### Dimensions

Height: 33-37" (838-940mm)  
 Depth: 25"(635mm) SD: 17.5"(445mm)  
 Width: 29"(737mm)\*\* SW: 15.6"(396mm)  
 SH: 16-20" (406-508mm)  
 AH: 26-31" (660-787mm)

\*Measurements taken with the BIFMA chair measuring device.

\*\* Width measurement is without accessories.

### Dual-Upholstery Options

Inner Shell Material		Corresponding Nature Leather Outer Shell	
Code	Pattern/Color	Code	Color
NV-E	Clara 2/244	XE-AJ	Cream
NV-J	Clara 2/384	XE-AR	Bittersweet
JB-SC	Cotswold/Charcoal	XE-AK	Ink
JB-SU	Cotswold/Silverbush	XE-AL	Shadow
JB-SD	Cotswold/Silver Dollar	XE-AN	White
JB-TR	Cotswold/Tree	XE-AS	Bark
SZ-110	Hallingdal 65/110	XE-AM	Seal
SZ-116	Hallingdal 65/116	XE-AH	Flint
6M-AR	Main Line Flax/Archway	XE-AT	Saddle
6M-BN	Main Line Flax/Bank	XE-AW	Truffle
S7-H	Melange Nap/241	XE-AP	Chocolate

### To Order, Specify:

1) Product number, including:

**1 Upholstery (see restrictions below):**

- 21** Leather
- 22** Fabric
- 33** Faux Leather

- 2) Upholstery.
- 3) Base color.  
TR-F Black  
TR-UPLS Smooth Plaster (add **\$24.61** list)
- 4) Tablet surface color (if applicable).
- 5) Tablet arm trim color (if applicable).  
TR-F Black  
TR-UPLS Smooth Plaster (add **\$24.61** list)
- 6) Cup Holder color (if applicable).  
TR-F Black  
TR-UPLS Smooth Plaster (add **\$24.61** list)
- 7) Bag Hook color (if applicable).  
TR-F Black  
TR-UPLS Smooth Plaster (add **\$24.61** list)

# Wyn

## Lounge Chair

Cup Holder	Bag Hook	Number ①②	Fabric					Leather			
			A	B	C	D	E		F	G	H
<b>No Tablet</b>											
None	None	SWYL- ■ ■ -5NNNN	\$ 3541.70	\$ 3746.34	\$ 3814.55	\$ 3882.76	\$ 4087.40	\$ 4292.04	\$ 4496.68	\$ 4905.95	\$ 5923.52
	Right-Hand	SWYL- ■ ■ -5NNNR	3645.49	3850.13	3918.34	3986.55	4191.19	4395.83	4600.47	5009.74	6027.31
	Left-Hand	SWYL- ■ ■ -5NNNL	3645.49	3850.13	3918.34	3986.55	4191.19	4395.83	4600.47	5009.74	6027.31
Right-Hand	None	SWYL- ■ ■ -5NNRN	\$3645.49	\$3850.13	\$ 3918.34	\$ 3986.55	\$ 4191.19	\$ 4395.83	\$ 4600.47	\$ 5009.74	\$ 6027.31
	Left-Hand	SWYL- ■ ■ -5NNRL	3749.28	3953.92	4022.13	4090.34	4294.98	4499.62	4704.26	5113.53	6131.10
Left-Hand	None	SWYL- ■ ■ -5NNLN	\$3645.49	\$3850.13	\$ 3918.34	\$ 3986.55	\$ 4191.19	\$ 4395.83	\$ 4600.47	\$ 5009.74	\$ 6027.31
	Right-Hand	SWYL- ■ ■ -5NNLR	3749.28	3953.92	4022.13	4090.34	4294.98	4499.62	4704.26	5113.53	6131.10
<b>Tablet - Painted MDF - Left Hand</b>											
None	None	SWYL- ■ ■ -5LPNN	\$ 4207.24	\$ 4411.88	\$ 4480.09	\$ 4548.30	\$ 4752.94	\$ 4957.58	\$ 5162.22	\$ 5571.49	\$ 6589.06
	Left-Hand	SWYL- ■ ■ -5LPNL	4311.03	4515.67	4583.88	4652.09	4856.73	5061.37	5266.01	5675.28	6692.85
	Right-Hand	SWYL- ■ ■ -5LPNR	4311.03	4515.67	4583.88	4652.09	4856.73	5061.37	5266.01	5675.28	6692.85
Right-Hand	None	SWYL- ■ ■ -5LPRN	\$ 4311.03	\$ 4515.67	\$ 4583.88	\$ 4652.09	\$ 4856.73	\$ 5061.37	\$ 5266.01	\$ 5675.28	\$ 6692.85
	Left-Hand	SWYL- ■ ■ -5LPRL	4414.82	4619.46	4687.67	4755.88	4960.52	5165.16	5369.80	5779.07	6796.64
<b>Tablet - Painted MDF - Right Hand</b>											
None	None	SWYL- ■ ■ -5RPNN	\$ 4207.24	\$ 4411.88	\$ 4480.09	\$ 4548.30	\$ 4752.94	\$ 4957.58	\$ 5162.22	\$ 5571.49	\$ 6589.06
	Left-Hand	SWYL- ■ ■ -5RPNL	4311.03	4515.67	4583.88	4652.09	4856.73	5061.37	5266.01	5675.28	6692.85
	Right-Hand	SWYL- ■ ■ -5RPNR	4311.03	4515.67	4583.88	4652.09	4856.73	5061.37	5266.01	5675.28	6692.85
Left-Hand	None	SWYL- ■ ■ -5RPLN	\$ 4311.03	\$ 4515.67	\$ 4583.88	\$ 4652.09	\$ 4856.73	\$ 5061.37	\$ 5266.01	\$ 5675.28	\$ 6692.85
	Right-Hand	SWYL- ■ ■ -5RPLR	4414.82	4619.46	4687.67	4755.88	4960.52	5165.16	5369.80	5779.07	6796.64
<b>Tablet - HPL A - Left Hand</b>											
None	None	SWYL- ■ ■ -5LLNN	\$ 4431.94	\$ 4636.58	\$ 4704.79	\$ 4773.00	\$ 4977.64	\$ 5182.28	\$ 5386.92	\$ 5796.19	\$ 6813.76
	Left-Hand	SWYL- ■ ■ -5LLNL	4535.73	4740.37	4808.58	4876.79	5081.43	5286.07	5490.71	5899.98	6917.55
	Right-Hand	SWYL- ■ ■ -5LLNR	4535.73	4740.37	4808.58	4876.79	5081.43	5286.07	5490.71	5899.98	6917.55
Right-Hand	None	SWYL- ■ ■ -5LLRN	\$ 4535.73	\$ 4740.37	\$ 4808.58	\$ 4876.79	\$ 5081.43	\$ 5286.07	\$ 5490.71	\$ 5899.98	\$ 6917.55
	Left-Hand	SWYL- ■ ■ -5LLRL	4639.52	4844.16	4912.37	4980.58	5185.22	5389.86	5594.50	6003.77	7021.34
<b>Tablet - HPL B - Left Hand</b>											
None	None	SWYL- ■ ■ -5LLNN	\$ 4447.99	\$ 4652.63	\$ 4720.84	\$ 4789.05	\$ 4993.69	\$ 5198.33	\$ 5402.97	\$ 5812.24	\$ 6829.81
	Left-Hand	SWYL- ■ ■ -5LLNL	4551.78	4756.42	4824.63	4892.84	5097.48	5302.12	5506.76	5916.03	6933.60
	Right-Hand	SWYL- ■ ■ -5LLNR	4551.78	4756.42	4824.63	4892.84	5097.48	5302.12	5506.76	5916.03	6933.60
Right-Hand	None	SWYL- ■ ■ -5LLRN	\$ 4551.78	\$ 4756.42	\$ 4824.63	\$ 4892.84	\$ 5097.48	\$ 5302.12	\$ 5506.76	\$ 5916.03	\$ 6933.60
	Left-Hand	SWYL- ■ ■ -5LLRL	4655.57	4860.21	4928.42	4996.63	5201.27	5405.91	5610.55	6019.82	7037.39
<b>Tablet - HPL A - Right Hand</b>											
None	None	SWYL- ■ ■ -5RLNN	\$ 4431.94	\$ 4636.58	\$ 4704.79	\$ 4773.00	\$ 4977.64	\$ 5182.28	\$ 5386.92	\$ 5796.19	\$ 6813.76
	Left-Hand	SWYL- ■ ■ -5RLNL	4535.73	4740.37	4808.58	4876.79	5081.43	5286.07	5490.71	5899.98	6917.55
	Right-Hand	SWYL- ■ ■ -5RLNR	4535.73	4740.37	4808.58	4876.79	5081.43	5286.07	5490.71	5899.98	6917.55
Left-Hand	None	SWYL- ■ ■ -5RLLN	\$ 4535.73	\$ 4740.37	\$ 4808.58	\$ 4876.79	\$ 5081.43	\$ 5286.07	\$ 5490.71	\$ 5899.98	\$ 6917.55
	Right-Hand	SWYL- ■ ■ -5RLLR	4639.52	4844.16	4912.37	4980.58	5185.22	5389.86	5594.50	6003.77	7021.34
<b>Tablet - HPL B - Right Hand</b>											
None	None	SWYL- ■ ■ -5RLNN	\$ 4447.99	\$ 4652.63	\$ 4720.84	\$ 4789.05	\$ 4993.69	\$ 5198.33	\$ 5402.97	\$ 5812.24	\$ 6829.81
	Left-Hand	SWYL- ■ ■ -5RLNL	4551.78	4756.42	4824.63	4892.84	5097.48	5302.12	5506.76	5916.03	6933.60
	Right-Hand	SWYL- ■ ■ -5RLNR	4551.78	4756.42	4824.63	4892.84	5097.48	5302.12	5506.76	5916.03	6933.60
Left-Hand	None	SWYL- ■ ■ -5RLLN	\$ 4551.78	\$ 4756.42	\$ 4824.63	\$ 4892.84	\$ 5097.48	\$ 5302.12	\$ 5506.76	\$ 5916.03	\$ 6933.60
	Right-Hand	SWYL- ■ ■ -5RLLR	4655.57	4860.21	4928.42	4996.63	5201.27	5405.91	5610.55	6019.82	7037.39

# Wyn

## Lounge Chair

Cup Holder	Bag Hook	Number ①②	Fabric								Leather
			A	B	C	D	E	F	G	H	
<b>Tablet - Wood - White Oak - Left Hand</b>											
None	None	SWYL-■-5LWNN	\$5209.83	\$ 5414.47	\$5482.68	\$5550.89	\$ 5755.53	\$5960.17	\$ 6164.81	\$6574.08	\$ 7591.65
	Left-Hand	SWYL-■-5LWNL	5313.62	5518.26	5586.47	5654.68	5859.32	6063.96	6268.60	6677.87	7695.44
	Right-Hand	SWYL-■-5LWNR	5313.62	5518.26	5586.47	5654.68	5859.32	6063.96	6268.60	6677.87	7695.44
Right-Hand	None	SWYL-■-5LWRN	\$ 5313.62	\$ 5518.26	\$5586.47	\$5654.68	\$5859.32	\$6063.96	\$6268.60	\$6677.87	\$7695.44
	Left-Hand	SWYL-■-5LWRL	5417.41	5622.05	5690.26	5758.47	5963.11	6167.75	6372.39	6781.66	7799.23
<b>Tablet - Wood - Walnut - Left Hand</b>											
None	None	SWYL-■-5LWNN	\$ 5274.03	\$5478.67	\$5546.88	\$ 5615.09	\$ 5819.73	\$6024.37	\$6229.01	\$6638.28	\$7655.85
	Left-Hand	SWYL-■-5LWNL	5377.82	5582.46	5650.67	5718.88	5923.52	6128.16	6332.80	6742.07	7759.64
	Right-Hand	SWYL-■-5LWNR	5377.82	5582.46	5650.67	5718.88	5923.52	6128.16	6332.80	6742.07	7759.64
Right-Hand	None	SWYL-■-5LWRN	\$ 5377.82	\$5582.46	\$5650.67	\$ 5718.88	\$5923.52	\$ 6128.16	\$6332.80	\$6742.07	\$7759.64
	Left-Hand	SWYL-■-5LWRL	5481.61	5686.25	5754.46	5822.67	6027.31	6231.95	6436.59	6845.86	7863.43
<b>Tablet - Wood - White Oak - Right Hand</b>											
None	None	SWYL-■-5RWNN	\$5209.83	\$ 5414.47	\$5482.68	\$5550.89	\$ 5755.53	\$5960.17	\$ 6164.81	\$6574.08	\$ 7591.65
	Left-Hand	SWYL-■-5RWNL	5313.62	5518.26	5586.47	5654.68	5859.32	6063.96	6268.60	6677.87	7695.44
	Right-Hand	SWYL-■-5RWNR	5313.62	5518.26	5586.47	5654.68	5859.32	6063.96	6268.60	6677.87	7695.44
Left-Hand	None	SWYL-■-5RWLN	\$ 5313.62	\$ 5518.26	\$5586.47	\$5654.68	\$5859.32	\$6063.96	\$6268.60	\$6677.87	\$7695.44
	Right-Hand	SWYL-■-5RWLR	5417.41	5622.05	5690.26	5758.47	5963.11	6167.75	6372.39	6781.66	7799.23
<b>Tablet - Wood - Walnut - Right Hand</b>											
None	None	SWYL-■-5RWNN	\$ 5274.03	\$5478.67	\$5546.88	\$ 5615.09	\$ 5819.73	\$6024.37	\$6229.01	\$6638.28	\$7655.85
	Left-Hand	SWYL-■-5RWNL	5377.82	5582.46	5650.67	5718.88	5923.52	6128.16	6332.80	6742.07	7759.64
	Right-Hand	SWYL-■-5RWNR	5377.82	5582.46	5650.67	5718.88	5923.52	6128.16	6332.80	6742.07	7759.64
Left-Hand	None	SWYL-■-5RWLN	\$ 5377.82	\$5582.46	\$5650.67	\$ 5718.88	\$5923.52	\$ 6128.16	\$6332.80	\$6742.07	\$7759.64
	Right-Hand	SWYL-■-5RWLR	5481.61	5686.25	5754.46	5822.67	6027.31	6231.95	6436.59	6845.86	7863.43

The following options require modification of the product number.

Soft Casters  
Stain repellent

To specify, change the 7th digit in the product number to a **6** (add **\$70.41** list); **Example:** SWYL-22-6RPNN  
To specify, add **P** to the end of the product number (add **\$160.35** list); **Example:** SWYL-22-5RPNNP

# Cardigan Lounge

## Chair



CDSL-UU  
Class QA

### Features

- Includes one chair with digitally knit seat and back.
- Back: One piece digital knit material.
- Seat: One piece digital knit material covering Biomass balanced foam cushion.
- Painted steel frame.
- Glides - hard and soft glides included.

### Specification Tips

- Seat and back must be same color.
- Assembly required; Hardware and tool provided.
- COM not available.
- Shipping weight: 48.5 lbs. (includes chair and box).
- Packaging dimensions: 39.4"(1001mm) x 22"(559mm) x 17.3"(439mm).
- Designed for use by individuals up to 325 lbs.

### Dimensions

Height:	Depth:	Width:
H: 36.7"(932mm)	D: 32.2"(818mm)	W: 38.3"(973mm)
SH: 17.7"(450mm)*	SD: 24"(610mm)*	SW: 29"(737mm)*

\*Measurements taken with the BIFMA chair measuring device.

### To Order, Specify:

- 1) Product number.
- 2) Seat knit color.
- 3) Base knit color.
- 4) Frame color

	Number	Price
	CDSL-UU	\$2012.43

## Pillow



CDSL-UU  
Class QA

### Features

- Includes one pillow.
- Available in knit materials matching Haworth Cardigan Lounge seating.

### To Order, Specify:

- 1) Product number.
- 2) Knit color.

Depth	Width	Number	Price
11.8"(300mm)	17.7"(450mm)	CDSP-R	\$275.52

# Hello Lounge

## At-A-Glance

### Catalog Logic

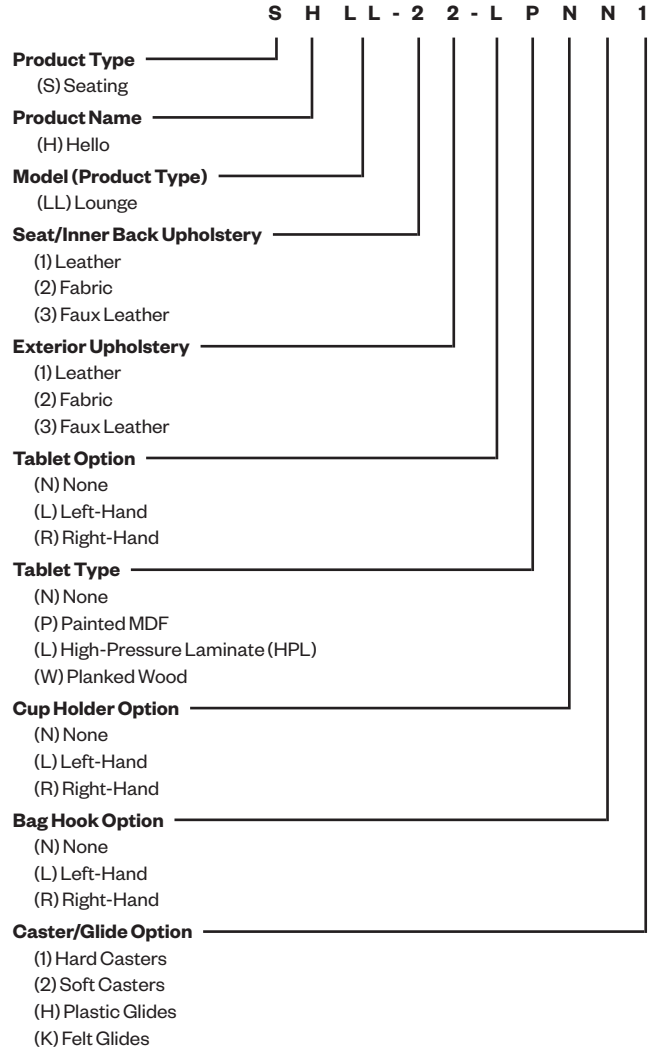

### Specifications

Designed for use by individuals up to 325 lbs.

# Hello Lounge Chair

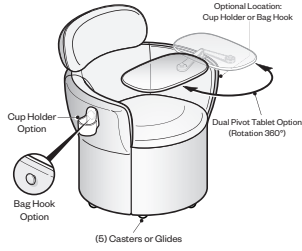

SHLL  
Class QAO

## Features

- Includes one fully upholstered 360° swivel lounge chair on glides or casters. Optional tablet arm, bag hook or cup holder available.
- Concealed casters or glides in black only.
- Tablet options:
  - Tablet arm available left- or right-handed.
  - Dual pivot tablet rotates 360° at both the arm's pivot joint and tablet surface connection point.
  - Tablet surface is 11.5" (292mm) D x 19" (483mm) W x 0.75" (19mm) thick.
  - Tablet surface available in:
    - Painted MDF in Black (PW-F) or Polar (PW-PL).
    - High-Pressure Laminate (HPL) in Charcoal (H-8J), Landmark (H-KM) Linen (H-WL) or Neo Walnut (H-KL).
    - Planked wood in White Oak (VB-W35) or Walnut (VH-W35).
- Cup Holder options:
  - Available left- or right-handed.
  - Molded plastic.
  - Total height is 5.2" (132mm). Cup holder portion is 2.5" (64mm) H.
  - Inside diameter is 3.2" (81mm) at the bottom and 3.5" (89mm) at the top.
- Bag Hook options:
  - Available left- or right-handed.
  - Molded plastic.
  - 2" (51mm) diameter.
  - Maximum weight limit is 30 lbs.
- COM Yardage / COL square footage:
  - Seat/Inner Back: 1.5 / 16
  - Exterior: 3.0 / 38

## Specification Tips

- When specifying both Cup Holder and Bag Hook they must be specified on opposite sides. Cup Holder and Bag Hook cannot be on the same side.
- Cup Holder option may not be specified on the same side as the tablet arm.

## Dimensions

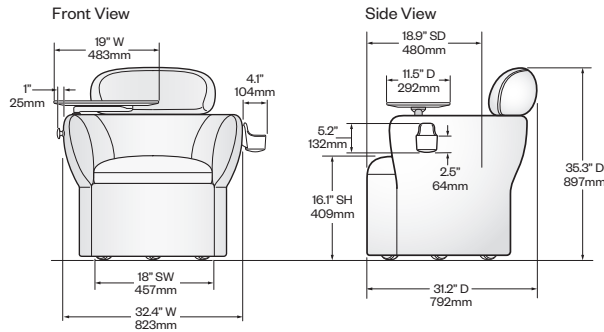

## To Order, Specify:

1) Product number, including:

### 1 Seat/Inner Back Upholstery:

- 1 Leather
- 2 Fabric
- 3 Faux Leather

### 2 Exterior Upholstery:

- 1 Leather
- 2 Fabric
- 3 Faux Leather

### 3 Caster/Glide Option:

- 1 Hard Casters
- 2 Soft Casters
- H Plastic Glides
- K Felt Glides

2) Seat/Inner Back material.

3) Exterior material.

4) Tablet surface material/color (if applicable).

5) Tablet arm trim color<sup>1</sup> (if applicable).

6) Cup Holder color<sup>1</sup> (if applicable).

7) Bag Hook color<sup>1</sup> (if applicable).

<sup>1</sup> TR-F Black

TR-UPLS Smooth Plaster (add \$24.61 list)

# Hello Lounge Chair

Cup Holder	Bag Hook	Number ①②	③	Fabric						Leather			
				A	B	C	D	E	F	G	H	A	B
<b>No Tablet</b>													
None	None	SHLL-	-NNNN	\$3589.55	\$3859.32	\$4129.09	\$4398.86	\$5208.18	\$6017.50	\$6826.82	\$8445.47	\$5772.88	\$6077.51
	Left-Hand	SHLL-	-NNNL	3693.34	3963.11	4232.88	4502.65	5311.97	6121.29	6930.61	8549.26	5876.67	6181.30
	Right-Hand	SHLL-	-NNNR	3693.34	3963.11	4232.88	4502.65	5311.97	6121.29	6930.61	8549.26	5876.67	6181.30
Right-Hand	None	SHLL-	-NNRN	3693.34	3963.11	4232.88	4502.65	5311.97	6121.29	6930.61	8549.26	5876.67	6181.30
	Left-Hand	SHLL-	-NNRL	3797.13	4066.90	4336.67	4606.44	5415.76	6225.08	7034.40	8653.05	5980.46	6285.09
Left-Hand	None	SHLL-	-NNLN	3693.34	3963.11	4232.88	4502.65	5311.97	6121.29	6930.61	8549.26	5876.67	6181.30
	Right-Hand	SHLL-	-NNLR	3797.13	4066.90	4336.67	4606.44	5415.76	6225.08	7034.40	8653.05	5980.46	6285.09
<b>Tablet - Painted MDF - Left-Hand</b>													
None	None	SHLL-	-LPNN	\$4255.09	\$4524.86	\$4794.63	\$5064.40	\$5873.72	\$6683.04	\$7492.36	\$9111.01	\$6438.42	\$6743.05
	Left-Hand	SHLL-	-LPNL	4358.88	4628.65	4898.42	5168.19	5977.51	6786.83	7596.15	9214.80	6542.21	6846.84
	Right-Hand	SHLL-	-LPNR	4358.88	4628.65	4898.42	5168.19	5977.51	6786.83	7596.15	9214.80	6542.21	6846.84
Right-Hand	None	SHLL-	-LPRN	4358.88	4628.65	4898.42	5168.19	5977.51	6786.83	7596.15	9214.80	6542.21	6846.84
	Left-Hand	SHLL-	-LPRL	4462.67	4732.44	5002.21	5271.98	6081.30	6890.62	7699.94	9318.59	6646.00	6950.63
<b>Tablet - Painted MDF - Right-Hand</b>													
None	None	SHLL-	-RPNN	\$4255.09	\$4524.86	\$4794.63	\$5064.40	\$5873.72	\$6683.04	\$7492.36	\$9111.01	\$6438.42	\$6743.05
	Left-Hand	SHLL-	-RPNL	4358.88	4628.65	4898.42	5168.19	5977.51	6786.83	7596.15	9214.80	6542.21	6846.84
	Right-Hand	SHLL-	-RPNR	4358.88	4628.65	4898.42	5168.19	5977.51	6786.83	7596.15	9214.80	6542.21	6846.84
Left-Hand	None	SHLL-	-RPLN	4358.88	4628.65	4898.42	5168.19	5977.51	6786.83	7596.15	9214.80	6542.21	6846.84
	Right-Hand	SHLL-	-RPLR	4462.67	4732.44	5002.21	5271.98	6081.30	6890.62	7699.94	9318.59	6646.00	6950.63
<b>Tablet - HPL A - Left-Hand</b>													
None	None	SHLL-	-LLNN	\$4479.79	\$4749.56	\$5019.33	\$5289.10	\$6098.42	\$6907.74	\$7717.06	\$9335.71	\$6663.12	\$6967.75
	Left-Hand	SHLL-	-LLNL	4583.58	4853.35	5123.12	5392.89	6202.21	7011.53	7820.85	9439.50	6766.91	7071.54
	Right-Hand	SHLL-	-LLNR	4583.58	4853.35	5123.12	5392.89	6202.21	7011.53	7820.85	9439.50	6766.91	7071.54
Right-Hand	None	SHLL-	-LLRN	4583.58	4853.35	5123.12	5392.89	6202.21	7011.53	7820.85	9439.50	6766.91	7071.54
	Left-Hand	SHLL-	-LLRL	4687.37	4957.14	5226.91	5496.68	6306.00	7115.32	7924.64	9543.29	6870.70	7175.33
<b>Tablet - HPL B - Left-Hand</b>													
None	None	SHLL-	-LLNN	\$4511.89	\$4781.66	\$5051.43	\$5321.20	\$6130.52	\$6939.84	\$7749.16	\$9367.81	\$6695.22	\$6999.85
	Left-Hand	SHLL-	-LLNL	4615.68	4885.45	5155.22	5424.99	6234.31	7043.63	7852.95	9471.60	6799.01	7103.64
	Right-Hand	SHLL-	-LLNR	4615.68	4885.45	5155.22	5424.99	6234.31	7043.63	7852.95	9471.60	6799.01	7103.64
Right-Hand	None	SHLL-	-LLRN	4615.68	4885.45	5155.22	5424.99	6234.31	7043.63	7852.95	9471.60	6799.01	7103.64
	Left-Hand	SHLL-	-LLRL	4719.47	4989.24	5259.01	5528.78	6338.10	7147.42	7956.74	9575.39	6902.80	7207.43
<b>Tablet - HPL A - Right-Hand</b>													
None	None	SHLL-	-RLNN	\$4479.79	\$4749.56	\$5019.33	\$5289.10	\$6098.42	\$6907.74	\$7717.06	\$9335.71	\$6663.12	\$6967.75
	Left-Hand	SHLL-	-RLNL	4583.58	4853.35	5123.12	5392.89	6202.21	7011.53	7820.85	9439.50	6766.91	7071.54
	Right-Hand	SHLL-	-RLNR	4583.58	4853.35	5123.12	5392.89	6202.21	7011.53	7820.85	9439.50	6766.91	7071.54
Left-Hand	None	SHLL-	-RLLN	4583.58	4853.35	5123.12	5392.89	6202.21	7011.53	7820.85	9439.50	6766.91	7071.54
	Right-Hand	SHLL-	-RLLR	4687.37	4957.14	5226.91	5496.68	6306.00	7115.32	7924.64	9543.29	6870.70	7175.33
<b>Tablet - HPL B - Right-Hand</b>													
None	None	SHLL-	-RLNN	\$4511.89	\$4781.66	\$5051.43	\$5321.20	\$6130.52	\$6939.84	\$7749.16	\$9367.81	\$6695.22	\$6999.85
	Left-Hand	SHLL-	-RLNL	4615.68	4885.45	5155.22	5424.99	6234.31	7043.63	7852.95	9471.60	6799.01	7103.64
	Right-Hand	SHLL-	-RLNR	4615.68	4885.45	5155.22	5424.99	6234.31	7043.63	7852.95	9471.60	6799.01	7103.64
Left-Hand	None	SHLL-	-RLLN	4615.68	4885.45	5155.22	5424.99	6234.31	7043.63	7852.95	9471.60	6799.01	7103.64
	Right-Hand	SHLL-	-RLLR	4719.47	4989.24	5259.01	5528.78	6338.10	7147.42	7956.74	9575.39	6902.80	7207.43

# Hello Lounge Chair

Cup Holder	Bag Hook	Number		Fabric								Leather	
		①	②	A	B	C	D	E	F	G	H	A	B
<b>Tablet - Wood - White Oak - Left-Hand</b>													
None	None	SHLL-	-LWNN	\$ 5257.68	\$ 5527.45	\$ 5797.22	\$6066.99	\$ 6876.31	\$ 7685.63	\$8494.95	\$ 10113.60	\$ 7441.01	\$ 7745.64
	Left-Hand	SHLL-	-LWNL	5361.47	5631.24	5901.01	6170.78	6980.10	7789.42	8598.74	10217.39	7544.80	7849.43
	Right-Hand	SHLL-	-LWNR	5361.47	5631.24	5901.01	6170.78	6980.10	7789.42	8598.74	10217.39	7544.80	7849.43
Right-Hand	None	SHLL-	-LWRN	5361.47	5631.24	5901.01	6170.78	6980.10	7789.42	8598.74	10217.39	7544.80	7849.43
	Left-Hand	SHLL-	-LWRL	5465.26	5735.03	6004.80	6274.57	7083.89	7893.21	8702.53	10321.18	7648.59	7953.22
<b>Tablet - Wood - Walnut - Left-Hand</b>													
None	None	SHLL-	-LWNN	\$ 5321.88	\$ 5591.65	\$ 5861.42	\$ 6131.19	\$6940.51	\$ 7749.83	\$8559.15	\$ 10177.80	\$ 7505.21	\$ 7809.84
	Left-Hand	SHLL-	-LWNL	5425.67	5695.44	5965.21	6234.98	7044.30	7853.62	8662.94	10281.59	7609.00	7913.63
	Right-Hand	SHLL-	-LWNR	5425.67	5695.44	5965.21	6234.98	7044.30	7853.62	8662.94	10281.59	7609.00	7913.63
Right-Hand	None	SHLL-	-LWRN	5425.67	5695.44	5965.21	6234.98	7044.30	7853.62	8662.94	10281.59	7609.00	7913.63
	Left-Hand	SHLL-	-LWRL	5529.46	5799.23	6069.00	6338.77	7148.09	7957.41	8766.73	10385.38	7712.79	8017.42
<b>Tablet - Wood - White Oak - Right-Hand</b>													
None	None	SHLL-	-RWNN	\$ 5257.68	\$ 5527.45	\$ 5797.22	\$6066.99	\$ 6876.31	\$ 7685.63	\$8494.95	\$ 10113.60	\$ 7441.01	\$ 7745.64
	Left-Hand	SHLL-	-RWNL	5361.47	5631.24	5901.01	6170.78	6980.10	7789.42	8598.74	10217.39	7544.80	7849.43
	Right-Hand	SHLL-	-RWNR	5361.47	5631.24	5901.01	6170.78	6980.10	7789.42	8598.74	10217.39	7544.80	7849.43
Left-Hand	None	SHLL-	-RWLN	5361.47	5631.24	5901.01	6170.78	6980.10	7789.42	8598.74	10217.39	7544.80	7849.43
	Right-Hand	SHLL-	-RWLR	5465.26	5735.03	6004.80	6274.57	7083.89	7893.21	8702.53	10321.18	7648.59	7953.22
<b>Tablet - Wood - Walnut - Right-Hand</b>													
None	None	SHLL-	-RWNN	\$ 5321.88	\$ 5591.65	\$ 5861.42	\$ 6131.19	\$6940.51	\$ 7749.83	\$8559.15	\$ 10177.80	\$ 7505.21	\$ 7809.84
	Left-Hand	SHLL-	-RWNL	5425.67	5695.44	5965.21	6234.98	7044.30	7853.62	8662.94	10281.59	7609.00	7913.63
	Right-Hand	SHLL-	-RWNR	5425.67	5695.44	5965.21	6234.98	7044.30	7853.62	8662.94	10281.59	7609.00	7913.63
Left-Hand	None	SHLL-	-RWLN	5425.67	5695.44	5965.21	6234.98	7044.30	7853.62	8662.94	10281.59	7609.00	7913.63
	Right-Hand	SHLL-	-RWLR	5529.46	5799.23	6069.00	6338.77	7148.09	7957.41	8766.73	10385.38	7712.79	8017.42

The following option requires modification of the product number.

Stain repellent To specify, add **P** to the end of the product number (add **\$150.00** list); **Example:** SHLL-22-NNRL1P

# Hello Pouf

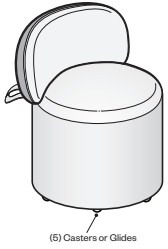

(5) Casters or Glides

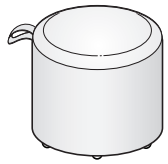

SHLP  
Class QAO

### Features

- Includes one pouf seat with pull strap and optional bolster.
- Casters and glides available in black only.
- Pull strap available in black only.
- Bolster is not field retrofittable.
- COM Yardage / COL square footage:  
 Seat: 0.75 / 3.65  
 Bottom: 1.8 / 4.2  
 Seat/Inner Bolster: 1.0 / 5.85  
 Bottom/Outer Bolster: 2.0 / 5.25

### Dimensions

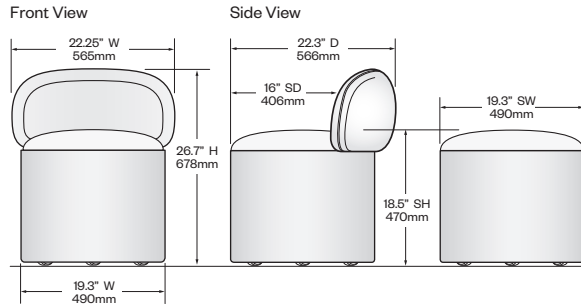

### To Order, Specify:

1) Product number, including:

**1 Seat/Inner Bolster Upholstery:**

- 1 Leather
- 2 Fabric
- 3 Faux Leather

**2 Bottom/Outer Bolster Upholstery:**

- 1 Leather
- 2 Fabric
- 3 Faux Leather

**3 Caster/Glide Option:**

- 1 Hard Casters
- 2 Soft Casters
- H Plastic Glides
- K Felt Glides

2) Seat/Inner Bolster upholstery.

3) Bottom/Outer Bolster upholstery.

Description	Number			Fabric							Leather		
	1	2	3	A	B	C	D	E	F	G	H	A	B
No bolster	SHLP-	-N		\$1357.63	\$1474.94	\$1592.26	\$1709.57	\$2061.51	\$2413.46	\$2765.40	\$3469.28	\$2097.78	\$2160.61
With bolster	SHLP-	-B		1922.26	2039.57	2156.89	2274.20	2626.14	2978.09	3330.03	4033.91	2662.41	2725.24

The following option requires modification of the product number.

Stain repellent

To specify, add **P** to the end of the product number (add **\$50.00** list); **Example:** SHLP-22-NIP

# ToDo

## Upholstered Chair

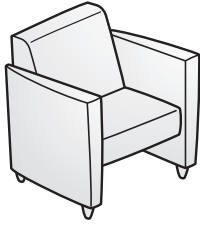

TQ84-0011

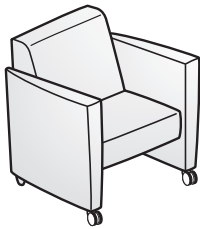

TQ85-0011  
Class QA

### Features

- Fully upholstered chair stationary with feet or mobile on casters.
- Chair may be upholstered in matching materials or may have seat and back in one material/color and a different material/color for the arms.
- COM yardage / COL square footage: 5.0/96.0
  - Seat and Back: 4.0/72.0
  - Arms Only: 3.0/54.0

### Specification Tips

- When specifying mixed grade materials please refer to design and specification tools.
- Designed for use by individuals up to 325 lbs.

### Dimensions

Height:	Depth:	Width:
H: 31.25"(794mm)	D: 29.25"(743mm)	W: 30"(762mm)
SH: 17.5"(445mm)	SD: 19"(483mm)	SW: 21.5"(546mm)
AH: 24.125"(613mm)		

### To Order, Specify:

- Product number.
- Fabric or
  - Fabric for seat and back.
  - Fabric for arms.
- Trim color for feet and handle.

Description	Fabric								Leather		
	A	B	C	D	E	F	G	H	A	B	
<b>Stationary</b>											
<b>One Fabric</b>											
Standard	TQ84-0011	\$4395.65	\$4537.31	\$4767.75	\$4922.71	\$5463.03	\$6193.77	\$6574.61	\$7642.01	\$6866.97	\$8234.03
With Handle	TQ84-0011-H	4535.17	4676.83	4907.27	5062.23	5602.55	6333.29	6714.13	7781.53	7006.49	8373.55
<b>Two Fabrics</b>											
Standard	TQ84-T011	\$4546.25	\$4687.91	\$4918.35	\$5073.31	\$5613.63	\$6344.37	\$6725.21	\$7792.61	\$7017.57	\$8384.63
With Handle	TQ84-T011-H	4685.77	4827.43	5057.87	5212.83	5753.15	6483.89	6864.73	7932.13	7157.09	8524.15
<b>Mobile</b>											
<b>One Fabric</b>											
Standard	TQ85-0011	\$4395.65	\$4537.31	\$4774.33	\$4931.57	\$5463.03	\$6193.77	\$6583.53	\$7648.71	\$6869.23	\$8229.81
With Handle	TQ85-0011-H	4535.17	4676.83	4913.85	5071.09	5602.55	6333.29	6723.05	7788.23	7008.75	8369.33
<b>Two Fabrics</b>											
Standard	TQ85-T011	\$4546.25	\$4687.91	\$4924.93	\$5082.17	\$5613.63	\$6344.37	\$6734.13	\$7799.31	\$7019.83	\$8380.41
With Handle	TQ85-T011-H	4685.77	4827.43	5064.45	5221.69	5753.15	6483.89	6873.65	7938.83	7159.35	8519.93

The following options require modification of the product number.

Faux Leather	To specify, change the 3rd digit from an 8 to a <b>3</b> ; <b>Example:</b> TQ34-0011
Leather	To specify, change the 3rd digit from an 8 to a <b>7</b> ; <b>Example:</b> TQ74-0011
Stain repellent	To specify, add <b>-P</b> to the end of the product number (add <b>\$115.12</b> list); <b>Example:</b> TQ84-0011- <b>P</b>
Moisture Barrier with Stain Repellent	To specify, add <b>-D</b> to the end of the product number (add <b>\$181.57</b> list); <b>Example:</b> TQ84-0011- <b>D</b>

For available fabrics, refer to [surfaces.haworth.com](http://surfaces.haworth.com).

# Tilt Stool

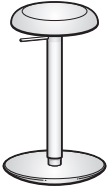

STS-1  
Class VY – Open Market

### Features

- Base: Overmolded structural urethane covered with steel.
- Base is rounded to allow movement and allow user to lean on stool.
- Seat: Urethane with an MDF substrate.
- Seat available in black only.
- Steel column with pneumatic height adjustment.
- Available in four trim colors. Black (TR-F), Graphite (TR-J), Accent Orange (TR-1E) or Smooth Plaster (TR-PLS).

### Specification Tips

- Plant feet firmly on the floor while leaning on the seat.
- Rounded base allows movement in any direction.

### Dimensions

Height:	Diameter
SH: 23.5-34.75" (597-883mm)	Seat: 12"(305mm) Base: 14"(356mm) Col: 2"(51mm)

### To Order, Specify:

- 1) Product number.
- 2) Trim color.

Number	Price
STS-1	\$2494.69

# Haworth Seating Resources

Surfaces Materials

Index

Warranty

# Surface Materials

## Finish Color Legend

### Breck

**Plastic Trim**

- TR-F Black
- TR-UFM Snow

**Plastic Base**

- TR-F Black
- TR-UFM Snow

**Aluminum Base**

- PM-P Polished Aluminum
- TR-TF Pitch
- TR-UFS Snowfall

**GeoStretch Back**

- TR-2B Agave
- TR-F Black
- TR-2C Lagoon
- TR-2A Lunar
- TR-2E Rosewater
- TR-2D Stone

### Candor

**Wood**

- M3-CA1 Amber
- M3-W23 American
- M3-W33 Caramel
- M3-RE Ebony
- M3-W15 Espresso
- M3-W30 Heritage
- M3-W04 Natural
- M3-W32 Pacific
- M3-W31 Retro

### Cardigan

**Trim**

- TR-SW Aluminum Graphite
- TR-LE0 Silver
- TR-40 Textured Black
- TR-1G0 Textured Blue Jay
- TR-CT0 Textured Chartreuse
- TR-1Q0 Textured Park
- TR-RR0 Textured Rusty Red
- TR-1M0 Textured Sable
- TR-P80 Textured Sand
- TR-1J0 Textured Sky Blue
- TR-1H0 Textured Terra
- TR-TW0 Textured White
- TR-1K0 Textured Wren

**Knit**

- HAL-CB01 Dark Green
- HAL-CB04 Grey
- HAL-CB03 Light Blue
- HAL-CB02 Light Green
- HAL-CB05 Red
- HAL-CB06 Yellow

**Pillow Knit**

- HAL-CW01 Dark Green
- HAL-CW04 Grey
- HAL-CW03 Light Blue
- HAL-CW02 Light Green
- HAL-CW05 Red
- HAL-CW06 Yellow

### Composites

**Wood**

- M2-CA1\* Amber
- M2-W23 American
- M2-W33 Caramel
- M2-W15\* Espresso
- M2-W30 Heritage
- M2-N Natural
- M2-W32 Pacific
- M2-W31\* Retro

### Fern

**Plastic Trim**

- TR-F Black
- TR-7 Fog
- TR-UFM Snow

**Aluminum Trim**

- TR-BG Light Bronze
- TR-MC Metallic Champagne
- TR-LE Metallic Silver
- TR-TF Pitch
- TR-UFS Snowfall
- PM-P Polished Aluminum

**Plastic Base**

- TR-F Black
- TR-7 Fog

**Aluminum Base**

- TR-BG Light Bronze
- TR-MC Metallic Champagne
- TR-LE Metallic Silver
- TR-TF Pitch
- TR-UFS Snowfall
- PM-P Polished Aluminum

**Knit**

- XQ2-CB Charcoal Black
- XQ2-DR Dune Rose
- XQ2-EM Emberglow
- XQ2-HG Heather Grey
- XQ2-LG Lagoon
- XQ2-MG Mist Grey
- XQ2-MR Mariner
- XQ2-WT Waterside

**Gradient Knit**

- XA-1 Beach Glass
- XA-2 Grey Basalt
- XA-3 Northern Lights
- XA-4 Sea Pearl
- XA-5 Woodland Frost

**Mesh**

- MB-BE Beach
- MB-CL Coal
- MB-CF Cornflower
- MB-MF Moon Flower
- MB-MU Mulch
- MB-MR Mushroom
- MB-PM Peat Moss
- MB-RR River Rock
- MB-SE Sedum
- MB-SL Silver Leaf

### Hello

**Trim**

- TR-F Black
- TR-UPLS Smooth Plaster

### Improv

**Trim**

- TR-F Black
- TR-J Graphite
- TR-G Gray Tone
- TR-E Smoke

**Metallic Trim**

- TR-MC Champagne
- TR-LE Silver

**Wood**

- M2-CA1 Amber
- M2-W23 American
- M2-W33 Caramel
- M2-W15 Espresso
- M2-W30 Heritage
- M2-W32 Pacific
- M2-W31 Retro

### Maari

**Shell/Arm Caps**

**Polymer**

- TR-IT Balsam
- TR-F Black
- TR-CF Coffee
- TR-G Gray Tone
- TR-IV Indigo
- TR-RR Rusty Red
- TR-PLS Smooth Plaster
- TR-IW Water

**Sled Base**

**Trim**

- TR-F Black
- TR-LE Metallic Silver
- TR-RR Rusty Red
- TR-PLS Smooth Plaster
- KR-V Chrome

**Matte Trim**

- TR-M1 Black Matte
- TR-M2 Smooth Plaster Matte

**Four-Leg**

**Trim**

- TR-F Black
- TR-LE Metallic Silver
- TR-RR Rusty Red
- TR-PLS Smooth Plaster

**Matte Trim**

- TR-M1 Black Matte
- TR-M2 Smooth Plaster Matte

**Wood-Leg**

**Wood**

- M5-W35 Clear on White Oak
- M5-W43 Ink on Oak
- M5-W44 Walnut on Oak

**Four-Star and Five-Star Base**

**Trim**

- TR-F Black
- TR-PLS Smooth Plaster

**Matte Trim**

- TR-M1 Black Matte
- TR-M2 Smooth Plaster Matte

**Tablet**

**Wood**

- VH-W35 Plank Walnut
- VB-W35 Plank White Oak

**Painted MDF**

- PW-F Black
- PW-PL Polar

**HPL**

- H-8J Charcoal
- H-KM Landmark
- H-WL Linen
- H-KL Neo Walnut

# Surface Materials

## Finish Color Legend

### Openest

**Trim**

TR-F	Black
TR-PLS	Smooth Plaster
TR-RR	Rusty Red

**Thread**

NS-1E	Accent Orange
NS-F	Black
NS-PLS	Plaster
NS-RR	Rusty Red
NS-SN	Sand

**Table Surfaces - Painted**

PW-F	Black
PW-PL	Polar

**Spring Table Surfaces - Wood**

VB-W35	Plank White Oak
VH-W35	Plank Walnut

### Poppy

#### Guest

**Trim**

TR-F	Black
TR-PLS	Smooth Plaster

#### Lounge

**Trim**

TR-F	Black
TR-1M	Sable
TR-RR	Rusty Red
TR-PLS	Smooth Plaster

#### Wood

M5-W35	Clear on Oak
M6-W35	Clear on Walnut
M7-W43	Ink on Ash

#### Tablet

#### Wood

VH-W35	Plank Walnut
VB-W35	Plank White Oak

#### Painted MDF

PW-F	Black
PW-PL	Polar

#### HPL

H-8J	Charcoal
H-KM	Landmark
H-WL	Linen
H-KL	Neo Walnut

### Resonate

#### Trim

TR-1G	Blue Jay
TR-K	Charcoal
TR-RR	Rusty Red
TR-PLS	Smooth Plaster

#### HPL

#### Grade A

#### Solid

H-WL	Linen
H-AA	Putty
H-8J	Charcoal

#### Grade B

#### Wood Grain

H-KP	Field Elm
H-KM	Landmark
H-KL	Neo Walnut

#### Edgeband

HP-PW	Natural Ply Edge
-------	------------------

### Riverbend

**Trim**

TR-AR	Argent
TR-F	Black
TR-TF	Pitch (textured)
TR-TW	Plaster (textured)

### Soji

#### Plastic Trim

TR-F	Black
TR-7	Fog
TR-UFM	Snow

#### Plastic Base

TR-F	Black
TR-7	Fog

#### Aluminum Base

TR-F	Black
TR-LE	Metallic Silver
PM-P	Polished Aluminum

#### Knit

XT-1	Carbon
XT-2	Cayenne
XT-3	Clay
XT-4	Juniper
XT-5	Mist
XT-6	Navy
XT-7	Ocean
XT-9	Steel
XT-10	Stone

### ToDo

#### Trim

TR-F	Black
TR-LE	Metallic Silver

### Very Side

#### Polymer

TR-F	Black
TR-FL	Canvas
TR-FK	Cocoa
TR-CF	Coffee (Perf. Back and Wire Stacker only)

TR-7	Fog
TR-HR	Heron (Perf. Back and Wire Stacker only)
TR-KL	Kale (Perf. Back and Wire Stacker only)

TR-FJ	Slate
TR-FM	Snow
TR-FA	Tomato

#### Trim

TR-F	Black
TR-7	Fog

#### Base - Painted

TR-F	Black
TR-MC	Metallic Champagne
TR-LE	Metallic Silver
PM-P	Polished Aluminum (conference chair only)
KR-V	Trivalent Chrome (wire stacker, side and seminar)

#### Base - Plastic

#### (conference chair only)

TR-F	Black
TR-7	Fog

### Very Task

#### Plastic Trim

TR-F	Black
TR-7	Fog
TR-UFM	Snow

#### Aluminum Upright

TR-F	Black
TR-MC	Metallic Champagne
TR-LE	Metallic Silver
TR-FS	Snowfall
PM-P	Polished Aluminum

#### Plastic Base

TR-F	Black
TR-7	Fog

#### Aluminum Base

PM-P	Polished Aluminum
TR-F	Black
TR-MC	Metallic Champagne
TR-LE	Metallic Silver

#### Knit

XY-1	Cinnamon
XY-2	Jasper
XY-3	Jute
XY-4	Sea Glass
XY-5	Shale

#### Mesh

MS-F	Black
MS-FK	Cocoa
MS-7	Fog
MS-HR	Heron
MS-KL	Kale
MS-FJ	Slate
MS-FM	Snow

### Wyn

#### Trim

TR-F	Black
TR-UPLS	Smooth Plaster

#### Painted MDF

PW-F	Black
PW-PL	Polar

#### HPL

H-8J	Charcoal
H-KM	Landmark
H-WL	Linen
H-KL	Neo Walnut

#### Wood

VB-W35	Plank White Oak
VH-W35	Plank Walnut

### X99

#### Trim

TR-F	Black
KR-V	Chrome

#### Metallic Trim

TR-LE	Silver
-------	--------

#### Mesh

MO-BL	Black
-------	-------

### Zody Task

#### Plastic Trim

TR-F	Black
TR-E	Smoke
TR-UFM	Snow

#### Aluminum Trim

TR-F	Black
TR-LE	Metallic Silver
TR-MC	Metallic Champagne
PM-P	Polished Aluminum

#### Plastic Base

TR-F	Black
------	-------

#### Aluminum Base

TR-F	Black
TR-LE	Metallic Silver
TR-MC	Metallic Champagne
PM-P	Polished Aluminum

#### Knit

X4-2	Emerald
X4-3	Moonstone
X4-1	Onyx
X4-4	Rosewood
X4-5	Topaz

#### Mesh

MA-2	Comfort
MA-4	Relax
MA-1	Support
MA-3	Wellness

### Zody Guest

#### Arm Caps

TR-F	Black
TR-E	Smoke

#### Base/Frame

TR-F	Black
TR-LE	Metallic Silver
TR-MC	Metallic Champagne
TR-MG	Metallic Gunmetal
KR-V	Trivalent Chrome

#### Wood Back

VT-W04	Beech
--------	-------

# Surface Materials

## Finish Color Legend

### Zody II and Zody LX

**Plastic Trim**

TR-F	Black
TR-7	Fog
TR-UFM	Snow

**Aluminum Trim**

TR-BG	Light Bronze
TR-MC	Metallic Champagne
TR-LE	Metallic Silver
TR-TF	Pitch
TR-UFS	Snowfall
PM-P	Polished Aluminum

**Plastic Base**

TR-F	Black
TR-7	Fog

**Aluminum Base**

TR-BG	Light Bronze
TR-MC	Metallic Champagne
TR-LE	Metallic Silver
TR-TF	Pitch
TR-UFS	Snowfall
PM-P	Polished Aluminum

**Zody II Knit**

X4-2	Emerald
X4-3	Moonstone
X4-1	Onyx
X4-4	Rosewood
X4-5	Topaz

**Zody II Mesh**

MA2-4	Balsam
MA2-5	Bark
MA2-2	Comfort
MA2-6	Engine
MA2-7	Fog
MA2-8	Navy
MA2-1	Support
MA2-9	Water
MA2-3	Wellness

**ALERT:** These materials are current, however they are being considered for future obsolescence due to low volume.

**Wood**

Maple

M2-W07	Light Anegre
M2-W08	Golden Anegre
M2-N	Natural
M2-W12	Naturally Walnut

Beech

M3-W07	Light Anegre
M3-W08	Golden Anegre
M3-W12	Natural Walnut
M3-RW	Wenge

**Trim**

TR-1E	Accent Orange
TR-1F	Accent Red
TR-CTS	Chartreuse
TR-1H	Terra
TR-1K	Wren

Because of the natural properties of wood, variations of grain pattern and finish color can be expected. Haworth carefully selects materials used in the manufacturing of products to promote consistent and acceptable color. Wood is susceptible to color change from exposure to UV rays. Haworth finishes include a UV stabilizer to reduce these effects.

Natural finish on Maple is a clear coat only and will show all the characteristics of the wood.

Compatible wood finish color will complement wood casegoods finish color, not necessarily wood species characteristics.

**Note:**

- Specifying a common stain color for casegoods, wood seating, and wood occasional tables will result in a suite of furniture which has a commercially acceptable finish match.
- Different wood species are offered on the various casegoods, chairs, and tables. Each species offer unique texture, grain, and color of raw wood and veneer. Minor variations in finish color and texture may occur due to these natural characteristics of wood. This is part of the natural beauty of wood and is not considered to be a defect.

**Forest Stewardship Council® (FSC®) Statement:**

In our continuing support of sustainable forestry and responsible purchasing, Haworth North America is offering FSC certified wood products at no up-charge. By providing FSC certified material, Haworth is supporting our client's green building goals and demonstrating our collective commitment to source materials more sustainably. Haworth will provide to you the necessary FSC certified paperwork with your shipment. For more information, FAQs, and a complete FSC product list (including product exceptions), go to the Library and search FSC. Haworth FSC Trademark License #FSC-C002821

# Surface Materials

## Fabrics/Color Legend

Grade: Pattern (Surface Code)	Series/ Model																			
	Breck	Candor	Composites	Fern	Hello	Improv	Maari	Openest	Openest Pillows	Pebble	Poppy	Resonate	Riverbend	Soji	ToDo	Very/Very Task	Wyn	X99	Zody	Zody II, Zody LX
<b>Haworth Fabrics</b>																				
A: Blanket (4H)	●	●	●	●	●	●	●	●	●	●	●	●	●	●	●	●	●	●	●	●
A: Hobson (3J)	●	●	●	●	●	●	●	●	●	●	●	●	●	●	●	●	●	●	●	●
A: Morse (4J)	●	●	●	●	●	●	●	●	●	●	●	●	●	●	●	●	●	●	●	●
A: Novelty (3L)	●	●	●	●	●	●	●	●	●	●	●	●	●	●	●	●	●	●	●	●
A: Pixel (2A)	●	●	●	●	●	●	●	●	●	●	●	●	●	●	●	●	●	●	●	●
A: Tellure (3A)	●	●	●	●	●	●	●	●	●	●	●	●	●	●	●	●	●	●	●	●
A: Twist (MM)	●	●	●	●	●	●	●	●	●	●	●	●	●	●	●	●	●	●	●	●
A: Wellington Faux Leather (XJ)	●	●	●	●	●	●	●	●	●	●	●	●	●	●	●	●	●	●	●	●
B: Diagonale (4N)	●	●	●	●	●	●	●	●	●	●	●	●	●	●	●	●	●	●	●	●
B: Element (4Z)	●	●	●	●	●	●	●	●	●	●	●	●	●	●	●	●	●	●	●	●
B: English Tweed (4E)	●	●	●	●	●	●	●	●	●	●	●	●	●	●	●	●	●	●	●	●
B: Floyd by Kvadrat (S6)	●	●	●	●	●	●	●	●	●	●	●	●	●	●	●	●	●	●	●	●
B: Gauge (1X)	●	●	●	●	●	●	●	●	●	●	●	●	●	●	●	●	●	●	●	●
B: Kaleidoscope (S4)	●	●	●	●	●	●	●	●	●	●	●	●	●	●	●	●	●	●	●	●
B: Pemberton (SN)	●	●	●	●	●	●	●	●	●	●	●	●	●	●	●	●	●	●	●	●
B: Ramie (4V)	●	●	●	●	●	●	●	●	●	●	●	●	●	●	●	●	●	●	●	●
B: Reflect by Kvadrat (S8)	●	●	●	●	●	●	●	●	●	●	●	●	●	●	●	●	●	●	●	●
B: Tech (MV)	●	●	●	●	●	●	●	●	●	●	●	●	●	●	●	●	●	●	●	●
C: Dots (6K)	●	●	●	●	●	●	●	●	●	●	●	●	●	●	●	●	●	●	●	●
C: King II (67)	●	●	●	●	●	●	●	●	●	●	●	●	●	●	●	●	●	●	●	●
C: Maya II (68)	●	●	●	●	●	●	●	●	●	●	●	●	●	●	●	●	●	●	●	●
C: Oceanic (4T)	●	●	●	●	●	●	●	●	●	●	●	●	●	●	●	●	●	●	●	●
C: Scapes (3S)	●	●	●	●	●	●	●	●	●	●	●	●	●	●	●	●	●	●	●	●
D: Atlas by Kvadrat (LW)	●	●	●	●	●	●	●	●	●	●	●	●	●	●	●	●	●	●	●	●
D: Big Arrow (4D)	●	●	●	●	●	●	●	●	●	●	●	●	●	●	●	●	●	●	●	●
D: Big Diagonale (1K)	●	●	●	●	●	●	●	●	●	●	●	●	●	●	●	●	●	●	●	●
D: Clara 2 by Kvadrat (NV)	●	●	●	●	●	●	●	●	●	●	●	●	●	●	●	●	●	●	●	●
D: Class II (66)	●	●	●	●	●	●	●	●	●	●	●	●	●	●	●	●	●	●	●	●
D: Cotswold (JB)	●	●	●	●	●	●	●	●	●	●	●	●	●	●	●	●	●	●	●	●
D: Main Line Flax (6M)	●	●	●	●	●	●	●	●	●	●	●	●	●	●	●	●	●	●	●	●
D: Melange Nap by Kvadrat (S7)	●	●	●	●	●	●	●	●	●	●	●	●	●	●	●	●	●	●	●	●
D: Recheck by Kvadrat (RP)	●	●	●	●	●	●	●	●	●	●	●	●	●	●	●	●	●	●	●	●
E: Brisa Faux Leather (XG)	●	●	●	●	●	●	●	●	●	●	●	●	●	●	●	●	●	●	●	●
E: Steelcut Trio by Kvadrat (SY)	●	●	●	●	●	●	●	●	●	●	●	●	●	●	●	●	●	●	●	●
F: Divina Melange 3 by Kvadrat (SV)	●	●	●	●	●	●	●	●	●	●	●	●	●	●	●	●	●	●	●	●
F: Hallingdal 65 by Kvadrat (SZ)	●	●	●	●	●	●	●	●	●	●	●	●	●	●	●	●	●	●	●	●
<b>Leathers</b>																				
A: Plains Leather (XP)	●	●	●	●	●	●	●	●	●	●	●	●	●	●	●	●	●	●	●	●
B: Nature Leather (XE)	●	●	●	●	●	●	●	●	●	●	●	●	●	●	●	●	●	●	●	●

\*For most current finish and fabric availability please reference [surfaces.haworth.com](https://surfaces.haworth.com).

**ALERT:** These materials are current, however they are being considered for future obsolescence due to low volume.

**Fabric**

Grade A  
MM      Twist

Grade B  
1X      Gauge

# Index

Products are listed alphabetically in this index by alpha-numeric prefix/suffix codes.

<b>Product Code</b>	<b>Product Description</b>	<b>Page</b>
4045-00	Composites – Guest/Occasional Seating — Arc Arm, Upholstered Back	.138
4049-00	Composites – Guest/Occasional Seating — Stool, Armless, Upholstered Back	.138
CDSL-UU	Cardigan Lounge – Chair	.182
CDSL-UU	Cardigan Lounge – Pillow	.182
EUSM-HFOW-1100	Riverbend Power Module – Hardwire	.165
EUSM-HFOW-2100	Riverbend Power Module – Hardwire	.165
EUSM-HLOW-1100	Riverbend Power Module – Hardwire	.165
EUSM-HLOW-2100	Riverbend Power Module – Hardwire	.165
EUSM-PFOW-2100	Riverbend Power Module – Corded	.165
EUSM-PLow-2100	Riverbend Power Module – Corded	.165
M600-2110	Improv – Leg-Base Stacking Chairs	.115
M600-2310	Improv – Leg-Base Stacking Chairs	.115
M600-8100	Improv – Stools	.117
M600-8110	Improv – Stools	.117
M601-2110	Improv – Sled-Base Chairs — Non-Stacking	.116
M601-2300	Improv – Sled-Base Chairs — Non-Stacking	.116
MPRV-BARS	Improv – Accessories — Chair-to-Chair	.118
MPRV-CART	Improv – Accessories — Stacking Dolly	.118
S2TC-20-0	Zody II – Task Chair	.31
S2TC-20-1	Zody II – Task Chair	.31
S2TC-20-4	Zody II – Task Chair	.31
S2TC-20-7	Zody II – Task Chair	.31
S2TD-20-1	Zody II – Dual Posture	.36
S2TD-20-4	Zody II – Dual Posture	.36
S2TD-20-7	Zody II – Dual Posture	.36
S2TS-20-0	Zody II – Task Stool	.34
S2TS-20-1	Zody II – Task Stool	.34
S2TS-20-4	Zody II – Task Stool	.34
S2TS-20-7	Zody II – Task Stool	.34
S2UC-22-0	Zody LX – Task Chair	.44
S2UC-22-1	Zody LX – Task Chair	.44
S2UC-22-4	Zody LX – Task Chair	.44
S2UC-22-7	Zody LX – Task Chair	.44
S2UD-22-1	Zody LX – Dual Posture	.48
S2UD-22-4	Zody LX – Dual Posture	.48
S2UD-22-7	Zody LX – Dual Posture	.48
S2US-22-0	Zody LX – Task Stool	.46
S2US-22-1	Zody LX – Task Stool	.46
S2US-22-4	Zody LX – Task Stool	.46
S2US-22-7	Zody LX – Task Stool	.46
S74-22-1H	Maari – Four-Star Base Chair	.129
S74-24-1H	Maari – Four-Star Base Chair	.129
S74-44-0H	Maari – Four-Star Base Chair	.129
S75-22-11	Maari – Five-Star Base Chair	.130
S75-24-11	Maari – Five-Star Base Chair	.130
S75-44-01	Maari – Five-Star Base Chair	.130
S7H-22-1H	Maari – Sled Base Chair	.126
S7H-24-1H	Maari – Sled Base Chair	.126
S7H-44-0H	Maari – Sled Base Chair	.126
S7HB-22-0H	Maari – Sled Base Stool — Standard Back	.132
S7HB-24-0H	Maari – Sled Base Stool — Standard Back	.132

# Index

<b>Product Code</b>	<b>Product Description</b>	<b>Page</b>
S7HB-44-0H	Maari – Sled Base Stool — Standard Back	.132
S7HC-22-0H	Maari – Sled Base Stool — Standard Back	.132
S7HC-24-0H	Maari – Sled Base Stool — Standard Back	.132
S7HC-44-0H	Maari – Sled Base Stool — Standard Back	.132
S7S-22-1I	Maari – Four-Leg Chair	.127
S7S-24-1I	Maari – Four-Leg Chair	.127
S7S-44-0H	Maari – Four-Leg Chair	.127
S7SB-22-1H	Maari – Four-Leg Stool	.134
S7SB-24-1H	Maari – Four-Leg Stool	.134
S7SB-44-0H	Maari – Four-Leg Stool	.134
S7SC-22-1H	Maari – Four-Leg Stool	.134
S7SC-24-1H	Maari – Four-Leg Stool	.134
S7SC-44-0H	Maari – Four-Leg Stool	.134
S7W-22-0H	Maari – Wood-Leg Chair	.128
S7W-24-0H	Maari – Wood-Leg Chair	.128
S7W-44-0H	Maari – Wood-Leg Chair	.128
S7WB-22-0H	Maari – Wood-Leg Stool — Standard Back	.135
S7WB-24-0H	Maari – Wood-Leg Stool — Standard Back	.135
S7WB-44-0H	Maari – Wood-Leg Stool — Standard Back	.135
S7WC-22-0H	Maari – Wood-Leg Stool — Standard Back	.135
S7WC-24-0H	Maari – Wood-Leg Stool — Standard Back	.135
S7WC-44-0H	Maari – Wood-Leg Stool — Standard Back	.135
S8HB-24-0H	Maari – Sled Base Stool — Low Back	.133
S8HC-24-0H	Maari – Sled Base Stool — Low Back	.133
S8WB-24-0H	Maari – Wood-Leg Stool — Low Back	.136
S8WC-24-0H	Maari – Wood-Leg Stool — Low Back	.136
SAS-22-A1A	Candor – Guest/Occasional Seating — Fully Upholstered Seat and Back	.137
SAS-22-A3A	Candor – Guest/Occasional Seating — Fully Upholstered Seat and 1/2 Back	.137
SBSS	Breck – Stool	.107
SBTS	Breck – Task Chair	.106
SCB-44-0H	Very Perforated Side, Seminar and Side Stool – Seminar with Storage Rack — Perforated Back	.83
SCB-44-3H	Very Perforated Side, Seminar and Side Stool – Seminar with Storage Rack — Perforated Back	.83
SCC-44-0I	Very Perforated Conference Chair and Conference Stool – Conference Chair — Perforated Back	.85
SCC-44-1I	Very Perforated Conference Chair and Conference Stool – Conference Chair — Perforated Back	.85
SCF-44-0I	Very – Conference Stool — Perforated Back	.87
SCF-44-1I	Very – Conference Stool — Perforated Back	.87
SCH-44-3S	Very Wire Stacker – Wire Stacker	.73
SCH-44-0S	Very Wire Stacker – Wire Stacker	.73
SCK-44-3H	Very Perforated Side, Seminar and Side Stool – Side Chair with Storage Rack — Perforated Back	.79
SCL-44-0H	Very Perforated Side, Seminar and Side Stool – Bar Height Side Stool — Perforated Back	.80
SCL-44-3H	Very Perforated Side, Seminar and Side Stool – Bar Height Side Stool — Perforated Back	.80
SCLC-44-0H	Very Perforated Side, Seminar and Side Stool – Counter Height Side Stool — Perforated Back	.81
SCLC-44-3H	Very Perforated Side, Seminar and Side Stool – Counter Height Side Stool — Perforated Back	.81
SCM-44-0H	Very Perforated Side, Seminar and Side Stool – Seminar Chair — Perforated Back	.82
SCM-44-3H	Very Perforated Side, Seminar and Side Stool – Seminar Chair — Perforated Back	.82
SCS-44-0H	Very Perforated Side, Seminar and Side Stool – Side Chair — Perforated Back	.77
SCS-44-3H	Very Perforated Side, Seminar and Side Stool – Side Chair — Perforated Back	.77
SCS-44-RH	Very Perforated Side, Seminar and Side Stool – Side Chair with Tablet Arm — Perforated Back	.78
SCSG-1	Very – Accessories — Ganging Connector	.88
SCSG-2	Very – Accessories — Ganging Connector	.88
SCT-1	Very – Accessories — Stacking Carts	.88
SCT-20-001I	Very Task – Task Chair	.68

# Index

<b>Product Code</b>	<b>Product Description</b>	<b>Page</b>
SCT-20-1011	Very Task – Task Chair	.68
SCT-20-4011	Very Task – Task Chair	.68
SCT-20-7011	Very Task – Task Chair	.68
SCT-3	Very – Accessories — Stacking Carts	.88
SCT-4	Very – Accessories — Stacking Carts	.88
SCTC-20-0011	Very Task – Task Stool	.70
SCTC-20-1011	Very Task – Task Stool	.70
SCTC-20-4011	Very Task – Task Stool	.70
SCTC-20-7011	Very Task – Task Stool	.70
SCW-44-3S	Very Wire Stacker – Bar Height Wire Stool	.74
SCW-44-OS	Very Wire Stacker – Bar Height Wire Stool	.74
SCWC-44-OS	Very Wire Stacker – Counter Height Wire Stool	.75
SCWC-44-3S	Very Wire Stacker – Counter Height Wire Stool	.75
SE3S	Veda – Mid-Back Chair — Synchronized Tilt	.110
SE3T	Veda – Mid-Back Chair — Standard Tilt	.110
SE5S	Veda – High-Back Chair — Synchronized Tilt	.111
SFS-U0-0N01A	Fern – Task Stool	.22
SFS-U0-1S01A	Fern – Task Stool	.22
SFS-U0-4S01S	Fern – Task Stool	.22
SFS-U0-7S01A	Fern – Task Stool	.22
SFT-U0-0N01A	Fern – Task Chair	.20
SFT-U0-1S01A	Fern – Task Chair	.20
SFT-U0-4S01A	Fern – Task Chair	.20
SFT-U0-7S01A	Fern – Task Chair	.20
SHLL	Hello – Lounge Chair	.184
SHLP	Hello – Pouf	.187
SJT-20-011A	Soji – Task Chair	.95
SJT-20-111A	Soji – Task Chair	.95
SJT-20-401X	Soji – Task Chair	.95
SJT-20-711A	Soji – Task Chair	.95
SJTC-001A	Soji – Task Stool	.99
SJTC-001X	Soji – Task Stool	.99
SJTC-101A	Soji – Task Stool	.99
SJTC-101X	Soji – Task Stool	.99
SJTC-401A	Soji – Task Stool	.99
SJTC-401X	Soji – Task Stool	.99
SJTC-701A	Soji – Task Stool	.99
SJTC-701X	Soji – Task Stool	.99
SJTX-101A	Soji XL – Soji XL — Task Chair	.97
SLP-22-R	Poppy – Lounge — Swivel	.176
SLP-22-S	Poppy – Lounge — Swivel	.176
SLP-22-T	Poppy – Lounge — Basket	.176
SMCH-2256-HS	Riverbend – Curved — Concave — 90° Concave	.159
SMCH-2258-HS	Riverbend – Curved — Concave — 60° Concave	.160
SMCM-2256-HS	Riverbend – Curved — Concave — 90° Concave	.159
SMCM-2258-HS	Riverbend – Curved — Concave — 60° Concave	.160
SMCN-2056-HS	Riverbend – Curved — Concave — 90° Concave	.159
SMCN-2058-HS	Riverbend – Curved — Concave — 60° Concave	.160
SMG-1	Riverbend Accessories – Ganging Bracket	.164
SMQM-2240-H	Riverbend – Corner — Square	.162
SMQN-2040-H	Riverbend – Corner — Square	.162
SMSH-2255-H	Riverbend – Straight — Double Seat	.157

# Index

<b>Product Code</b>	<b>Product Description</b>	<b>Page</b>
SMSH-2267-H	Riverbend – Straight — Triple Seat	.158
SMSM-2228-H	Riverbend – Straight — Single Seat	.156
SMSM-2255-H	Riverbend – Straight — Double Seat	.157
SMSM-2267-H	Riverbend – Straight — Triple Seat	.158
SMSN-2028-H	Riverbend – Straight — Single Seat	.156
SMSN-2055-H	Riverbend – Straight — Double Seat	.157
SMSN-2067-H	Riverbend – Straight — Triple Seat	.158
SMVH-2258-HS	Riverbend – Curved — Convex — 60° Convex	.161
SMVM-2258-HS	Riverbend – Curved — Convex — 60° Convex	.161
SODB-2424-P	Openest – Sprig Tables — Round	.171
SODC-1616-P	Openest – Sprig Tables — Round	.171
SON-3	Openest – Plume Screens — Plume 3	.166
SON-6	Openest – Plume Screens — Plume 6	.166
SON-9	Openest – Plume Screens — Plume 9	.166
SOPB-2223	Openest – Chick Pouf — Chick Pouf with Back	.168
SOPH-2223	Openest – Chick Pouf — Chick Pouf without Back	.168
SOPN-2238	Openest – Chick Pouf — Large Square – No Back	.169
SOPN-2252	Openest – Chick Pouf — Rectangle – No Back	.169
SOPN-2265	Openest – Chick Pouf — Round – No Back	.170
SORA-5320-P	Openest – Sprig Tables — Rectangle	.171
SOSR-1-RN	Openest – Feather Sofa — Feather – Asymmetrical	.167
SOSS-1-RN	Openest – Feather Sofa — Feather – Symmetrical	.167
SPG-11-4	Poppy – Guest — Four Star Base with Glides	.173
SPG-11-5	Poppy – Guest — Five Star Base with Casters	.174
SPG-11-7	Poppy – Guest — Sled Base	.175
SPG-11-W	Poppy – Guest — Wood Base	.175
SRA-1	Resonate — Modular Lounge – Modular Lounge — Alignment Clip	.147
SRC-22	Resonate — Side Chair – Side Chair	.148
SRC-LL	Resonate — Side Chair – Side Chair	.148
SRL-22	Resonate — Lounge Chair – Lounge Chair	.149
SRL-LL	Resonate — Lounge Chair – Lounge Chair	.149
SRMB	Resonate — Modular Lounge – Modular Lounge — Straight Back — Back/No Arms	.144
SRML	Resonate — Modular Lounge – Modular Lounge — Corner — Left/Right Hand	.143
SRMR	Resonate — Modular Lounge – Modular Lounge — Corner — Left/Right Hand	.143
SRON	Resonate — Modular Lounge – Modular Lounge — Ottoman	.145
SRTL	Resonate — Modular Lounge – Modular Lounge — Table	.146
STS-1	Tilt – Stool	.189
STSN-2025-HN	Pebble – Ottoman	.163
STSN-2033-HN	Pebble – Ottoman	.163
STSN-2047-HN	Pebble – Ottoman	.163
STSN-2067-HN	Pebble – Ottoman	.163
SWYL	Wyn – Lounge Chair	.179
SZG-22-1	Zody – 4 Leg	.61
SZG-22-1	Zody – Sled Base	.60
SZT-20-002MA1	Zody – Task Chair	.56
SZT-20-402MA1	Zody – Task Chair	.56
SZT-20-702MA1	Zody – Task Chair	.56
SZTC-20-002MA1	Zody – Task Stool	.58
SZTC-20-402MA1	Zody – Task Stool	.58
SZTC-20-702MA1	Zody – Task Stool	.58
TQ84-0011	ToDo – Upholstered Chair	.188
TQ85-0011	ToDo – Upholstered Chair	.188

# Index

---

<u>Product Code</u>	<u>Product Description</u>	<u>Page</u>
USM-PFOW-1100	Riverbend Power Module – Corded .....	.165
USM-PL0W-1100	Riverbend Power Module – Corded .....	.165
X640-0040	X99 – Seminar Chair .....	.122
X640-0140	X99 – Seminar Chair .....	.122
X641-2040	X99 – Advanced Seminar Chair .....	.123
X641-2140	X99 – Advanced Seminar Chair .....	.123

# Product Compatibility and Limited Warranty Policy

## Great Expectations

You have them as a Haworth customer and so do we. And because we value our customers, we cover our products with the Haworth North America Product Compatibility and Limited Warranty Policy.

## Our Commitment To Product Compatibility – Integrated Product Platforms

As a market leader in the design and manufacture of workspaces that adapt to change, we strive to maintain product compatibility within our various generations of integrated product platforms. This benefits the customer who desires to update or modify their work environment. It also benefits the customer needing to replace a product due to damage or other reasons but which is no longer manufactured or is otherwise unavailable, such as a fabric or finish that is discontinued because of changing market preferences. In both circumstances, we often can provide products with comparable function and performance.

## Our Commitment To Product Quality – The Haworth North America Limited Warranty

To ensure customer satisfaction and peace of mind, we stand behind our products with the Haworth North America Limited Warranty. To review the current version of the limited warranty including its terms and conditions, please go to:

**[www.haworth.com/warranty](http://www.haworth.com/warranty) or contact [OneTouch@Haworth.com](mailto:OneTouch@Haworth.com) or 1 877 429 6784.**

## Warranty Requests or Questions

For questions or service requests pertaining to the Haworth Limited Warranty, please contact your Haworth dealer.

If you are unsure who your dealer is, please contact **[OneTouch@Haworth.com](mailto:OneTouch@Haworth.com) or 1 877 429 6784.**

# Terms of Sale

The Terms of Sale apply to all products in the North America Price Lists. To review the current version of the North American Terms of Sale, please go to:

**[www.haworth.com/terms-of-sale](http://www.haworth.com/terms-of-sale) or contact [OneTouch@Haworth.com](mailto:OneTouch@Haworth.com) or 1 877 429 6784.**

# HAWORTH

HAWORTH® is a registered trademark of Haworth, Inc.  
© Haworth, Inc. All rights reserved. 2025 12.25  
haworth.com | 800 344 2600