

Intuity Benching

North America Price List – December 2025





This Haworth North American price book contains US list prices.

Canadian customers can convert the US list price into their Canadian equivalent by going to www.Haworth.com/Canada to find the current Canadian multipliers. These multiplier factors allow you to convert the US list price into a Canadian list price.

Haworth Price List Overview

Tips for Using Haworth Price Lists

The following overview explains how information is organized within the Intuity® Benchmarking price list.

Navigation Links

Use the links to jump back and forth to relevant pages.

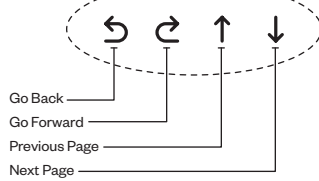

Modular Lower Storage
2H Slim Pedestal - Attached

Personal Drawer/Open

Features

- Available in 18" and 24" pedestal widths and pedestal widths with 18" and 24" depth drawers.
- Available in 18" and 24" pedestal widths and pedestal widths with 18" and 24" depth drawers.
- Available in 18" and 24" pedestal widths and pedestal widths with 18" and 24" depth drawers.

Specification Tips

For full options, refer to the Link Program section of the Accountant Price List.

Height	Depth	Width	Number	Case Grade A Front Grade		Case Grade B Front Grade	
				A	B	A	B
24" (610mm)	18" (457mm)	18" (457mm)	10	885.00	825.00	825.00	765.00
24" (610mm)	18" (457mm)	24" (610mm)	10	985.00	925.00	925.00	865.00
24" (610mm)	24" (610mm)	18" (457mm)	10	1085.00	1025.00	1025.00	965.00
24" (610mm)	24" (610mm)	24" (610mm)	10	1185.00	1125.00	1125.00	1065.00

Haworth Price Books are organized into the following sections:

Price List Section

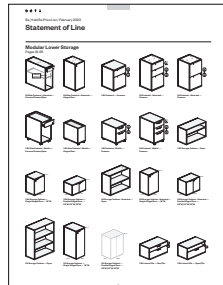

Statement of Line
Provides a visual overview of the product offering.

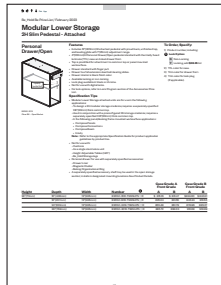

Price List
Includes product features, specification tips, catalog numbers and list pricing.

Resources Section

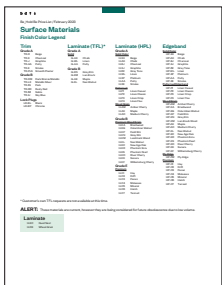

Finishes and Fabrics
Lists available product finishes and fabrics.

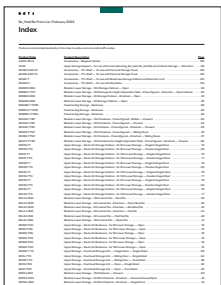

Index
Lists products alphabetically by catalog number.



Warranty and Terms of Sale
Provides warranty information and general terms.



This Page Intentionally Left Blank

Intuity Benching Price List

Includes pricing, catalog numbers, finish codes/availability, specification requirements, line art, dimensions, and specification tips for Intuity® Benching.

Kits

Leg Kits

Worksurfaces

Accessories

Electrical Components

Electrical Accessories

Table of Contents

Price List

Statement of Line	7
Single Sided Kits	
Single Sided Starter Kit	9
Single Sided Add-On Kit	10
Double Sided Kits	
Double Sided Starter Kit	11
Double Sided Add-On Kit	13
120° Single Sided Starter Kits	
120° Single Sided Starter Kit	15
120° Double Sided Three Pack Starter Kit	
120° Double Sided Three Pack Starter Kit	16
120° Double Sided Three Pack Add-on Kit	
120° Double Sided Three Pack Add-on Kit	17
Leg Kits	
Bench End Leg Kit	18
Return Leg Kit	18
Worksurfaces	
Rectangular Worksurface — No Access Hatch	19
Rectangular Worksurface – For Use with Access Hatches	20
Rectangular Bench End Worksurface	21
Rectangular Return Worksurface	21
Corner, 120° Wrap-Around	22
Accessories	
Tie Plate	23
Double-Sided Utility Tray End Covers	23
120° Infeed Cover	23
Access Hatch Gap Filler	23
Electrical Components	
Infeed Harness	24
Base Feed Module — Hardwire Connection	24
Single Circuit Base Feed – Receptacle Connection with Power Cord — 3-Circuit and 4-Circuit	25
Single Circuit Base Feed – Receptacle Connection — 3-Circuit and 4-Circuit	25
Base Feed Module Hardwire Connection	26
Internal Power Base™ AI Base Feed	26
Jumper	27
Utility Tray Power Retrofit Kit	27
Top Feed	28
Triplex Receptacle – 15 Amp	29
Triplex Receptacle – 20 Amp	30
Top Feed — Hardwire	31
Hardwire Kit	31
Cover Plates	31
Electrical Accessories	
Base Feed Cover — Vertical	32
Resources	
Surface Materials	
Finish/Color Legend	34
Vertical Fabrics/Color Legend	35
Index	36
Lifetime Product Warranty	Inside Back Cover

Statement of Line

Kits

Pages 9-17

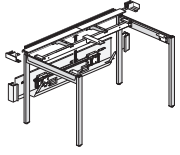

Single Sided Starter Kit — Straight Leg

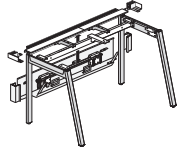

Single Sided Starter Kit — Angled Leg

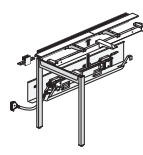

Single Sided Add-On Kit — Straight Leg

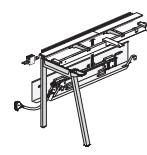

Single Sided Add-On Kit — Angled Leg

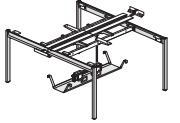

Double Sided Starter Kit — Straight Leg

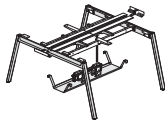

Double Sided Starter Kit — Angled Leg

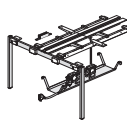

Double Sided Add-On Kit — Straight Leg

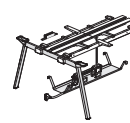

Double Sided Add-On Kit — Angled Leg

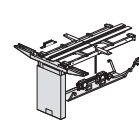

Double Sided Add-On Kit — Column Leg



120° Single Sided Starter Kit — Straight Leg

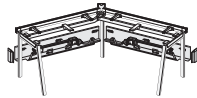

120° Single Sided Starter Kit — Angled Leg

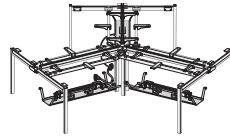

120° Double Sided Three Pack Starter Kit — Straight Leg



120° Double Sided Three Pack Starter Kit — Angled Leg

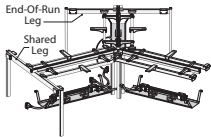

120° Double Sided Three Pack Add-on Kit

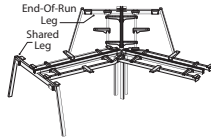

120° Double Sided Three Pack Add-on Kit

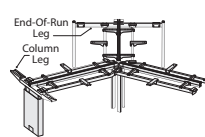

120° Double Sided Three Pack Add-on Kit

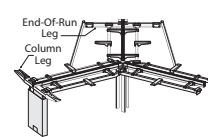

120° Double Sided Three Pack Add-on Kit

Leg Kits

Page 18

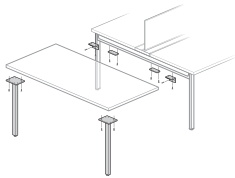

Bench End Leg Kit — Straight

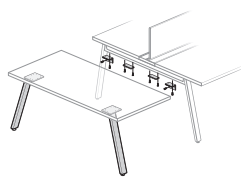

Bench End Leg Kit — Angled

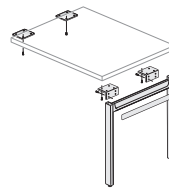

Return Leg Kit — Straight

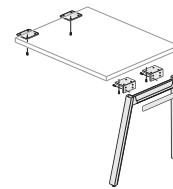

Return Leg Kit — Angled

Worksurfaces

Pages 19-22

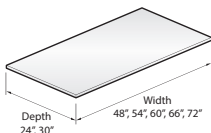

Rectangular Worksurface — No Access Hatch

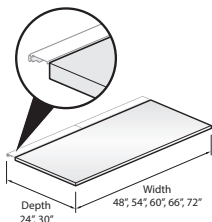

Rectangular Worksurface — For Use with Access Hatches

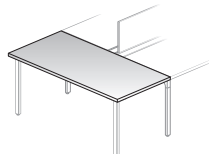

Rectangular Bench End Worksurface

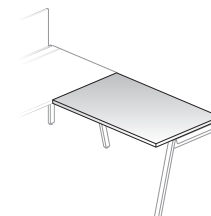

Rectangular Return Worksurface

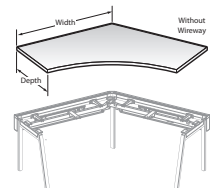

Corner, 120° Wrap-Around Worksurface

Statement of Line

Accessories

Page 23

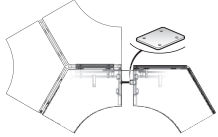

Tie Plate

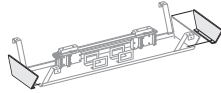

Double-Sided Utility Tray End Covers

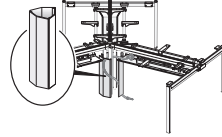

120° Infeed Cover

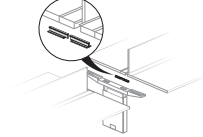

Access Hatch Gap Filler

Electrical Components

Pages 24-31

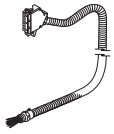

Infeed Harness

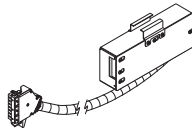

Base Feed Module — Architectural Concealed Hardwire Connection

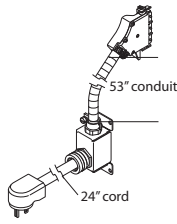

Single Circuit Base Feed — Receptacle Connection with Power Cord — 3-Circuit and 4-Circuit

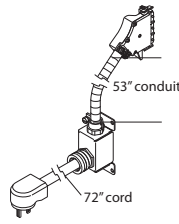

Single Circuit Base Feed — Receptacle Connection — 3-Circuit and 4-Circuit

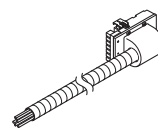

Base Feed Module Hardwire Connection

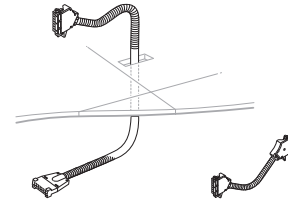

Internal Power Base™ AI Base Feed

Jumper



Utility Tray Power Retrofit Kit

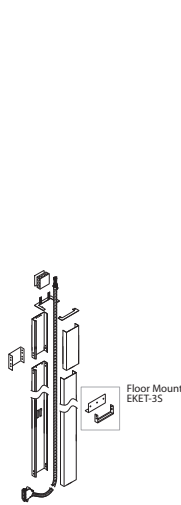

Top Feed

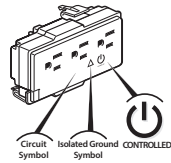

Triplex Receptacles — 15 AMP

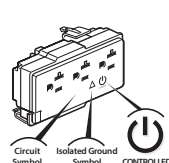

Triplex Receptacles — 20 AMP

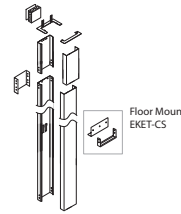
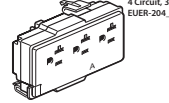
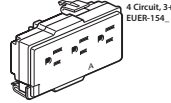
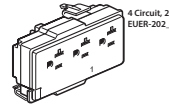
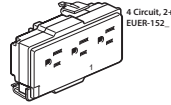
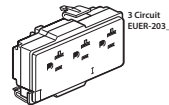
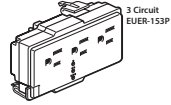

Top Feed — Hardwire



Cover Plates

Electrical Accessories

Page 32

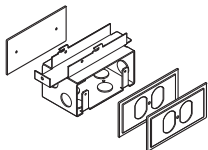

Hardwire Kit



Cover Plates

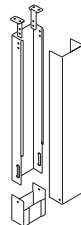

Base Feed Cover — Vertical Fixed Height

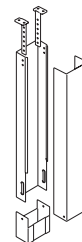

Base Feed Cover — Vertical Adjustable Height

Single Sided Kits

Single Sided Starter Kit

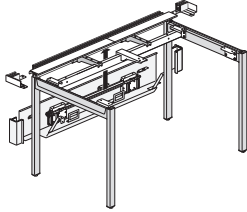

Straight Leg
ZBRA-2448-SIGH

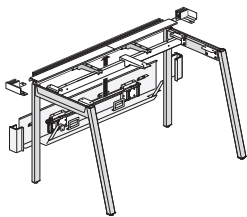

Angled Leg
ZBRA-2448-SAGH
(Shown with 3- or 4-circuit power and access hatches)
Class IN

Features

- Includes two fixed-height steel leg assemblies, support beam, rail, worksurface support brackets, and integrated below-surface utility tray. Available with or without the following:
 - Power distribution assembly
 - Full access hatches for back edge of worksurface
- Fixed-height legs are 28"(711mm) to bottom of worksurface with glides fully recessed.
- Glides provide 0.5"(13mm) leveling adjustment.
- Leg accent plate is located in the top center section of each leg assembly and allows for a user-specified accent color for aesthetic purposes.
- Access hatch option includes two hinged doors that extend the full width of the surface for easy access to power distribution assembly and utility tray. The doors are 4.25"(108mm)D and provide a 1"(25mm) gap between the hatch and worksurface.
- Field assembled

Specification Tips

- For **in-line** benching applications only; not for return benching applications.
- A Single Sided Starter Kit may be used as a stand alone desk.
- Requires Single Sided Add-On Kit(s) for an in-line single sided benching application. Leg from the Single Sided Starter Kit is repositioned to the end-of-run.
- For use with Intuity worksurface, specified separately.
 - Surface depth must match depth of the add-on kit.
 - Kit with no access hatches, option (-C) supports a rectangular worksurface.
 - Kit with access hatches, option (-S) supports a rectangular worksurface for use with access hatches.
- Angled Legs are required for Knife Edge worksurface option.
- Rail features an inset channel for use with Intuity Screens, Belong Plus Screens and Active Components Center Screens.
- Single Sided Starter Kit is always standard with utility tray in a powered or non-powered application.
- Below worksurface power access is standard with 3-circuit, 4-circuit or hardwire power option.
- In 3- and 4-circuit power applications the Power Distribution Assembly (PDA) will accept a maximum of two separately specified triplex receptacles.
- Hardwire power option (-C) includes two junction boxes; conduit is field supplied.
- Separately specify electrical components for **in** and **out** power path. Do not mix 3-circuit with 4-circuit components. Do not mix 2+2 and 3+1 components.

To Order, Specify:

1) Product number, including:

1 Leg Type:

- I** Straight Leg
- A** Angled Leg

2 Power Type:

- N** Non-Powered
- 3** 3-Circuit, see chart for upcharge
- 2** 4-Circuit, 2+2, see chart for upcharge
- 4** 4-Circuit, 3+1, see chart for upcharge
- C** Hardwire, see chart for upcharge

3 Access Hatches:

- C** No Access Hatches
- S** Access Hatches
(add Trim A: **\$241.07** list
Trim B: **\$259.07** list)

2) Leg color*.

3) Accent plate color*.

4) Universal rail/utility tray color*.

5) Access hatch color*
(if applicable).

***Note:** Upcharge for mixed grade trim surfaces; refer to the electronic design and specification tools for pricing.

2 Power Type

Width	3-Circuit	4-Circuit, 2+2	4-Circuit, 3+1	Hardwire
48"	\$136.36	\$ 183.63	\$ 183.63	\$ 373.81
54"	147.12	196.54	196.54	389.93
60"	157.88	209.45	209.45	406.05
66"	168.64	222.36	222.36	422.17
72"	179.40	235.27	235.27	438.29

Depth	Width	Number	Trim				
			1	2	3	A	B
24"(610mm)	48"(1219mm)	ZBRA-2448-S	GHP	T		\$ 1735.17	\$ 1787.10
	54"(1372mm)	ZBRA-2454-S	GHP	T		1762.06	1813.99
	60"(1524mm)	ZBRA-2460-S	GHP	T		1788.95	1840.88
	66"(1676mm)	ZBRA-2466-S	GHP	T		1815.84	1867.77
	72"(1829mm)	ZBRA-2472-S	GHP	T		1842.73	1894.66
30"(762mm)	48"(1219mm)	ZBRA-3048-S	GHP	T		\$ 1788.90	\$ 1840.83
	54"(1372mm)	ZBRA-3054-S	GHP	T		1815.79	1867.72
	60"(1524mm)	ZBRA-3060-S	GHP	T		1842.68	1894.61
	66"(1676mm)	ZBRA-3066-S	GHP	T		1869.57	1921.50
	72"(1829mm)	ZBRA-3072-S	GHP	T		1896.46	1948.39

Single Sided Kits

Single Sided Add-On Kit

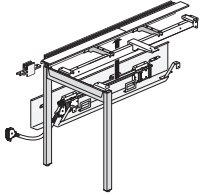

Straight Leg
ZBRA-2448-ATGH

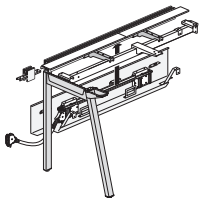

Angled Leg
ZBRA-2448-ASGH
(Shown with 3- or 4-circuit power and access hatches)
Class IN

Features

- Includes one shared, fixed-height steel leg assembly support beam, rail, worksurface support brackets, and integrated below-surface utility tray. Available with or without the following:
 - Power distribution assembly and power jumper
 - Full-width access hatches for back edge of worksurface
- Integrated utility tray on non-powered starter rails provides cable management and routing only.
- Attaches to a Single Sided Starter Kit, or to another Add-On Kit to extend the overall length of the bench.
- Fixed-height legs are 28"(711mm) to bottom of worksurface with glides fully recessed.
- Glides provide 0.5"(13mm) leveling adjustment.
- Power distribution assembly provides locations for two separately specified triplex receptacles, providing below-surface power access at the back edge.
- A power jumper is included to connect adjacent power distribution assemblies.
- Access hatch option includes two hinged doors that extend the full width of the surface for easy access to power distribution assembly and utility tray. The doors are 4.25"(108mm)D and provide a 1"(25mm) gap between the hatch and worksurface.
- Field assembled

Specification Tips

- For **in-line** benching applications only; not for return benching applications.
- Requires Single Sided Starter Kit for an in-line, single sided benching application. Leg from the Single Sided Starter Kit is repositioned to end of run.
- Multiple Single Sided Add-On Kits may be used with one Single Sided Starter Kit.
- For use with Intuity worksurface, specified separately.
 - Surface depth must match depth of the add-on kit.
 - Kit with no access hatches, option (-C) supports a rectangular worksurface.
 - Kit with access hatches, option (-S) supports a rectangular worksurface for use with access hatches.
- Angled Legs are required for Knife Edge worksurface option.
- Rail features an inset channel for use with Intuity Screens, Belong Plus Screens and Active Components Center Screens.
- Single Sided Add-On Kit is always standard with utility tray in a powered or non-powered application.
- Below worksurface power access is standard with 3-circuit, 4-circuit or hardwire power option.
- In 3- and 4-circuit power applications the Power Distribution Assembly (PDA) will accept a maximum of two separately specified triplex receptacles.
- Hardwire power option (-C) includes two junction boxes; conduit is field supplied.
- Separately specify electrical components for **in** and **out** power path. Do not mix 3-circuit with 4-circuit components. Do not mix 2+2 and 3+1 components.

To Order, Specify:

1) Product number, including:

1 Leg Type:

- T** Straight Leg
- S** Angled Leg

2 Power Type:

- N** Non-Powered
- 3** 3-Circuit, see chart for upcharge
- 2** 4-Circuit, 2+2, see chart for upcharge
- 4** 4-Circuit, 3+1, see chart for upcharge
- C** Hardwire, see chart for upcharge

3 Access Hatches:

- C** No Access Hatches
- S** Access Hatches
(add Trim A: **\$241.07** list
Trim B: **\$259.07** list)

2) Leg color*.

3) Universal rail/utility tray color*.

4) Access hatch color*
(if applicable).

***Note:** Upcharge for mixed grade trim surfaces; refer to the electronic design and specification tools for pricing.

2 Power Type

Width	3-Circuit	4-Circuit, 2+2	4-Circuit, 3+1	Hardwire
48"	\$136.36	\$ 183.63	\$ 183.63	\$ 373.81
54"	147.12	196.54	196.54	389.93
60"	157.88	209.45	209.45	406.05
66"	168.64	222.36	222.36	422.17
72"	179.40	235.27	235.27	438.29

Depth	Width	Number				Trim	
			1	2	3	A	B
24"(610mm)	48"(1219mm)	ZBRA-2448-A	GHN	T		\$ 1412.58	\$1455.54
	54"(1372mm)	ZBRA-2454-A	GHN	T		1439.47	1482.43
	60"(1524mm)	ZBRA-2460-A	GHN	T		1466.36	1509.32
	66"(1676mm)	ZBRA-2466-A	GHN	T		1493.25	1536.21
	72"(1829mm)	ZBRA-2472-A	GHN	T		1520.14	1563.10
30"(762mm)	48"(1219mm)	ZBRA-3048-A	GHN	T		\$1448.39	\$ 1491.35
	54"(1372mm)	ZBRA-3054-A	GHN	T		1475.28	1518.24
	60"(1524mm)	ZBRA-3060-A	GHN	T		1502.17	1545.13
	66"(1676mm)	ZBRA-3066-A	GHN	T		1529.06	1572.02
	72"(1829mm)	ZBRA-3072-A	GHN	T		1555.95	1598.91

Double Sided Kits

Double Sided Starter Kit

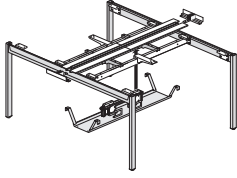

Straight Leg
ZBRA-4848-SIGH

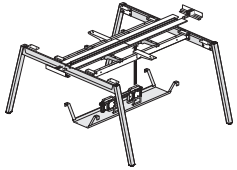

Angled Leg
ZBRA-4848-SAGH
(Shown with Utility Tray, 3- or 4-circuit power and access hatches)
Class IN

Features

- Includes two fixed-height steel leg assemblies, two support beams, rail, and surface support brackets. Available with or without the following:
 - Power distribution assembly
 - Below-surface utility tray; standard in charcoal
 - Full-width access hatches for back edge of worksurfaces
- Fixed-height legs are 28"(711mm) to bottom of worksurface with glides fully recessed.
- Glides provide 0.5"(13mm) leveling adjustment.
- Leg accent plate is located in the top center section of each leg assembly and allows for a user-specified accent color for aesthetic purposes.
- Power distribution assembly provides locations for four separately specified triplex receptacles (2 on each side), providing below-surface power access at the back edge of each worksurface.
- Access hatch option includes four hinged doors (two on each side) that extend the full width of the surfaces for easy access to power distribution assembly and utility tray. The doors are 4.25"(108mm)D and provide a 1"(25mm) gap between the hatch and worksurface.
- Field assembled.

Specification Tips

- For **in-line** benching applications only; not for return benching applications.
- Requires Double Sided Add-On Kit(s) for an in-line double sided benching application. Leg from the Double Sided Starter Kit is repositioned to the end-of-run.
- For use with Intuity worksurfaces, specified separately.
 - 24"(610mm)D surfaces must be used with 48"(1219mm)D Double Sided Starter Kits, and 30"(762mm)D surfaces must be used with 60"(1524mm)D Double Sided Starter Kits.
 - Kit with no access hatches, option (-C) supports rectangular worksurfaces.
 - Kit with access hatches, option (-S) supports rectangular worksurfaces for use with access hatches.
- Angled Legs are required for Knife Edge worksurface option.
- Rail features an inset channel for use with Intuity Screens, Belong Plus Screens and Active Components Center Screens.
- Below worksurface utility tray is optional for a non-powered application. Recommended if below worksurface cable management is needed.
- Below worksurface power access is standard with -3, -4 circuit or hardwire power option.
- In 3- and 4-circuit power applications the Power Distribution Assembly (PDA) will accept a maximum of four separately specified triplex receptacles; two per each side of Double Sided Starter Kit.
- Hardwire power option (-C) includes two junction boxes; conduit is field supplied.
- Separately specify electrical components for **in** and **out** power path. Do not mix 3-circuit with 4-circuit components. Do not mix 2+2 and 3+1 components.

To Order, Specify:

1) Product number, including:

1 Leg Type:

- I** Straight Leg
- A** Angled Leg

2 Power Type:

- N** Non-Powered
- 3** 3-Circuit, see chart for upcharge
- 2** 4-Circuit, 2+2, see chart for upcharge
- 4** 4-Circuit, 3+1, see chart for upcharge
- C** Hardwire, see chart for upcharge

3 Access Hatches:

- C** No Access Hatches
- S** Access Hatches
(add Trim A: **\$482.14** list
Trim B: **\$500.14** list)

2) Leg color*.

3) Accent plate color*.

4) Universal rail color*.

5) Access hatch color*
(if applicable).

***Note:** Upcharge for mixed grade trim surfaces; refer to the electronic design and specification tools for pricing.

2 Power Type for Utility Tray

Width	3-Circuit	4-Circuit, 2+2	4-Circuit, 3+1	Hardwire
48"	\$ 215.89	\$ 279.07	\$ 279.07	\$ 373.81
54"	226.65	291.98	291.98	389.93
60"	237.41	304.89	304.89	406.05
66"	248.17	317.80	317.80	422.16
72"	258.93	330.71	330.71	438.29

Double Sided Kits

Depth	Width	Number ① ② ③	Trim	
			A	B
No Utility Tray				
48"(1219mm)	48"(1219mm)	ZBRA-4848-S GHPNN	\$ 1699.52	\$ 1751.45
	54"(1372mm)	ZBRA-4854-S GHPNN	1717.44	1769.37
	60"(1524mm)	ZBRA-4860-S GHPNN	1735.36	1787.29
	66"(1676mm)	ZBRA-4866-S GHPNN	1753.28	1805.21
	72"(1829mm)	ZBRA-4872-S GHPNN	1771.20	1823.13
60"(1524mm)	48"(1219mm)	ZBRA-6048-S GHPNN	\$ 1753.25	\$ 1805.18
	54"(1372mm)	ZBRA-6054-S GHPNN	1771.17	1823.10
	60"(1524mm)	ZBRA-6060-S GHPNN	1789.09	1841.02
	66"(1676mm)	ZBRA-6066-S GHPNN	1807.01	1858.94
	72"(1829mm)	ZBRA-6072-S GHPNN	1824.93	1876.86
Utility Tray				
48"(1219mm)	48"(1219mm)	ZBRA-4848-S GHP T	\$ 1932.29	\$ 1984.22
	54"(1372mm)	ZBRA-4854-S GHP T	1968.13	2020.06
	60"(1524mm)	ZBRA-4860-S GHP T	2003.97	2055.90
	66"(1676mm)	ZBRA-4866-S GHP T	2039.81	2091.74
	72"(1829mm)	ZBRA-4872-S GHP T	2075.65	2127.58
60"(1524mm)	48"(1219mm)	ZBRA-6048-S GHP T	\$ 1986.02	\$ 2037.95
	54"(1372mm)	ZBRA-6054-S GHP T	2021.86	2073.79
	60"(1524mm)	ZBRA-6060-S GHP T	2057.70	2109.63
	66"(1676mm)	ZBRA-6066-S GHP T	2093.54	2145.47
	72"(1829mm)	ZBRA-6072-S GHP T	2129.38	2181.31

Double Sided Kits

Double Sided Add-On Kit

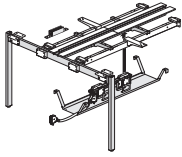

Straight Leg
ZBRA-4848-ATGH

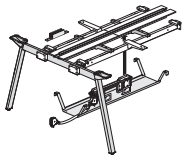

Angled Leg
ZBRA-4848-ASGH

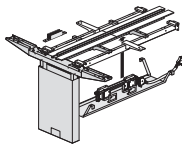

Column Leg
ZBRA-4848-AFGH
(Shown with Utility Tray, 3- or 4-circuit power and access hatches)
Class IN

Features

- Includes one shared, fixed-height steel leg assembly or column, two support beams, rail, and surface support brackets.
Available with or without the following:
 - Power distribution assembly and power jumper
 - Below-surface utility tray; standard in charcoal
 - Full-width access hatches for back edge of worksurfaces
- Attaches to a Double Sided Starter Kit, or to another add-on rail to extend the overall length of the bench.
- Fixed-height legs are 28" (711mm) to bottom of worksurface with glides fully recessed.
- Glides provide 0.5" (13mm) leveling adjustment.
- Column leg option provides an enclosed cavity and removable cover for routing power up from the floor. Column leg is 13" (330mm) D x 3" (76mm) W on the inside and D x 3.15" (80mm) W on the outside.
- Power distribution assembly provides locations for four separately specified triplex receptacles (two on each side), providing below-surface power access at the back edge of each worksurface.
- A power jumper is included to connect adjacent power distribution assemblies.
- Access hatch option includes four hinged doors (two on each side) that extend the full width of the surfaces for easy access to power distribution assembly and utility tray. The doors are 4.25" (108mm) D and provide a 1" (25mm) gap between the hatch and worksurface.
- Field assembled.

Specification Tips

- For **in-line** benching applications only; not for return benching applications.
- Requires Double Sided Starter Kit for an in-line double sided benching application. Leg from the Double Sided Starter Kit is repositioned to end of run.
- Multiple Double Sided Add-On Kits may be used with one Double Sided Starter Kit.
- For use with Intuity worksurfaces, specified separately.
 - 48" (1219mm) D kits require 24" (610mm) D worksurfaces
 - 60" (1524mm) D kits require 30" (762mm) D worksurfaces
 - Kit with no access hatches, option (-C) supports rectangular worksurfaces.
 - Kit with access hatches, option (-S) supports rectangular worksurfaces for use with access hatches.
- Angled Legs are required for Knife Edge worksurface option.
- Column Leg provides intermediate shared support, additional knee clearance, and power and cable management.
- Rail features an inset channel for use with Intuity Screens, Belong Plus Screens and Active Components Center Screens.
- Below worksurface utility tray is optional for a non-powered application. Recommended if below worksurface cable management is needed.
- Below worksurface power access is standard with -3, -4 circuit or hardwire power option.
- In 3- and 4- circuit power applications the Power Distribution Assembly (PDA) will accept a maximum of four separately specified triplex receptacles; two per each side of Double Sided Starter Kit.
- Hardwire power option (-C) includes two junction boxes; conduit is field supplied.
- Separately specify electrical components for in and out power path. Do not mix 3-circuit with 4-circuit components. Do not mix 2+2 and 3+1 components.

To Order, Specify:

1) Product number, including:

1 Leg Type:

- T** Straight Leg
- S** Angled Leg
- F** Column Leg
(add **\$364.70** list)

2 Power Type:

- N** Non-Powered
- 3** 3-Circuit, see chart for upcharge
- 2** 4-Circuit, 2+2, see chart for upcharge
- 4** 4-Circuit, 3+1, see chart for upcharge
- C** Hardwire, see chart for upcharge

3 Access Hatches:

- C** No Access Hatches
- S** Access Hatches
(add Trim A: **\$482.15** list
Trim B: **\$500.14** list)

2) Leg color*.

3) Universal rail color*.

4) Access hatch color*
(if applicable).

***Note:** Upcharge for mixed grade trim surfaces; refer to the electronic design and specification tools for pricing.

2 Power Type for Utility Tray

Width	3-Circuit	4-Circuit, 2+2	4-Circuit, 3+1	Hardwire
48"	\$ 215.89	\$ 279.07	\$ 279.07	\$ 373.81
54"	226.65	291.98	291.98	389.93
60"	237.41	304.89	304.89	406.05
66"	248.17	317.80	317.80	422.16
72"	258.93	330.71	330.71	438.29

Double Sided Kits

Depth	Width	Number ① ② ③	Trim	
			A	B
No Utility Tray				
48"(1219mm)	48"(1219mm)	ZBRA-4848-A GHNNN	\$1265.92	\$1308.88
	54"(1372mm)	ZBRA-4854-A GHNNN	1283.84	1326.80
	60"(1524mm)	ZBRA-4860-A GHNNN	1301.76	1344.72
	66"(1676mm)	ZBRA-4866-A GHNNN	1319.68	1362.64
	72"(1829mm)	ZBRA-4872-A GHNNN	1337.60	1380.56
60"(1524mm)	48"(1219mm)	ZBRA-6048-A GHNNN	\$ 1301.73	\$1344.69
	54"(1372mm)	ZBRA-6054-A GHNNN	1319.65	1362.61
	60"(1524mm)	ZBRA-6060-A GHNNN	1337.57	1380.53
	66"(1676mm)	ZBRA-6066-A GHNNN	1355.49	1398.45
	72"(1829mm)	ZBRA-6072-A GHNNN	1373.41	1416.37
Utility Tray				
48"(1219mm)	48"(1219mm)	ZBRA-4848-A GHN T	\$1498.69	\$ 1541.65
	54"(1372mm)	ZBRA-4854-A GHN T	1534.53	1577.49
	60"(1524mm)	ZBRA-4860-A GHN T	1570.37	1613.33
	66"(1676mm)	ZBRA-4866-A GHN T	1606.21	1649.17
	72"(1829mm)	ZBRA-4872-A GHN T	1642.05	1685.01
60"(1524mm)	48"(1219mm)	ZBRA-6048-A GHN T	\$1534.50	\$ 1577.46
	54"(1372mm)	ZBRA-6054-A GHN T	1570.34	1613.30
	60"(1524mm)	ZBRA-6060-A GHN T	1606.18	1649.14
	66"(1676mm)	ZBRA-6066-A GHN T	1642.02	1684.98
	72"(1829mm)	ZBRA-6072-A GHN T	1677.86	1720.82

120° Single Sided Starter Kits

120° Single Sided Starter Kit

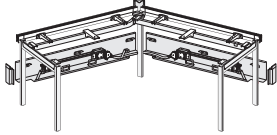

ZBCZ-2442-SIGH

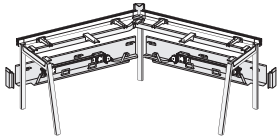

ZBCZ-2442-SAGH
Class IN

Features

- Includes two fixed-height steel leg assemblies, two support beams, one center post leg, two rails, worksurface support brackets, integrated below surface utility tray and 120° single corner cap.
- Available with or without the following:
 - Power Distribution Assemblies (2) and Flex Connector (1).
- Fixed height legs are 28”(711mm) to bottom of worksurface with glides fully recessed.
- Glides provide 0.5”(13mm) leveling adjustment.
- Leg accent plate is located in the top center section of each leg assembly and allows for a user-specified accent color for aesthetic purposes.
- Field assembled.

Specification Tips

- May be used as a stand alone desk.
- Requires Single Sided Add-On Kit(s) for an in-line single sided benching application. Leg from the 120° Single Sided Starter Kit is repositioned to the end-of-run.
- Not for use in a return benching position.
- For use with Intuity 120° worksurface; specified separately.
- Access Hatch not available on 120° kits.
- Angled legs required for knife edge worksurface option.
- Rail features an inset channel for use with Intuity Screens, Belong Plus Screens or Active Components Center Screens.
- 120° Single Sided Kit is always standard with utility tray in a powered or non-powered application.
- 3-circuit, 4-circuit or hardwire power options are standard with below worksurface power access location.
- In 3- and 4-circuit power applications the Power Distribution Assembly (PDA) will accept a maximum of four separately specified triplex receptacles.
- Hardwire power option (-C) includes four junction boxes; conduit is field supplied.
- Separately specify electrical components for in and out power path.
- Do not mix 3-circuit with 4-circuit components. Do not mix 2+2 and 3+1 components. Components have unique polarity key and color coding (3-circuit=black, 2+2=blue and 3+1=green).

To Order, Specify:

1) Product number, including:

1 Leg Type:

- I** Straight Leg
- A** Angled Leg

2 Power Type:

- N** Non-Powered
- 3** 3-Circuit, see chart for upcharge
- 2** 4-Circuit, 2+2, see chart for upcharge
- 4** 4-Circuit, 3+1, see chart for upcharge
- C** Hardwire, see chart for upcharge

2) Leg color*.

3) Accent plate color*.

4) Universal rail/utility tray/120° single corner cap color*.

***Note:** Upcharge for mixed grade trim surfaces; refer to the electronic design and specification tools for pricing.

2 Power Type

Width	3-Circuit	4-Circuit, 2+2	4-Circuit, 3+1	Hardwire
42"	\$146.21	\$146.21	\$146.21	\$492.26
48"	164.13	164.13	164.13	524.49
54"	182.05	182.05	182.05	556.72

Depth	Width	Number	1		2		Trim	
			GHP	TC	A	B		
24”(610mm)	42”(1067mm)	ZBCZ-2442-S	GHP	TC	\$4029.39	\$4059.84		
	48”(1219mm)	ZBCZ-2448-S	GHP	TC	4167.83	4198.28		
	54”(1372mm)	ZBCZ-2454-S	GHP	TC	4306.27	4336.72		
30”(762mm)	42”(1067mm)	ZBCZ-3042-S	GHP	TC	\$4442.67	\$4473.12		
	48”(1219mm)	ZBCZ-3048-S	GHP	TC	4581.11	4611.56		
	54”(1372mm)	ZBCZ-3054-S	GHP	TC	4719.55	4750.00		

120° Double Sided Three Pack Starter Kit

120° Double Sided Three Pack Starter Kit

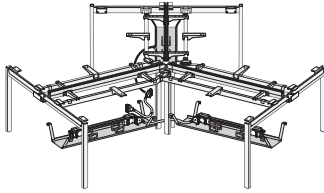

ZBCZ-4842-SIGH

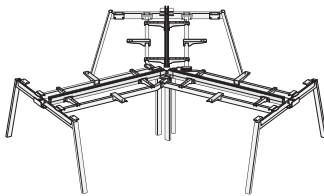

ZBCZ-4842-SAGH

Class IN

Features

- Includes three fixed-height steel leg assemblies, three center post legs, six support beams, three rails, worksurface support brackets and 120° three-way cap.
- Available with or without the following:
 - Power Distribution Assemblies (3) and Flex Connectors (2).
 - Below-surface utility tray; standard in charcoal. Powered application always includes utility tray. Optional for non-powered application only.
- Fixed height legs are 28"(711mm) to bottom of worksurface with glides fully recessed.
- Glides provide 0.5"(13mm) leveling adjustment.
- Leg accent plate is located in the top center section of each leg assembly and allows for a user-specified accent color for aesthetic purposes.
- Field assembled.

Specification Tips

• For 120° applications.

May be used in the following applications:

- Stand alone desk
- With Double Sided Add-On Kit
- With Double Sided 120° add-on kit
- Requires three separately specified 120° Intuity worksurfaces:
 - 48"(1219mm)D kit require 24"(610mm)D worksurfaces
 - 60"(1524mm)D kit require 30"(762mm)D worksurfaces
- Access Hatch not available on 120° kits.
- Angled legs are required for Knife Edge worksurface option.
- Rail features an inset channel for use with Intuity Screens, Belong Plus Screens and Active Components Center Screens.
- Below worksurface utility tray is optional for a non-powered application but recommended if below worksurface cable management is needed.
- Below worksurface utility tray is standard for 3-circuit, 4-circuit and hardwire options.
- 3- and 4-circuit or hardwire power options are standard with below worksurface power access location.
- In 3- and 4-circuit power applications the Power Distribution Assemblies (PDA) will accept a maximum of twelve separately specified triplex receptacles.
- Hardwire power option (-C) includes six junction boxes; conduit is field supplied.
- Separately specify electrical components for in and out power path.
- Do not mix 3-circuit with 4-circuit components. Do not mix 2+2 and 3+1 components. Components have unique polarity key and color coding (3-circuit=black, 2+2=blue and 3+1=green).

To Order, Specify:

1) Product number, including:

① Leg Type:

- I** Straight Leg
- A** Angled Leg

② Power Type:

- N** Non-Powered
- 3** 3-Circuit, see chart for upcharge
- 2** 4-Circuit, 2+2, see chart for upcharge
- 4** 4-Circuit, 3+1, see chart for upcharge
- C** Hardwire, see chart for upcharge

2) Leg color*.

3) Accent plate color*.

4) Universal rail/utility tray/120° three-way cap color*.

***Note:** Upcharge for mixed grade trim surfaces; refer to the electronic design and specification tools for pricing.

② Power Type

Width	3-Circuit	4-Circuit, 2+2	4-Circuit, 3+1	Hardwire
42"	\$689.71	\$689.71	\$689.71	\$1528.02
48"	707.63	707.63	707.63	1560.25
54"	725.55	725.55	725.55	1592.48

Depth	Width	Number	Trim		
			A	B	
No Utility Tray - Non-Powered					
48"(1219mm)	42"(1067mm)	ZBCZ-4842-S	GHPNNC	\$ 5164.61	\$ 5195.06
	48"(1219mm)	ZBCZ-4848-S	GHPNNC	5285.13	5315.58
	54"(1372mm)	ZBCZ-4854-S	GHPNNC	5405.65	5436.10
60"(1524mm)	42"(1067mm)	ZBCZ-6042-S	GHPNNC	\$ 5991.17	\$ 6021.62
	48"(1219mm)	ZBCZ-6048-S	GHPNNC	6111.69	6142.14
	54"(1372mm)	ZBCZ-6054-S	GHPNNC	6232.21	6262.66
Utility Tray					
48"(1219mm)	42"(1067mm)	ZBCZ-4842-S	GHP TC	\$5544.10	\$ 5574.55
	48"(1219mm)	ZBCZ-4848-S	GHP TC	5718.33	5748.78
	54"(1372mm)	ZBCZ-4854-S	GHP TC	5892.56	5923.01
60"(1524mm)	42"(1067mm)	ZBCZ-6042-S	GHP TC	\$6370.66	\$ 6401.11
	48"(1219mm)	ZBCZ-6048-S	GHP TC	6544.89	6575.34
	54"(1372mm)	ZBCZ-6054-S	GHP TC	6719.12	6749.57

120° Double Sided Three Pack Add-on Kit

120° Double Sided Three Pack Add-on Kit

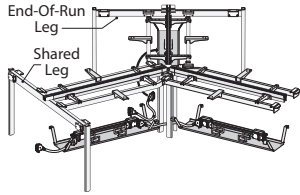

ZBCZ-4842-AWGH

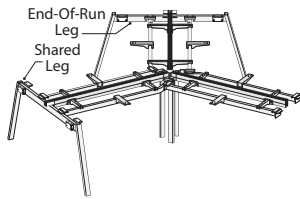

ZBCZ-4842-AYGH

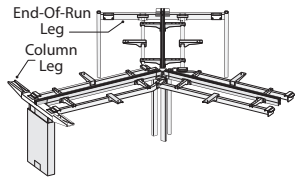

ZBCZ-4842-AXGH

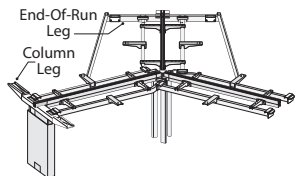

ZBCZ-4842-AZGH

Class IN

Features

- Includes one fixed-height steel leg kit, three center post legs, six support beams, three rails, worksurface support brackets and 120° three way cap.
- Fixed height leg kit includes legs for one shared condition and one end-of-run condition.
- Available with or without the following:
 - Power Distribution Assemblies (3) and Flex Connectors (3).
 - Below-surface utility tray; standard in charcoal. Powered application always includes utility tray. Optional for non-powered application only.
- Fixed height legs are 28”(711mm) to bottom of worksurface with glides fully recessed.
- Glides provide 0.5”(13mm) leveling adjustment.
- Column leg option provides an enclosed cavity and removable cover for routing power up from the floor. Column leg is 13”(330mm)D x 3”(76mm)W on the inside and 15.75”(400mm)D x 3.15”(80mm)W on the outside.
- A power jumper is included to connect to adjacent power distribution assembly.
- Field assembled.

Specification Tips

- **For 120° applications.**
 - Not for stand alone applications
 - Must be used with additional kits.
- Requires Double Sided Starter Kit for benching application. Leg from Double Sided Starter Kit is repositioned to end-of-run.
- Requires three separately specified 120° Intuity worksurfaces:
 - 48”(1219mm)D kit require 24”(610mm)D worksurfaces
 - 60”(1524mm)D kit require 30”(762mm)D worksurfaces
- Access Hatch not available on 120° kits.
- Angled legs are required for Knife Edge worksurface option.
- Column leg provides intermediate shared support, additional knee clearance, and power and cable management.
- Rail features an inset channel for use with Intuity Screens, Belong Plus Screens and Active Components Center Screens.
- Below worksurface utility tray is optional for a non-powered application but recommended if below worksurface cable management is needed.
- Below worksurface utility tray is standard for 3-circuit, 4-circuit and hardwire options.
- 3-circuit, 4-circuit or hardwire power options are standard with below worksurface power access location.
- In 3- and 4-circuit power applications the Power Distribution Assemblies (PDA) will accept a maximum of twelve separately specified triplex receptacles; two per each side of the 120° Double Sided Starter Kit.
- Hardwire power option (-C) includes six junction boxes; conduit is field supplied.
- Separately specify electrical components for in and out power path.
- Do not mix 3-circuit with 4-circuit components. Do not mix 2+2 and 3+1 components. Components have unique polarity key and color coding (3-circuit=black, 2+2=blue and 3+1=green).

To Order, Specify:

1) Product number, including:

1 Leg Kit:

- W** Shared Straight Leg and Straight Leg
- Y** Shared Angled Leg and Angled Leg
- X** Column Leg and Straight Leg (add **\$358.13** list)
- Z** Column Leg and Angled Leg (add **\$358.13** list)

2 Power Type:

- N** Non-Powered
- 3** 3-Circuit, see chart for upcharge
- 2** 4-Circuit, 2+2, see chart for upcharge
- 4** 4-Circuit, 3+1, see chart for upcharge
- C** Hardwire, see chart for upcharge

2) Leg color*.

3) Accent plate color*.

4) Universal rail/utility tray/120° three-way cap color*.

***Note:** Upcharge for mixed grade trim surfaces; refer to the electronic design and specification tools for pricing.

2 Power Type

Width	3-Circuit	4-Circuit, 2+2	4-Circuit, 3+1	Hardwire
42"	\$689.71	\$689.71	\$689.71	\$1528.02
48"	707.63	707.63	707.63	1660.25
54"	725.55	725.55	725.55	1592.48

Depth	Width	Number	①	②	Trim	
					A	B
No Utility Tray - Non-Powered						
48”(1219mm)	42”(1067mm)	ZBCZ-4842-A	GHP	NNC	\$ 4733.47	\$ 4763.92
	48”(1219mm)	ZBCZ-4848-A	GHP	NNC	4853.99	4884.44
	54”(1372mm)	ZBCZ-4854-A	GHP	NNC	4974.51	5004.96
60”(1524mm)	42”(1067mm)	ZBCZ-6042-A	GHP	NNC	\$5560.03	\$5590.48
	48”(1219mm)	ZBCZ-6048-A	GHP	NNC	5680.55	5711.00
	54”(1372mm)	ZBCZ-6054-A	GHP	NNC	5801.07	5831.52
Utility Tray						
48”(1219mm)	42”(1067mm)	ZBCZ-4842-A	GHP	TC	\$ 5112.96	\$ 5143.41
	48”(1219mm)	ZBCZ-4848-A	GHP	TC	5287.19	5317.64
	54”(1372mm)	ZBCZ-4854-A	GHP	TC	5461.42	5491.87
60”(1524mm)	42”(1067mm)	ZBCZ-6042-A	GHP	TC	\$5939.52	\$5969.97
	48”(1219mm)	ZBCZ-6048-A	GHP	TC	6113.75	6144.20
	54”(1372mm)	ZBCZ-6054-A	GHP	TC	6287.98	6318.43

Leg Kits

Bench End Leg Kit

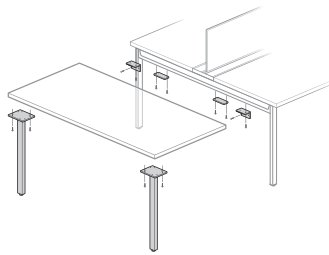

ZBE2-0000-PNFG

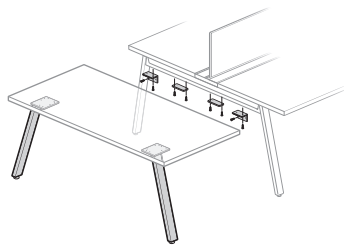

ZBA2-0000-PNFG
Class IN

Features

- Includes two fixed-height steel legs, brackets, and attachment hardware.
- Legs are 28" (711mm) to bottom of worksurface with glides fully recessed.
- Glides provide 0.5" (13mm) leveling adjustment.
- Field assembled.

Specification Tip

- Legs allow a bench end surface to be attached at the end of a double sided bench run.

To Order, Specify:

- 1) Product number.
- 2) Trim color.

Depth	Number	Trim	
		A	B
Straight Leg	ZBE2-0000-PNFG	\$720.46	\$741.36
Angled Leg	ZBA2-0000-PNFG	720.46	741.36

Return Leg Kit

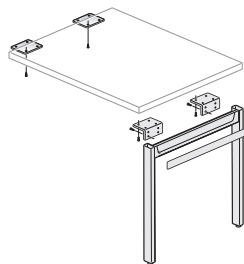

ZBI2-0030-HNFG

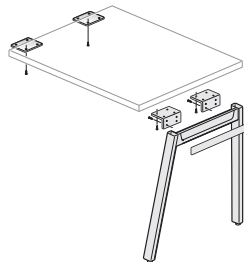

ZBA2-0024-HRFG
Class IN

Features

- Includes one fixed-height leg assembly, brackets, and attachment hardware.
- Leg is 28" (711mm) to bottom of worksurface with glides fully recessed.
- Glides provide 0.5" (13mm) leveling adjustment.
- Field assembled.

Specification Tips

- Allows a return worksurface to be attached to the front edge of a rectangular worksurface to create a return.
- Cannot be used in freestanding applications.

To Order, Specify:

- 1) Product number.
- 2) Leg color*.
- 3) Accent plate color*.

***Note:** Upcharge for mixed grade trim surfaces; refer to the electronic design and specification tools for pricing.

Depth	Orientation	Number	Trim	
			A	B
Straight Leg				
24" (610mm)	Non-Handed	ZBI2-0024-HNFG	\$ 519.40	\$557.73
30" (762mm)	Non-Handed	ZBI2-0030-HNFG	589.07	627.40
Angled Leg				
24" (610mm)	Left-Hand	ZBA2-0024-HLFG	\$ 519.40	\$557.73
	Right-Hand	ZBA2-0024-HRFG	519.40	557.73
30" (762mm)	Left-Hand	ZBA2-0030-HLFG	\$589.07	\$627.40
	Right-Hand	ZBA2-0030-HRFG	589.07	627.40

Worksurfaces

Rectangular Worksurface — No Access Hatch

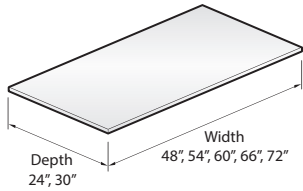

WBRA-SC
Class IN

Features

- Includes 1.18" (30mm) thick high pressure laminate (HPL) or wood worksurface and attachment hardware.
- Available with edgeband or knife edge.
 - Edgeband worksurface has 3mm edgeband on user edge, 1mm edgeband on sides and back.
 - Knife edge worksurface has knife edge on user edge, 1mm edgeband on sides and back. Knife edge profile receives a clear coat finish.

Specification Tips

- For **in-line** benching applications only; not for return benching applications.
- For use with starter kit or add-on kit with no access hatches, option (-C).
- When attached to starter or add-on kit, worksurface has a 1" (25mm) gap between the back edge of the surface and the rail.
- In double sided applications, there is a total of 3.64" (92mm) between the back edges of the surfaces (includes depth of rail and gap between rail and worksurfaces).
- May not be supported by attached lower storage.
- Angled Legs are required for Knife Edge worksurface option.
- X Series 23" (584mm)D, box/file, mobile pedestal will not fully nest beneath a 24" (610mm)D, worksurface with a Utility Tray.
- Only for use with Active Components attached storage. See Active Components Price List.
- May be used with Belong Work Tools and Accessories, Adjustable Keyboard Pads and Monitor Arms.

To Order, Specify:

1) Product number, including:

1 Top Option:

L HPL

W Wood

2 Edge Option:

HPL:

J Edgeband

F Knife

Wood:

K Edgeband

U Knife

2) HPL or Wood finish color.

3) Edge trim color (HPL only).

Depth	Width	Number 1 2	HPL Edgeband (J)			HPL Knife Edge (F)			Wood Edgeband (K)		Wood Knife Edge (U)	
			A	B	E	A	B	E	A	B	A	B
24" (610mm)	48" (1219mm)	WBRA-2448- SC	\$296.98	\$ 317.68	\$ 381.00	\$ 475.24	\$495.94	\$ 559.26	\$ 869.25	\$ 979.98	\$1088.65	\$1228.96
	54" (1372mm)	WBRA-2454- SC	323.26	345.94	422.40	510.58	533.26	609.72	921.63	1041.60	1152.07	1290.58
	60" (1524mm)	WBRA-2460- SC	349.54	374.20	463.80	545.92	570.58	660.18	974.01	1103.22	1215.49	1352.20
	66" (1676mm)	WBRA-2466- SC	375.82	402.46	505.20	581.26	607.90	710.64	1026.39	1164.84	1278.91	1413.82
	72" (1829mm)	WBRA-2472- SC	402.10	430.72	546.60	616.60	645.22	761.10	1078.77	1226.46	1342.33	1475.44
30" (762mm)	48" (1219mm)	WBRA-3048- SC	\$353.80	\$379.12	\$470.64	\$532.06	\$ 557.38	\$648.90	\$ 982.95	\$ 1113.78	\$1202.35	\$1362.76
	54" (1372mm)	WBRA-3054- SC	380.08	407.38	512.04	567.40	594.70	699.36	1035.33	1175.40	1265.77	1424.38
	60" (1524mm)	WBRA-3060- SC	406.36	435.64	553.44	602.74	632.02	749.82	1087.71	1237.02	1329.19	1486.00
	66" (1676mm)	WBRA-3066- SC	432.64	463.90	594.84	638.08	669.34	800.28	1140.09	1298.64	1392.61	1547.62
	72" (1829mm)	WBRA-3072- SC	458.92	492.16	636.24	673.42	706.66	850.74	1192.47	1360.26	1456.03	1609.24

Worksurfaces

Rectangular Worksurface – For Use with Access Hatches

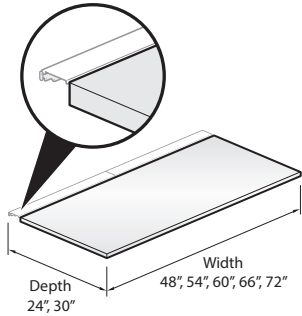

WBRA-SS
Class IN

Features

- Includes 1.18\"(30mm) thick high pressure laminate (HPL) or wood worksurface and attachment hardware.
- Available with edgeband or knife edge.
 - Edgeband worksurface has 3mm edgeband on user edge, 1mm edgeband on sides and back.
 - Knife edge worksurface has knife edge on user edge, 1mm edgeband on sides and back. Knife edge profile receives a clear coat finish.
- For use on Starter Kits and Add-On Kits specified with access hatches.

Specification Tips

- For **in-line** benching applications only; not for return benching applications.
- For use with Starter Kit or Add-On Kit with access hatches, option (-S).
- Access hatches at the back of the worksurface are factory-installed with Starter Kit or Add-On Kit.
- 24\"(610mm)D worksurface provides 20\"(508mm) of depth from the front edge to the access hatches.
- 30\"(762mm)D worksurface provides 26\"(660mm) of depth from the front edge to the access hatches.
- Gap between back edge of worksurface and access hatches is 1\"(25mm).
- May not be supported by attached lower storage.
- Angled Legs are required for Knife Edge worksurface option.
- X series 23\"(584mm)D, box/file, mobile pedestal will not fully nest beneath a 24\"(610mm)D worksurface with a Utility Tray.
- Only for use with Active Components attached storage. See Active Components Price List.
- May be used with most Belong Work Tools and Accessories, Adjustable Keyboard Pads and Monitor Arms (with special clamp); refer to the appropriate price list pages for details.

To Order, Specify:

1) Product number, including:

1 Top Option:

- L** HPL
- W** Wood

2 Edge Option:

- HPL:
- J** Edgeband
 - F** Knife
- Wood:
- K** Edgeband
 - U** Knife

2) HPL or Wood finish color.
3) Edge trim color (HPL only).

Actual Depth	Nominal Depth	Width	Number ①②	HPL Edgeband (J)			HPL Knife Edge (F)			Wood Edgeband (K)		Wood Knife Edge (U)	
				A	B	E	A	B	E	A	B	A	B
20\"(508mm)	24\"(610mm)	48\"(1219mm)	WBRA-2448-SS	\$296.98	\$317.68	\$381.00	\$475.24	\$495.94	\$559.26	\$869.25	\$979.98	\$1088.65	\$1228.96
		54\"(1372mm)	WBRA-2454-SS	323.26	345.94	422.40	510.58	533.26	609.72	921.63	1041.60	1152.07	1290.58
		60\"(1524mm)	WBRA-2460-SS	349.54	374.20	463.80	545.92	570.58	660.18	974.01	1103.22	1215.49	1352.20
		66\"(1676mm)	WBRA-2466-SS	375.82	402.46	505.20	581.26	607.90	710.64	1026.39	1164.84	1278.91	1413.82
		72\"(1829mm)	WBRA-2472-SS	402.10	430.72	546.60	616.60	645.22	761.10	1078.77	1226.46	1342.33	1475.44
26\"(660mm)	30\"(762mm)	48\"(1219mm)	WBRA-3048-SS	\$353.80	\$379.12	\$470.64	\$532.06	\$557.38	\$648.90	\$982.95	\$1113.78	\$1202.35	\$1362.76
		54\"(1372mm)	WBRA-3054-SS	380.08	407.38	512.04	567.40	594.70	699.36	1035.33	1175.40	1265.77	1424.38
		60\"(1524mm)	WBRA-3060-SS	406.36	435.64	553.44	602.74	632.02	749.82	1087.71	1237.02	1329.19	1486.00
		66\"(1676mm)	WBRA-3066-SS	432.64	463.90	594.84	638.08	669.34	800.28	1140.09	1298.64	1392.61	1547.62
		72\"(1829mm)	WBRA-3072-SS	458.92	492.16	636.24	673.42	706.66	850.74	1192.47	1360.26	1456.03	1609.24

Worksurfaces

Rectangular Bench End Worksurface

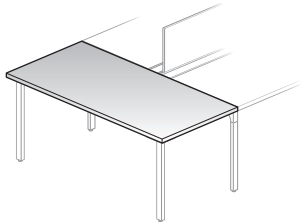

WBDA-SC
Class IN

Features

- Includes 1.18"(30mm) thick high pressure laminate (HPL) or wood worksurface.
- Available with edgeband or knife edge.
 - Edgeband worksurface has 3mm edgeband on user edge and sides, 1mm edgeband on back.
 - Knife edge worksurface has knife edge on user edge and sides, 1mm edgeband on back. Knife edge profile receives a clear coat finish.
- Attaches at the end of a double-sided bench using bench end legs, specified separately.

Specification Tips

- 51"(1295mm)D worksurface attaches to 48"(1219mm)D double sided bench.
- 63"(1600mm)D worksurface attaches to 60"(1524mm)D double sided bench.
- Worksurface is not available with access hatches and is non-powered.
- Worksurface is not available with a rail and does not accept an Intuity screen.

To Order, Specify:

- Product number, including:

1 Top Option:

- L** HPL
- W** Wood

2 Edge Option:

- HPL:
- J** Edgeband
 - F** Knife
- Wood:
- K** Edgeband
 - U** Knife

- HPL or Wood finish color.
- Edge trim color (HPL only).

Depth	Width	Number ①②	HPL Edgeband (J)		HPL Knife Edge (F)		Wood Edgeband (K)		Wood Knife Edge (U)	
			A	B	A	B	A	B	A	B
51"(1295mm)	24"(610mm)	WBDA-5124-SC	\$ 319.13	\$ 339.83	\$ 497.39	\$ 518.09	\$ 891.40	\$ 1002.13	\$ 1110.80	\$ 1251.11
	30"(762mm)	WBDA-5130-SC	345.41	368.09	523.67	546.35	943.78	1063.75	1163.18	1312.73
63"(1600mm)	24"(610mm)	WBDA-6324-SC	\$ 392.57	\$ 419.87	\$ 570.83	\$ 598.13	\$ 1118.80	\$ 1269.73	\$ 1338.20	\$ 1518.71
	30"(762mm)	WBDA-6330-SC	418.85	448.13	597.11	626.39	1171.18	1331.35	1390.58	1580.33

Rectangular Return Worksurface

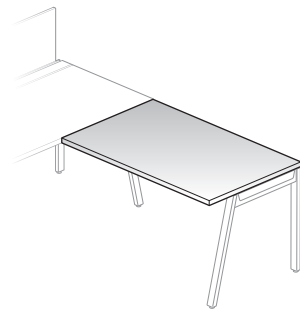

WBRB-SC
Class IN

Features

- Includes 1.18"(30mm) thick high pressure laminate (HPL) or wood rectangular worksurface.
- Available with edgeband or knife edge.
 - Edgeband worksurface has 3mm edgeband on user edge, 1mm edgeband on sides and back.
 - Knife edge worksurface has knife edge on user edge, 1mm edgeband on sides and back. Knife edge profile receives a clear coat finish.
- Attaches along the front of a benching surface using return leg kit, specified separately.

Specification Tips

- Worksurface is not available with access hatches and is non-powered.
- Worksurface is not available with a rail and does not accept an Intuity screen.
- Specify surface depth to match return leg depth.
- Knife edge return has square edges on sides; when used with a knife edge benching surface, edge profile of return will not match front edge of benching surface. To avoid a gap in edge profiles, specify benching surface with edgeband.

To Order, Specify:

- Product number, including:

1 Top Option:

- L** HPL
- W** Wood

2 Edge Option:

- HPL:
- J** Edgeband
 - F** Knife
- Wood:
- K** Edgeband
 - U** Knife

- HPL or Wood finish color.
- Edge trim color (HPL only).

Depth	Width	Number ①②	HPL Edgeband (J)		HPL Knife Edge (F)		Wood Edgeband (K)		Wood Knife Edge (U)	
			A	B	A	B	A	B	A	B
24"(610mm)	48"(1219mm)	WBRB-2448-SC	\$ 228.94	\$ 411.74	\$ 446.52	\$ 629.32	\$ 498.51	\$ 550.22	\$ 717.91	\$ 769.62
	54"(1372mm)	WBRB-2454-SC	252.93	437.64	474.20	658.91	524.33	580.67	756.66	813.00
	60"(1524mm)	WBRB-2460-SC	276.92	463.54	501.88	688.50	550.15	611.12	795.41	856.38
30"(762mm)	48"(1219mm)	WBRB-3048-SC	\$ 260.31	\$ 445.62	\$ 477.89	\$ 663.20	\$ 585.31	\$ 652.45	\$ 804.71	\$ 871.85
	54"(1372mm)	WBRB-3054-SC	284.30	471.52	505.57	692.79	611.13	682.90	843.46	915.23
	60"(1524mm)	WBRB-3060-SC	308.29	497.42	533.25	722.38	636.95	713.35	882.21	958.61

Worksurfaces

Corner, 120° Wrap-Around

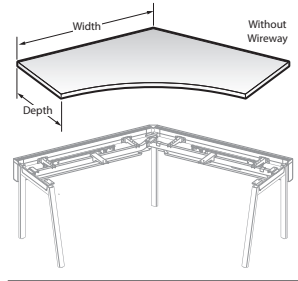

Wireway Options:

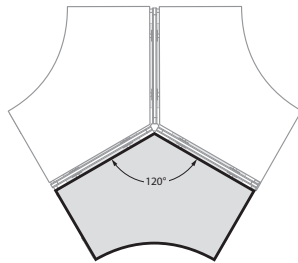
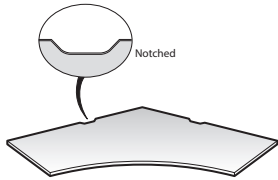

WBCZ-S
Class IN

Features

- Includes 1.18" (30mm) thick high pressure laminate (HPL) or wood work surface and tie plate.
- Available with edgeband or knife edge.
- Edgeband work surface has 3mm edgeband on the user edge, 1mm edgeband on sides and back.
- Knife edge work surface has knife edge on user edge, 1mm edgeband and on sides and back. Knife edge profile receives a clear coat finish.
- Optional wireway along back edges of work surface is color-matched to solid side/back edge trim. When wood veneer, wood grain or patterned HPL is specified, wireway will be charcoal. Refer to Specification Guide for wireway details.
- Depths and widths shown in nominal dimensions.

Specification Tips

- For 120° single or three-pack applications; not for return benching applications.
- When attached to a starter or add-on kit, work surface has a 1" (25mm) gap between the back edges of the surface and the rail.
- In double sided applications, there is a total of 3.64" (92mm) between the back edges of the surfaces (includes depth of rail and gap between rail and work surfaces).
- May not be supported by attached lower storage.
- Angled legs are required for Knife Edge work surface option.
- X Series 23" (584mm) D, box/file, mobile pedestal will not fully nest beneath a 24" (610mm) D work surface with Utility Tray.
- Only for use with Active Components attached storage. See Active Components Price List.
- May be used with Belong Work Tools, Accessories, Adjustable Keyboard Pads and Monitor Arms.

To Order, Specify:

1) Product number, including:

1 Top Option:

- L** HPL
- W** Wood

2 Edge Option:

HPL:

- J** Edgeband
- F** Knife

Wood:

- K** Edgeband
- U** Knife

3 Wireway Option:

- A** Notched
- B** Without

2) HPL or Wood finish color.

3) Edge trim color (HPL only).

Left/Right Depth	Width	Number	① ② ③	HPL Edgeband (J)		HPL Knife Edge (F)		Wood Edgeband (K)		Wood Knife Edge (U)	
				A	B	A	B	A	B	A	B
24" (610mm)	42" (1067mm)	WBCZ-4242-	S N44	\$ 767.98	\$ 783.07	\$ 1123.89	\$ 1138.98	\$ 1925.58	\$ 2204.93	\$ 2804.30	\$ 3083.65
	48" (1219mm)	WBCZ-4848-	S N44	850.54	869.26	1230.90	1249.62	2112.03	2424.47	3097.25	3409.69
	54" (1372mm)	WBCZ-5454-	S N44	1040.10	1062.45	1444.91	1467.26	2405.48	2751.01	3497.20	3842.73
30" (762mm)	42" (1067mm)	WBCZ-4242-	S N55	\$ 790.17	\$ 807.04	\$ 1172.70	\$ 1189.57	\$ 2103.10	\$ 2414.06	\$ 2981.82	\$ 3292.78
	48" (1219mm)	WBCZ-4848-	S N55	872.73	893.23	1279.71	1300.21	2289.55	2633.60	3274.77	3618.82
	54" (1372mm)	WBCZ-5454-	S N55	1062.29	1086.42	1493.72	1517.85	N/A	N/A	N/A	N/A

Accessories

Tie Plate

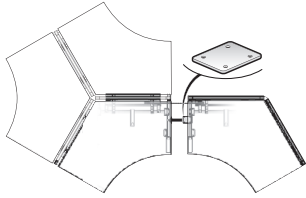

ZBBP-0000-PN
Class IN

Features

- Includes painted tie plate and attachment hardware.
- Tie plate is used to connect a single sided kit to a double sided kit.
- Required for pass-through power.
- Standard in Black.

To Order, Specify:

- 1) Product number.
(No finish specification required.)

Number	Price
ZBBP-0000-PN	\$30.62

Double-Sided Utility Tray End Covers

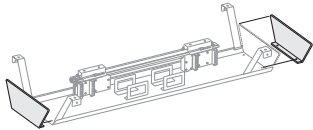

EUEC-0000
Class IN

Features

- Includes two covers and hardware.
- For use on double sided kits.
- Standard in Black.

To Order, Specify:

- 1) Product number.
(No finish specification required.)

Number	Price
EUEC-0000	\$116.74

120° Infeed Cover

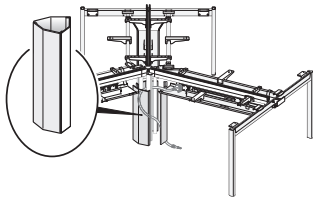

EBEC-0000-F
Class IN

Features

- Includes 3-piece cover and attachment hardware.
- Optional cover is used to conceal infeed for electrical application and/or cover three center post legs.
- Only for use with Three Pack 120° workstations.

To Order, Specify:

- 1) Product number.
- 2) Trim color.

Number	Trim	
	A	B
EBEC-0000-F	\$231.67	\$249.45

Access Hatch Gap Filler

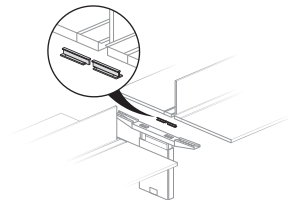

ZBRA-0000-D
Class IN

Features

- Includes painted aluminum extrusion(s) and attachment hardware.
- Fits between a starter and add-on kit, or between two add-on kits, to fill the gap between the access hatches.
- Single sided includes one filler piece; double sided includes two filler pieces.
- Single sided filler piece and double side filler piece are specific to the application and cannot be interchanged.

To Order, Specify:

- 1) Product number.
- 2) Trim color.

Number	Trim	
	A	B
Single Sided		
ZBRA-0000-S	\$83.09	\$102.29
Double Sided		
ZBRA-0000-D	\$115.41	\$134.61

Electrical Components

Infeed Harness

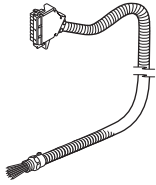

EUEH-0087-3
EUEH-0087-2
EUEH-0087-4
Class YA



Features

- Includes electrical harness in galvanized metal conduit.
- Conduit for 3-Circuit includes eight 12-gauge wires for up to three 20 amp circuits of power.
- Conduit for 4-Circuit includes six 12-gauge and two 10-gauge wires for up to four 20 amp circuits of power.
- Can be used to route power from floor to power distribution assembly.
- For use with components equipped with power.
- Attaches at any receptacle site or right-hand jumper location.

Specification Tips

- **Not for use with power sources other than 120 volt 60 hertz.**
- A vertical base feed cover is a separately specified option.
- Exposed split tubing may be field supplied separately to cover exposed galvanized metal conduit.
- Do not mix 3-circuit with 4-circuit components. Do not mix 2+2 and 3+1 components. Components have unique polarity key and color coding (3-circuit = black; 2+2 = blue; 3+1 = green).
- Application may require approval of local authority having jurisdiction (AHJ); ensure compliance before placing orders and installation.

To Order, Specify:

- 1) Product number.
(No finish specification required.)

Description	Feed Length	Number	Price
3-Circuit			
	87"(2210mm)	EUEH-0087-3	\$306.75
	180"(4572mm)	EUEH-00F0-3	457.66
	300"(7620mm)	EUEH-00W0-3	750.59
4-Circuit, 2+2			
	87"(2210mm)	EUEH-0087-2	\$ 313.70
	180"(4572mm)	EUEH-00F0-2	464.61
	300"(7620mm)	EUEH-00W0-2	757.54
4-Circuit, 3+1			
	87"(2210mm)	EUEH-0087-4	\$ 313.70
	180"(4572mm)	EUEH-00F0-4	464.61
	300"(7620mm)	EUEH-00W0-4	757.54

Base Feed Module — Hardwire Connection

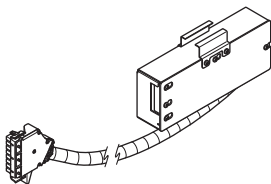

EUEB-0000-3HY
EUEB-0000-2HY
EUEB-0000-4HY
Class SP



Features

- Includes one junction box with modular connector, flexible steel conduit and three 0.5"(13mm) knockouts.
- Conduit for 3-Circuit includes eight 12-gauge wires for up to three 20 amp circuits of power.
- Conduit for 4-Circuit includes six 12-gauge and two 10-gauge wires for up to four 20 amp circuits of power.
- For use with components equipped with power.
- Attaches at any receptacle site or right-hand jumper location.
- For floor, column or wall hardwire connections.
- Conforms to New York City electrical code.

Specification Tips

- **Not for use with power sources other than 120 volt 60 hertz.**
- A vertical base feed cover is a separately specified option.
- For installation on components 42"(1067mm) or larger.
- Conduit and fittings for connection between building and junction box are supplied by local electricians.
- Do not mix 3-circuit with 4-circuit components. Do not mix 2+2 and 3+1 components. Components have unique polarity key and color coding (3-circuit = black; 2+2 = blue; 3+1 = green).
- Application may require approval of local authority having jurisdiction (AHJ); ensure compliance before placing orders and installation.

To Order, Specify:

- 1) Product number.
(No finish specification required.)

Description	Number	Price
3-Circuit	EUEB-0000-3HY	\$490.14
4-Circuit, 2+2	EUEB-0000-2HY	\$ 572.14
4-Circuit, 3+1	EUEB-0000-4HY	\$ 572.14

Electrical Components

Single Circuit Base Feed – Receptacle Connection with Power Cord — 3-Circuit and 4-Circuit

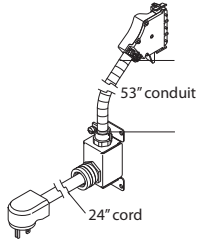

4TEB-20
Class TA



Features

- Includes one base feed, 24"(610mm) cord, junction box, 53"(1346mm) flexible conduit and 20 amp plug (NEMA 5-20P).
- For use with product equipped with 3-circuit or 4-circuit power components.
- Requires a 20 amp, 125 volt building receptacle (NEMA 5-20R) for plug-in (not included).
- Provides power to circuit #1 only.
- Attaches at any flex/jumper locations on a Power Distribution Assembly (PDA).
- Standard in charcoal trim color only.

Specification Tips

- **Not for use with isolated ground receptacles.**
- **Not for use with power sources other than 120 volt 60 hertz.**
- **Not for use in Canada due to electrical code restrictions.**
- Junction box must be secured to furniture or architectural support.
- Do not mix 3-circuit with 4-circuit components. Do not mix 2+2 and 3+1 components. Components have unique polarity key and color coding (3-circuit=black, 2+2=blue and 3+1=green).
- Application may require approval of local authority having jurisdiction (AHJ); ensure compliance before placing orders and installation.

To Order, Specify:

- 1) Product number.
(No finish specification required.)

Description	Feed Length	Number	Price
3-Circuit	24"(610mm)	4TEB-20	\$485.01
4-Circuit, 2+2		4TEB-20-2	485.01
4-Circuit, 3+1		4TEB-20-4	485.01

Single Circuit Base Feed – Receptacle Connection — 3-Circuit and 4-Circuit

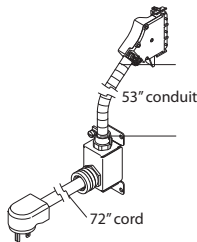

4TEB-15
Class TA



Features

- Includes one base feed, 72"(1829mm) cord, junction box, 53"(1346mm) flexible conduit and 15 amp plug (NEMA 5-15P).
- For use with product equipped with 3-circuit or 4-circuit power components.
- Requires a 15 amp, 125 volt building receptacle (NEMA 5-15R) for plug-in (not included).
- Attaches at any flex/jumper locations on a Power Distribution Assembly (PDA).
- Provides power to circuit #1 only.
- Standard in charcoal trim color only.

Specification Tips

- **Not for use in USA due to electrical code restrictions.**
- **Not for use with isolated ground receptacles.**
- Not for use with power sources other than 120 volt 60 hertz.
- Junction box must be secured to furniture or architectural support.
- Do not mix 3-circuit with 4-circuit components. Do not mix 2+2 and 3+1 components. Components have unique polarity key and color coding (3-circuit=black, 2+2=blue and 3+1=green).
- Application may require approval of local authority having jurisdiction (AHJ); ensure compliance before placing orders and installation.

To Order, Specify:

- 1) Product number.
(No finish specification required.)

Description	Feed Length	Number	Price
3-Circuit	72"(1829mm) (Canada only)	4TEB-15	\$485.01
4-Circuit, 2+2		4TEB-15-2	485.01
4-Circuit, 3+1		4TEB-15-4	485.01

Electrical Components

Base Feed Module Hardwire Connection

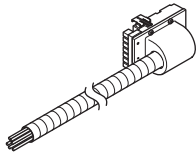

4TEB-1
Class TA



Features

- Includes one base feed with 6'(1829mm) long, black 0.5"(13mm) flexible metal conduit with eight 12-gauge wires for up to three 20-amp circuits of power.
- For floor, column, or wall hardwire connections.
- Base feed module can be field modified to accommodate left or right conditions.
- Attaches to any of the receptacle sites.
- Standard in charcoal trim color only.

Specification Tips

- **Not for use with power sources other than 120 volt 60 hertz.**
- Do not mix 3-circuit with 4-circuit components. Do not mix 2+2 and 3+1 components. Components have unique polarity key and color coding (3-circuit=black, 2+2=blue and 3+1=green).
- Application may require approval of local authority having jurisdiction (AHJ); ensure compliance before placing orders and installation.

To Order, Specify:

- 1) Product number.
(No finish specification required.)

	Number	Price
	4TEB-1	\$512.42

Internal Power Base™ AI Base Feed

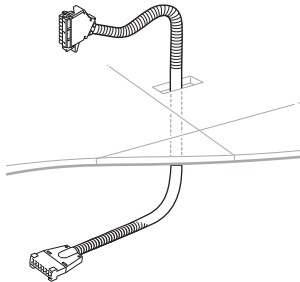

EUEJ-0064-3WF
EUEJ-0064-2WF
EUEJ-0064-4WF
Class SP



Features

- Includes connector assembly which consists of one Power Base connector head, galvanized 0.5"(13mm) flexible metal conduit, one Power Base AI connector head and a two port splitter.
- Conduit for 3-Circuit includes eight 12-gauge wires for up to three 20 amp circuits of power.
- Conduit for 4-Circuit includes six 12-gauge and two 10-gauge wires for up to four 20 amp circuits of power.
- For use with components equipped with power.
- Attaches at any receptacle site or right-hand jumper location and to a Power Base AI underfloor power system.

Specification Tips

- **Not for use with power sources other than 120 volt 60 hertz.**
- A vertical base feed cover is a separately specified option when used with Intuity.
- Exposed split tubing may be field supplied separately to cover exposed galvanized metal conduit.
- Excess length can be coiled under floor.
- Do not mix 3-circuit with 4-circuit components. Do not mix 2+2 and 3+1 components. Components have unique polarity key and color coding (3-circuit = black; 2+2 = blue; 3+1 = green).
- Application may require approval of local authority having jurisdiction (AHJ); ensure compliance before placing orders and installation.

To Order, Specify:

- 1) Product number.
(No finish specification required.)

Description	Feed Length	Number	Price
3-Circuit			
	64"(1626mm)	EUEJ-0064-3WF	\$346.75
	144"(3658mm)	EUEJ-0144-3WF	454.57
	300"(7620mm)	EUEJ-0300-3WF	988.29
4-Circuit, 2+2			
	64"(1626mm)	EUEJ-0064-2WF	\$353.70
	144"(3658mm)	EUEJ-0144-2WF	461.52
	300"(7620mm)	EUEJ-0300-2WF	995.24
4-Circuit, 3+1			
	64"(1626mm)	EUEJ-0064-4WF	\$353.70
	144"(3658mm)	EUEJ-0144-4WF	461.52
	300"(7620mm)	EUEJ-0300-4WF	995.24

Electrical Components

Jumper

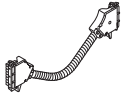

EUEJ-0024-3
EUEJ-0024-2
EUEJ-0024-4
Class YA



Features

- Includes flexible metal power jumper with safety latches.
- For use with power components.
- Jumpers cannot be coupled together.
- Field installed.

Specification Tips:

- **Jumpers are used to connect between Power Distribution Assemblies mounted in Utility Trays in an in-line benching application.**
- One 24"(610mm) jumper is included with Add-On Kit.
- For use with Intuity product reconfigurations.
- Do not mix 3-circuit with 4-circuit components. Do not mix 2+2 and 3+1 components. Components have unique polarity key and color coding (3-circuit = black; 2+2 = blue; 3+1 = green).
- Application may require approval of local authority having jurisdiction (AHJ); ensure compliance before placing orders and installation.

To Order, Specify:

- 1) Product number.
(No finish specification required.)

Description	Actual Length	Number	Price
3-Circuit	24"(610mm)	EUEJ-0024-3	\$186.31
4-Circuit, 2+2	24"(610mm)	EUEJ-0024-2	\$198.45
4-Circuit, 3+1	24"(610mm)	EUEJ-0024-4	\$198.45

Utility Tray Power Retrofit Kit

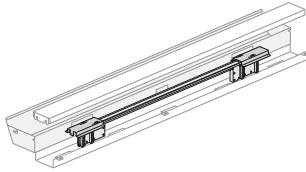

EUEK-3S
EUEK-2S
EUEK-4S
Class YA



Features

- Includes Power Distribution Assembly (PDA).
- Field installed.

Specification Tips:

- Used to convert non-powered Utility Tray to powered.
- **Separately Specify:**
 - Receptacles
 - Jumpers
 - Power Infeeds
 - Utility Tray End Covers
- When adding retrofit kit, order PDA mounting brackets, service part #2305-8603, separately.
- Do not mix 3-circuit with 4-circuit components. Do not mix 2+2 and 3+1 components. Components have unique polarity key and color coding (3-circuit = black; 2+2 = blue; 3+1 = green).

To Order, Specify:

- 1) Product number.
(No finish specification required.)

Description	Panel Width	PDA Length	Number	Price
3-Circuit				
	42"(1067mm)	19"(483mm)	EUEK-0042-3S	\$ 124.28
	48"(1219mm)	25"(635mm)	EUEK-0048-3S	139.28
	54"(1372mm)	31"(787mm)	EUEK-0054-3S	154.28
	60"(1524mm)	37"(940mm)	EUEK-0060-3S	169.28
	66"(1676mm)	43"(1092mm)	EUEK-0066-3S	184.28
	72"(1829mm)	49"(1245mm)	EUEK-0072-3S	199.28
4-Circuit, 2+2				
	42"(1067mm)	19"(483mm)	EUEK-0042-2S	\$ 144.28
	48"(1219mm)	25"(635mm)	EUEK-0048-2S	159.28
	54"(1372mm)	31"(787mm)	EUEK-0054-2S	174.28
	60"(1524mm)	37"(940mm)	EUEK-0060-2S	189.28
	66"(1676mm)	43"(1092mm)	EUEK-0066-2S	204.28
	72"(1829mm)	49"(1245mm)	EUEK-0072-2S	219.28
4-Circuit, 3+1				
	42"(1067mm)	19"(483mm)	EUEK-0042-4S	\$ 144.28
	48"(1219mm)	25"(635mm)	EUEK-0048-4S	159.28
	54"(1372mm)	31"(787mm)	EUEK-0054-4S	174.28
	60"(1524mm)	37"(940mm)	EUEK-0060-4S	189.28
	66"(1676mm)	43"(1092mm)	EUEK-0066-4S	204.28
	72"(1829mm)	49"(1245mm)	EUEK-0072-4S	219.28

Electrical Components

Top Feed

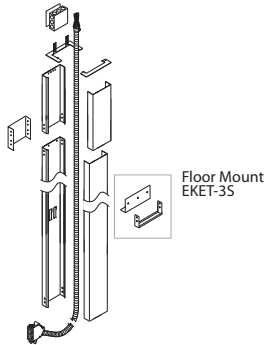

EKET-C000-3S
EKET-C000-2S
EKET-C000-4S
Class YA



Features

- Includes one 180"(4572mm) electrical harness in metal conduit, electrical box, ceiling bezel plate, pole and hardware.
- Conduit for 3-Circuit includes eight 12-gauge wires for up to three 20 amp circuits of power.
- Conduit for 4-Circuit includes six 12-gauge and two 10-gauge wires for up to four 20 amp circuits of power.
- For connection to the electrical source located in space above a drop ceiling.
- Removable cover on poles provides access to pathway.
- Top feed pole dimensions: 2.5"(64mm) x 8"(203mm).
- Harness attaches at any receptacle site or right-hand jumper location.

Specification Tips

- **Not for use with power sources other than 120 volt 60 hertz.**
- Electrical harness length is 180"(4572mm) regardless of pole length.
- Top Feed may interfere with Tool Rail or Screen applications.
- Floor mount Top Feed mounts to floor, attaches to desking worksurface at any side and ceiling.
- Floor attachment hardware is field supplied.
- Do not mix 3-circuit with 4-circuit components. Do not mix 2+2 and 3+1 components. Components have unique polarity key and color coding (3-circuit = black; 2+2 = blue; 3+1 = green).
- Application may require approval of local authority having jurisdiction (AHJ); ensure compliance before placing orders and installation.

To Order, Specify:

- 1) Product number.
- 2) Trim color.

Description	Ceiling Height	Pole Length	Number	Trim	
				A	B
Floor Mount Height					
3-Circuit	10'(3048mm)	138"(3505mm)	EKET-C000-3S	\$1394.09	\$1480.91
	12'(3658mm)	150"(3810mm)	EKET-E400-3S	1423.03	1524.33
4-Circuit, 2+2	10'(3048mm)	138"(3505mm)	EKET-C000-2S	\$1564.09	\$1650.91
	12'(3658mm)	150"(3810mm)	EKET-E400-2S	1593.03	1694.33
4-Circuit, 3+1	10'(3048mm)	138"(3505mm)	EKET-C000-4S	\$1564.09	\$1650.91
	12'(3658mm)	150"(3810mm)	EKET-E400-4S	1593.03	1694.33

Electrical Components

Triplex Receptacle – 15 Amp

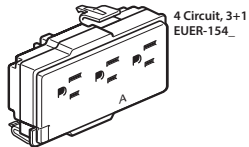
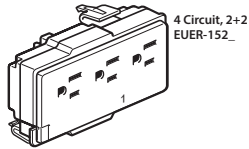
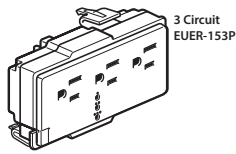
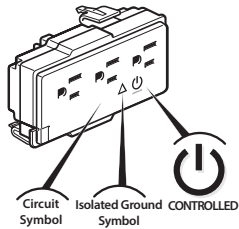

EUER-15
Class YA

Features

- Includes box of six receptacles, each receptacle has three 15 Amp outlets (NEMA 5-15R configuration).
- For use with panels equipped with power components.
- Receptacles are ground type specific.

Specification Tips

- Not for use with power sources other than 120 volt 60 hertz.
- For power access at any location within the panels with appropriate base raceway covers or technology pad.
- Isolated ground receptacle not for use with single circuit base feed module.
- Triplexes for 3-Circuit are field programmable.
- Triplexes for 4-Circuit have fixed circuit access and are not field programmable. Specify appropriate number of receptacles for each circuit.
- Do not mix 3-circuit with 4-circuit components. Do not mix 2+2 and 3+1 components. Components have unique polarity key and color coding (3-circuit=black, 2+2=blue and 3+1=green).
- **Controlled receptacles are marked with a permanent symbol and the word CONTROLLED to comply with various energy code requirements including ASHRAE 90.1 and California Building Code Title 24 part 6.**
- **Circuit assignment and receptacle placement should be coordinated with a local electrician. Local electrician is responsible for circuit loading and code compliance.**
- **Consult with local authority having jurisdiction (AHJ) for requirements regarding controlled receptacles before placing orders and installation.**

Circuit Symbol	Circuit 1	Circuit 2	Circuit 3	Circuit 4
3 Circuit	0	00	000	NA
4 Circuit 2+2	1	2	3	4
4 Circuit 3+1	A	B	C	D

To Order, Specify:

- 1) Product number.
 - 2) Trim color.
- | | |
|-------|------------------------------|
| TR-R | Beige |
| TR-AK | Chalk |
| TR-K | Charcoal |
| TR-J | Graphite |
| TR-G | Gray Tone |
| TR-NG | Orange* Isolated ground only |
| TR-TW | Plaster |
| TR-AA | Putty |
| TR-E | Smoke |

Description	Circuit Access	Receptacle Indicator	Ground Type	Receptacle without Controlled Symbol	Price	Receptacle with Controlled Symbol	Price
3-Circuit							
	Circuit 1-3	N/A	Common	EUER-153P-GSOS	\$202.24	EUER-153P-GCOS	\$284.54
	Circuit 1-3	N/A	Isolated	EUER-153P-ISOS	213.08	EUER-153P-ICOS	217.79
4-Circuit, 2+2							
	Circuit 1	1	Common	EUER-1521-GSOS	\$ 278.21	EUER-1521-GCOS	\$284.54
	Circuit 2	2		EUER-1522-GSOS	278.21	EUER-1522-GCOS	284.54
	Circuit 3	3		EUER-1523-GSOS	278.21	EUER-1523-GCOS	284.54
	Circuit 4	4		EUER-1524-GSOS	278.21	EUER-1524-GCOS	284.54
	Circuit 1	1	Isolated	EUER-1521-ISOS	\$289.05	EUER-1521-ICOS	\$295.66
	Circuit 2	2		EUER-1522-ISOS	289.05	EUER-1522-ICOS	295.66
	Circuit 3	3		EUER-1523-ISOS	289.05	EUER-1523-ICOS	295.66
	Circuit 4	4		EUER-1524-ISOS	289.05	EUER-1524-ICOS	295.66
4-Circuit, 3+1							
	Circuit 1	A	Common	EUER-1541-GSOS	\$ 278.21	EUER-1541-GCOS	\$284.54
	Circuit 2	B		EUER-1542-GSOS	278.21	EUER-1542-GCOS	284.54
	Circuit 3	C		EUER-1543-GSOS	278.21	EUER-1543-GCOS	284.54
	Circuit 4	D		EUER-1544-GSOS	278.21	EUER-1544-GCOS	284.54
	Circuit 1	A	Isolated	EUER-1541-ISOS	\$289.05	EUER-1541-ICOS	\$295.66
	Circuit 2	B		EUER-1542-ISOS	289.05	EUER-1542-ICOS	295.66
	Circuit 3	C		EUER-1543-ISOS	289.05	EUER-1543-ICOS	295.66
	Circuit 4	D		EUER-1544-ISOS	289.05	EUER-1544-ICOS	295.66

Electrical Components

Triplex Receptacle – 20 Amp

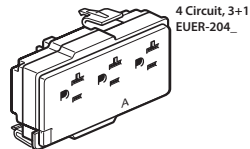
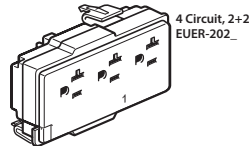
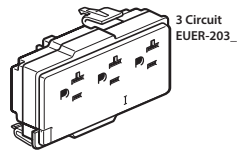
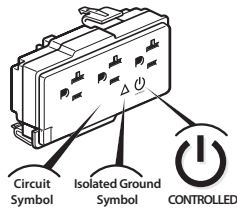

EUEP-20
Class YA

Features

- Includes box of six receptacles, each receptacle has three 20 Amp outlets (NEMA 5-20R configuration).
- For use with panels equipped with power components.
- **Receptacles are circuit and ground type specific.**

Specification Tips

- Not for use with power sources other than 120 volt 60 hertz.
- Receptacles have fixed circuit access and are not field programmable. Specify appropriate number of receptacles for each circuit.
- For power access at any location within the panels with appropriate base raceway covers or technology pad.
- Isolated ground receptacle not for use with single circuit base feed module.
- Do not mix 3-circuit with 4-circuit components. Do not mix 2+2 and 3+1 components. Components have unique polarity key and color coding (3-circuit=black, 2+2=blue and 3+1=green).
- **Controlled receptacles are marked with a permanent symbol and the word CONTROLLED to comply with various energy code requirements including ASHRAE 90.1 and California Building Code Title 24 part 6.**
- **Circuit assignment and receptacle placement should be coordinated with a local electrician. Local electrician is responsible for circuit loading and code compliance.**
- **Consult with local authority having jurisdiction (AHJ) for requirements regarding controlled receptacles before placing orders and installation.**

Circuit Symbol	Circuit 1	Circuit 2	Circuit 3	Circuit 4
3 Circuit	I	II	III	NA
4 Circuit 2+2	1	2	3	4
4 Circuit 3+1	A	B	C	D

To Order, Specify:

- 1) Product number.
- 2) Trim color.

TR-K	Charcoal
TR-G	Gray Tone
TR-TW	Plaster
TR-AA	Putty
TR-E	Smoke

Description	Circuit Access	Receptacle Indicator	Ground Type	Receptacle without Controlled Symbol	Price	Receptacle with Controlled Symbol	Price
3-Circuit							
	Circuit 1	1	Common	EUEP-2031-GSOS	\$584.52	EUEP-2031-GCOS	\$ 597.61
	Circuit 2	2		EUEP-2032-GSOS	584.52	EUEP-2032-GCOS	597.61
	Circuit 3	3		EUEP-2033-GSOS	584.52	EUEP-2033-GCOS	597.61
	Circuit 1	1	Isolated	EUEP-2031-ISOS	\$595.35	EUEP-2031-ICOS	\$608.72
	Circuit 2	2		EUEP-2032-ISOS	595.35	EUEP-2032-ICOS	608.72
	Circuit 3	3		EUEP-2033-ISOS	595.35	EUEP-2033-ICOS	608.72
4-Circuit, 2+2							
	Circuit 1	1	Common	EUEP-2021-GSOS	\$ 674.52	EUEP-2021-GCOS	\$ 687.61
	Circuit 2	2		EUEP-2022-GSOS	674.52	EUEP-2022-GCOS	687.61
	Circuit 3	3		EUEP-2023-GSOS	674.52	EUEP-2023-GCOS	687.61
	Circuit 4	4		EUEP-2024-GSOS	674.52	EUEP-2024-GCOS	687.61
	Circuit 1	1	Isolated	EUEP-2021-ISOS	\$685.35	EUEP-2021-ICOS	\$698.72
	Circuit 2	2		EUEP-2022-ISOS	685.35	EUEP-2022-ICOS	698.72
	Circuit 3	3		EUEP-2023-ISOS	685.35	EUEP-2023-ICOS	698.72
	Circuit 4	4		EUEP-2024-ISOS	685.35	EUEP-2024-ICOS	698.72
4-Circuit, 3+1							
	Circuit 1	A	Common	EUEP-2041-GSOS	\$ 674.52	EUEP-2041-GCOS	\$ 687.61
	Circuit 2	B		EUEP-2042-GSOS	674.52	EUEP-2042-GCOS	687.61
	Circuit 3	C		EUEP-2043-GSOS	674.52	EUEP-2043-GCOS	687.61
	Circuit 4	D		EUEP-2044-GSOS	674.52	EUEP-2044-GCOS	687.61
	Circuit 1	A	Isolated	EUEP-2041-ISOS	\$685.35	EUEP-2041-ICOS	\$698.72
	Circuit 2	B		EUEP-2042-ISOS	685.35	EUEP-2042-ICOS	698.72
	Circuit 3	C		EUEP-2043-ISOS	685.35	EUEP-2043-ICOS	698.72
	Circuit 4	D		EUEP-2044-ISOS	685.35	EUEP-2044-ICOS	698.72

Electrical Components

Hardware

Top Feed — Hardware

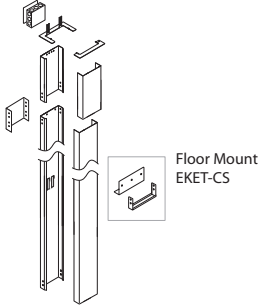

EKET-C000-CS
Class YA

Features

- Includes one electrical box, ceiling bezel plate, pole and hardware.
- For connection to the electrical source located in space above a drop ceiling.
- For routing and cabling capacities, refer to Specification Guide.
- Removable cover on poles provides access to pathway.
- Top feed pole dimensions: 2.5"(64mm) x 8"(203mm).

Specification Tips

- **Not for use with power sources other than 120 volt 60 hertz.**
- Top Feed may interfere with Tool Rail or Screen applications.
- Floor mount Top Feed mounts to floor, attaches to desking worksurface at any side and ceiling.
- Floor attachment hardware is field supplied.
- Application may require approval of local authority having jurisdiction (AHJ); ensure compliance before placing orders and installation.

To Order, Specify:

- 1) Product number.
- 2) Trim color.

Height	Ceiling Height	Pole Length	Number	Trim	
				A	B
Floor Mount Height					
Hardware	10'(3048mm)	138"(3505mm)	EKET-C000-CS	\$545.88	\$632.70
	12'(3658mm)	150"(3810mm)	EKET-E400-CS	574.82	676.12

Hardware Kit

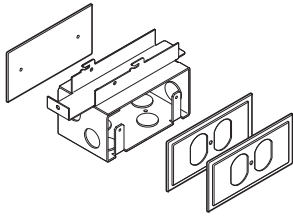

EKEP-0000-C
Class YA

Features

- Includes one electrical box with 0.5"(13mm) knockouts, two receptacle cover plates, one blank cover plate and mounting hardware.
- Attaches to separately specified non-powered Utility Tray.
- Field installed.

Specification Tips

- **Conduit, fittings, wiring and receptacles are field supplied.**
- For single sided applications, specify service part #6240-4207 separately.

To Order, Specify:

- 1) Product number.
- 2) Trim color.

Number	Trim	
	A	B
EKEP-0000-C	\$226.49	\$236.82

Cover Plates

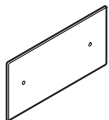

EUAP-0000-CB

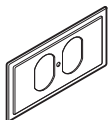

EUAP-0000-CR
Class YA

Feature

- Includes four blank cover plates or receptacle covers and hardware.

Specification Tips

- For hardware kit applications.
- Receptacle cover option (R) to be used with duplex receptacle. (Duplex receptacle field supplied).

To Order, Specify:

- 1) Product number.

1 Cover Options:

- B** Blank cover
- R** Receptacle cover (add **\$10.33** list)

- 2) Trim color.

Number	1	Trim	
		A	B
EUAP-0000-C		\$41.17	\$51.50

Electrical Accessories

Base Feed Cover — Vertical

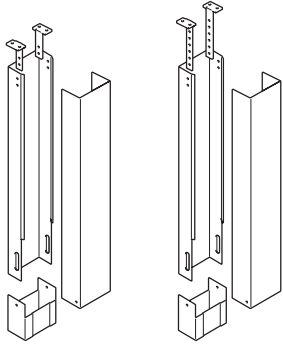

EUAC-0000-F
Class YA

EUAC-0000-A

Features

- Includes 2-piece base feed cover and attachment hardware.
- Optional base feed cover is used to conceal metal conduit and data cables.
- Base feed dimension: 2"(51mm) x 4.25"(108mm).

Specification Tips

- Used to route power and data from floor, columns and walls to bottom of horizontal surface.
- Mounts under horizontal surface and attaches to floor.
- Floor attachment hardware is field supplied.

To Order, Specify:

- 1) Product number.
- 2) Trim color.

Description	Bottom of surface to floor	Number	Trim	
			A	B
Fixed Height	27.5"-28.5"(699mm-724mm)	EUAC-0000-F	\$262.06	\$278.83
Adjustable Height	25.5"-32.5"(648mm-826mm)	EUAC-0000-A	262.06	278.83

Intuity Benching Resources

Surfaces Materials

Index

Warranty

Surface Materials

Finish Color Legend

Wood

Grade A

Double Cut

2P-RL	Applegate
CQ-HKL	Auburn
CQ-HBF	Clove
WE-RD	Dune
WJ-RE	Ebony
2N-RL	Echo
W3-HR	Harbor
WE-RT	Melba
W4-PB	Pebble
CQ-WG	Walnut Grove

Grade B

Cherry

VC-CA1	Amber
VC-HKF	Burgundy
VC-W23	American
VC-W33	Caramel
VC-W30	Heritage
VC-W32	Pacific
VC-HKA	Toffee

Maple

VP-LM	Light
VP-N	Natural

Maple Quarter Cut

NM-N	Natural
------	---------

Oak

VJ-HKC	Urban
--------	-------

Rift Cut White Oak

NR-W15	Espresso
NR-W40	Mocha

Walnut

VR-CPK	Bourbon
VR-HKG	Colombian
VR-W15	Espresso
VR-W31	Retro

Walnut Quarter Cut

NW-W35	Clear
NW-W31	Retro

HPL

Grade A

Solid Color

H-34	Beige
H-AK	Chalk
H-8J	Charcoal
H-3J	Graphite
H-62	Gray Tone
H-WL	Linen
H-3P	Platinum
H-AA	Putty
H-3E	Smoke

Patterned

H-P1	Linen Casual
H-P2	Linen Classic
H-P3	Linen Crisp
H-P4	Linen Flax

Wood Grain

H-B06	Brazilwood
H-E79	Colombian Walnut
H-DYP	New Age Oak
H-AE	Maple
H-E15	River Cherry
H-C09	Williamsburg Cherry

Grade B

Premium Wood Grain

H-C8	Blonde Modern Cherry
H-D1	Daintree
H-KP	Field Elm
H-KN	Grey Elm
H-KM	Landmark Wood
H-D2	Mocha Modern Cherry
H-KL	Neo Walnut
H-KR	Phantom Ecu
H-KS	Phantom Pearl
H-C9	Spiced Modern Cherry

Grade E

Premium

H-C1	Hay
H-C2	Drift
H-C3	Pecan
H-C4	Molasses
H-C5	Mineral
H-C6	Hatch
H-C7	Tanned

Edgeband

Solid Color

HP-34	Beige
HP-AK	Chalk
HP-8J	Charcoal
HP-3J	Graphite
HP-62	Gray Tone
HP-WL	Linen
HP-3P	Platinum
HP-AA	Putty
HP-3E	Smoke

Patterned Edgeband

HP-P1	Linen Casual
HP-P2	Linen Classic
HP-P3	Linen Crisp
HP-P4	Linen Flax

Wood Grain

HP-C8	Blonde Modern Cherry
HP-B06	Brazilwood
HP-E79	Colombian Walnut
HP-D1	Daintree
HP-KP	Field Elm
HP-KN	Grey Elm
HP-KM	Landmark Wood
HP-AE	Maple
HP-D2	Mocha Modern Cherry
HP-KL	Neo Walnut
HP-DYP	New Age Oak
HP-KR	Phantom Ecu
HP-KS	Phantom Pearl
HP-E15	River Cherry
HP-C9	Spiced Modern Cherry
HP-C09	Williamsburg Cherry

Ply-Edge

HP-PW	Ply-Edge
-------	----------

Premium

HP-C1	Hay
HP-C2	Drift
HP-C3	Pecan
HP-C4	Molasses
HP-C5	Mineral
HP-C6	Hatch
HP-C7	Tanned

Trim

Grade A

Smooth

TR-R	Beige
TR-AK	Chalk
TR-K	Charcoal
TR-C1	Cocoa
TR-J	Graphite
TR-G	Gray Tone
TR-AA	Putty
TR-E	Smoke
TR-PLS	Smooth Plaster
TR-FM	Snow

Textured

TR-TG	Grout
TR-TF	Pitch
TR-TW	Plaster

Grade B

Smooth

TR-1C	Accent Blue
TR-1E	Accent Orange
TR-1G	Blue Jay
TR-1R	Brownstone
TR-1N	Night
TR-1Q	Park
TR-RR	Rusty Red
TR-1M	Sable
TR-1J	Sky Blue
TR-1K	Wren

Smooth Metallic

TR-BN	Bronze
TR-BG	Light Bronze
TR-MC	Metallic Champagne
TR-MG	Metallic Gunmetal
TR-LE	Metallic Silver*

Textured Metallic

TR-AR	Argent
TR-HE	Hellenic

ALERT: These materials are current, however they are being considered for future obsolescence due to low volume.

Wood

VJ-W42	Brindle
2R-RL	Butternut
NW-W15	Espresso
NP-W08	Golden
NP-W07	Light
NX-U	Medium
VJ-W05	Natural
VR-W12	Naturally Walnut
WC-RW	Wenge

HPL

H-AM	Amber Cherry
H-AD	Medium Cherry

Edgeband

HP-AM	Amber Cherry
HP-AD	Medium Cherry

Trim

TR-1F	Accent Red
TR-CTS	Chartreuse
TR-1H	Terra

Surface Materials

Fabrics/Color Legend

Vertical Fabrics

Grade A

- (6X) Chevron
- (35) Etch
- (L6) Highlands
- (C1) Striae
- (PY) Tailored
- (3A) Tellure

Grade B

- (33) Camp
- (L5) Classic
- (34) Fields
- (6) Hue
- (32) Pica
- (PV) Ritz
- (WS) Shimmer

Grade C

- (SW) Sisal
- (4S) Thorman

* For most current finish and fabric availability please reference surfaces.haworth.com.

Haworth+

For information on the Haworth+ alliance program, including images and product availability, please refer to: Haworth.com > Surface Collection > Haworth+ Library

Customer's Own Material (COM)

For general Customer's Own Material (COM) information including processes and forms, please refer to: Haworth.com > Surface Collection > Resources > COM
 For information on approved COM's, please refer to: Haworth.com > Surface Collection > COM Library

Forest Stewardship Council® (FSC®) Statement:

In our continuing support of sustainable forestry and responsible purchasing, Haworth North America is offering FSC certified wood products at no up-charge. By providing FSC certified material, Haworth is supporting our client's green building goals and demonstrating our collective commitment to source materials more sustainably.

Haworth will provide to you the necessary FSC-certified paperwork with your shipment. For more information, FAQs, and a complete FSC product list (including product exceptions), go to the Library and search FSC.

Haworth FSC Trademark License #FSC-C002821

Index

Products are listed alphabetically in this index by alpha-numeric prefix/suffix codes.

Product Code	Product Description	Page
4TEB-1	Electrical Components – Base Feed Module Hardwire Connection	26
4TEB-15	Electrical Components – Single Circuit Base Feed – Receptacle Connection — 3-Circuit and 4-Circuit	25
4TEB-20	Electrical Components – Single Circuit Base Feed – Receptacle Connection with Power Cord — 3-Circuit and 4-Circuit	25
EBEC-0000-F	Accessories – 120° Infeed Cover	23
EKEP-0000-C	Electrical Components – Hardwire Kit	31
EKET-0000-2S	Electrical Components – Top Feed	28
EKET-0000-3S	Electrical Components – Top Feed	28
EKET-0000-4S	Electrical Components – Top Feed	28
EKET-0000-CS	Electrical Components – Top Feed — Hardwire	31
EUAC-0000-A	Electrical Accessories – Base Feed Cover — Vertical	32
EUAC-0000-F	Electrical Accessories – Base Feed Cover — Vertical	32
EUAP-0000-CB	Electrical Components – Cover Plates	31
EUAP-0000-CR	Electrical Components – Cover Plates	31
EUEB-0000-2HY	Electrical Components – Base Feed Module — Hardwire Connection	24
EUEB-0000-3HY	Electrical Components – Base Feed Module — Hardwire Connection	24
EUEB-0000-4HY	Electrical Components – Base Feed Module — Hardwire Connection	24
EUEC-0000	Accessories – Double-Sided Utility Tray End Covers	23
EUEH-0087-2	Electrical Components – Infeed Harness	24
EUEH-0087-3	Electrical Components – Infeed Harness	24
EUEH-0087-4	Electrical Components – Infeed Harness	24
EUEJ-0024-2	Electrical Components – Jumper	27
EUEJ-0024-3	Electrical Components – Jumper	27
EUEJ-0024-4	Electrical Components – Jumper	27
EUEJ-0064-2WF	Electrical Components – Internal Power Base™ AI Base Feed	26
EUEJ-0064-3WF	Electrical Components – Internal Power Base™ AI Base Feed	26
EUEJ-0064-4WF	Electrical Components – Internal Power Base™ AI Base Feed	26
EUEK-2S	Electrical Components – Utility Tray Power Retrofit Kit	27
EUEK-3S	Electrical Components – Utility Tray Power Retrofit Kit	27
EUEK-4S	Electrical Components – Utility Tray Power Retrofit Kit	27
EUER-15	Electrical Components – Triplex Receptacle – 15 Amp	29
EUER-20	Electrical Components – Triplex Receptacle – 20 Amp	30
WBCZ-S	Worksurfaces – Corner, 120° Wrap-Around	22
WBDA-SC	Worksurfaces – Rectangular Bench End Worksurface	21
WBRA-SC	Worksurfaces – Rectangular Worksurface — No Access Hatch	19
WBRA-SS	Worksurfaces – Rectangular Worksurface – For Use with Access Hatches	20
WBRB-SC	Worksurfaces – Rectangular Return Worksurface	21
ZBA2-0000-PNFG	Leg Kits – Bench End Leg Kit	18
ZBA2-0024-HRFG	Leg Kits – Return Leg Kit	18
ZBBP-0000-PN	Accessories – Tie Plate	23
ZBCZ-2442-SAGH	120° Single Sided Starter Kits – 120° Single Sided Starter Kit	15
ZBCZ-2442-SIGH	120° Single Sided Starter Kits – 120° Single Sided Starter Kit	15
ZBCZ-4842-AWGH	120° Double Sided Three Pack Add-on Kit – 120° Double Sided Three Pack Add-on Kit	17
ZBCZ-4842-AXGH	120° Double Sided Three Pack Add-on Kit – 120° Double Sided Three Pack Add-on Kit	17
ZBCZ-4842-AYGH	120° Double Sided Three Pack Add-on Kit – 120° Double Sided Three Pack Add-on Kit	17
ZBCZ-4842-AZGH	120° Double Sided Three Pack Add-on Kit – 120° Double Sided Three Pack Add-on Kit	17
ZBCZ-4842-SAGH	120° Double Sided Three Pack Starter Kit – 120° Double Sided Three Pack Starter Kit	16
ZBCZ-4842-SIGH	120° Double Sided Three Pack Starter Kit – 120° Double Sided Three Pack Starter Kit	16
ZBE2-0000-PNFG	Leg Kits – Bench End Leg Kit	18
ZBI2-0030-HNFG	Leg Kits – Return Leg Kit	18
ZBRA-0000-D	Accessories – Access Hatch Gap Filler	23

Index

<u>Product Code</u>	<u>Product Description</u>	<u>Page</u>
ZBRA-2448-ASGH	Single Sided Kits – Single Sided Add-On Kit10
ZBRA-2448-ATGH	Single Sided Kits – Single Sided Add-On Kit10
ZBRA-2448-SAGH	Single Sided Kits – Single Sided Starter Kit9
ZBRA-2448-SIGH	Single Sided Kits – Single Sided Starter Kit9
ZBRA-4848-AFGH	Double Sided Kits – Double Sided Add-On Kit13
ZBRA-4848-ASGH	Double Sided Kits – Double Sided Add-On Kit13
ZBRA-4848-ATGH	Double Sided Kits – Double Sided Add-On Kit13
ZBRA-4848-SAGH	Double Sided Kits – Double Sided Starter Kit11
ZBRA-4848-SIGH	Double Sided Kits – Double Sided Starter Kit11

Product Compatibility and Limited Warranty Policy

Great Expectations

You have them as a Haworth customer and so do we. And because we value our customers, we cover our products with the Haworth North America Product Compatibility and Limited Warranty Policy.

Our Commitment To Product Compatibility – Integrated Product Platforms

As a market leader in the design and manufacture of workspaces that adapt to change, we strive to maintain product compatibility within our various generations of integrated product platforms. This benefits the customer who desires to update or modify their work environment. It also benefits the customer needing to replace a product due to damage or other reasons but which is no longer manufactured or is otherwise unavailable, such as a fabric or finish that is discontinued because of changing market preferences. In both circumstances, we often can provide products with comparable function and performance.

Our Commitment To Product Quality – The Haworth North America Limited Warranty

To ensure customer satisfaction and peace of mind, we stand behind our products with the Haworth North America Limited Warranty. To review the current version of the limited warranty including its terms and conditions, please go to:

www.haworth.com/warranty or contact OneTouch@Haworth.com or 1 877 429 6784.

Warranty Requests or Questions

For questions or service requests pertaining to the Haworth Limited Warranty, please contact your Haworth dealer.

If you are unsure who your dealer is, please contact **OneTouch@Haworth.com or 1 877 429 6784.**

Terms of Sale

The Terms of Sale apply to all products in the North America Price Lists. To review the current version of the North American Terms of Sale, please go to:

www.haworth.com/terms-of-sale or contact OneTouch@Haworth.com or 1 877 429 6784.

